

G-WIN Slim IP65 Panel PC

Freescale® Cortex® A9 i.MX6 Dual Core 1 GHz (Optional Quad Core)



P-CAP Touch

W07FA3S-GSO1
W10FA3S-GSH1(HB)
R10FA3S-GST2
R12FA3S-GSM2(HB)
R15FA3S-GSC3(HB)

User Manual

Version 1.3

CONTENTS

PREFACE..... - 4 -

ABOUT THIS USER MANUAL..... - 12 -

CHAPTER 1: INTRODUCTION - 14 -

 1.1 Product Features..... - 14 -

 1.2 Package Contents..... - 15 -

 1.3 Schematics and Dimensions - 16 -

CHAPTER 2: GETTING STARTED - 22 -

 2.1 Turning on and off Your Device - 22 -

2.2 Connecting to Other Devices - 23 -

2.2.1 Diagram..... - 23 -

2.2.2 Connector Description..... - 24 -

 2.3 Configuring Serial COM Port Settings - 28 -

CHAPTER 3: OPERATING THE DEVICE..... - 31 -

 3.1 Operating System..... - 31 -

 3.2 Multi-Touch..... - 32 -

 3.3.1 Setting up the Device - 33 -

 3.3.2 Home Screen - 33 -

 3.3.3 Quick Settings..... - 35 -

 3.4 Ethernet - 37 -

 3.4.1 Configuring Ethernet Settings - 38 -

 3.4.2 Checking Ethernet Settings - 39 -

 3.5 Winmate® Home Manager (WHM) - 40 -

 3.5.1 How to Lock Applications - 40 -

 3.5.2 How to Unlock Applications - 44 -

 3.5.3 How to Change Password..... - 45 -

CHAPTER 4: SOFTWARE INSTALLATION - 47 -

 4.1 Android Debug Bridge (ADB) Driver Installation - 47 -

 4.1.1 Disabling Driver Signature on Windows 8..... - 48 -

 4.1.2 ADB Driver Installation - 53 -

 4.2 Installing Android Debug Bridge (ADB)..... - 57 -

4.3 OTA Update Guide - 58 -

4.4 OS Image Update Guide - 62 -

CHAPTER 5: MOUNTING - 64 -

5.1 Cable Mounting Considerations - 64 -

5.2 Safety Precautions - 65 -

5.3 Mounting Guide - 65 -

 5.3.1 VESA Mounting - 66 -

 5.3.2 Panel Mounting - 67 -

CHAPTER 6: TECHNICAL SUPPORT - 69 -

6.1 Software Developer Support - 69 -

6.2 Problem Report Form - 70 -

APPENDIX A: PRODUCT SPECIFICATIONS - 72 -

PREFACE

Copyright Notice

No part of this document may be reproduced, copied, translated, or transmitted in any form or by any means, electronic or mechanical, for any purpose, without the prior written permission of the original manufacturer.

Trademark Acknowledgement

Brand and product names are trademarks or registered trademarks of their respective owners.

Disclaimer

We reserve the right to make changes, without notice, to any product, including circuits and/or software described or contained in this manual in order to improve design and/or performance. We assume no responsibility or liability for the use of the described product(s) conveys no license or title under any patent, copyright, or masks work rights to these products, and make no representations or warranties that these products are free from patent, copyright, or mask work right infringement, unless otherwise specified. Applications that are described in this manual are for illustration purposes only. We make no representation or guarantee that such application will be suitable for the specified use without further testing or modification.

Warranty

Our warranty guarantees that each of its products will be free from material and workmanship defects for a period of one year from the invoice date. If the customer discovers a defect, we will, at his/her option, repair or replace the defective product at no charge to the customer, provide it is returned during the warranty period of one year, with transportation charges prepaid. The returned product must be properly packaged in its original packaging to obtain warranty service. If the serial number and the product shipping data differ by over 30 days, the in-warranty service will be made according to the shipping date. In the serial numbers the third and fourth two digits give the year of manufacture, and the fifth digit means the month (e. g., with A for October, B for November and C for December).

For example, the serial number 1W16Axxxxxxx means October of year 2016.

Customer Service

We provide a service guide for any problem by the following steps: First, visit the website of our distributor to find the update information about the product. Second, contact with your distributor, sales representative, or our customer service center for technical support if you need additional assistance.

You may need the following information ready before you call:

- Product serial number
- Software (OS, version, application software, etc.)
- Description of complete problem
- The exact wording of any error messages

In addition, free technical support is available from our engineers every business day. We are always ready to give advice on application requirements or specific information on the installation and operation of any of our products.

Advisory Conventions

Four types of advisories are used throughout the user manual to provide helpful information or to alert you to the potential for hardware damage or personal injury. These are Notes, Important, Cautions, and Warnings. The following is an example of each type of advisory.



NOTE:

A note is used to emphasize helpful information



IMPORTANT:

An important note indicates information that is important for you to know.



CAUTION/ ATTENTION

A Caution alert indicates potential damage to hardware and explains how to avoid the potential problem.

Une alerte d'attention indique un dommage possible à l'équipement et explique comment éviter le problème potentiel.



WARNING!/ AVERTISSEMENT!

An Electrical Shock Warning indicates the potential harm from electrical hazards and how to avoid the potential problem.

Un Avertissement de Choc Électrique indique le potentiel de chocs sur des emplacements électriques et comment éviter ces problèmes.



ALTERNATING CURRENT / MISE À LE TERRE!

The Protective Conductor Terminal (Earth Ground) symbol indicates the potential risk of serious electrical shock due to improper grounding.

Le symbole de Mise à Terre indique le risqué potentiel de choc électrique grave à la terre incorrecte.

Safety Information

WARNING! / AVERTISSEMENT!

Always completely disconnect the power cord from your chassis whenever you work with the hardware. Do not make connections while the power is on. Sensitive electronic components can be damaged by sudden power surges. Only experienced electronics personnel should open the PC chassis.



Toujours débrancher le cordon d'alimentation du chassis lorsque vous travaillez sur celui-ci. Ne pas brancher de connexions lorsque l'alimentation est présente. Des composantes électroniques sensibles peuvent être endommagées par des sauts d'alimentation. Seulement du personnel expérimenté devrait ouvrir ces chassis.

CAUTION/ATTENTION

Always ground yourself to remove any static charge before touching the CPU card. Modern electronic devices are very sensitive to static electric charges. As a safety precaution, use a grounding wrist strap at all times. Place all electronic components in a static-dissipative surface or static-shielded bag when they are not in the chassis.



Toujours vérifier votre mise à la terre afin d'éliminer toute charge statique avant de toucher la carte CPU. Les équipements électroniques modernes sont très sensibles aux décharges d'électricité statique. Toujours utiliser un bracelet de mise à la terre comme précaution. Placer toutes les composantes électroniques sur une surface conçue pour dissiper les charge, ou dans un sac anti-statique lorsqu'elles ne sont pas dans le chassis.

Safety Precautions

For your safety carefully read all the safety instructions before using the device. Keep this user manual for future reference.

- Always disconnect this equipment from any AC outlet before cleaning. Do not use liquid or spray detergents for cleaning. Use a damp cloth.
- For pluggable equipment, the power outlet must be installed near the equipment and must be easily accessible.
- Keep this equipment away from humidity.
- Put this equipment on a reliable surface during installation. Dropping it or letting it fall could cause damage.
- The openings on the enclosure are for air convection and to protect the equipment from overheating.



CAUTION/ATTENTION

Do not cover the openings!

Ne pas couvrir les ouvertures!

- Before connecting the equipment to the power outlet make sure the voltage of the power source is correct.
- Position the power cord so that people cannot step on it. Do not place anything over the power cord.
- If the equipment is not used for a long time, disconnect it from the power source to avoid damage by transient over-voltage.
- Never pour any liquid into an opening. This could cause fire or electrical shock.
- Never open the equipment. For safety reasons, only qualified service personnel should open the equipment.
- All cautions and warnings on the equipment should be noted.

***Let service personnel to check the equipment in case any of the following problems appear:**

- The power cord or plug is damaged.
 - Liquid has penetrated into the equipment.
 - The equipment does not work well or you cannot get it to work according to the user manual.
 - The equipment has been dropped and damaged.
 - The equipment has obvious signs of breakage.
- Do not leave this equipment in an uncontrolled environment where the storage temperature is below -20°C (-4°F) or above 60°C (140°F). It may damage the equipment.



CAUTION/ATTENTION

Use the recommended mounting apparatus to avoid risk of injury.
Utiliser l'appareil de fixation recommandé pour éliminer le risque de blessure.



WARNING!/ AVERTISSEMENT!

Only use the connection cords that come with the product. When in doubt, please contact the manufacturer.
Utiliser seulement les cordons d'alimentation fournis avec le produit. Si vous doutez de leur provenance, contactez le fabricant.







WARNING!/ AVERTISSEMENT!

Always ground yourself against electrostatic damage to the device.
Toujours vérifier votre mise à la terre afin que l'équipement ne se décharge pas sur vous.

- Cover workstations with approved anti-static material. Use a wrist strap connected to a work surface and properly grounded tools and equipment.
- Use anti-static mats, heel straps, or air ionizer for added protection.
- Handle electrostatic-sensitive components, PCB's and assemblies by the case or the edge of the board.
- Avoid contact with pins, leads, or circuitry.
- Turn off power and input signals before inserting and removing connectors or test equipment.
- Keep the work area free of non-conductive materials, such as ordinary plastic assembly aids and Styrofoam.
- Use filed service tools, such as cutters, screwdrivers, and vacuum cleaners that are conductive.
- Always put drivers and PCB's component side on anti-static foam.

Important Information

Countries/ Area	Symbol	This equipment complies with essential requirements of:
 European Union		Electromagnetic Compatibility Directive(2014/30/EU) Low Voltage Directive (2014/35/EU) Restrictions of the use of certain hazardous substances (RoHS) Directive (2011/65/EU)
 USA		FCC Part 15 Subpart B Regulations Class B

Federal Communications Commission Radio Frequency Interface Statement



This device complies with part 15 FCC rules.

Operation is subject to the following two conditions:

- This device may not cause harmful interference.
- This device must accept any interference received including interference that may cause undesired operation.

This equipment has been tested and found to comply with the limits for a class "B" digital device, pursuant to part 15 of the FCC rules. These limits are designed to provide reasonable protection against harmful interference when the equipment is operated in a commercial environment. This equipment generates, uses, and can radiate radio frequency energy and, if not installed and used in accordance with the instruction manual, may cause harmful interference to radio communications. Operation of this equipment in a residential area is likely to cause harmful interference in which case the user will be required to correct the interference at him own expense.

European Union



This equipment is in conformity with the requirement of the following EU legislations and harmonized standards. Product also complies with the Council directions.

Electromagnetic Compatibility Directive (2014/30/EU)

- EN55024: 2010/ A1: 2015
 - IEC61000-4-2: 2009
 - IEC61000-4-3: 2006+A1: 2007+A2: 2010
 - IEC61000-4-4: 2012
 - IEC61000-4-5: 2014
 - IEC61000-4-6: 2014
 - IEC61000-4-8: 2010
 - IEC61000-4-11: 2004
- EN55032: 2012/AC:2013
- EN61000-3-2:2014
- EN61000-3-3:2013

Low Voltage Directive (2014/35/EU)

- EN 60950-1:2006/A11:2009/A1:2010/A12:2011/ A2:2013

ABOUT THIS USER MANUAL

This User Manual provides information about using the Winmate® G-WIN Slim IP65 Panel PC (P-CAP) with Freescale® Cortex® A9 i.MX6 Dual Core (Optional Quad Core) processor. This User Manual applies to the G-WIN Slim IP65 Panel PC (P-CAP) – W07FA3S-GSO1, W10FA3S-GSH1, R10FA3S-GST2, R12FA3S-GSM2(HB), R15FA3S-GSC3(HB).

The documentation set for the G-WIN Slim IP65 Panel PC (P-CAP) provides information for specific user needs, and includes:

- **G-WIN Slim IP65 Panel PC (P-CAP) Quick Start Guide** - describes how to get the Panel PC up and running.
- **G-WIN Slim IP65 Panel PC (P-CAP) User Manual** – contains detailed description on how to use the Panel PC, its components and features.



NOTE:

Some pictures in this guide are samples and can differ from actual product.

Document Revision History

Version	Date	Note
1.0	10-Jan-2017	Initial Release
1.1	28-Nov-2017	Update OS to Android 6.0
1.2	5-Mar-2018	Revise mechanical design of R10FA3S-GST2

INTRODUCTION

This chapter gives you product overview, describes features and hardware specification. You will find all accessories that come with the HMI device in the packing list. Mechanical dimensions and drawings included in this chapter.



CHAPTER 1: INTRODUCTION

Congratulations on purchasing Winmate® G-WIN Slim IP65 with P-CAP Panel PC. The elegantly designed, yet rugged, industrial grade G-WIN S65 series is designed for usability with brilliant true-flat screens, which offer superior readability and Projected Capacitive Multi-Touch (P-CAP) technology, available in 7", 10.1", 12.1" and 15" options.

G-WIN Slim IP65 Panel PC operates on Freescale® Cortex® A9 i.MX6 Dual Core 1GHz (optional Quad Core) processor and support Android, Linux Kernel or Ubuntu operating systems. The Panel PC features Projected Capacitive Multi-Touch (P-CAP). These models are full IP 65 dustproof and waterproof and have M12 connectors.

1.1 Product Features



Winmate® G-WIN Slim IP65 with P-CAP Panel PC features:

- 7", 10.1", 10.4", 12.1" and 15"
- Freescale® Cortex® A9 i.MX6 Dual Core 1GHz (optional Quad Core)
- Android, Linux Kernel or Ubuntu OS
- Fanless cooling system and Ultra-low power consumption
- Onboard 1GB LPDDR3
- Onboard 16GB eMMC Flash
- Full IP65
- 1 x LAN, 1 x RS232, 1 x USB, 1 x USB OTG, 1 x Console, 1 x MicroSD Card Slot

1.2 Package Contents

Carefully remove the box and unpack your HMI device. Please check if all the items listed below are inside your package. If any of these items are missing or damaged contact us immediately.

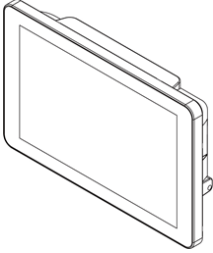
Standard factory shipment list:

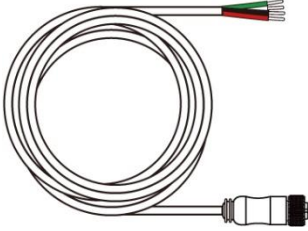
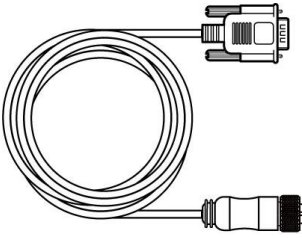
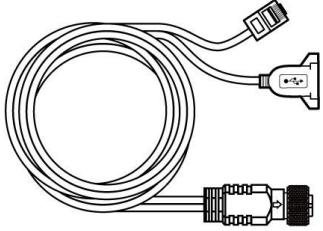
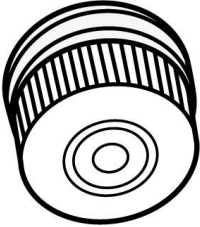
		
Panel PC	Quick Start Guide (Hardcopy)	Driver CD & User Manual
Varies by product specifications	915211101000	91711111102Y
		
M12 Power Cable	M12 Serial Interface Cable	M12 USB/ LAN Cable
94J004L040K1	94G0123090Q0	94E0128040K0
		
I/O Protective Cap x 3		
60Y031131000		

1.3 Schematics and Dimensions

W07FA3S-GS01

Unit: mm

Dimensions: 189.4 x 145.4 x 39.8

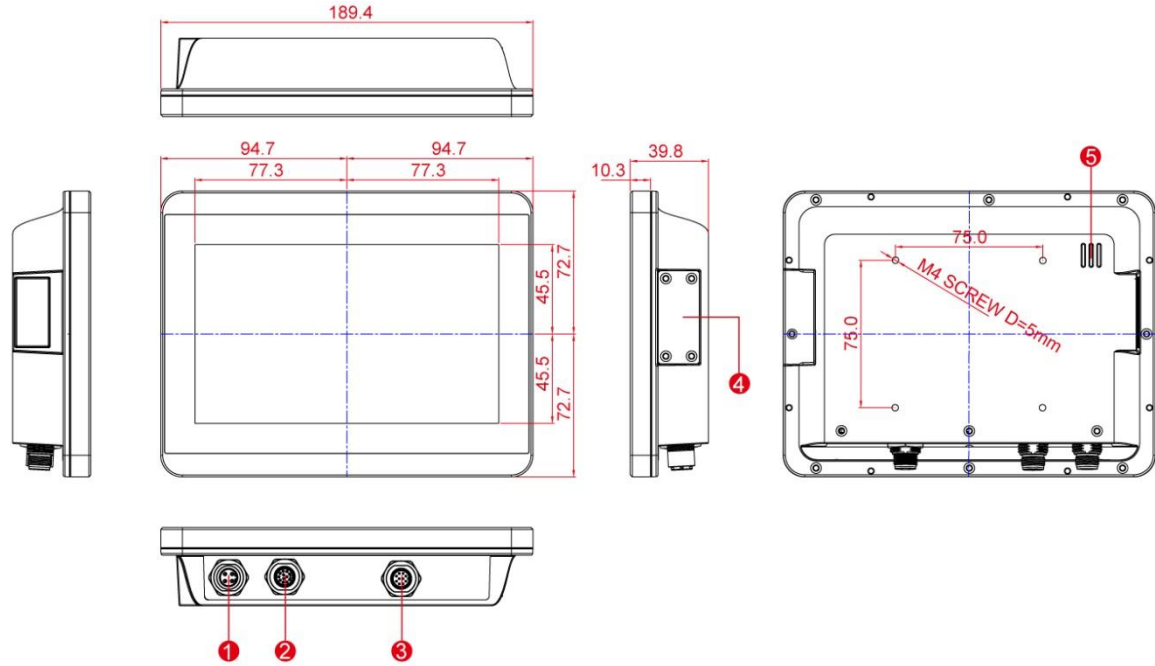

No	Description	No	Description
①	9~24V DC (M12 Type)	④	USB OTG, Console Port, MicroSD
②	LAN, USB (M12 Type)	⑤	1 Watt Speaker
③	RS232 (M12 Type)		

W10FA3S-GSH1(HB)

Unit: mm
 Dimensions: 263.28 x 173.6 x 40.2

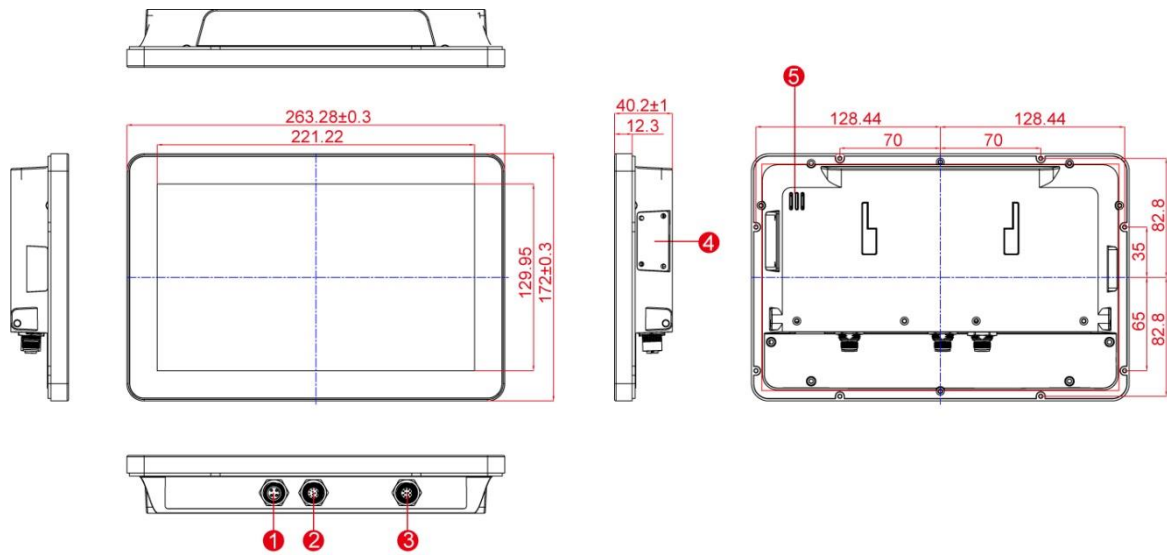

No	Description	No	Description
①	12V DC (M12 Type)	④	USB OTG, Console Port, MicroSD
②	LAN, USB (M12 Type)	⑤	1 Watt Speaker
③	RS232 (M12 Type)		

R10FA3S-GST2

Unit: mm

Dimensions: 263.28 x 197.8 x 43

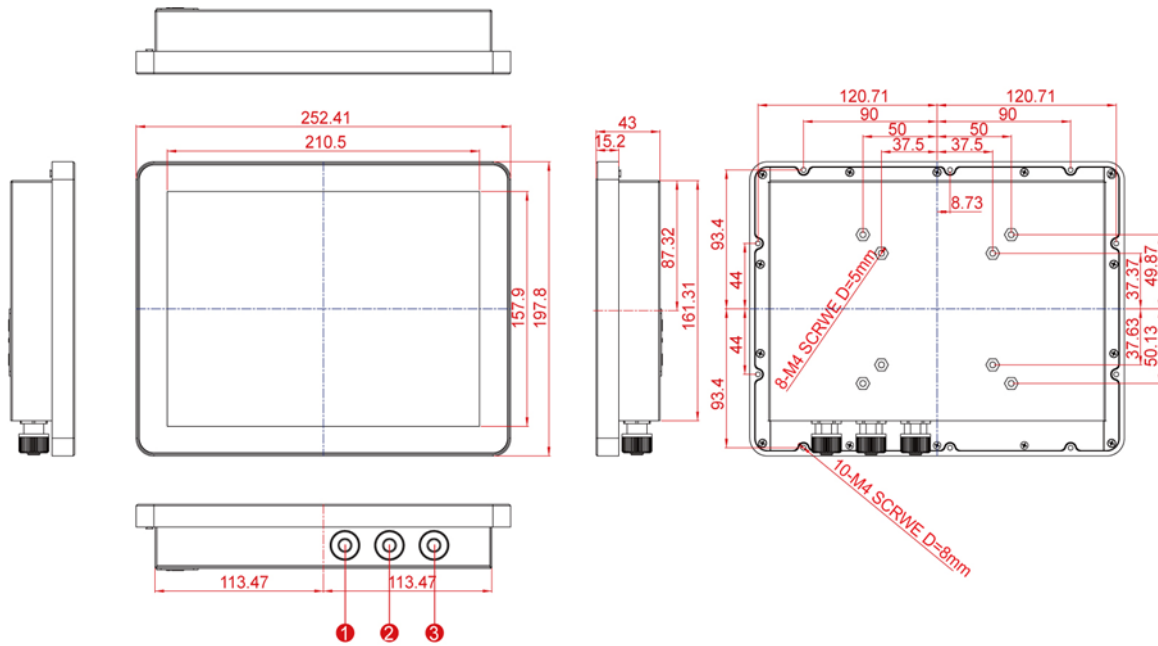

Nº	Description	Nº	Description
①	12V DC (M12 Type)	③	LAN, USB (M12 Type)
②	RS232 (M12 Type)		

R12FA3S-GSM2(HB)

Unit: mm
 Dimensions: 296.2 x 226.7 x 45.5

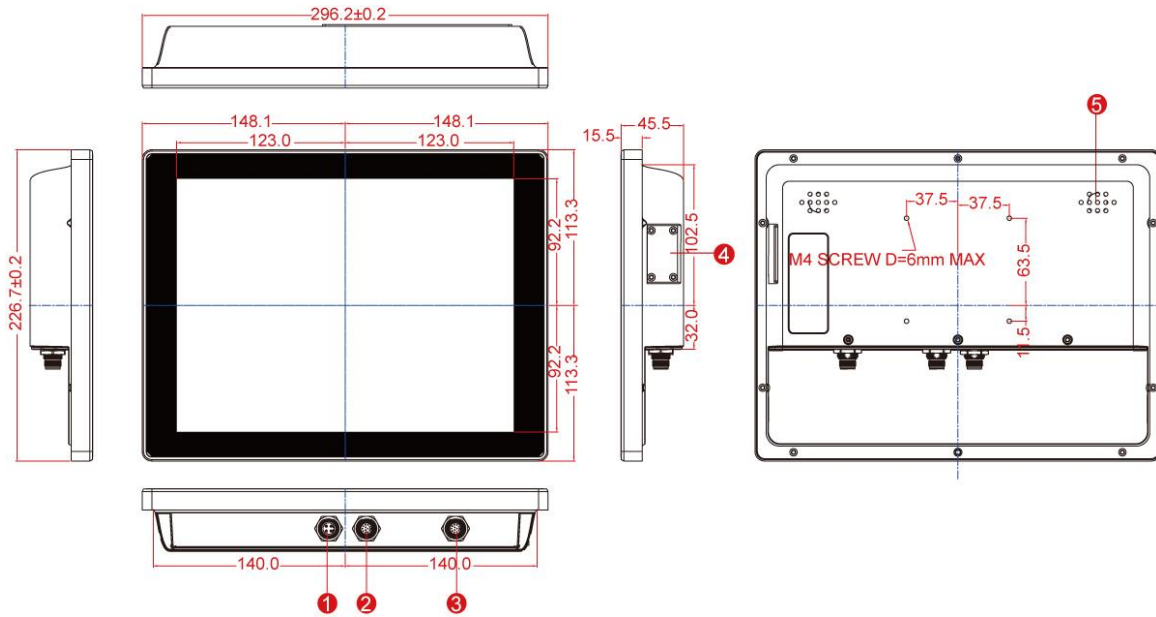

No	Description	No	Description
①	12V DC (M12 Type)	④	USB OTG, Console Port, MicroSD
②	LAN, USB (M12 Type)	⑤	1 Watt Speaker
③	RS232 (M12 Type)		

R15FA3S-GSC3(HB)

Unit: mm
Dimensions: 363.4 x 277.86 x 45.2

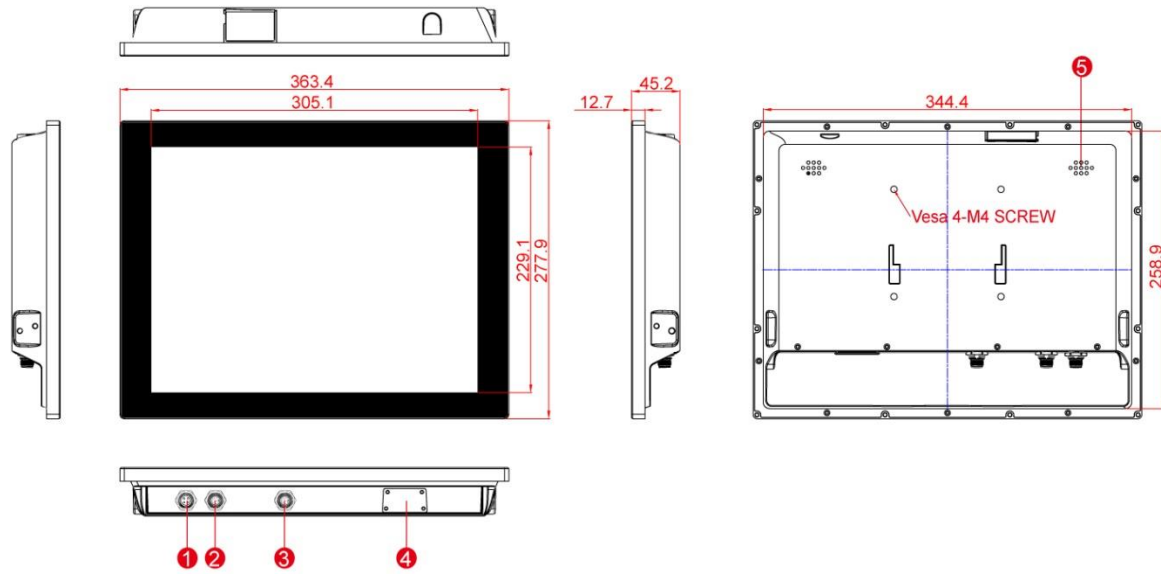

No	Description	No	Description
①	12V DC (M12 Type)	④	USB OTG, Console Port, MicroSD
②	LAN, USB (M12 Type)	⑤	1 Watt Speaker
③	RS232 (M12 Type)		

GETTING STARTED

This chapter tells you important information on power supply, adapter and precautions tips. Pay attention to power considerations.



CHAPTER 2: GETTING STARTED

This chapter provides information on how to connect the HMI device to the source of power, connector pinouts and the guideline to turn on/off the HMI device.

2.1 Turning on and off Your Device

To turn on the device:

1. Remove the protective cap of the power connector.

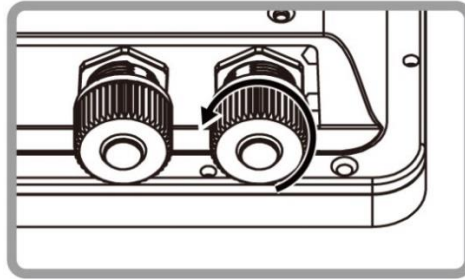

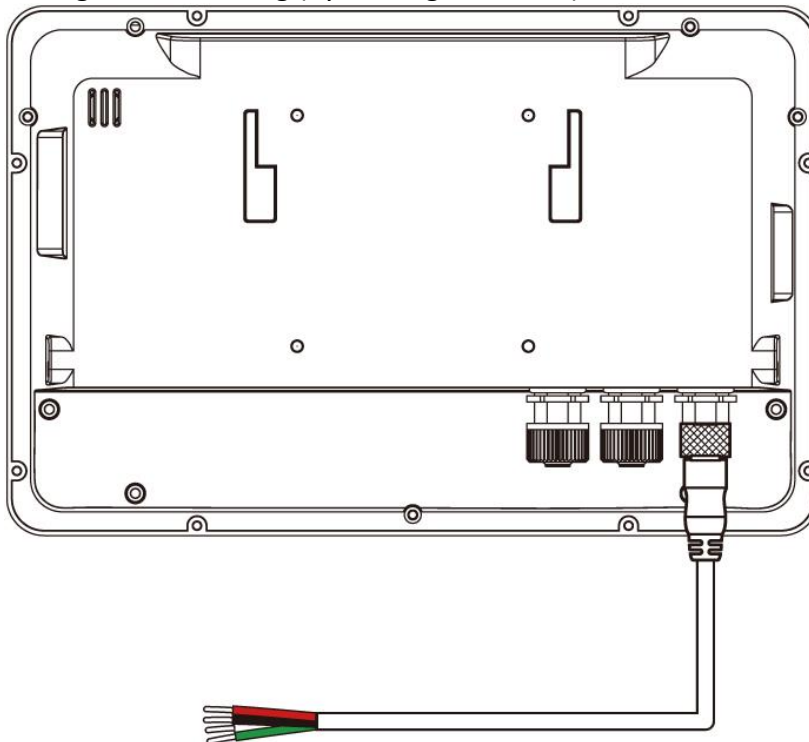

2. Connect power cable to the connector of your device. Make sure the cable fits to the connector, then tighten the O-ring (by turning clockwise) to secure the connection.



3. The device will boot automatically when powered on.

To turn off the device:

1. Swipe down from the top right of the screen.
2. Touch the **POWER OFF**  item.
3. Again touch **POWER OFF**  item.

Disconnect the power cord from the HMI device to completely power off the device.

2.2 Connecting to Other Devices

2.2.1 Diagram

The Panel PC features M12 type connectors with protective cap and has full IP65 rating. This Panel PC comes with various interfaces located on the bottom panel. All of these connectors have been shipped with protective caps. To ensure the waterproof function can work properly, make sure that the protective caps and have been securely tightened whenever the connectors are not used.

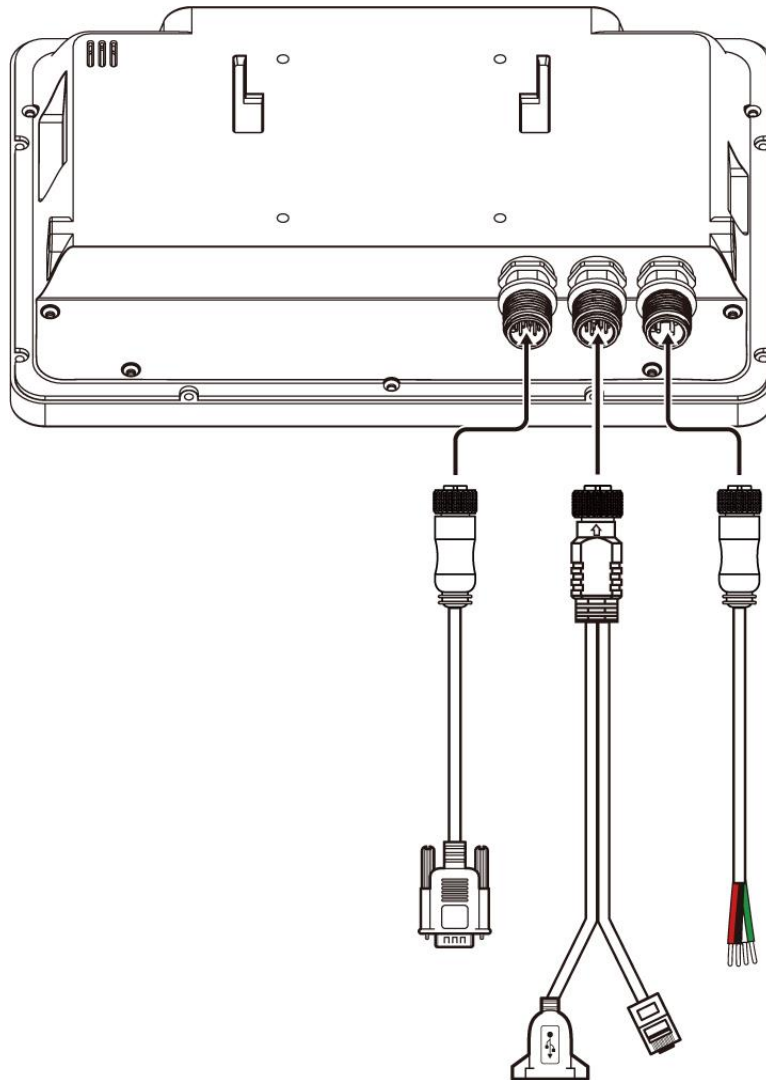

IMPORTANT

Please note that when reinstalling the protective cap, it must be fully tightened to ensure the unit is properly sealed to meet the IP65 enclosure rating.

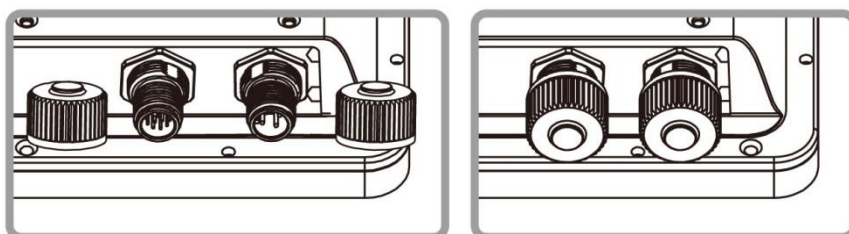

2.2.2 Connector Description

2.2.2.1 Power Input Connector

Panel PC has M12 type 4 pin male power input connector which accepts DC power input. Use IP65 power cable to connect the Panel PC to the source of power.

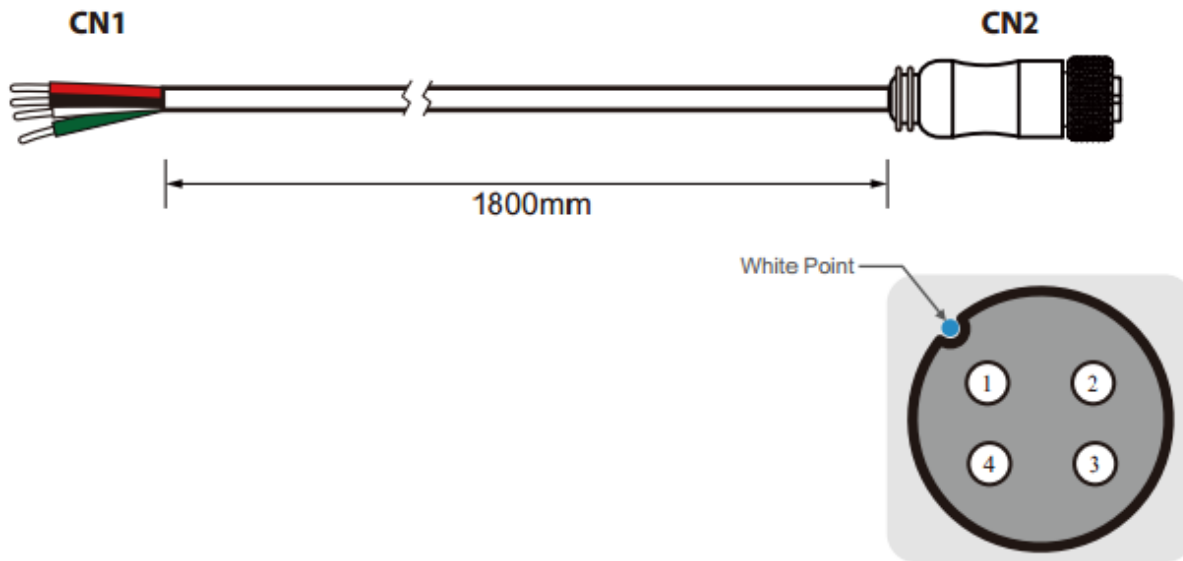

Pin No.	Symbols	Color
CN1-1	VIN+	Red
CN1-2	VIN-	Black
CN1-3	VIN-	White
CN1-4	NC	Green

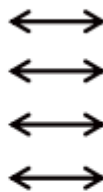

Pin No.	Symbols	Color
CN2-1	VIN+	Red
CN2-2	VIN-	Black
CN2-3	VIN-	White
CN2-4	NC	Green

2.2.2.2 Serial Interface Connector

Panel PC has M12 type 10 pin male RS-232 connector. Use IP65 serial cable to connect the Panel PC to external devices.

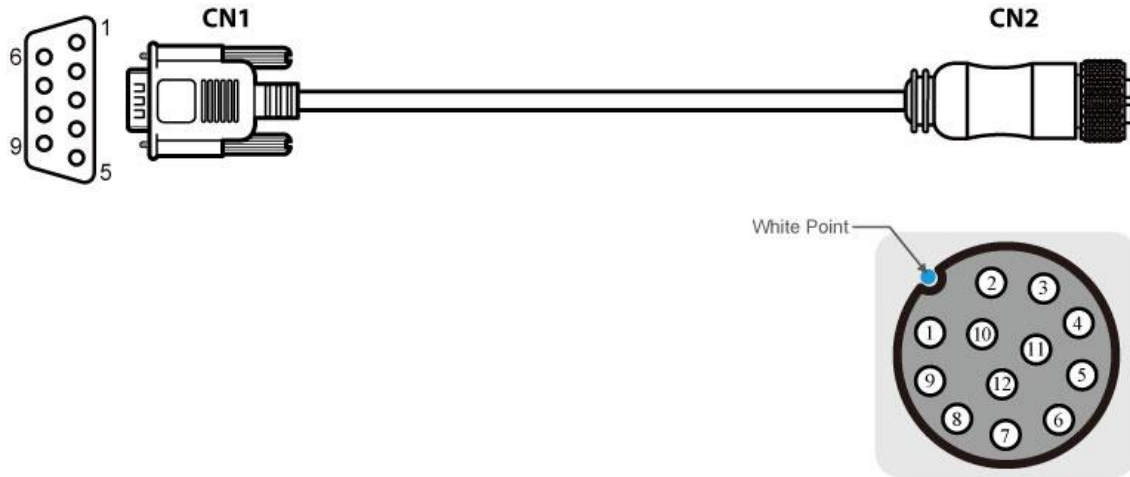

Pin No.	Symbols	Color		Pin No.	Symbols	Color
CN1-1	DCD-CON2	Green	↔	CN2-1	DCD-CON2	Green
CN1-6	DSR-CON2	Brown	↔	CN2-2	DSR-CON2	Brown
CN1-2	RXD-CON2	Red	↔	CN2-3	RXD-CON2	Red
CN1-7	RTS-CON2	Orange	↔	CN2-4	RTS-CON2	Orange
CN1-3	TXD-CON2	Blue	↔	CN2-5	TXD-CON2	Blue
CN1-8	CTS-CON2	White	↔	CN2-6	CTS-CON2	White
CN1-4	DTR-CON2	Purple	↔	CN2-7	DTR-CON2	Purple
CN1-9	RI-CON2	Yellow	↔	CN2-8	RI-CON2	Yellow
CN1-5	GND-CON2	Black	↔	CN2-9	GND-CON2	Black

2.2.2.3 Giga LAN + USB 2.0 Connector

Panel PC has M12 type 12 pin male Giga LAN and USB connector that supports two LAN and one USB 2.0.

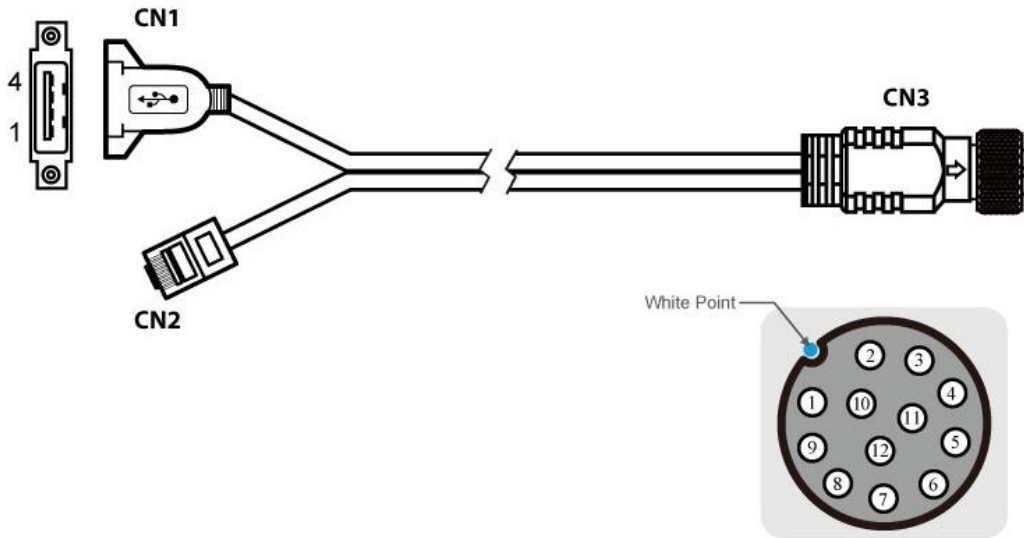

Pin No.	Symbols	Color
CN3-1	VCC	RED
CN3-2	D-	WHITE
CN3-3	D+	GREEN
CN3-4	GND	BLACK
CN3-5	White/Orange	
CN3-6	Orange	
CN3-7	White/Green	
CN3-8	Blue	
CN3-9	White/Blue	
CN3-10	Green	
CN3-11	White/Brown	
CN3-12	Brown	

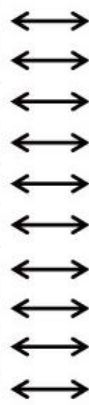

Pin No.	Symbols	Color
CN1-1	VCC	RED
CN1-2	D-	WHITE
CN1-3	D+	GREEN
CN1-4	GND	BLACK
CN2-1	White/Orange	
CN2-2	Orange	
CN2-3	White/Green	
CN2-4	Blue	
CN2-5	White/Blue	
CN2-6	Green	
CN2-7	White/Brown	
CN2-8	Brown	

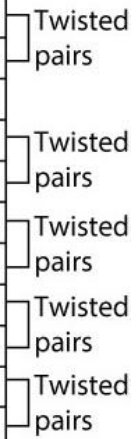

2.2.2.4 USB OTG Connector

Panel PC has USB OTG connector located either on the rear side or on the bottom. Use USB OTG connector to connect the HMI device to other USB On-The-Go compliant devices such as flash drives, digital cameras, mice or keyboards. Use USB OTG cable to install software on the HMI device. USB OTG connector is located under the protection cover. Please undo four screws to access the connector.

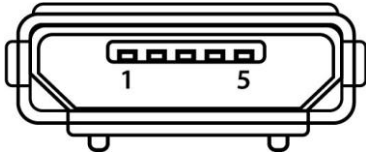

Pin №	Signal Name	Pin №	Signal Name
1	+5V	2	USB_OTG_D-
3	USB_OTG_D+	4	USB_OTG_ID
5	GND		

2.2.2.5 MicroSD Card

MicroSD card slot is located under the protection cover. Please undo four screws to access the slot. Insert microSD card to microSD card slot to extend the memory of your Panel PC.

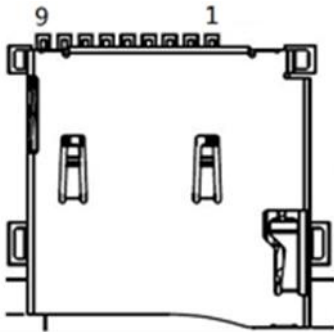

Pin №	Signal Name	Pin №	Signal Name
1	DATA2	2	DATA3
3	CMD	4	+3.3V
5	CLK	6	GND
7	DATA0	8	DATA1
9	Card_Det		

2.3 Configuring Serial COM Port Settings

port settings application for Android OS.

To configure serial port settings:

1. Settings  > Accessibility.

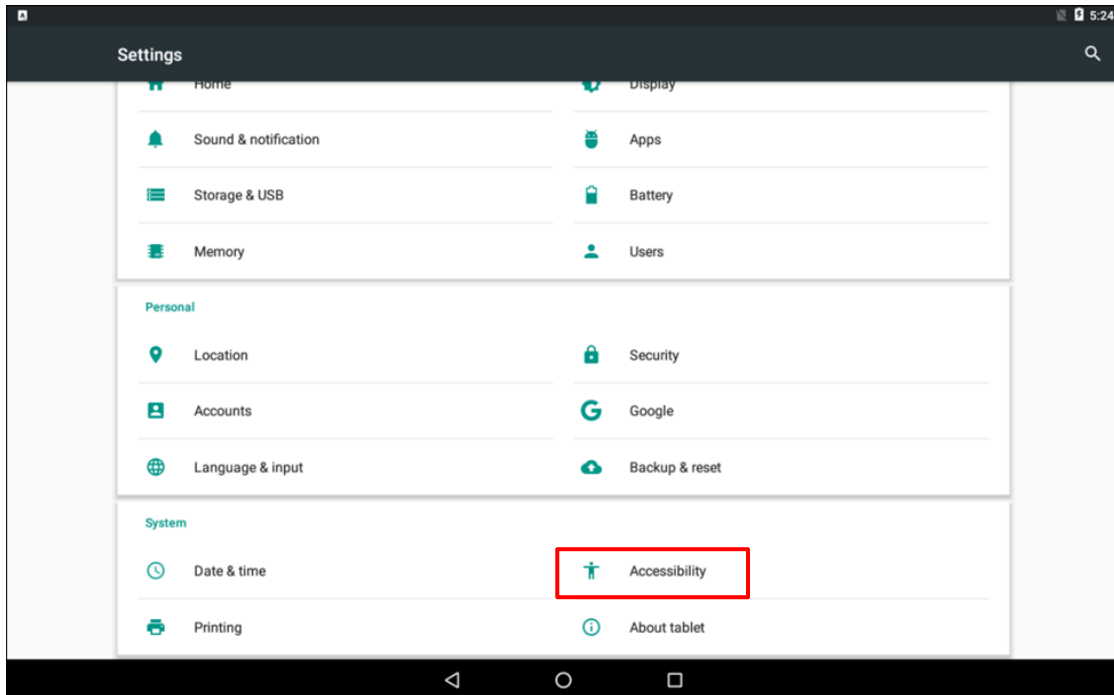

2. Accessibility > System: Comport-Setting.

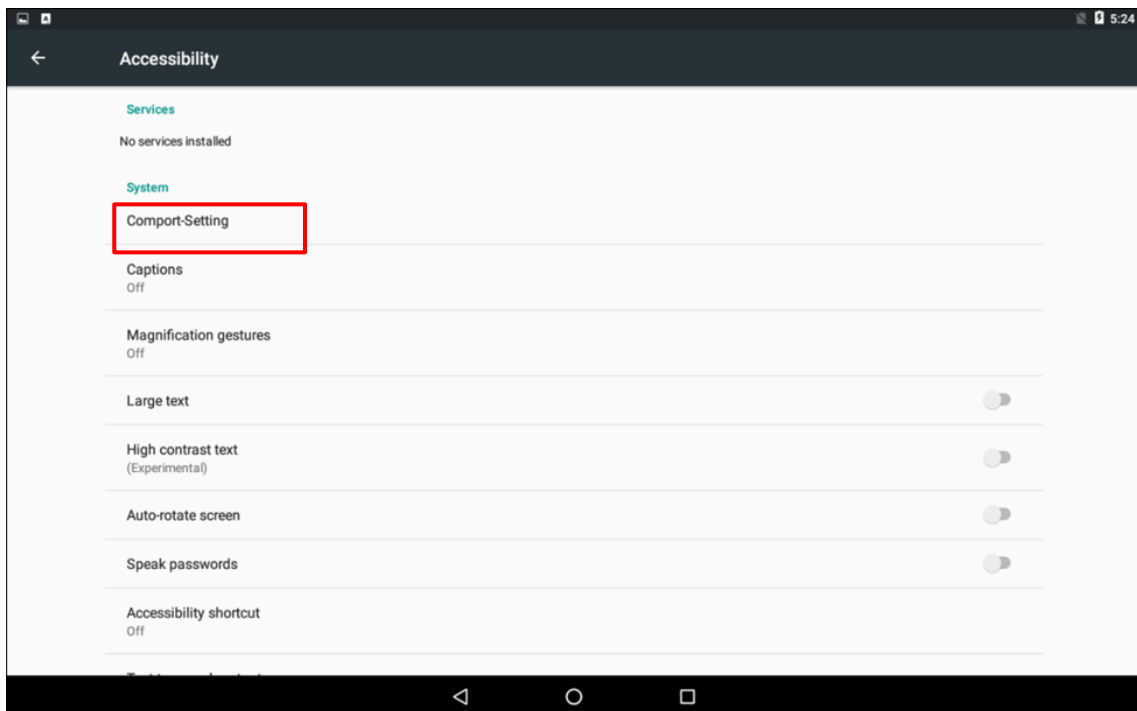

3. Comport-Setting > Comport 1/ Comport 2/ Comport 3

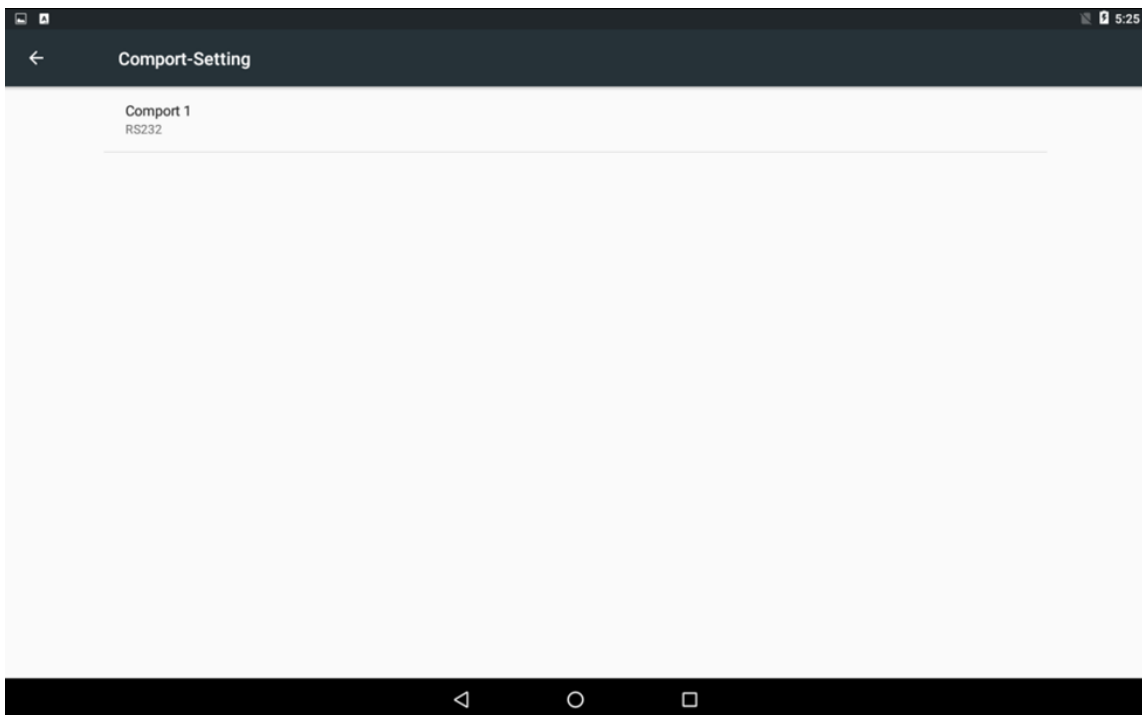

** Select Comport 1/ Comport 2/ Comport 3 that you want to configure.*

4. Comport 1 > RS232/RS422/RS485

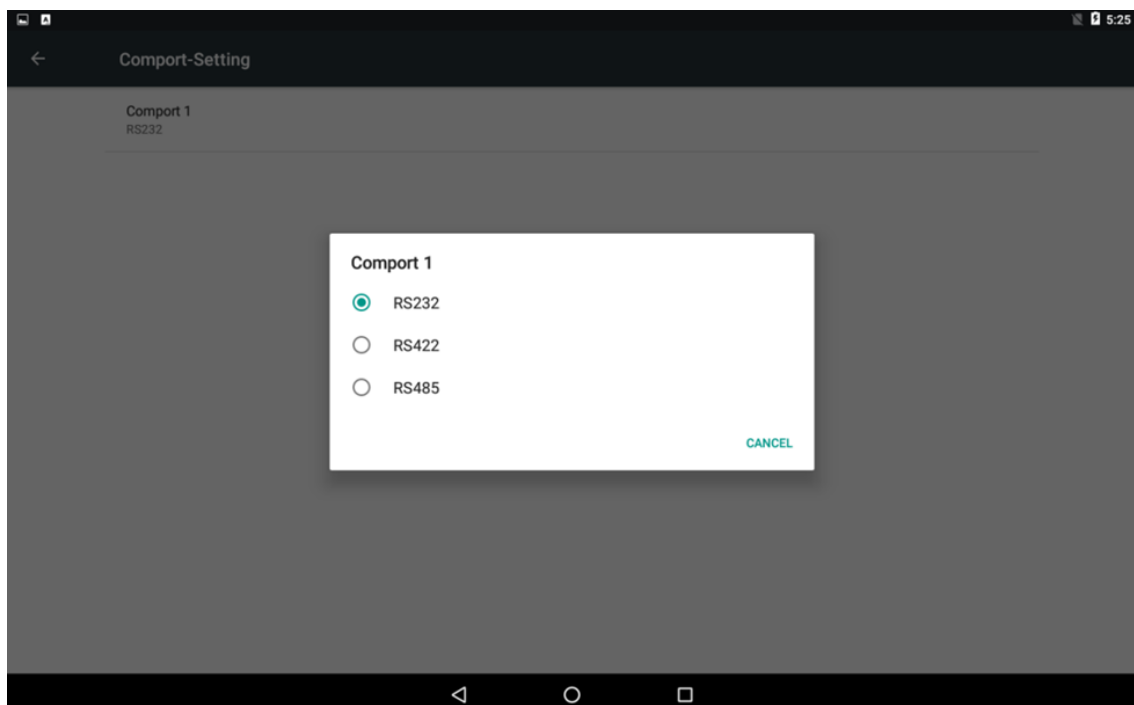

** Configure Comport 1 settings*

OPERATING THE DEVICE

This chapter provides detailed information on how to operate the device. If you have been using Android touch-screen Panel PCs before, the interface may look familiar. Sections include system settings parameters.



CHAPTER 3: OPERATING THE DEVICE

In this chapter you will find an instruction on how to operate the HMI device.

3.1 Operating System

G-WIN Slim IP65 Panel PC (P-CAP) supports:

- Android 6.0 (Default)
- Linux Kernel 4.1.5, QT 5.5 Browser (Optional)
- Ubuntu 16.04 (Optional)



IMPORTANT:

The device is shipped with the OS System according to your order. Contact us if you have any questions regarding OS settings.









IMPORTANT:

The watchdog timer is set by default. The system will automatically reboot if it hangs after 30 seconds. If the app hangs, watchdog function will not be activated.

3.2 Multi-Touch

The touchpad supports the core gestures for Android.

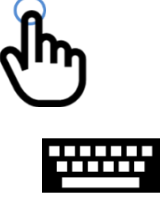
Gesture	Action	Description
Touch		To select or activate something
Touch & Hold		Touch and hold an item on the screen by touching it and not lifting your finger until it respond
Touch, Hold & Drag		Touch and hold an item for a moment and then without lifting your finger, move your finger on the screen until you reach the target position. i.e. moving the apps around the home screen
Swipe or slide		Quickly move the finger across the surface of the screen. i.e. slide a lock screen to open the lock
Double-tap		Tap quickly twice on a webpage, screen, or App to zoom
Scale		Place two finger on the screen and pinching them together
Type		Touch where you want to type. A keyboard pops up that lets you type into the field.

**Reference from Android*

3.3.1 Setting up the Device

When you first turn on your HMI device, you'll see a **Welcome screen**. Choose the language you want and touch **Start** or the Start icon. When prompted, you can sign in with your Google Account or create one at that time. You can also choose to skip this step and create one later.

3.3.2 Home Screen

Your device runs on Android 6.0 Operation System (Default).

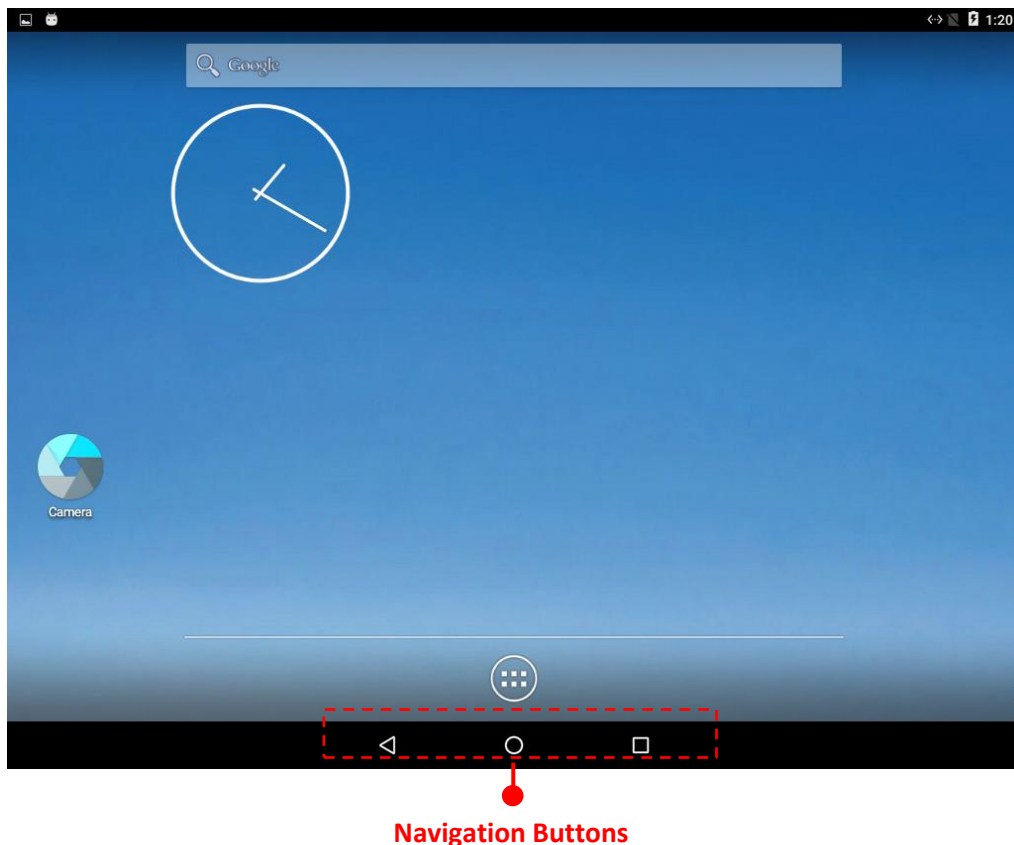

**Back**

Opens the previous screen you were working in, even if it was in a different app. Once you back up to the Home screen, you can't go back any further.

**Home**

Returns to the Home screen. To get suggestions based on the screen you're currently viewing, touch & hold this button.

**Overview**

Opens a list of thumbnail images of screens you've worked with recently. To open one, touch it. To remove a screen from the list, swipe it left or right or touch the X.

Your apps

To see all your apps, touch  in the Favorites tray on any Home screen. This is where you can see all your apps, including those that come with your phone or tablet and those you downloaded on Google Play. You can move app icons to any of your Home screens. The apps you've used most recently appear in the first row.

Some apps hide these buttons temporarily, or fade them to small dots in the same position. To bring them back, touch the dots, touch the screen in the middle, or swipe up from the bottom.

Many screens in apps and Settings include a **menu**  icon at the top right of the screen. Touch it to explore additional options, including Help & feedback.

To add an app to a Home screen:

1. Go to the Home screen where you want to place the app.
2. Touch **All Apps** .
3. Swipe from left to right to find the app you want.
4. Touch & hold the app until the Home screen appears, slide it into place, and lift your finger.





To remove an app icon from the Home screen without removing it permanently from your device, touch & hold it, slide your finger toward the top of the screen, and drop the app over Remove in the top left.

3.3.3 Quick Settings

You can open your device's Settings app from the All Apps screen or from Quick Settings.

For example, to change notification sounds, and volume go to Settings  > Device > Sound to change the volume.

Use Quick Settings to easily change frequently used settings, like turning on Wi-Fi. To open Quick Settings, swipe down from the top of the screen with two fingers. To change a setting, just touch the icon:

- **Display brightness:** Slide  to lower or increase the brightness of your screen.
- **Wi-Fi network:** Turn Wi-Fi  on or off or open the Wi-Fi settings menu.
- **Bluetooth settings:** Turn Bluetooth  on or off or open the Bluetooth settings menu.
- **Auto-rotate:** Lock your device's orientation  in portrait or landscape mode.

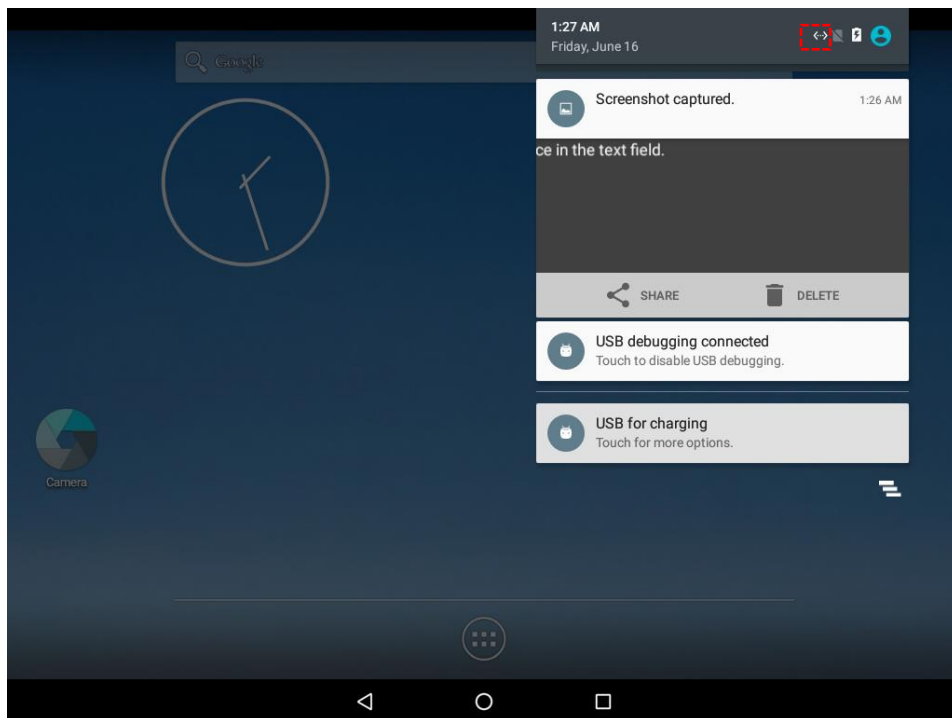

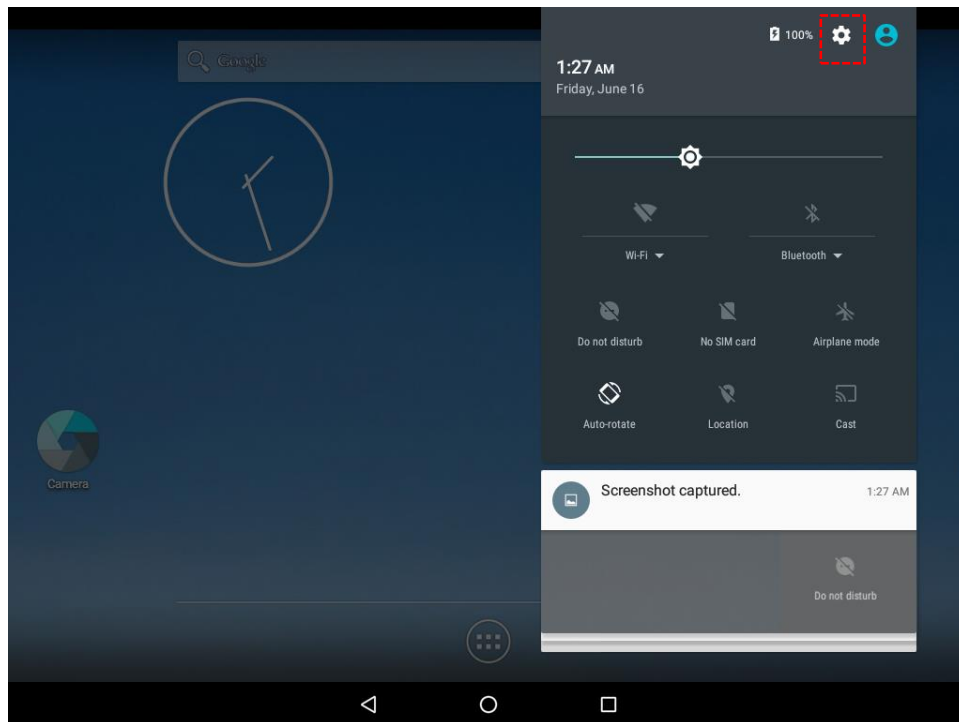

Open the main Settings menu by touching **Settings**  at the top right.

3.4 Ethernet

1. Connect Ethernet Cable to the HMI.
2. Touch **All APPS** icon, and the open **Ethernet** application.

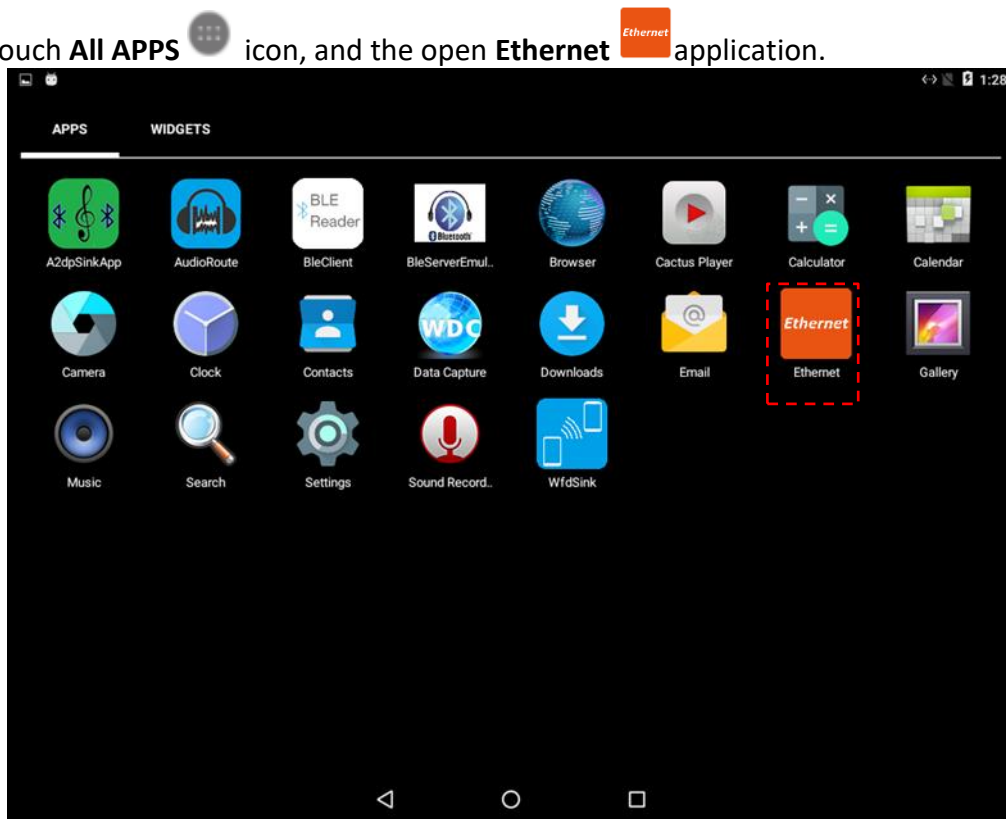

3. Ethernet APP main menu appears

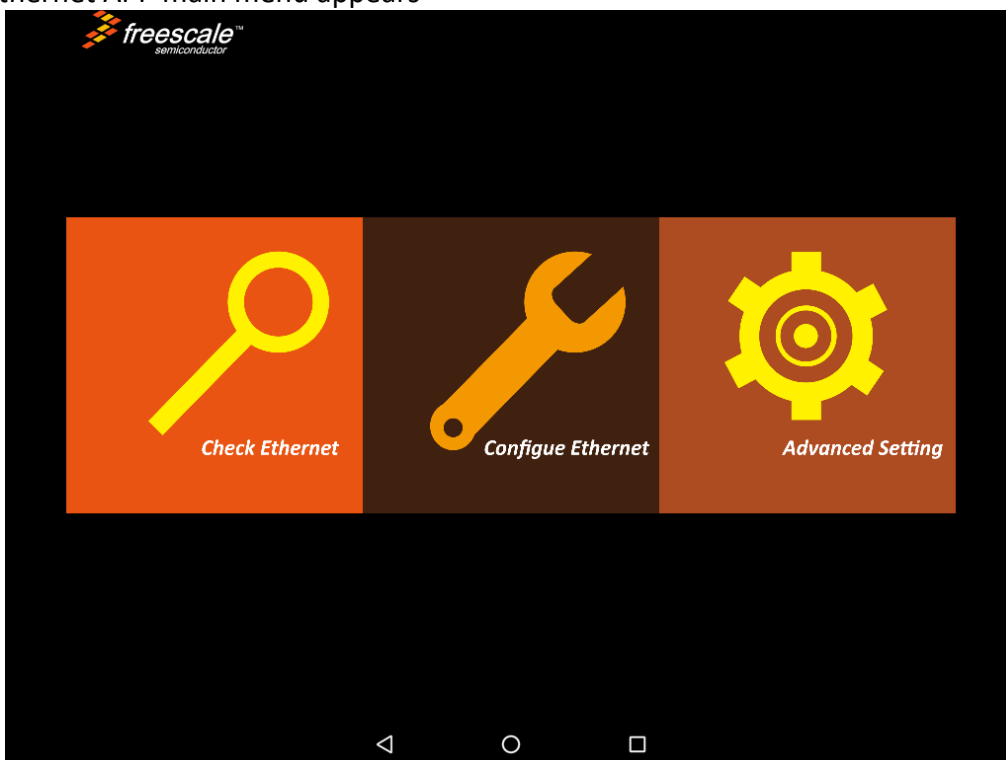

3.4.1 Configuring Ethernet Settings

Go to All Apps  > Ethernet  > Configure Ethernet

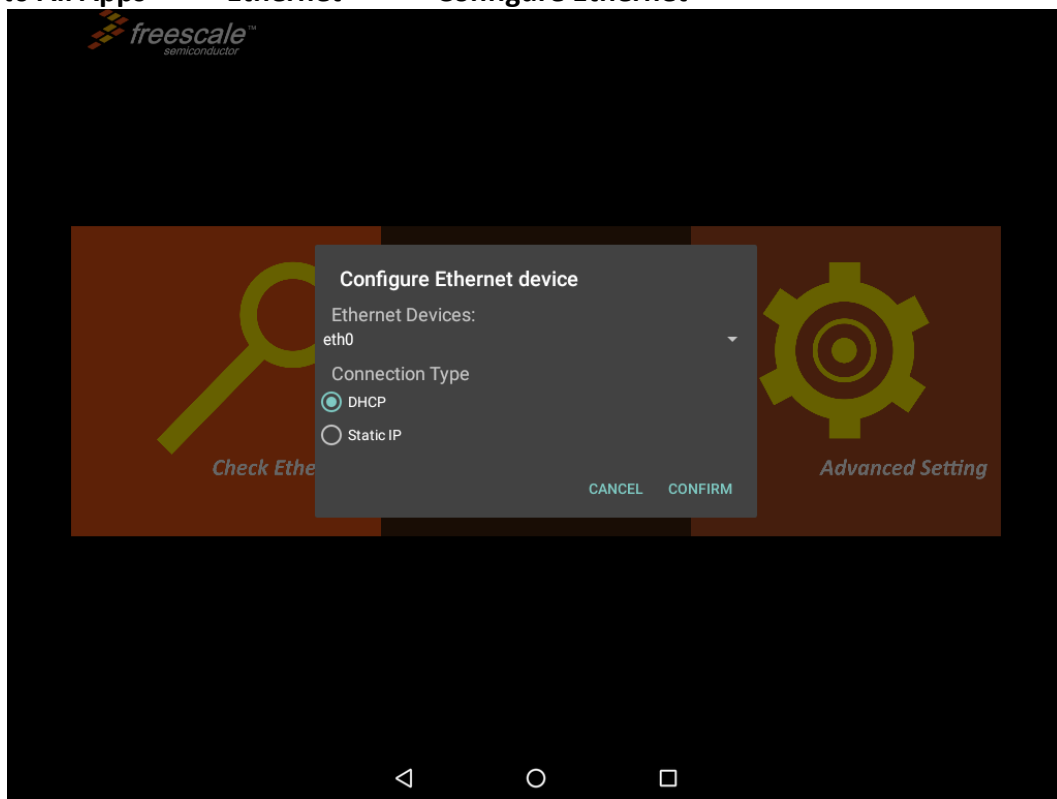

Ethernet OFF is set by default. Swipe **Ethernet ON to activate Ethernet connection.*

Connection Type

Setting	Description
DHCP	The device automatically capture IP-address from the router
Static IP	Allows to manually set up IP-address, DNS, Network and Gateway

3.4.2 Checking Ethernet Settings

To check Ethernet settings:

Go to **All Apps**  > **Ethernet**  > **Check Ethernet**

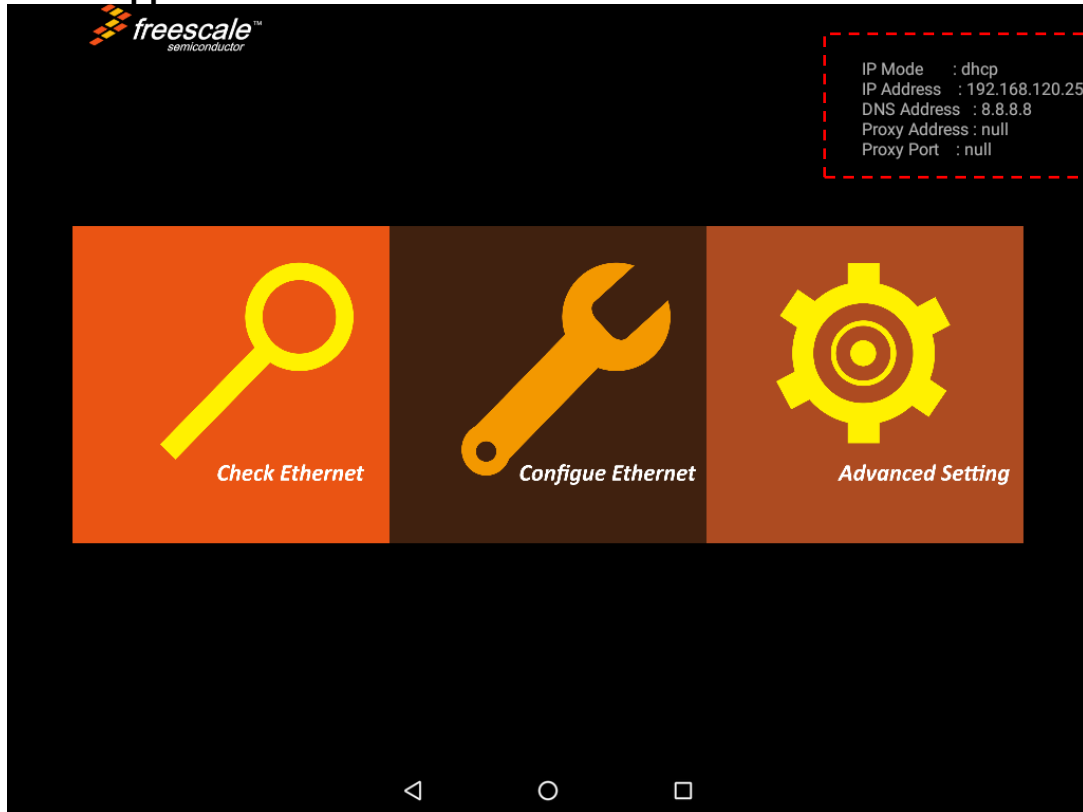

Ethernet settings menu appears on the top right side of the desktop.

3.5 Winmate® Home Manager (WHM)

Winmate® G-WIN Slim IP65 Panel PC (P-CAP) running on Android OS comes with preinstalled APP named Winmate Home Manager (WHM) which let the device manager to lock the launcher then the user can only use one application assigned by the device manager.

3.5.1 How to Lock Applications

To lock applications:

1. In the main APPS window, select the **Home Manager APP**  and tap it to open.

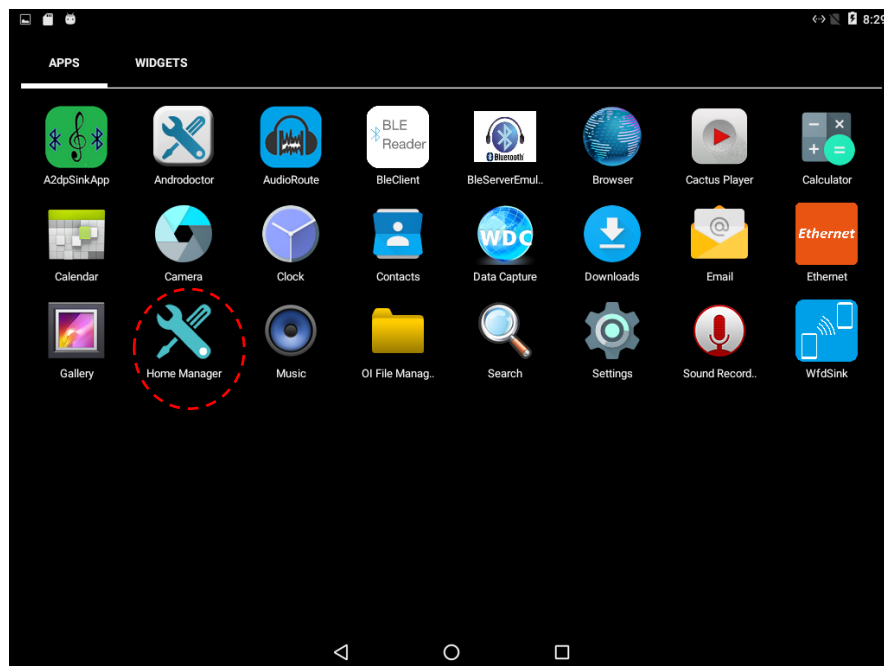

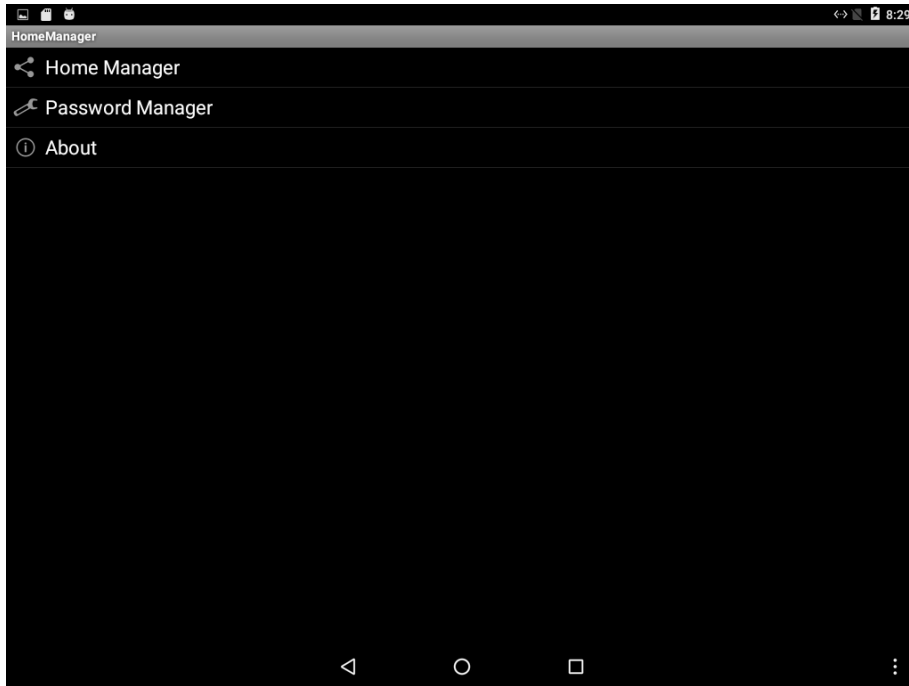

Menu	Description
Home Manager	Set which app you want to run up automatically after booting
Password Manager	Set the WHM password (Default password is "0000").
About	Displays information about Home Manager

2. Go to **"Application Selector"**, and choose the app which you want to run up automatically after booting.

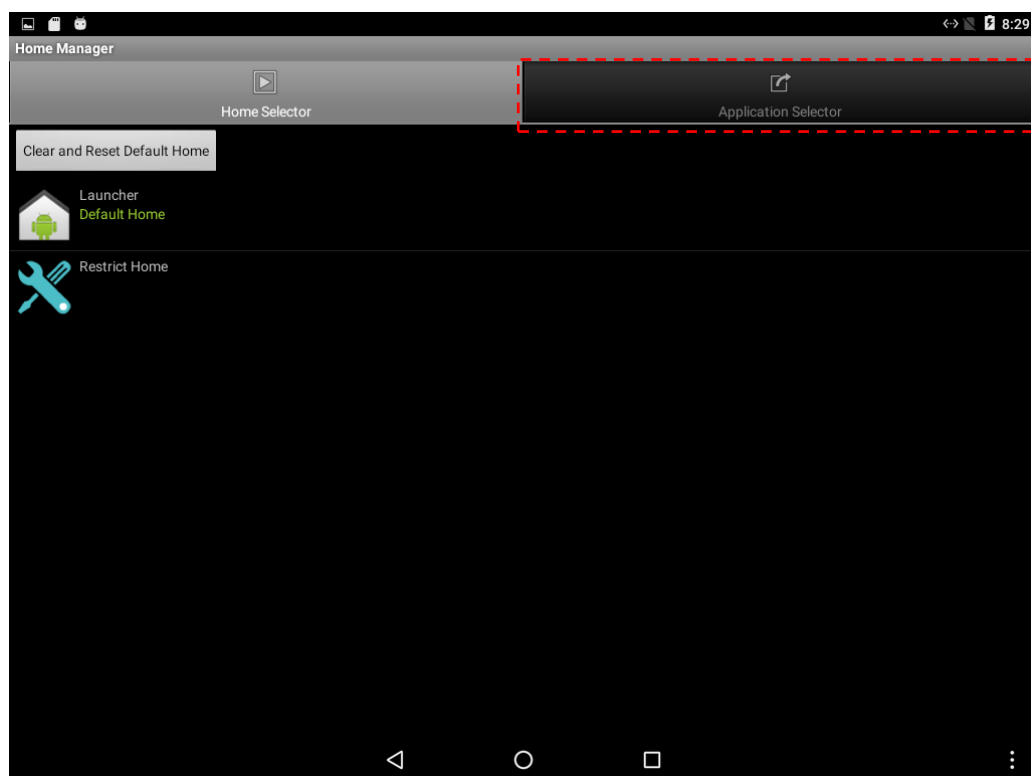

3. Go back to **“Home Selector”** and press **“Clear and Reset Default Home”**.

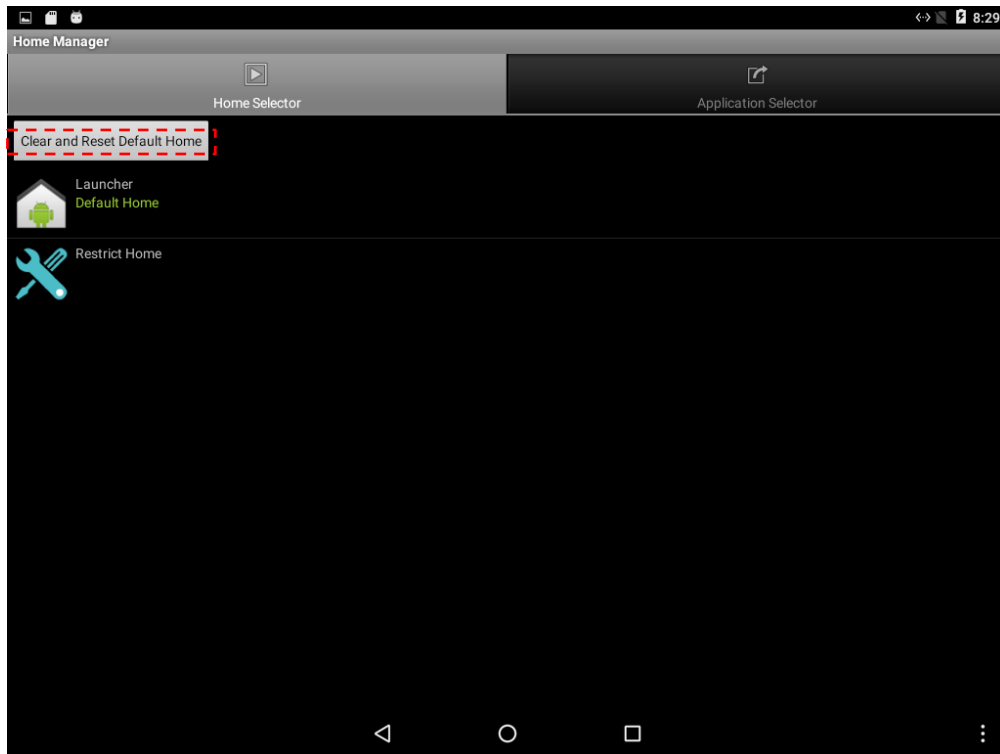

4. Select **“Restrict Home”** and **“Always”**, and then restart the computer to enable these settings.

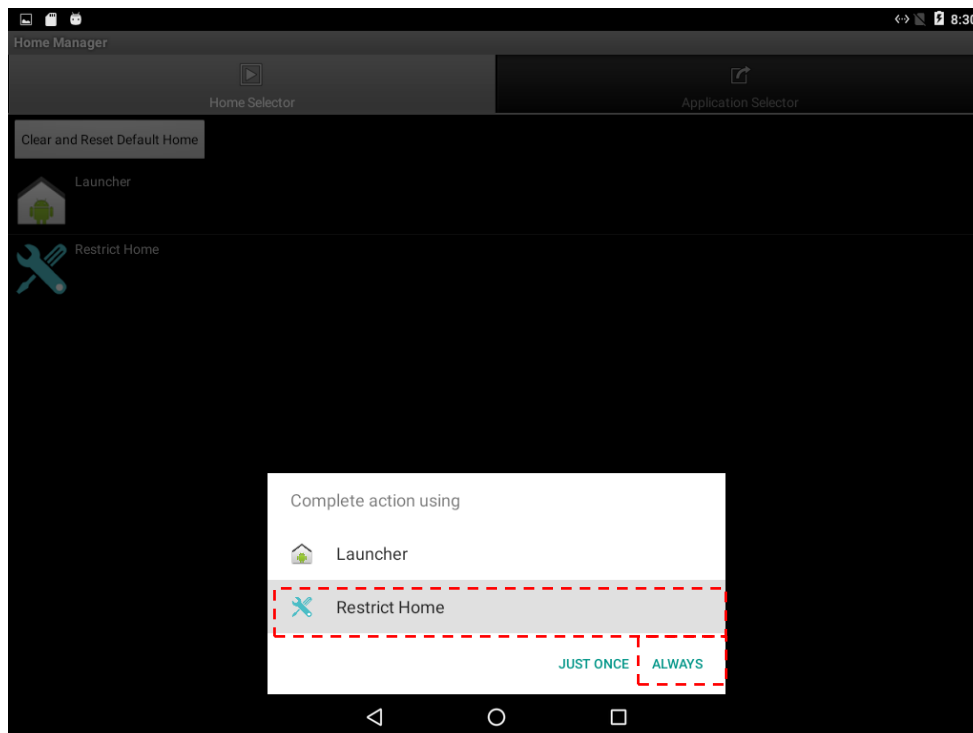

The system will automatically start the application which you selected and lock it. Any time user presses home key or back key; the system will go back to the same application which you have selected.

3.5.2 How to Unlock Applications

Follow the instruction below to reset Home Manager.

1. If you want to reset the home manager, pull down the left side to open the status bar and open **HomeManager**.

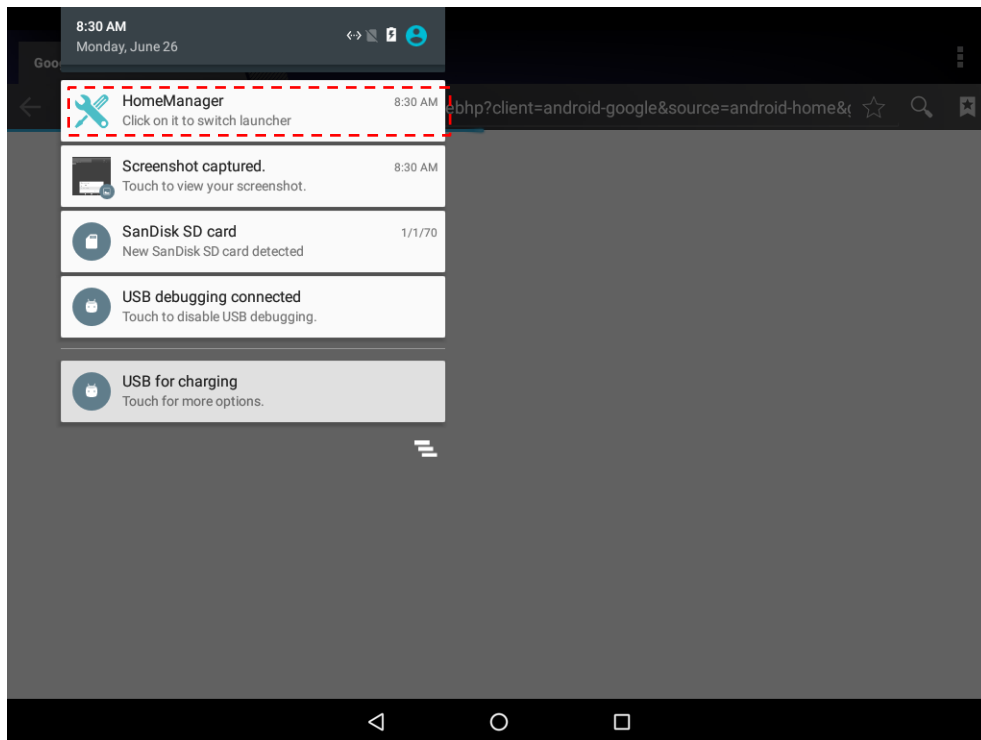

2. System will request the password to login. Touch **OK**.

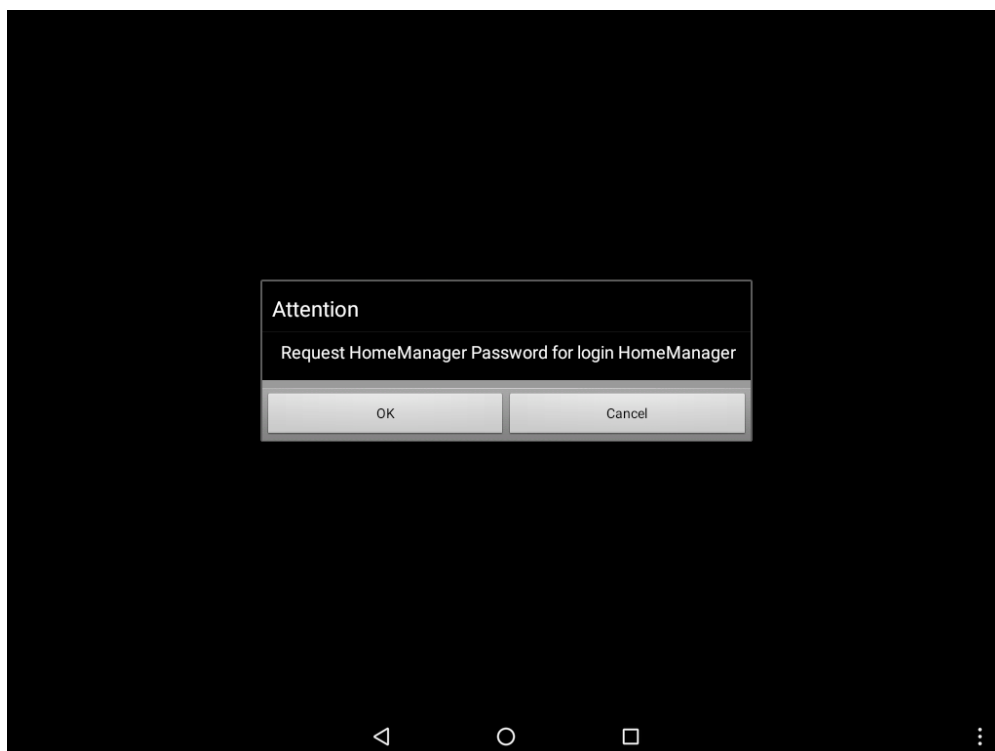

Default password is “0000”.

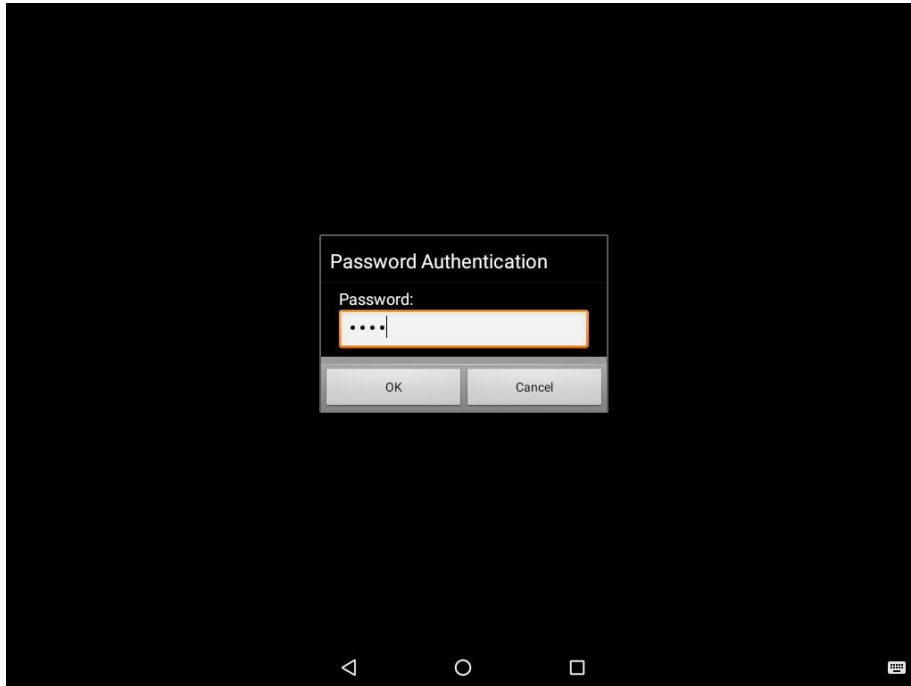

3. Restart the system and you will go back to the normal Launcher.

3.5.3 How to Change Password

To change the password:

1. Go to **Password Manager** and set your own password for this APP.
2. The **default password is “0000”**. Enter a new password in **New Password** field, and then tap **Change Password**.

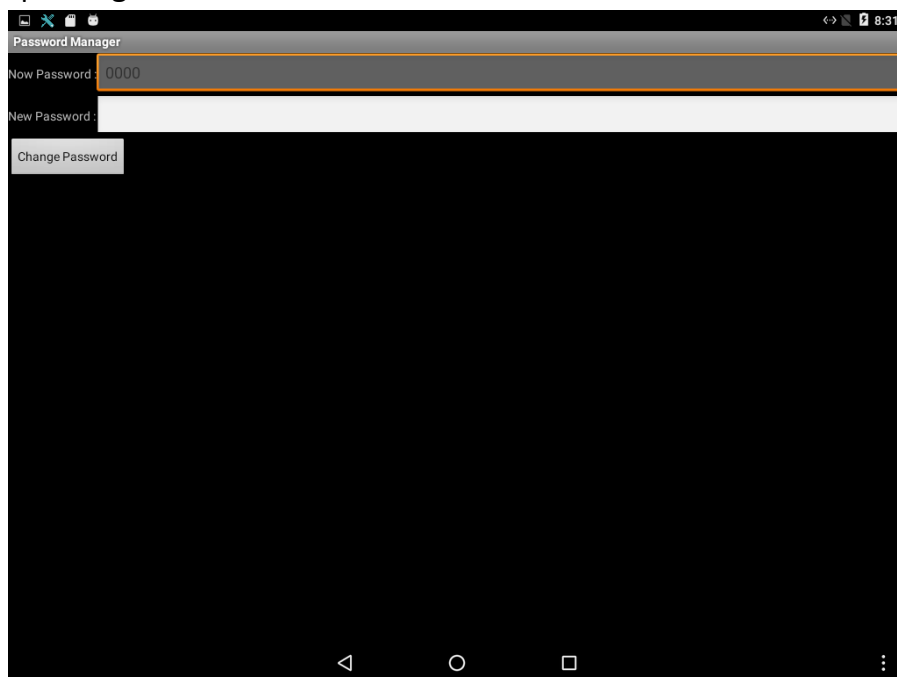

SOFTWARE INSTALLATION

This chapter contains software installation and update guides.



CHAPTER 4: SOFTWARE INSTALLATION

This chapter contains software installation and updates guide. All the programming guides can be found in the driver CD included in the package.

4.1 Android Debug Bridge (ADB) Driver Installation



IMPORTANT:

- If your computer is running on Windows Embedded 8 Standard or Windows 8.1 Industry Pro OS system, you need to disable driver signature.
- For Win XP / Win 7 skip disabling driver signature section, and directly proceed to [ADB driver installation](#).

You can find FA30-200_USB_OTG_driver in the following locations:

CDM v2.08.28 Certified\ftdibus.inf

CDM v2.08.28 Certified\ftdiport.inf

You need to connect HMI device to the computer with the USB 2.0 cable. When using a USB cable (not supplied with your HMI device), verify that the cable or cable packaging bears the “Certified USB™” mark (see below) to guarantee USB 2.0 compliance.

4.1.1 Disabling Driver Signature on Windows 8

Step 1 Hold down the Windows key on your keyboard and press the letter C to open the Charm menu, and then click the gear icon (**Settings**).



Step 2 Click **Change PC Settings**.

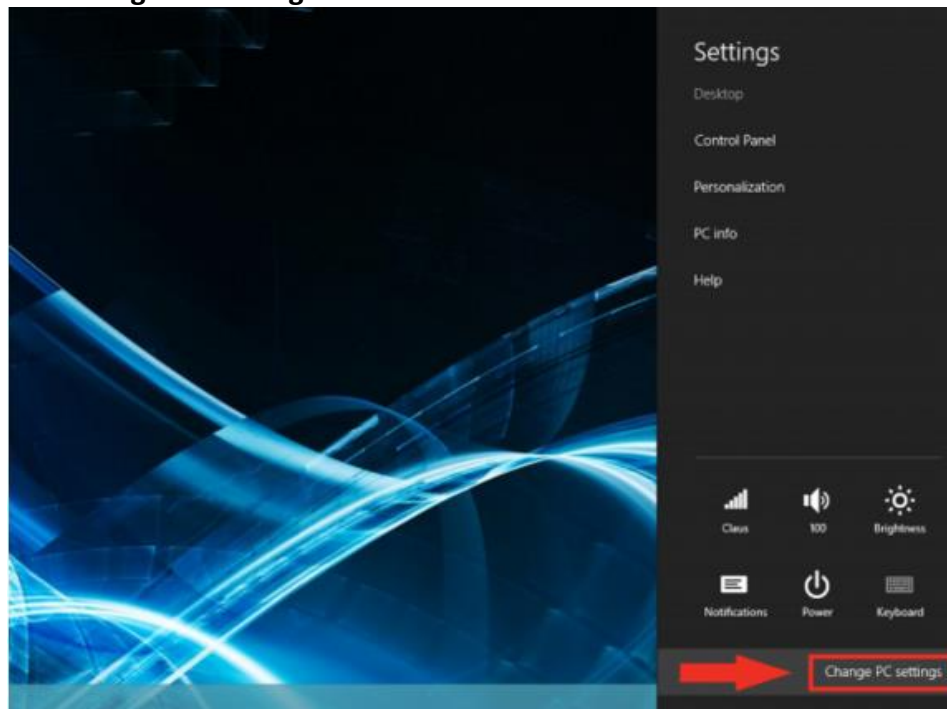

Step 3 Click **General**.

Step 4 Under **Advanced Startup**, click **Restart Now**.

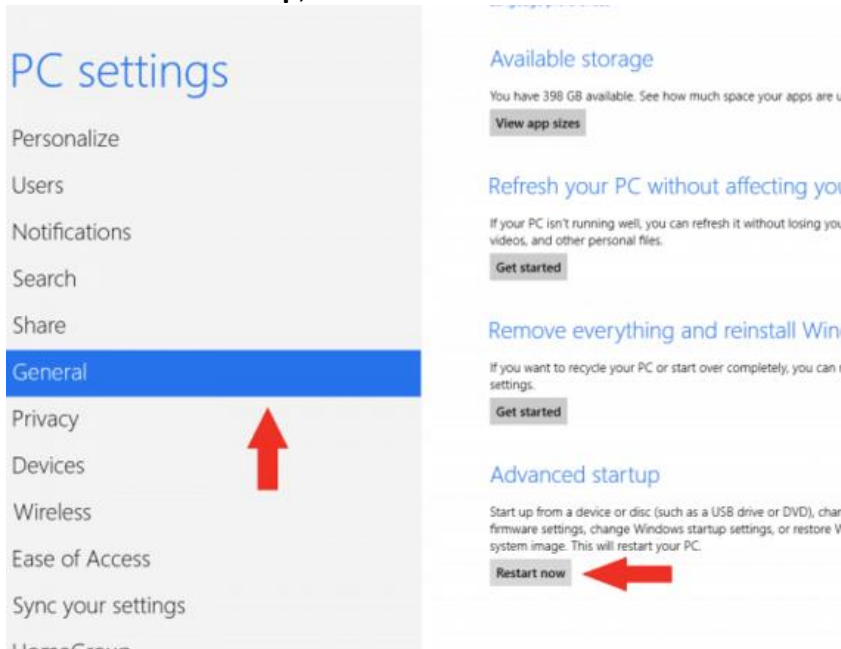

NOTE: In Windows 8.1, the 'Restart Now' button has moved to 'PC Setting -> Update & Recovery -> Recovery.'

Step 5 After restarting, click **Troubleshoot**.

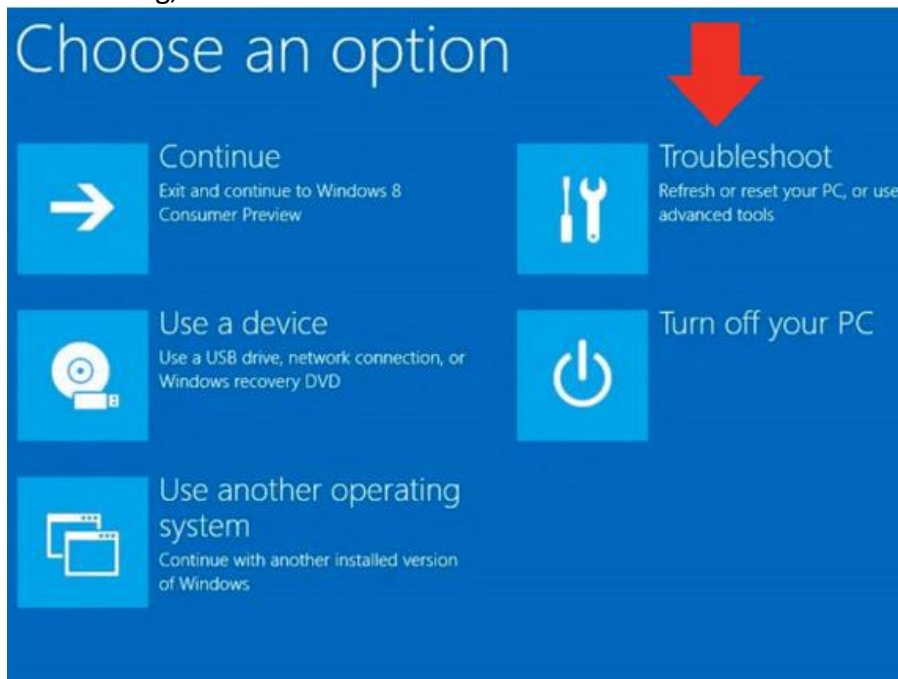

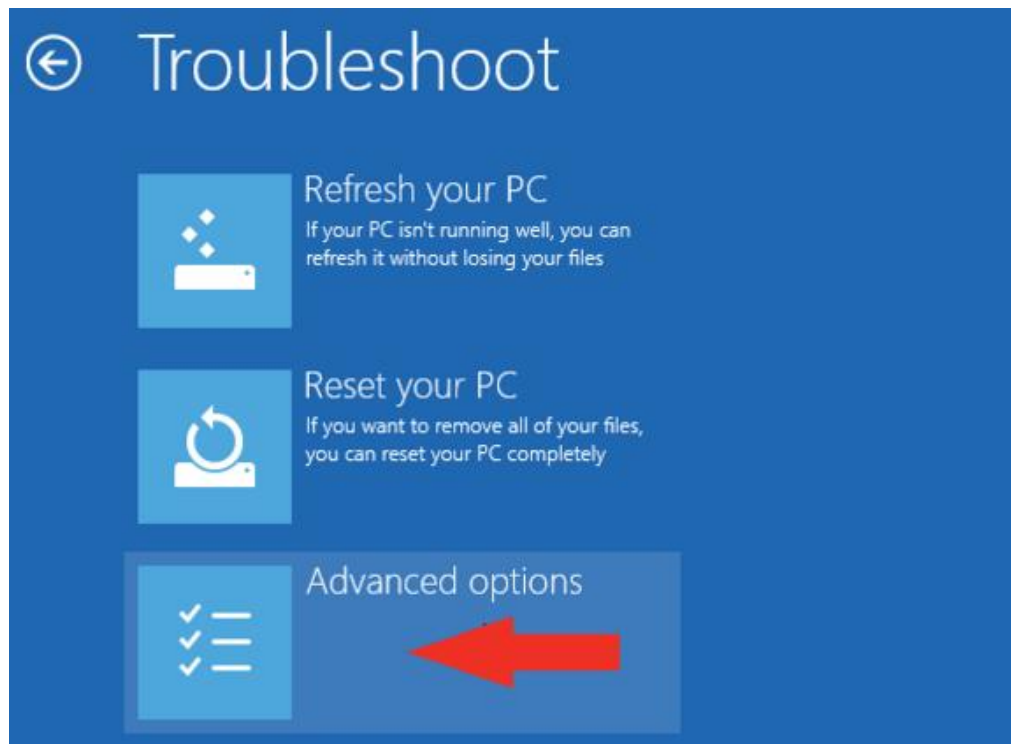
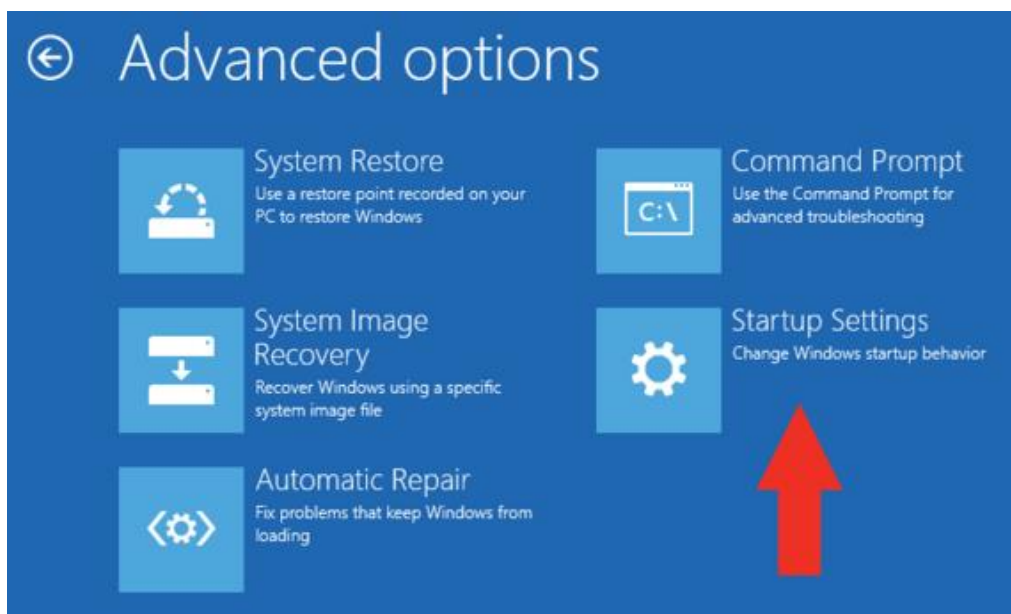
Step 6 Click Advanced Options.**Step 7 Click Windows Startup Settings.**

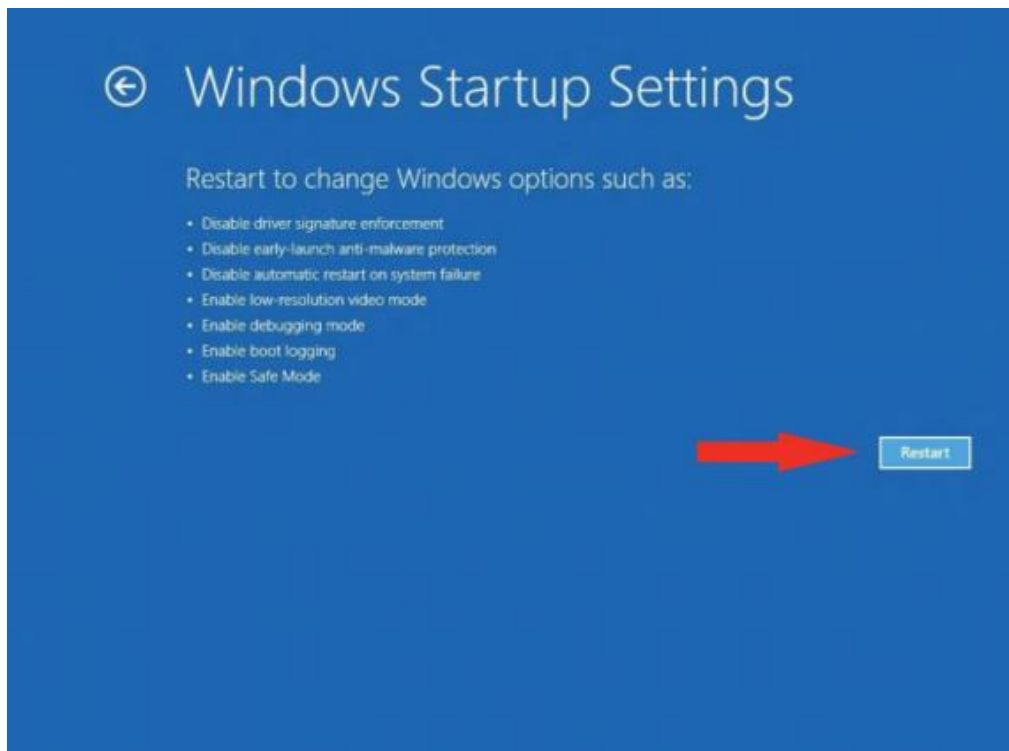
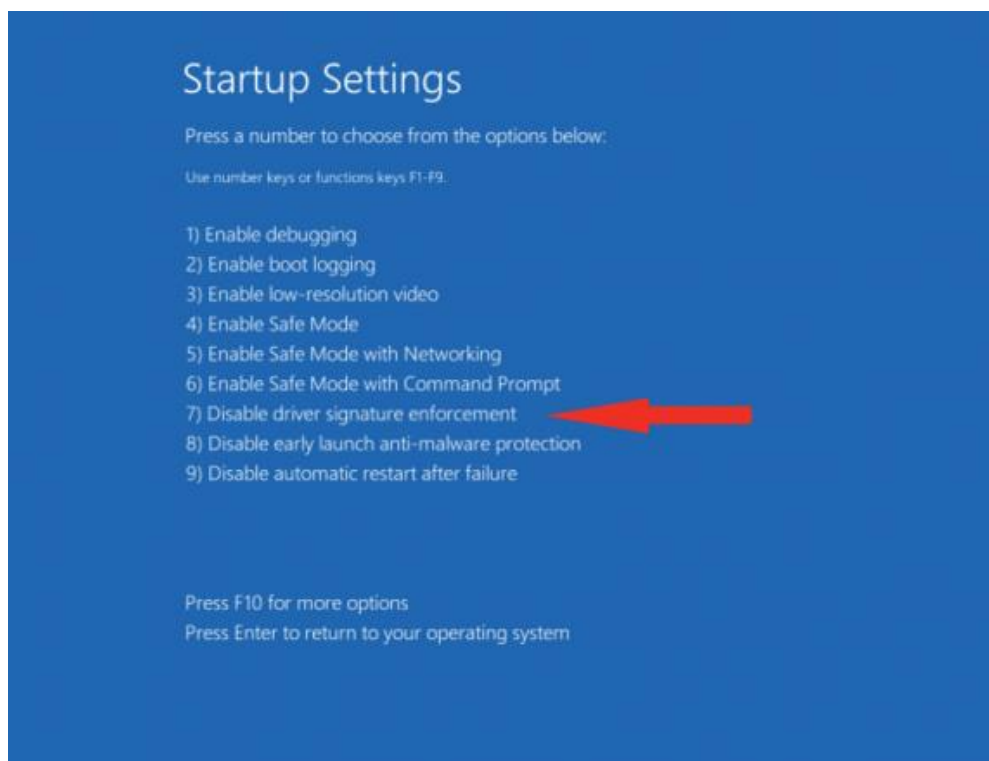
Step 8 Click **Restart**.**Step 9** After restarting your computer a second time, choose **Disable driver signature enforcement** from the list by typing the number 7 on your keyboard.

Your computer will restart automatically.

Step 10 After restarting, you will be able to install the ADB drivers normally; however, Windows will display a warning message. When the warning appears, click Install this driver software anyway. If you are unfamiliar with installing drivers, check out our Installing ADB driver tutorial for a step by step guide.

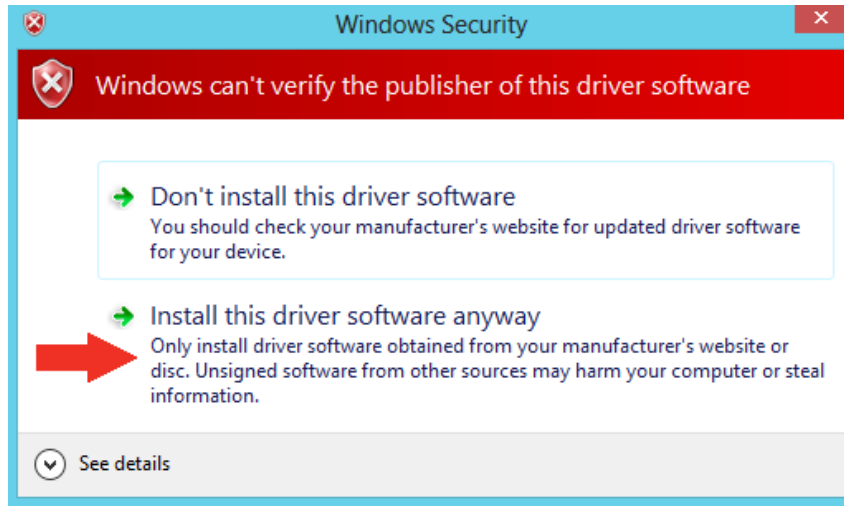

NOTE:

The next time you restart your computer, driver signature enforcement will be in effect again. You will have to repeat this process for any new boards. If you have multiple boards to use with the same computer, we recommend installing the drivers for each one before you shut down or restart your computer.

4.1.2 ADB Driver Installation

Step 1 Confirm whether the USB device was found by the system.

Device Manager > 120A > Other devices > FA33_Taurus > Update Driver Software

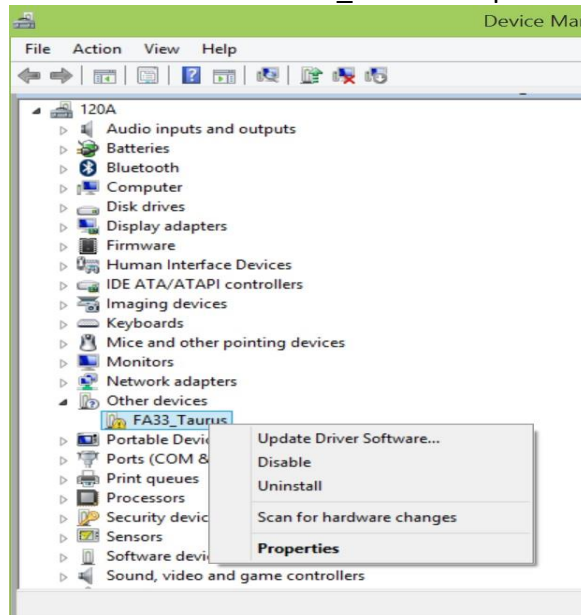

Step 2 In the Update Driver Software window choose **Browse my computer for driver software**.

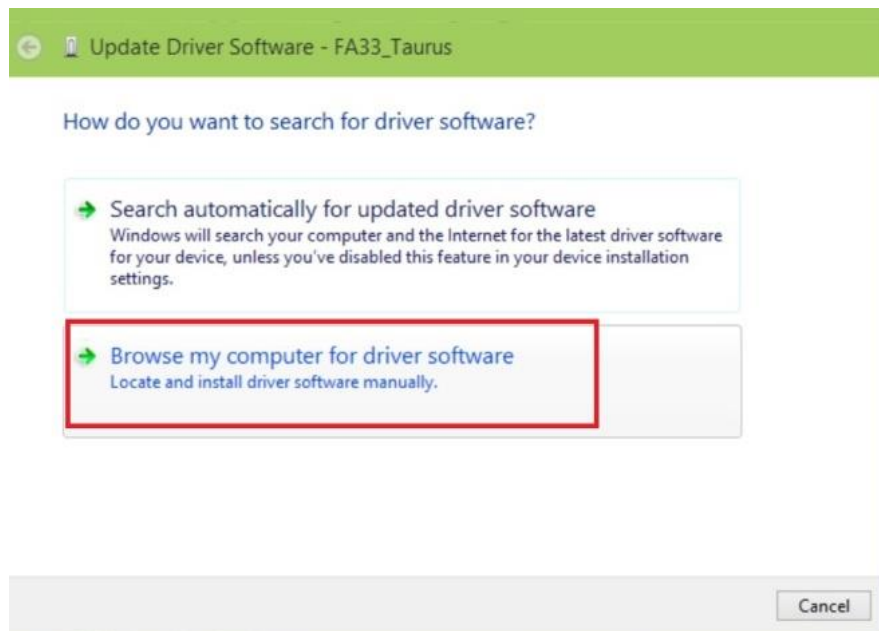

Step 3 Select **Let me pick from a list of device drivers on my computer**. Click **Next**.

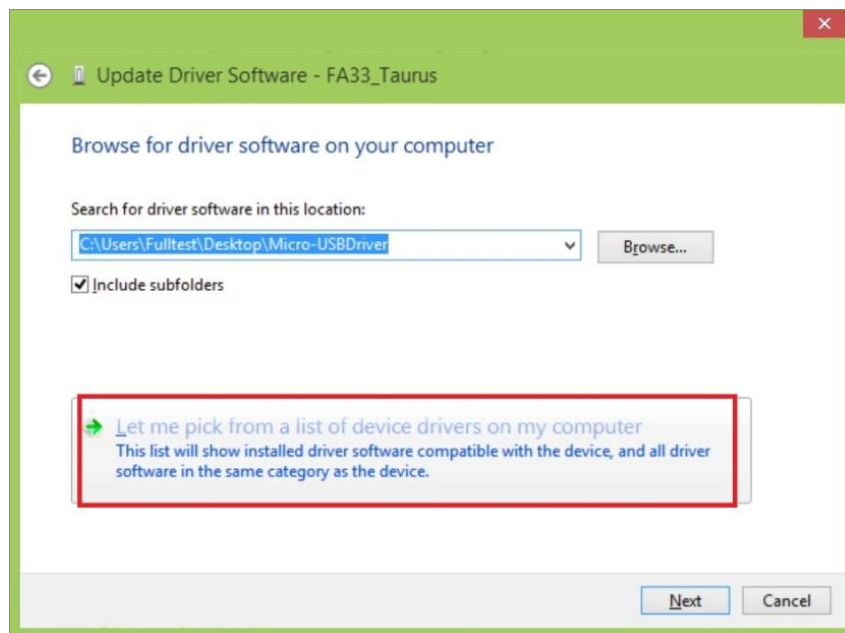

Step 4 Select from your computer

Step 5 In the Update driver software window, click show All Devices and then click **Next**.

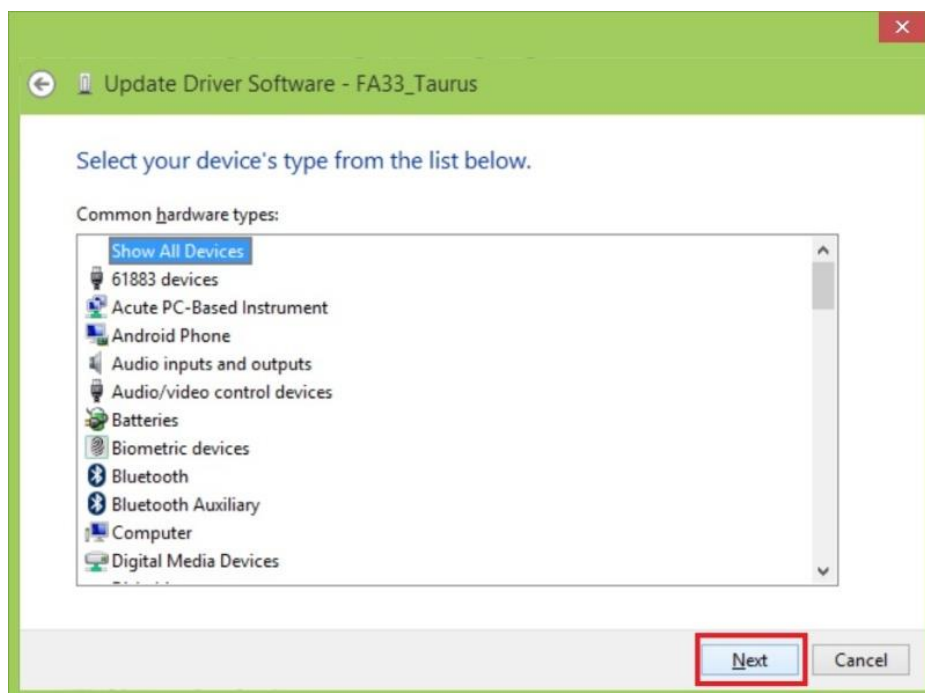

Step 6 The system is looking for the driver folder. Click **Browse**.

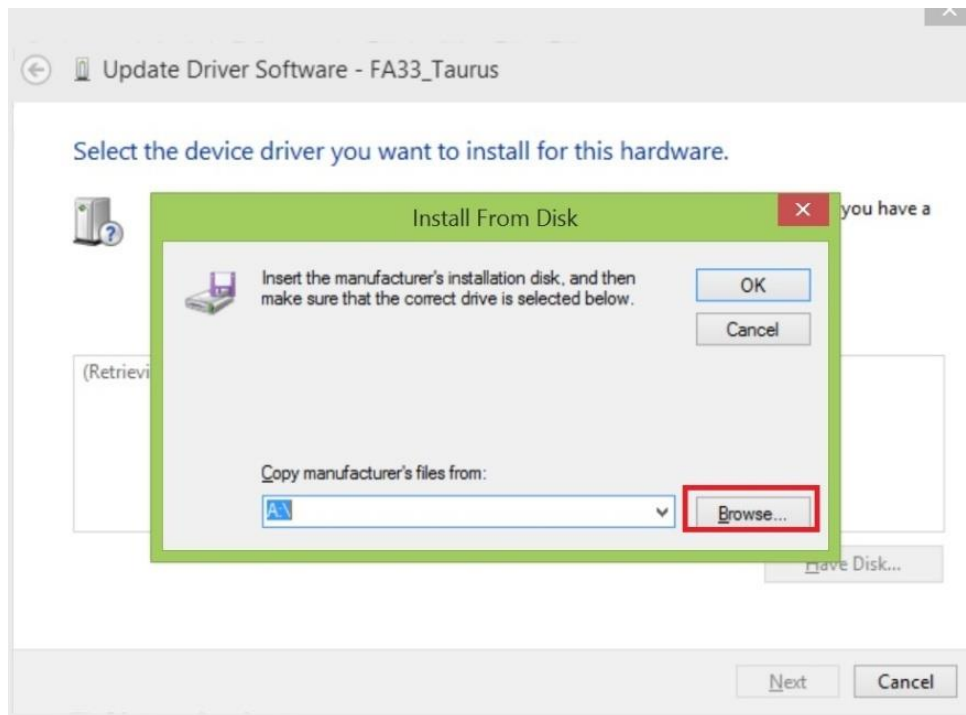

Step 7 Select the driver for your OS system. Click **Open**.

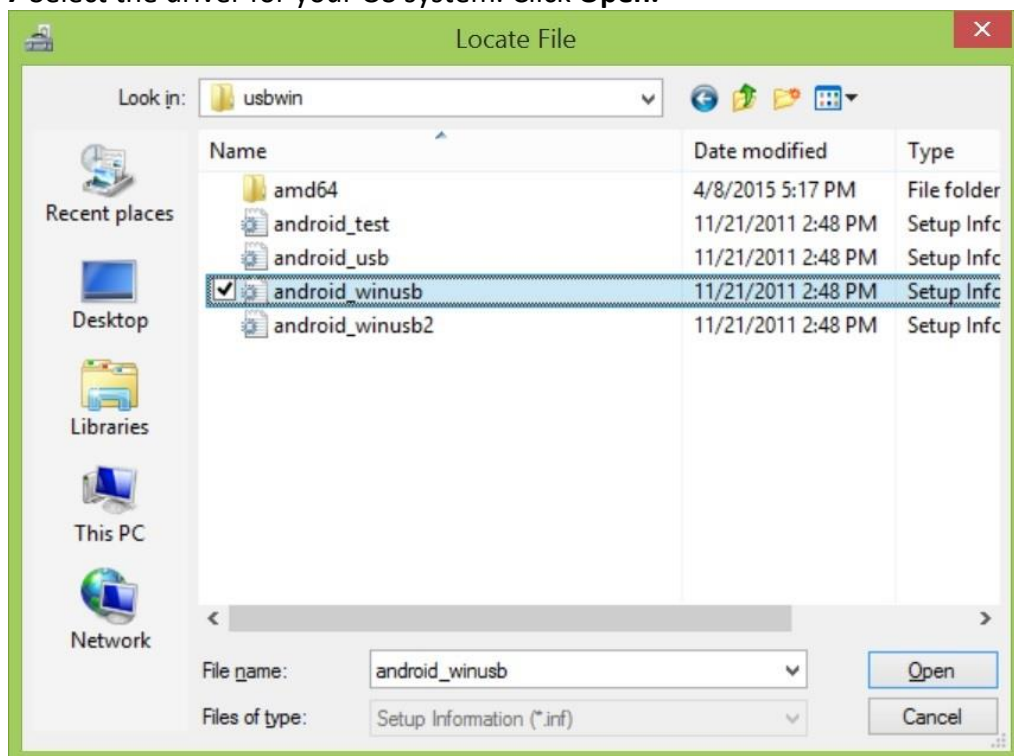

Step 8 Windows Security window will pop up. This message is used to confirm whether the user wants to install the driver. Select **Install this driver software anyway** to continue.



Step 9 When the installation is successfully completed you will see **Android ADB Interface** driver in the Update Driver Software window. Now **adb debug** can be carried out.

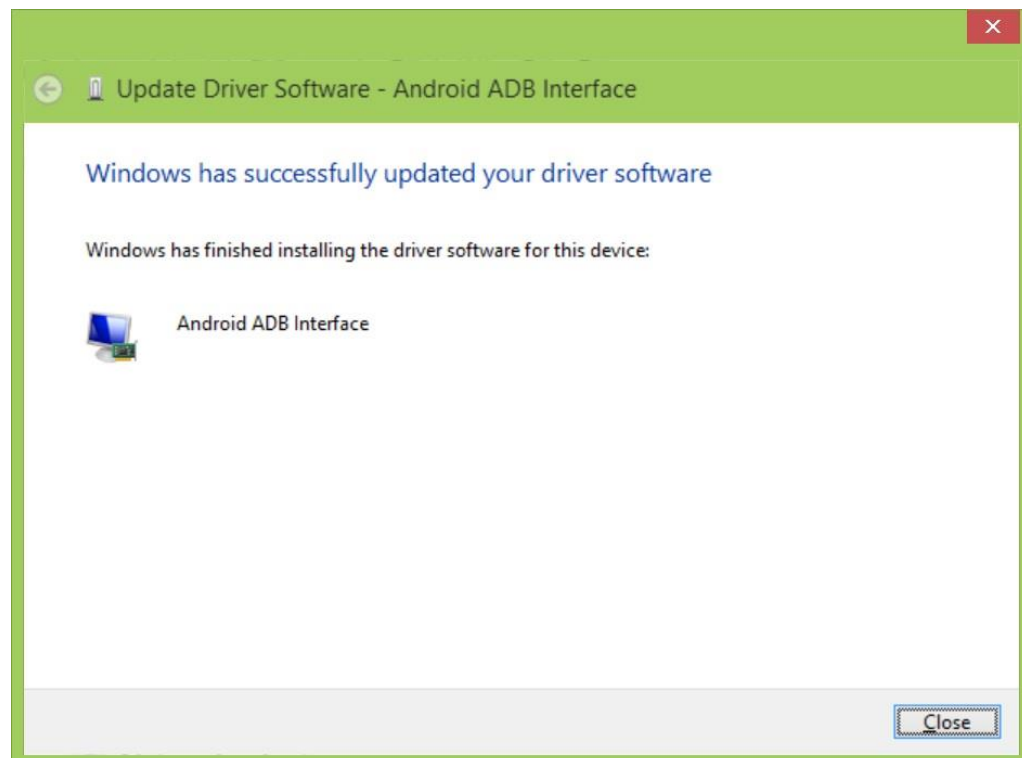

4.2 Installing Android Debug Bridge (ADB)

For detailed Android Debug Bridge (ADB) information refer to Android Developers Platform: <http://developer.android.com/tools/help/adb.html>.

Step 1

Decompress adb.zip. Open ADB terminal and move into the adb archive.

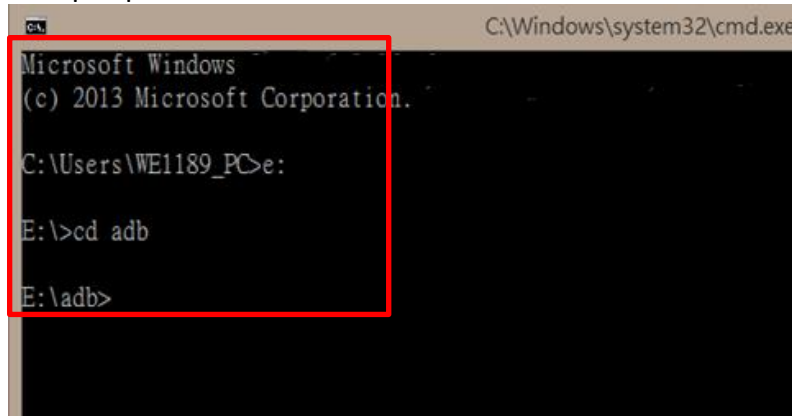

```
C:\Windows\system32\cmd.exe
Microsoft Windows
(c) 2013 Microsoft Corporation.

C:\Users\WE1189_PC>e:
E:\>cd adb
E:\adb>
```

ADB Terminal window

Step 2 Connect the HMI to the computer via USB. FA33 will ask you to confirm USB debugging. Tap **OK**.

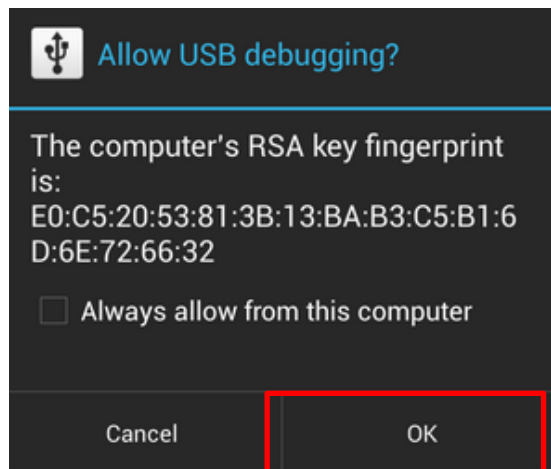

After ADB connection established, install APP or check system log via adb.

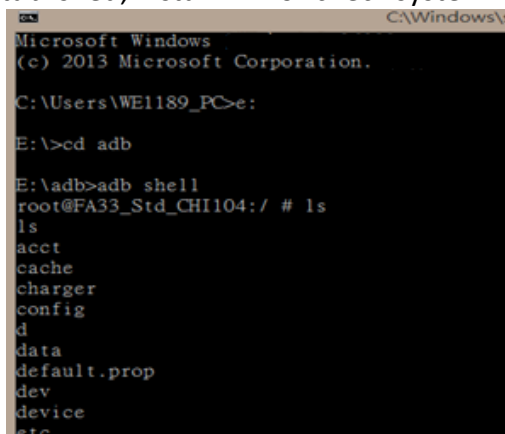

```
C:\Windows\system32\cmd.exe
Microsoft Windows
(c) 2013 Microsoft Corporation.

C:\Users\WE1189_PC>e:
E:\>cd adb
E:\adb>adb shell
root@FA33_Std_CHI104:/ # ls
ls
acct
cache
charger
config
d
data
default.prop
dev
device
etc
```

4.3 OTA Update Guide

OTA is a tool which can help you to update OS image. To receive Android OS image file contact our sales representatives. Once you get the image file follow the guideline below.

1. Copy image files **ota_FA34_X_X_X_X.zip** and **FA34_X_X_X_X.md5** and to micro SD card.
2. Insert micro SD card to the slot in the computer.
In the **APPS** menu tap **OTA Image Upd.**

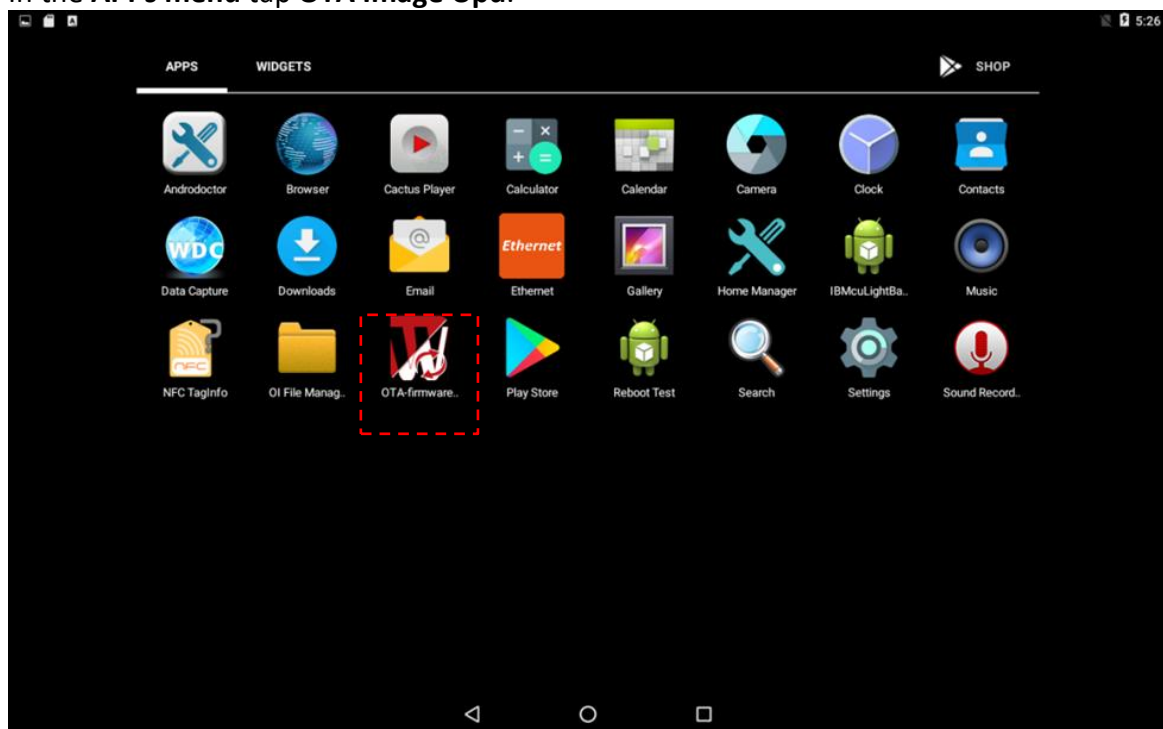

System shows OTA firmware related information.

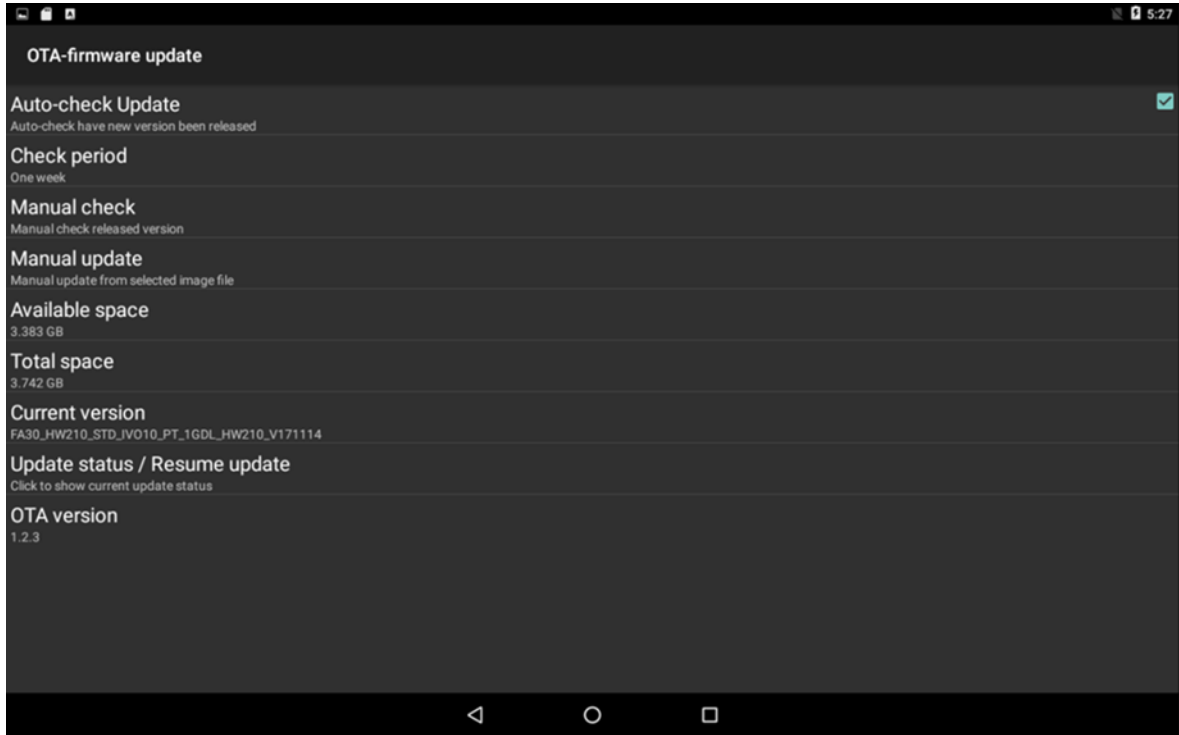

3. Click Auto-check Update. The system is checking OTA File. It may take some time.

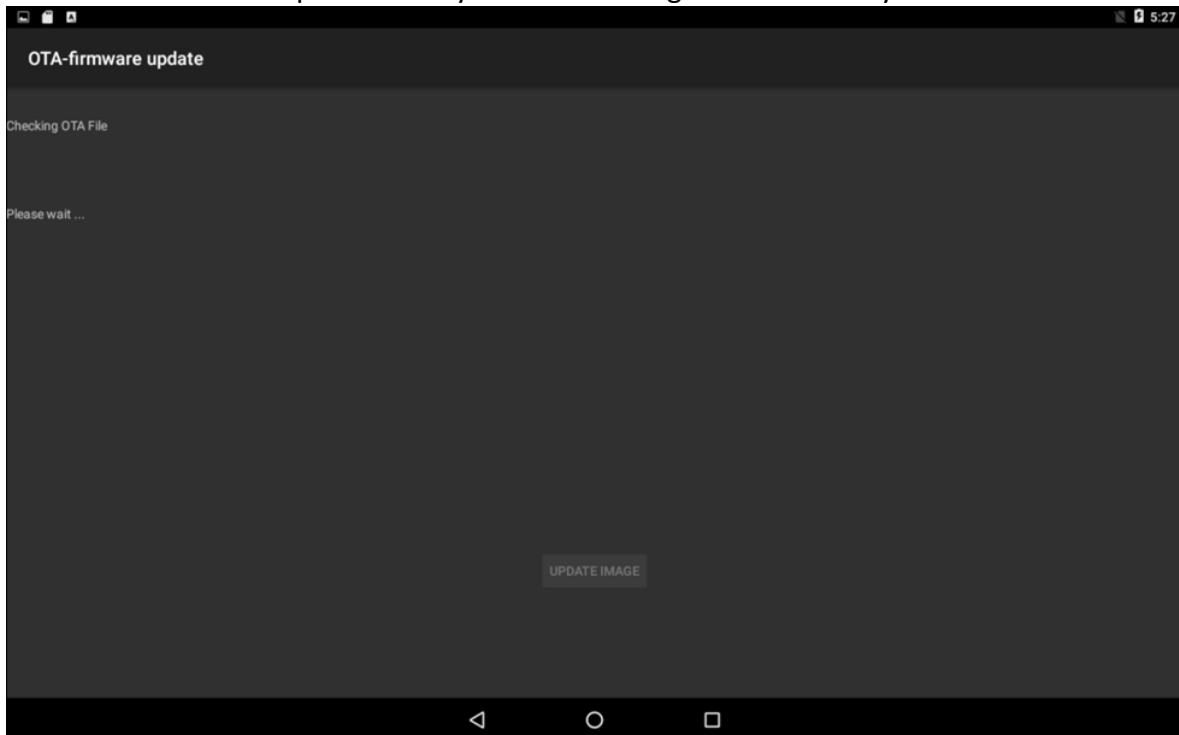

4. Tap Update Image

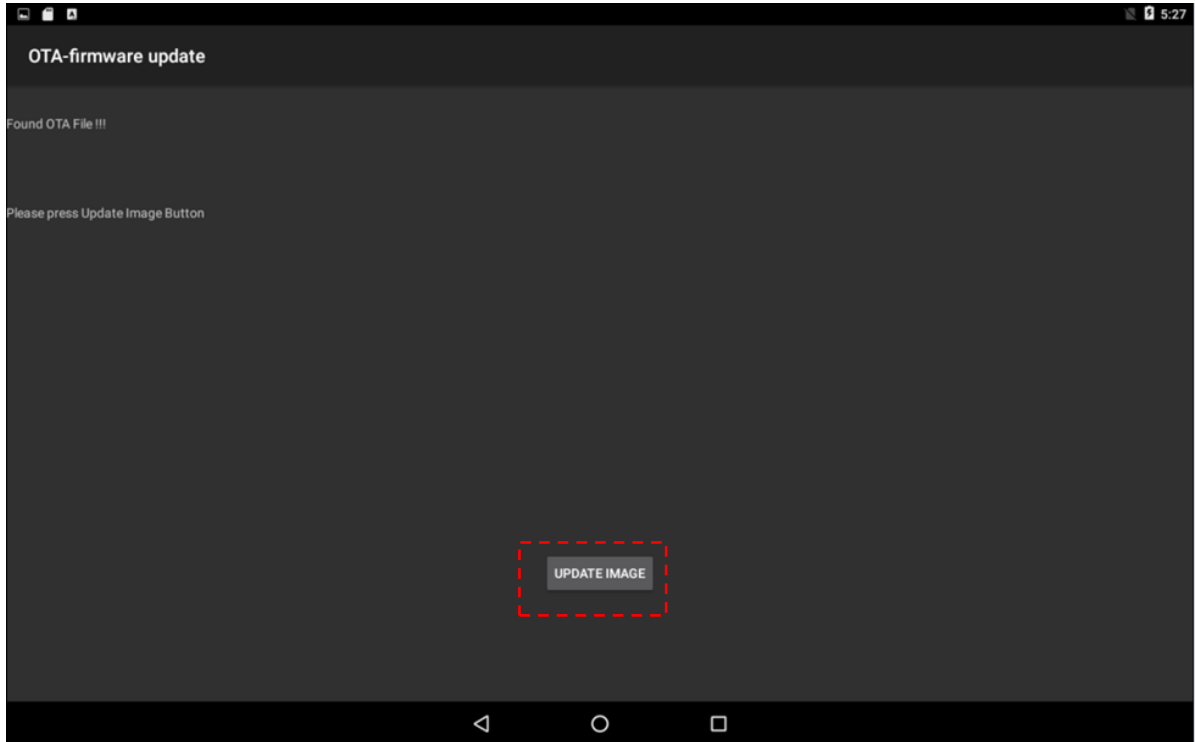

5. Make sure the file founded by the system is image update file. Tap **OK**.

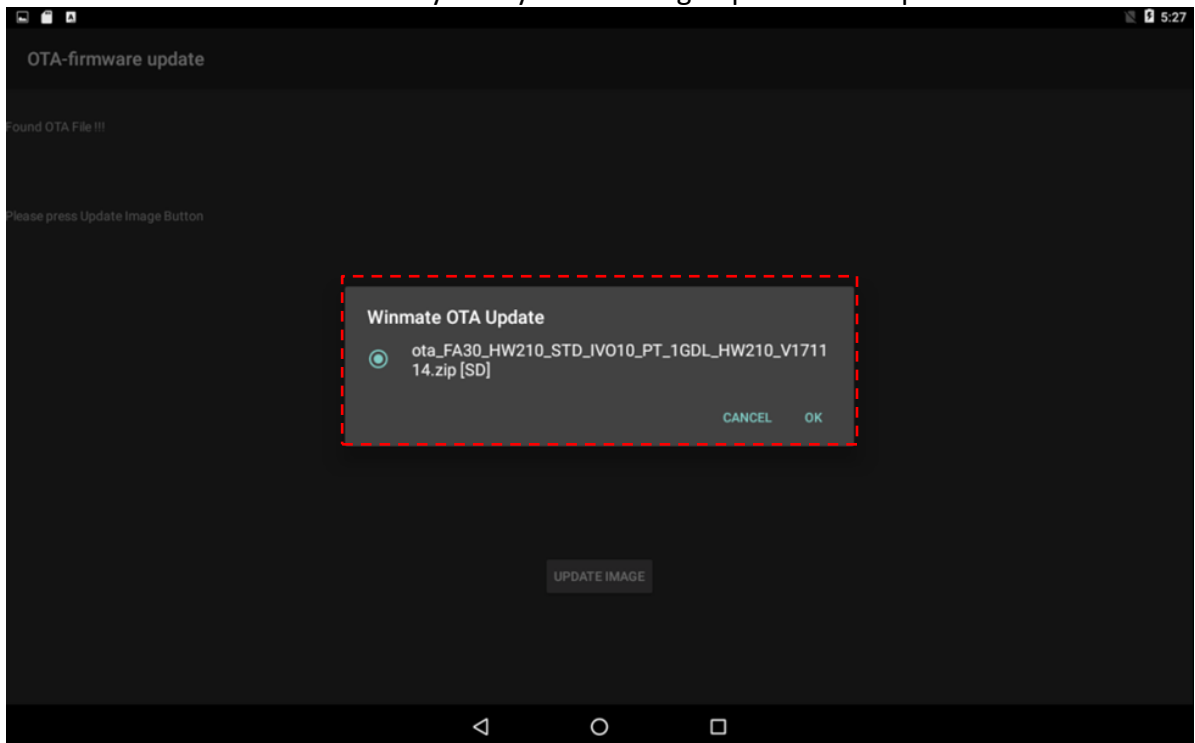

6. Make sure the battery level is at least 50%. Tap **OK**.

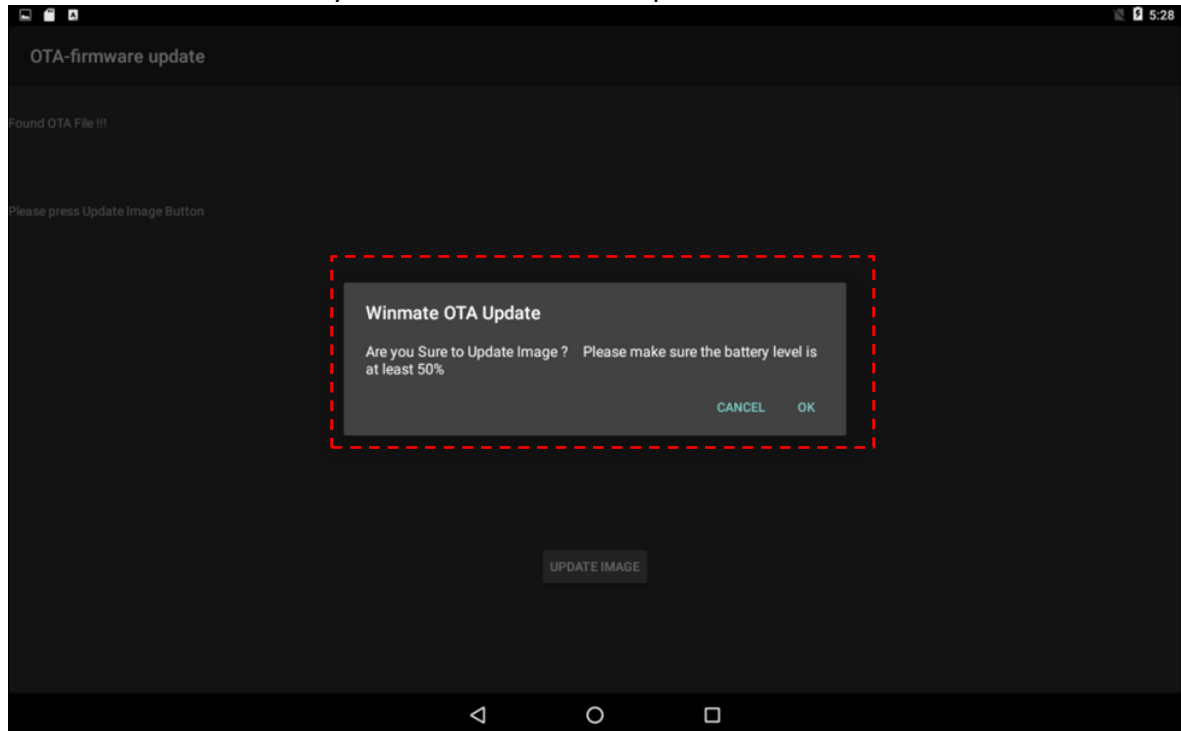

7. Tap **OK**.

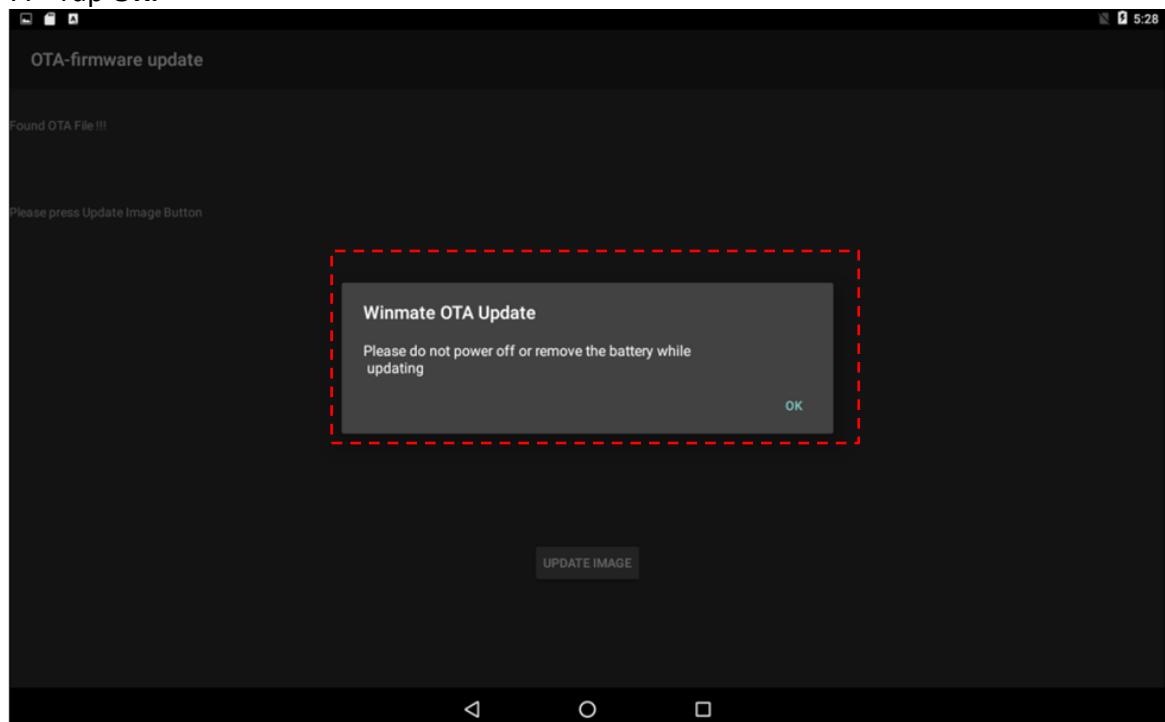

IMPORTANT:

Do not disconnect the power source!
Do not remove the battery!

8. After update the system will automatically restart.

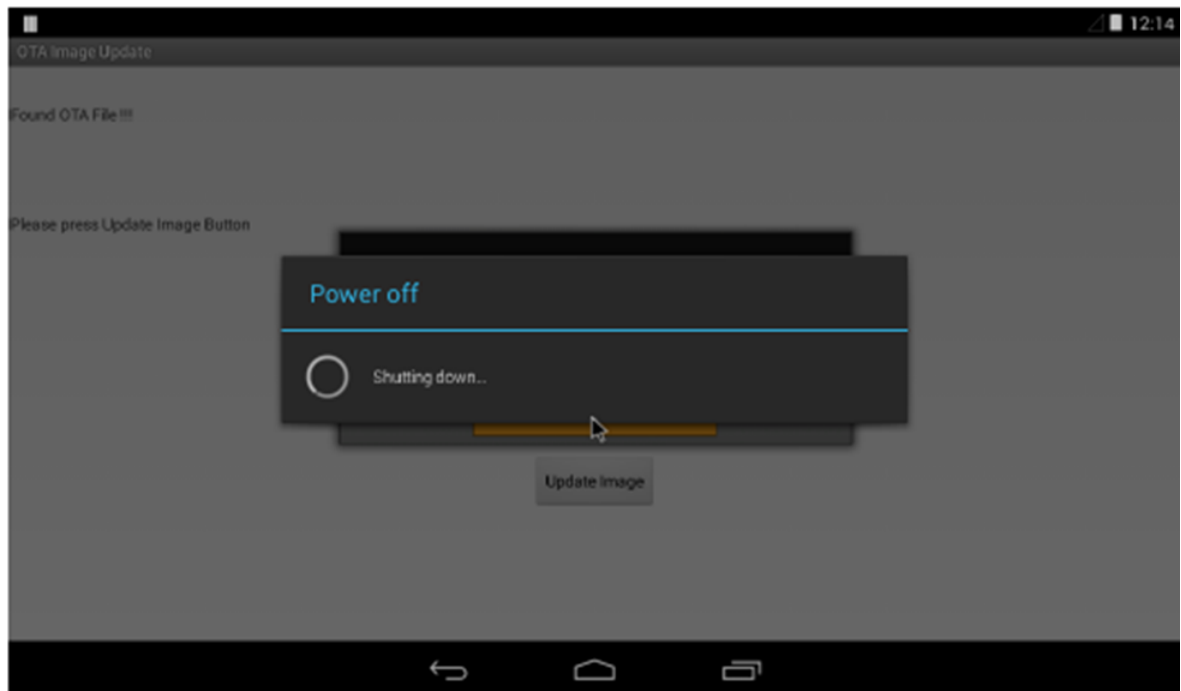

4.4 OS Image Update Guide

Download OS Image update guide from Winmate Download Center or Winmate File Share.

Winmate Download Center:

<http://dc.winmate.com.tw/downloadCenter/2016/Multitouch%20PPC/Download%20Image%20Tool%20User%20Guide.pdf>

Winmate File Share: <https://winmate.box.com/v/FA33-OS-Image-Update-Guide>

MOUNTING

This chapter provides step-by-step mounting guide for all available mounting options.

5

CHAPTER 5: MOUNTING

This chapter provides mounting guide for all available mounting options. Pay attention to cautions and warning to avoid any damages.



WARNING! / AVERTISSEMENT!

Follow mounting instructions and use recommended mounting hardware to avoid the risk of injury.

Suivez les instructions de montage et d'utilisation recommandé le matériel de montage pour éviter le risque de blessure.

5.1 Cable Mounting Considerations

For a nice look and safe installation, make sure cables are neatly hidden behind the Panel PC. Refer to [Chapter 2, section 2.1](#) for the Cable Installation instruction.



WARNING! / AVERTISSEMENT!

Observe all local installation requirements for connection cable type and protection level.

Suivre tous les règlements locaux d'installations, de câblage et niveaux de protection.



WARNING! / AVERTISSEMENT!

Turn off the device and disconnect other peripherals before installation.

Éteindre l'appareil et débrancher tous les périphériques avant l'installation.



ALTERNATING CURRENT / MISE À LE TERRE!

To prevent electrical shock, the Safety Ground location on the rear must be bonded to the local earth ground through a minimum 12 AWG wire as short as possible

Pour éviter les chocs électriques, l'emplacement de la prise terre à l'arrière doit être lié à terre locale, à travers un 12 AWG minimum et aussi court que possible.

5.2 Safety Precautions

Observe the following common safety precautions before installing any electronic device:

- Use separate, non-intersecting paths to route power and networking wires. If power wiring and device wiring paths must be crossed make sure the wires are perpendicular at the intersection point.
- Keep the wires separated according to the interface. Wires that share similar electrical characteristics must be bundled together.
- Do not bundle input wiring with output wiring. Keep them separate.

When necessary, it is strongly advised that you label wiring to all devices in the system.

5.3 Mounting Guide

G-WIN Slim IP65 (P-CAP) devices come with different mounting options suitable for most of the industrial and commercial applications, including heavy duty and agricultural vehicles, forklifts. The main mounting approach is VESA mounting - very user-friendly in terms of installation. Refer to sub-sections below for more details.



CAUTION/ ATTENTION

Follow mounting instructions and use recommended mounting hardware to avoid the risk of injury.

Suivez les instructions de montage et d'utilisation recommandé le matériel de montage pour éviter le risque de blessure.

5.3.1 VESA Mounting

This device supports VESA Mounting and provides various types of mounting options to fit any industrial use or vehicle.

Size	VESA Plate
7", 10.1", 10.4", 12.1"	75x75 mm
10.4", 15"	100x100 mm

Mounting Instruction:

Use Philips M4x5 screws to fix the desk stand to VESA holes on the back cover of the device.

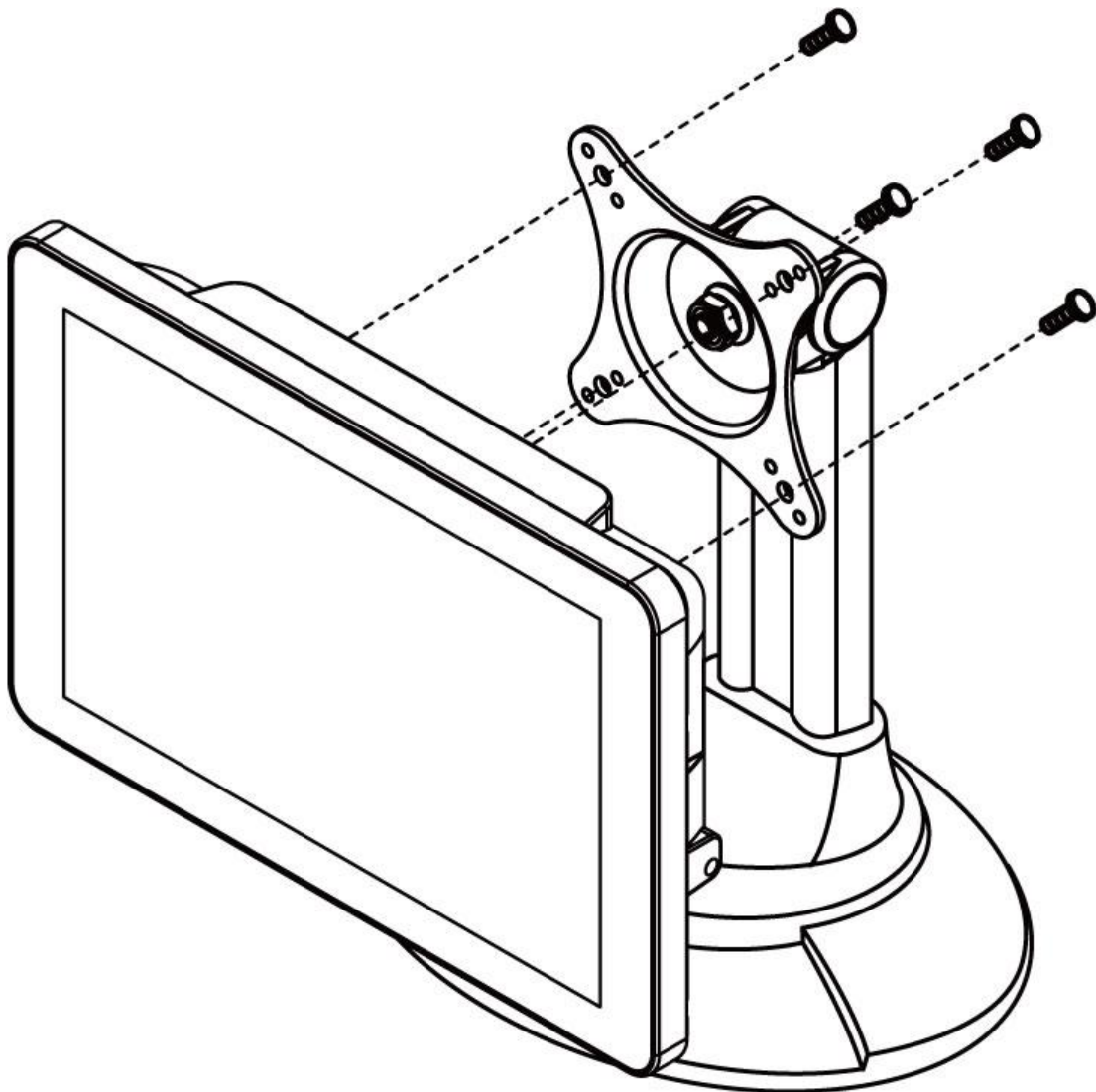

**The picture is for demonstration purposes only. VESA Mounting accessories are not supplied by Winmate.*

5.3.2 Panel Mounting

Panel Mount mounting solutions is suitable for many applications where Panel PC should be embedded. With this mounting solution flat surface leave no bezel in the front.

Size	Wall Cutout, mm	Screw Hole Diameter, mm
7"	174.4 x 130.4	M4x4
10.1"	249 x 157.6	M4x5
10.4"	227 x 174.5	M4x5
12.1"	281 x 206	M4x5
15"	345.4 x 260	M6x4

Mounting Instruction:

1. Prepare a fixture for the specific dimensions of the device.
2. Cut a hole on a sub frame or panel according to the cutout dimensions.
3. Install the device properly onto the cutout area of the sub frame or panel with the sides of the front bezel.
4. Fix the device to fixture with eight Phillips screws.

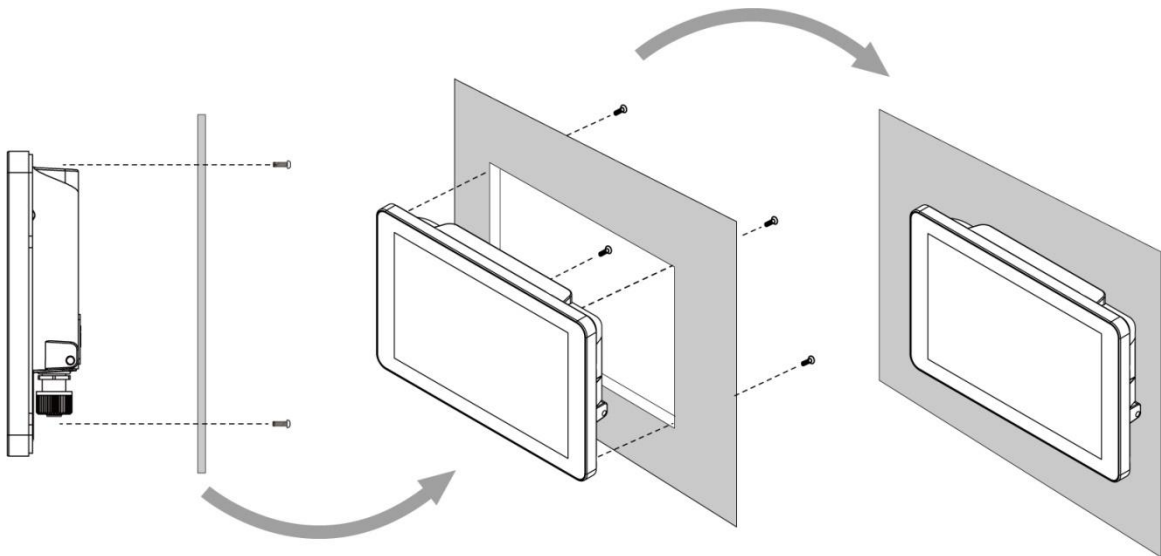

TECHNICAL SUPPORT

This chapter includes pathway to technical support.



CHAPTER 6: TECHNICAL SUPPORT

This chapter includes pathway to technical support and Software Developing Kit (SDK). If any problem occurs fill in Problem Report Form enclosed and immediately contact us.

6.1 Software Developer Support

Download software development documents from Winmate Download Center or Winmate File Portal.

Item	File Type	Description
1	Android SDK	Android Driver Programming Guide
2	Linux SDK	Linux Driver Programming Guide
3	USB Driver	Android USB Driver
4	USB OTG Driver	Android USB OTG Driver

1. Winmate Download Center

Go to www.winmate.com > Support > Download Center > Rugged Series >G-WIN GS65 Panel PC – Cortex A9

Or follow the link:

<http://www.winmate.com/DownCenter/DownLoadCenter.asp?DownType=0913>

2. Android Debug Bridge (ADB)

For detailed Android Debug Bridge (ADB) information refer to Android Developers Platform: <http://developer.android.com/tools/help/adb.html>.

Product Specifications

This section includes product specifications.



APPENDIX A: PRODUCT SPECIFICATIONS

Hardware Specifications

	Model Name				
	W07FA3S-GSO1	W10FA3S-GSH1(HB)	R10FA3S-GST2	R12FA3S-GSM2(HB)	R15FA3S-GSC3(HB)
Display					
Size/Type	7" TFT (Wide)	10.1" TFT (Wide)	10.4"	12.1" TFT	15" TFT
Resolution	1024 x 600	1024 x 600	1024 x 768	1024 x 768	1024 x 768
Brightness	1000 nits	420 nits (Optional 800 nits)	350 nits	500 nits (Optional 1000 nits)	250 nits (Optional 1000 nits)
Contrast Ratio	700:1(typ.)	500:1(typ.)	(Optional 1000 nits)	700:1(typ.)	700:1 (typ.)
Viewing Angle	-75~75(H); -75~70(V)	-70~70(H); -60~50(V)	1200:1 (typ.)	-80~80(H) ; -70~70(V)	-80~80(H); 70~70(V)
Max Colors	262K(6bit)	262K(6bit)	-88~88(H); -88~88(V)	16.2M	16.2M(8bit)
Touch	Projected Capacitive Multi-Touch (P-CAP) with optional protection glass				
System					
Processor	Freescale® Cortex® A9 i.MX6 Quad Core 1 GHz				
System Memory	1GB LPDDR3				
Storage	Onboard 16GB eMMC (Default) or Micro SD card				
Operating System					
Operating System	Android 6.0 (Default) Linux Kernel 4.1.15, QT 5.5 Browser (Optional) Ubuntu 16.04 (Optional)				

Input/ Output					
COM Port	1 x RS232/422/485 (M12 Type)				
USB Port	1 x USB 2.0 (M12 Type), 1 x USB OTG (On side)				
Ethernet	1 x 10/100/100 LAN (M12 Type)				
Speaker	1 x 1 Watt Speaker				
SD Slot	MicroSD Card Slot				
Power Specifications					
Power Input	9-24V DC	12V DC	12V DC	12V DC	12V DC
Power Consumption	10W	15W	15W	15W	20W
Mechanical Specifications					
Cooling	Fanless Design				
Mounting	VESA Mounting, Panel Mounting				
Environment Considerations					
Operating Temperature	-10°C to +55°C				
Operating Humidity	30% to 90% (non-condensing)				
IP Rating	Full IP65				
Shock	Operating: 40g for 11 ms, 300 m/s^2				
Vibration	Operating: 1.48/1.98/2.24g rms for XYZ/ 5-500Hz				
Standards and Certification					
Safety	CE, FCC				
Shock, Vibration	Comply with MIL-STD-810F/G for shock/ vibration				

Software Support

Item	File Type	Description
1	Programming Guide	For Android
2	Programming Guide	For Linux



Winmate Inc.

9F, No.111-6, Shing-De Rd., San-Chung District,
Taipei 241, Taiwan, R.O.C

Tel: 886-2-8511-0288

Fax: 886-2-8511-0211

Email: sales@winmate.com.tw

Official website: www.winmate.com