

SDI Display

10.1~32"

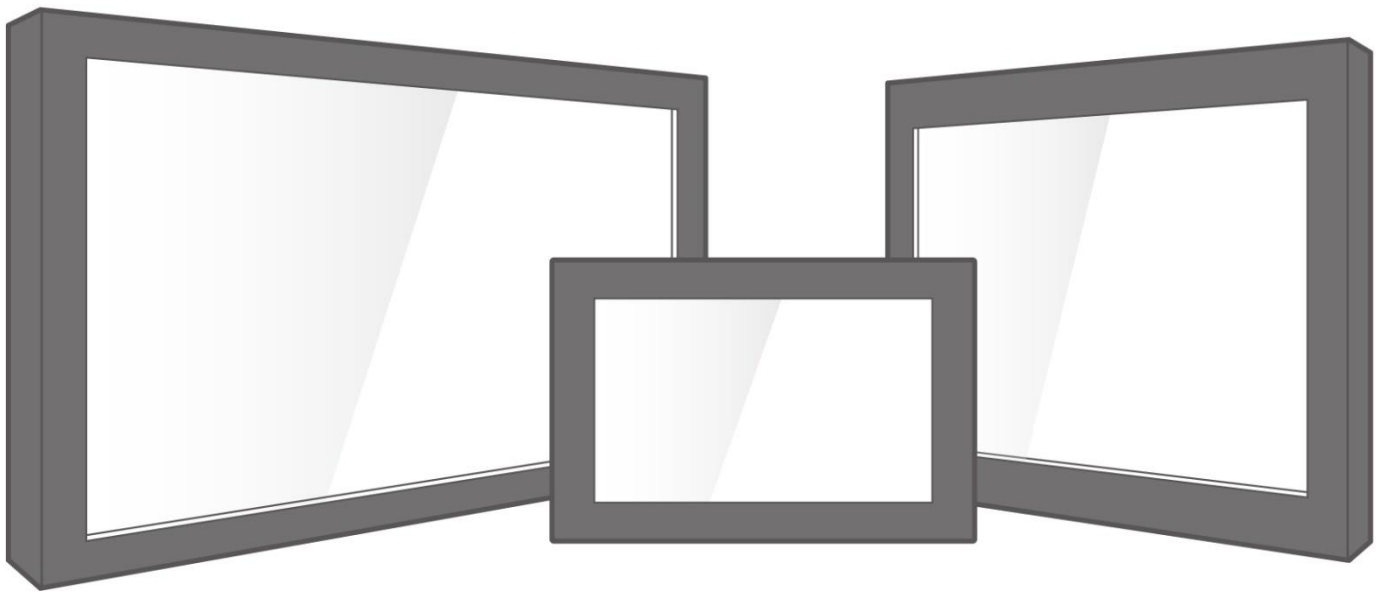

User Manual

Contents

Preface	3
About This User Manual.....	6
Chapter 1: Introduction	7
1.1 Overview	8
1.2 Product Features.....	8
1.3 Package Contents.....	8
1.4 Product Overview	9
1.5 Interfaces	10
1.6 OSD Control Panel.....	11
1.7 OSD Hot Keys	11
Chapter 2: Installation	12
2.1 Wiring Requirements.....	13
2.2 Cable Mounting Considerations	13
2.3 Connecting Power.....	13
2.4 Mounting Guide.....	14
2.5 Connecting Peripherals	15
2.5.1 VGA Connector	15
2.5.2 HDMI Connector.....	15
2.5.3 3G-SDI Output Connector	16
2.5.4 3G-SDI Input Connector	16
2.5.5 CVBS Connector	16
2.5.6 Power Input Connector.....	16
3.1 Turning on the System	17
Chapter 3: Operating the Device	18
3.2 OSD Menu Navigation.....	19
3.3 Troubleshooting Guide.....	21
Appendix	22
Appendix A: Frequency Table	23

Preface

Copyright Notice

No part of this document may be reproduced, copied, translated, or transmitted in any form or by any means, electronic or mechanical, for any purpose, without the prior written permission of the original manufacturer.

Trademark Acknowledgement

Brand and product names are trademarks or registered trademarks of their respective owners.

Disclaimer

We reserve the right to make changes, without notice, to any product, including circuits and/or software described or contained in this manual in order to improve design and/or performance. We assume no responsibility or liability for the use of the described product(s) conveys no license or title under any patent, copyright, or masks work rights to these products, and make no representations or warranties that these products are free from patent, copyright, or mask work right infringement, unless otherwise specified. Applications that are described in this manual are for illustration purposes only. We make no representation or guarantee that such application will be suitable for the specified use without further testing or modification.

Warranty

Our warranty guarantees that each of its products will be free from material and workmanship defects for a period of one year from the invoice date. If the customer discovers a defect, we will, at his/her option, repair or replace the defective product at no charge to the customer, provide it is returned during the warranty period of one year, with transportation charges prepaid. The returned product must be properly packaged in its original packaging to obtain warranty service. If the serial number and the product shipping data differ by over 30 days, the in-warranty service will be made according to the shipping date. In the serial numbers the third and fourth two digits give the year of manufacture, and the fifth digit means the month (e. g., with A for October, B for November and C for December).

For example, the serial number 1W16Axxxxxxx means October of year 2016.

Customer Service

We provide a service guide for any problem by the following steps: First, visit the website of our distributor to find the update information about the product. Second, contact with your distributor, sales representative, or our customer service center for technical support if you need additional assistance.

You may need the following information ready before you call:

- Product serial number
- Software (OS, version, application software, etc.)
- Description of complete problem
- The exact wording of any error messages

In addition, free technical support is available from our engineers every business day. We are always ready to give advice on application requirements or specific information on the installation and operation of any of our products.

Naming Rule

R10LXXX-SDXX

Item	Description
R	Panel Type
10	Panel Size
LXXX	Product Size
SD	Mechanical Type (SDI)
XX	Panel Model

Advisory Conventions

Four types of advisories are used throughout the user manual to provide helpful information or to alert you to the potential for hardware damage or personal injury. These are Notes, Important, Cautions, and Warnings. The following is an example of each type of advisory.



Note:

A note is used to emphasize helpful information



Important:

An important note indicates information that is important for you to know.



Caution/ Attention

A Caution alert indicates potential damage to hardware and explains how to avoid the potential problem.

Unéalerted' attention indique un dommage possible à l'équipement et explique comment éviter le problem potentiel.



Warning!/ Avertissement!

An Electrical Shock Warning indicates the potential harm from electrical hazards and how to avoid the potential problem.

Un Avertissement de Choc Électrique indique le potentiel de choc sur des emplacements électriques et comment éviter ces problèmes.



Alternating Current / Mise à la Terre

The Protective Conductor Terminal (Earth Ground) symbol indicates the potential risk of serious electrical shock due to improper grounding.

Le symbole de Mise à Terre indique le risqué potentiel de choc électrique grave à la terre incorrecte.

Safety Information

Warning!/ Avertissement!



Always completely disconnect the power cord from your chassis whenever you work with the hardware. Do not make connections while the power is on. Sensitive electronic components can be damaged by sudden power surges. Only experienced electronics personnel should open the PC chassis.

Toujours débrancher le cordon d'alimentation du chassis lorsque vous travaillez sur celui-ci. Ne pas brancher de connections lorsque l'alimentation est présente. Des composants électroniques sensibles peuvent être endommagés par des sauts d'alimentation. Seulement du personnel expérimenté devrait ouvrir ces chassis.

Caution/ Attention



Always ground yourself to remove any static charge before touching the CPU card. Modern electronic devices are very sensitive to static electric charges. As a safety precaution, use a grounding wrist strap at all times. Place all electronic components in a static-dissipative surface or static-shielded bag when they are not in the chassis.

Toujours vérifier votre mise à la terre afin d'éliminer toute charge statique avant de toucher la carte CPU. Les équipements électroniques modernes sont très sensibles aux décharges d'électricité statique. Toujours utiliser un bracelet de mise à la terre comme précaution. Placer toutes les composantes électroniques sur une surface conçue pour dissiper les charge, ou dans un sac anti-statique lorsqu'elles ne sont pas dans le chassis.

Safety Precautions

For your safety carefully read all the safety instructions before using the device. Keep this user manual for future reference.

- Always disconnect this equipment from any AC outlet before cleaning. Do not use liquid or spray detergents for cleaning. Use a damp cloth.
- For pluggable equipment, the power outlet must be installed near the equipment and must be easily accessible.
- Keep this equipment away from humidity.
- Put this equipment on a reliable surface during installation. Dropping it or letting it fall could cause damage.
- The openings on the enclosure are for air convection and to protect the equipment from overheating.
- Before connecting the equipment to the power outlet make sure the voltage of the power source is correct.
- Position the power cord so that people cannot step on it. Do not place anything over the power cord.
- If the equipment is not used for a long time, disconnect it from the power source to avoid damage by transient over-voltage.
- Never pour any liquid into an opening. This could cause fire or electrical shock.
- Never open the equipment. For safety reasons, only qualified service personnel should open the equipment.
- All cautions and warnings on the equipment should be noted.

**Caution/ Attention**

Always ground yourself to remove any static charge before touching the board. Modern electronic devices are very sensitive to static electric charges. As a safety precaution, use a grounding wrist strap at all times. Place all electronic components in a static-dissipative surface or static-shielded bag when they are not in the chassis.

**Caution/ Attention**

Do not cover the openings!

About This User Manual

This User Manual provides information about using the Winmate® SDI Display. The documentation set provides information for specific user needs, and includes:

- **SDI Display User Manual** – contains detailed description on how to use the display, its components and features.

**Note:**

Some pictures in this guide are samples and can differ from actual product.

Document Revision History

Version	Date	Note
1.0	25-Jan-2019	New document release.

Chapter 1: Introduction

This chapter gives you product overview, describes features and hardware specification. You will find all accessories that come with the display device in the packing list. Mechanical dimensions and drawings included in this chapter.

1.1 Overview

Congratulations on purchasing Winmate® SDI Display. When you need high quality SDI monitoring, Winmate monitors are the perfect solution! Long distance up to 100 meters transmission with no data compression with 3G SDI input and output.

1.2 Product Features

Winmate® SDI Display features:

- 10.1~32" TFT LCD
- 1x HDMI, 1x VGA, 2 x CVBS (BNC)
- 1 x 3G-SDI in, 1 x 3G-SDI out (loop out)
- Chassis housing
- Sleek and flush mounts
- Suitable for industrial applications

1.3 Package Contents

Carefully remove the box and unpack your display. Please check if all the items listed below are inside your package. If any of these items are missing or damaged contact us immediately.

Standard factory shipment list:



- **Display**

Varies by product



- **User Manual (Hardcopy)**

Part No. 915211101040



- **Black screw bolts****

Varies by product

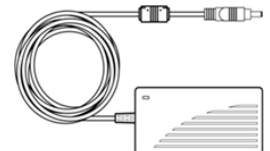

- **110~240V AC Power Adapter**

Varies by product

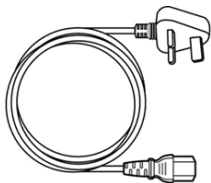

- **Power Cord**

Varies by country

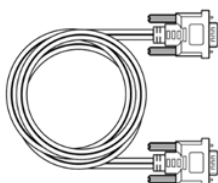

- **VGA Cable**

Part No. 9441151150P4

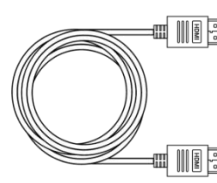

- **HDMI Cable**

Part No. 94E0190190P3

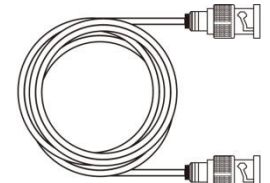

- **SDI Cable**

Part No. 9470020020K1

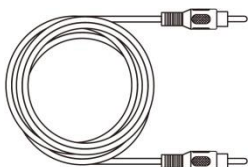

- **CVBS cable**

Part No. 947018102000

****Notice:** Screw bolts provided by Winmate only to be used to screw the display onto a console from the rear side. If you prefer your own bolts, please make sure to use M4 and 30mm in length.

1.4 Product Overview

This section describes physical appearance of the SDI Display.



Note:

Notice that standard input terminals include VGA and HDMI. Your device may be equipped with DVI, S-Video or Composite input terminals based on your order.

Notice that input and output connectors vary by product size and specifications. The picture above shows only a prototype model for information purposes only.

Mechanical dimensions and appearance

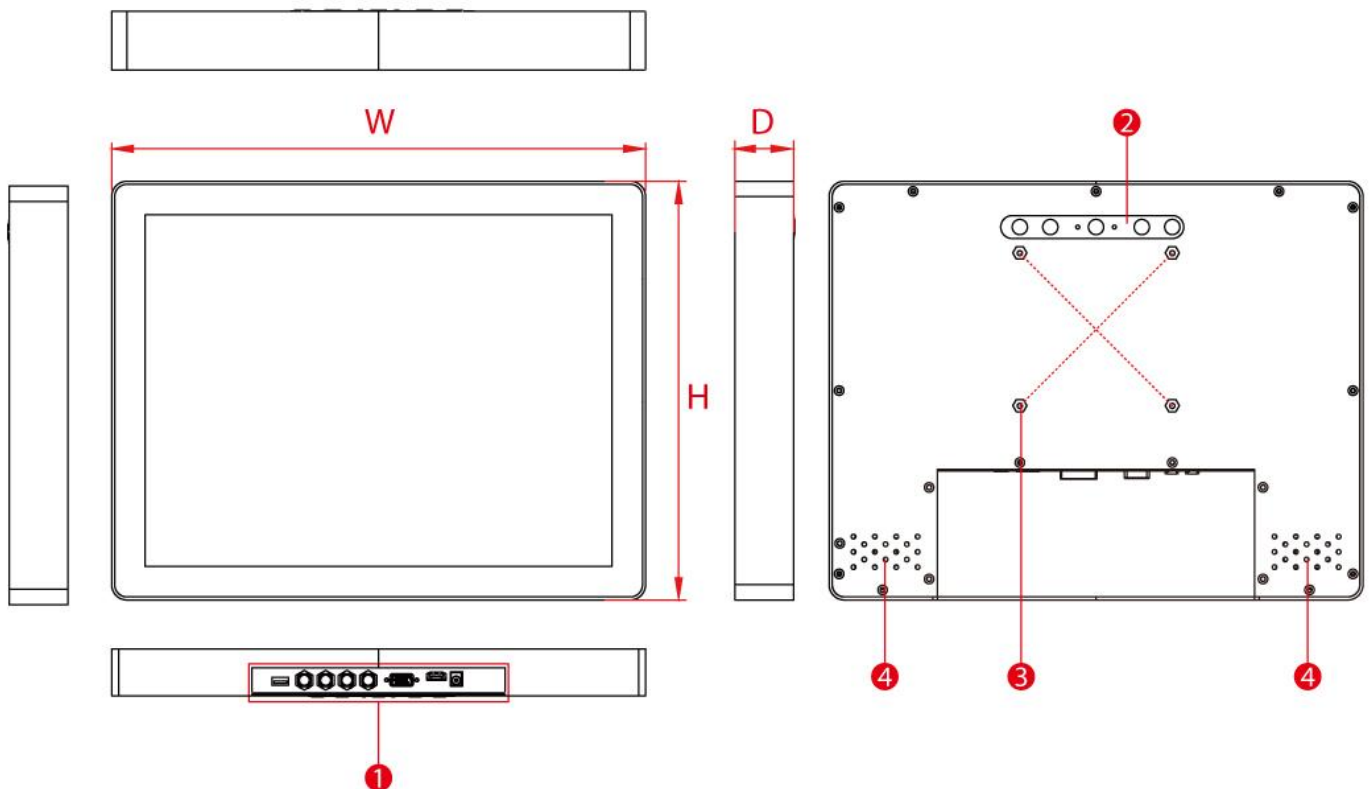

Notice that input and output connectors vary by product size and specifications. The picture above shows only a prototype model for information purposes only.







Item	Description
①	Connectors – Display input and output connects. The choice varies by order specifications.
②	OSD Control Panel – On-screen display control panel consists of physical buttons and LED indicators.
③	VESA – VESA pattern for wall, desk mounting.
④	Speaker – Audio output. Optional feature.

Refer to the table below for a unit dimensions.

Panel Size	Model Name	Dimensions (W x H x D, mm)	VESA (W x H), mm
10.1"	W10L100-SDH2	263.6 x 172.3 x 38.5	75 x 75
15"	R15L100-SDA3	350.2 x 274.2 x 38.5	100 x 100
19"	R19L300-SDA1	438.7 x 363.5 x 38.9	100 x 100
21.5"	W22L100-SDA3	518.1 x 314 x 38.5	100 x 100
32"	W32L100-SDA3	775.6 x 475.6 x 55	200 x 200

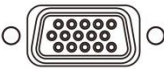
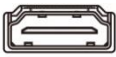
1.5 Interfaces

Display input and output connectors are located on the bottom side.

Item	Description
	Power Jack – Connects computer to source of power.
	USB for Touch - Connects USB for touch capabilities.
	VGA (RGB) –Transmits video from a PC to a monitor. <i>Example: A notebook PC to a monitor.</i>
	HDMI 1.3 – Transmits and protects copyrighted digital video and audio. <i>Example: An HD tuner to an HD ready TV.</i>
	3G-SDI output - Transmits 3G SDI analog signals from display.
	3G-SDI input - Transmits 3G SDI analog signals to display.
	CVBS - Transmits CVBS analog signals to display.

1.6 OSD Control Panel

OSD control panel varies by product specifications. Physical buttons and LED indicators are located on the OSD control panel the rear side of the display.

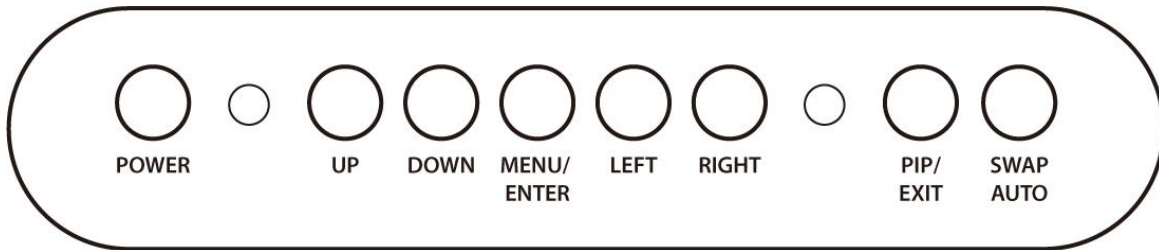

Control Buttons

Icon	Function
	POWER - Initiates power-up sequence from low power mode or enters low power mode from normal operation.
	UP - Selects the previous item in the Menu.
	DOWN - Selects the next item in the Menu.
	MENU/ ENTER i. When OSD is disabled, it displays the OSD Main Menu. ii. When OSD is enabled, it confirms a selection.
	LEFT - Moves left in the menu or bar.
	RIGHT - Moves right in the menu or bar.
	EXIT - i. When OSD is enabled, it returns to the previous menu level or closes the OSD.
	AUTO - Perform Auto Adjustment.

1.7 OSD Hot Keys

Function	Hot Key
Main source	Press “▶” to select the main source.
Volume	Press “◀” to the volume bar, and press “◀” “▶” to adjust the volume.
Auto adjustment	Press “AUTO” to perform auto adjustment.

Chapter 2: Installation

This chapter provides hardware installation instructions and mounting guide for all available mounting options. Pay attention to cautions and warning to avoid any damages

2.1 Wiring Requirements

The following common safety precautions should be observed before installing any electronic device:

- Strive to use separate, non-intersecting paths to route power and networking wires. If power wiring and device wiring paths must cross make sure the wires are perpendicular at the intersection point.
- Keep the wires separated according to interface. The rule of thumb is that wiring that shares similar electrical characteristics may be bundled together.
- Do not bundle input wiring with output wiring. Keep them separate.
- When necessary, it is strongly advised that you label wiring to all devices in the system.



Caution

- Do not run signal or communication wiring and power wiring in the same conduit. To avoid interference, wires with different signal characteristics (i.e., different interfaces) should be routed separately.
- Be sure to disconnect the power cord before installing and/or wiring your device.
- Verify the maximum possible current for each wire gauge, especially for the power cords. Observe all electrical codes dictating the maximum current allowable for each wire gauge.
- If the current goes above the maximum ratings, the wiring could overheat, causing serious damage to your equipment.

Be careful when handling the unit. When the unit is plugged in, the internal components generate a lot of heat which may leave the outer casing too hot to touch.

2.2 Cable Mounting Considerations

For a nice look and safe installation, make sure cables are neatly hidden behind the device.

Caution/ Attention



Observe all local installation requirements for connection cable type and protection level.

Suivre tous les règlements locaux d'installations, de câblage et niveaux de protection.

Caution/ Attention



Turn off the device and disconnect other peripherals before installation.

Éteindre l'appareil et débrancher tous les périphériques avant l'installation.

2.3 Connecting Power

This section provides information on how to use connectors on the Chassis Display. Be cautious while working with these modules. Please carefully read the content of this chapter in order to avoid any damages.

Installation instruction:

1. Connect the AC cord to the AC IN terminal on the AC adaptor.
2. Connect the DC OUT terminal of the AC adaptor to the DC IN terminal on the monitor.
3. Align the notch on the cord connector with the guiding groove and plug it in.
4. Connect the AC cord plug to the power outlet.

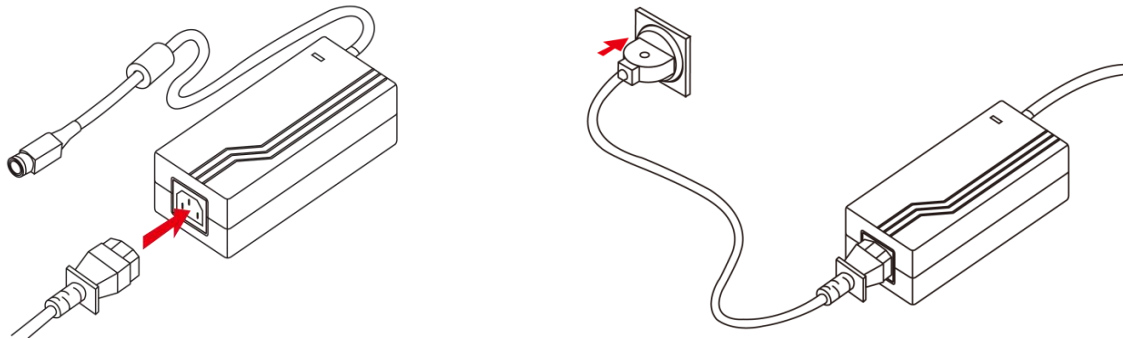
**2.4 Mounting Guide**

The SDI Display can be applied for several different installation methods, including chassis mounting, VESA mounting. Refer to sub-sections below for more details.

**Caution/ Attention**

Follow mounting instructions and use recommended mounting hardware to avoid the risk of injury.

Suivez les instructions de montage et d'utilisation recommandé le matériel de montage pour éviter le risque de blessure.

VESA Mount

SDI Display comes with VESA Mount holes for mounting.

Installation Instruction:

1. Screw VESA bracket to the fixture (ex. swing arm) with four VESA screws.
2. Place the device on VESA bracket.

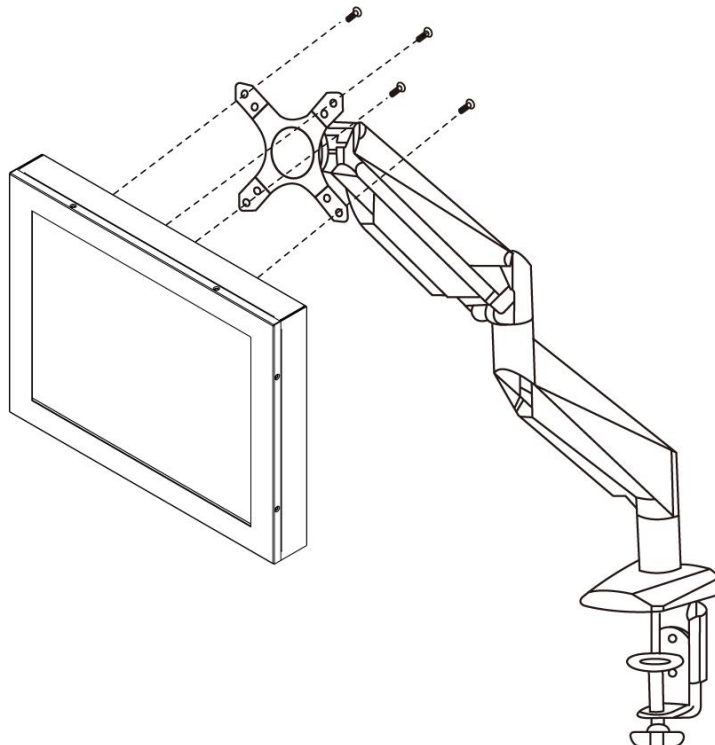

Notice that VESA stand and mounting kit are not provided by Winmate.

2.5 Connecting Peripherals

The panel control port is designed for monitors that work with a variety of compatible video sources. Due to the possible deviations between these signal sources, you may have to make adjustments to the monitor settings from the OSD menu when switching between these sources.



Note:

Notice that standard input terminals include VGA and HDMI. Your device may be equipped with DVI-D, S-Video or Composite input terminals based on your order.

2.5.1 VGA Connector

Chassis Display uses standard 15pin D-sub connector. Plug 15-pin VGA signal cable to the VGA connector in the rear of motherboard, and plug the other end to the monitor. Secure cable connectors with hexagonal copper pillars M3x4mm.

Pin assignment and signal names of VGA connector

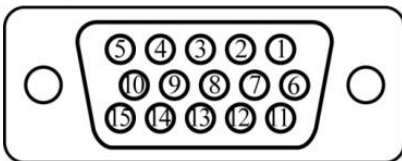

Pin №	Signal Name	Pin №	Signal Name
1	RED	2	GREEN
3	BLUE	4	NC
5	GND	6	AGND
7	AGND	8	AGND
9	VGA_5V	10	GND
11	NC	12	DDCSDA
13	H Sync	14	V Sync
15	DDCSCL		

2.5.2 HDMI Connector

Plug HDMI signal cable to the HDMI connector on the rear side of PC system, and plug the other end to the monitor.

Pin assignment and signal names of HDMI connector

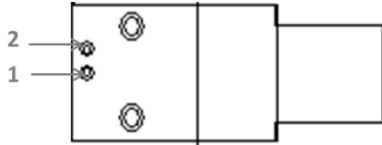

Pin №	Signal Name	Pin №	Signal Name
1	HDMI_RX2+	2	GND
3	HDMI_RX2-	4	HDMI_RX1+
5	GND	6	HDMI_RX1-
7	HDMI_RX0+	8	GND
9	HDMI_RX0-	10	HDMI_RXC+
11	GND	12	HDMI_RXC-
13	HDMI_CON_CEC	14	NC
15	HDMI_CON_SCL	16	HDMI_CON_SDA
17	GND	18	+5V_HDMI
19	HDMI_CON_HP		

2.5.3 3G-SDI Output Connector*Pin assignment and signal names of 3G-SDI output connector*

Pin No	Signal Name
1	SDI_OUTPUT
2	GND

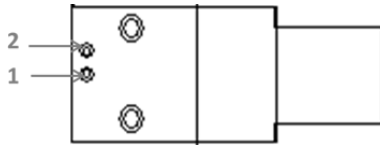
2.5.4 3G-SDI Input Connector*Pin assignment and signal names of 3G-SDI input connector*

Pin No	Signal Name
1	SDI_INPUT
2	GND

2.5.5 CVBS Connector*Pin assignment and signal names of CVBS connector*

Composite Video Signal

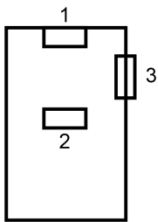
2.5.6 Power Input Connector*Pin assignment and signal names of power jack connector*

Pin No	Signal Name
1	+12V DC
2	GND
3	Case GND

3.1 Turning on the System

To turn on the system:

1. Connect the power adapter cable to the DC IN of the display.
2. Connect the power cord to the power adapter.
3. Connect the power cord to a power outlet.
4. Press the power button located on the OSD control panel on the rear to turn on the system.

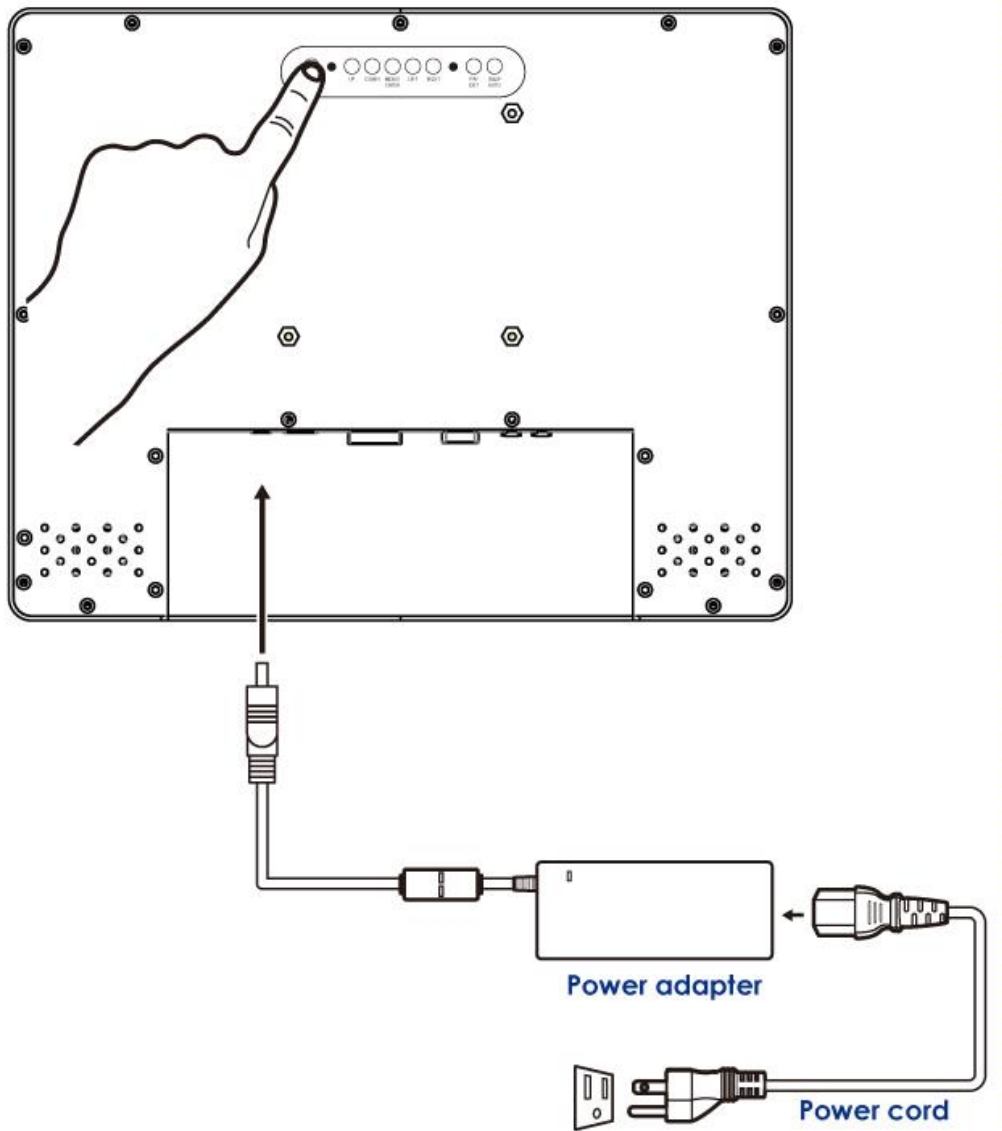





Chapter 3: Operating the Device

In this chapter you will find instructions on how to operate the display.

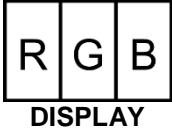
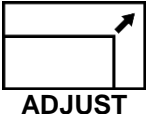

3.2 OSD Menu Navigation

OSD Icon	Sub-menu	Settings	Note
	BRIGHTNESS	slider bar	Default 50
	Use to adjust the screen's brightness. Range 0 to 100		
	CONTRAST	slider bar	Default 50
	Use to adjust the screen's contrast. Range 0 to 100		
	SHARPNESS	slider bar	Default 50
	Use to adjust the screen's sharpness. Range 0 to 100		
	ADC BRIGHTNESS	slider bar	Default 50
	Use to adjust the screen's ADC brightness. Range 0 to 100		
	HUE	slider bar	Default 50 CVBS Only
	Use to adjust the screen's HUE. Range 0 to 100		
	SATURATION	slider bar	Default 50 CVBS Only
	Use to adjust the screen's Saturation. Range 0 to 100		
	COLOR TEMPERATURE	User/ 6500/ 9300	User
	Adjusts the color temperature of the entire screen		
COLOR CONTROL	R slider bar G slider bar B slider bar	Default 50	
Use to adjust the screen's R,G,B color. Range 0 to 100			
GAMMA	NATIVE/ 1.8/ 2.2	NATIVE	
Select a display gamma value for best picture quality.			
	AUTO SETUP (VGA only)	Press ENTER	Default OFF
	Automatically adjusts screen size, H position, V position, Clock, Clock Phase		
	AUTO ADJUSTMENT (VGA only)	ON/ OFF	Default OFF
	H Position, V Position and Clock Phase are adjusted automatically upon power on.		
	H POSITION (VGA)	Slider bar	N/A
	Controls the horizontal position of the image within the Display area of the LCD. Range 0 to 100		
	V POSITION (VGA)	Slider bar	N/A
	Controls the vertical position of the image within the Display area of the LCD. Range 0 to 100		
	CLOCK (VGA)	Slider bar	N/A
	Adjust the width of the image. Range 0 to 100		
	PHASE (VGA)	Slider bar	N/A
	Adjusts the visual "noise" on the image. Range 0 to 63		
	WHITE BALANCE (VGA)	Press ENTER	
Perform the white balance			
SCALING (VGA, HDMI, CVBS, SDI)	ASPECT OFF	Default CUSTOM	
Adjust the image scaling setting			
	VOLUME	slider bar	Default 10
	Adjust the volume. Range 0 to 31		
Turn the mute ON / OFF			
	PIP SOURCE	VGA/ HDMI CVBS1/ CBVS2/ SDI	N/A
	Select the PIP source from the input signal		
	PIP Mode	OFF/ PIP/ POP SIDE BY SIDE ASPECT SIDE BY SIDE FULL	Default OFF
	Select the PIP Mode of display		
	PIP SIZE	SMALL MIDDLE LARGE	Default SMALL
Configure the PIP display size.			
PIP POSITION	H POSITION slider bar V POSITION slider bar	Default 100	
Controls the horizontal / vertical position of the PIP image Range 0 to 100			

OSD Icon	Sub-menu	Settings	Note
 OSD	OSD TURN OFF	slider bar	Default 10
	Turns off the OSD after a period of inactivity. The preset choices are 0-60 seconds.		
	OSD POSITION	H POSITION slider bar V POSITION slider bar	Default 50
	Determines the location where the OSD appears on the screen. Range 0 to 100		
	MONITOR INFORMATION	N/A	
	Show BIOS version & resolution info.		
	OSD TRANSPARENCY	OFF TYPE1 TYPE2	Default OFF
Select the transparency level of OSD			
 ADVANCED	INPUT DETECT	NONE AUTO DETECT	Default mode
	Configure the input detect function yes or not		
	CHANNEL SELECT	VGA HDMI CVBS1 CBVS2 SDI	
	Switch the setting of signal input		
	SCAN MODE	OVER SCAN UNDER SCAN	Default OVER SCAN
	Select the Scan mode		
	BRIGHTNESS MIN	slider bar	Default 10
	Setting the Minimum of the brightness. Range 0 to 10		
	FACTORY RESET	YES / NO	Default No
Resets OSD options back to factory settings			

3.3 Troubleshooting Guide

If your monitor fails to operate correctly, check the following chart for possible solution before calling for repairs:

Condition	Check Point
The picture does not appear	<ul style="list-style-type: none"> • Check if the signal cable is firmly seated in the socket. • Check if the Power is ON at the computer • Check if the brightness control is at the appropriate position, not at the minimum.
The screen is not synchronized	<ul style="list-style-type: none"> • Check if the signal cable is firmly seated in the socket. • Check if the output level matches the input level of your computer. • Make sure the signal timings of the computer system are within the specification of the monitor. • If your computer was working with a CRT monitor, you should check the current signal timing and turn off your computer before you connect the VGA Cable to this monitor.
The position of the screen is not in the center	<ul style="list-style-type: none"> • Adjust the H-position, and V-position, or Perform the Auto adjustment.
The screen is too bright (too dark)	<ul style="list-style-type: none"> • Check if the brightness or contrast control is at the appropriate position, not at the Maximum (Minimum).
The screen is shaking or waving	<ul style="list-style-type: none"> • Perform the Auto adjustment. • Moving all objects which emit a magnetic field such as motor or transformer, away from the monitor. • Check if the specific voltage is applied. • Check if the signal timing of the computer system is within the specification of monitor.

**If you are unable to correct the fault by using this chart, stop using your monitor and contact your distributor or dealer for further assistance.*

Appendix

This chapter contains additional product information, including troubleshooting guide and frequency table



Appendix A: Frequency Table

The choice of supported modes depends on the monitor native resolution.

Separate RGB Video Signal (VGA) Input Timing

No.	Resolution	Frequency (Hz)	Note
1	640x480	67	MAC
2	640x480	72	VESA
3	640x480	75	VESA
4	640x480	80	VESA
5	720x400	70	IBM
6	800x600	56	VESA
7	800x600	60	VESA
8	800x600	72	VESA
9	800x600	75	VESA
10	1024x768	60	VESA
11	1024x768	70	VESA
12	1024x768	72	IBM
13	1024x768	75	VESA
14	1024x768	75	MAC
15	1280x1024	60	VESA
16	1280x1024	75	VESA
17*	1366x768	60	VESA
18*	1600x1200	60	VESA
19*	1680x1050	60	VESA
20*	1920x1080	60	VESA

Composite Video Input; Y/C Video input

Video Format	Resolution	Frequency	Country Support
NTSC	480i	60 Hz	U.S., Mexico, Japan, many others
PAL	576i	50 Hz	China, Germany, many others

HDMI 1.3

No	Resolution	Frequency
1	800x600	60 Hz
2	1024x768	60 Hz
3	1280x1024	60 Hz
4	1600x1200	60 Hz
5	1680x1050	60 Hz
6	1920x1080	60 Hz

SDI

No	Resolution	Frequency
1	720p	50Hz, 60 Hz
2	1080i	50Hz, 60 Hz
3	1080p	50Hz, 60 Hz
4	480i	60 Hz
5	576i	50 Hz

Winmate Inc.
9F, No.111-6, Shing-De Rd., San-Chung District,
New Taipei City 24158, Taiwan, R.O.C
www.winmate.com