

MT8121/8150XE series

Installation Instruction

Для заказов: +7(499)707-11-20, Email: i@sp-t.ru
8-800-511-65-88(Бесплатно по РФ)

1 Installation and Startup Guide

This document covers the installation of MT8121/8150XE Series HMI, for the detailed specifications and operation, please refer to Brochure and EasyBuilder Pro User Manual.

Install Environment:

NEMA Rating	MT8121/8150XE Series HMI is NEMA 4 rated.
Electrical Environment	The MT8121/8150XE Series has been tested to conform to European CE requirements. This means that the circuitry is designed to resist the effects of electrical noise. This does not guarantee noise immunity in severe cases. Proper wire routing and grounding will insure proper operation.
Environmental Considerations	<ol style="list-style-type: none"> (1) Make sure that the displays are installed correctly and that the operating limits are followed. Avoid installing units in environments where severe mechanical vibration or shocks are present. (2) Do not operate the unit in areas subject to explosion hazards due to flammable gases, vapors or dusts. (3) Do not install the unit where acid gas, such as SO₂ exists. (4) This device should be mounted in the vertical position and for use on the flat surface enclosure. (5) Conform to UL508 (ISBN 0-7629-0404-6) machine safety for use in Pollution Degree 2 Environment.

2 Unpacking the Unit

Unpack and check the delivery. If damage is found, notify the supplier.

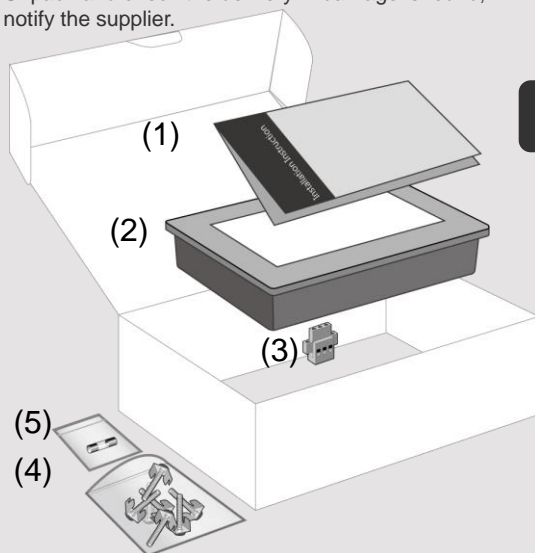

(1) Installation Instruction, 2-sided A4 *1

(2) Human Machine Interface *1

(3) Power Connector *1

(4) Brackets & Screws *1 pack

(5) Fuse 1.6A/250V 5*20mm *1

NOTE:

Place the operator panel on a stable surface during installation. Dropping it or letting it fall may cause damage.

3 Installation Instructions

Secure the operator panel in position, using all the fastening holes and the provided brackets and screws:

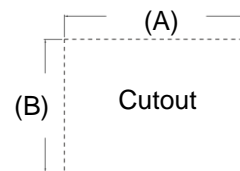

Type	A(mm)	B(mm)
MT8121XE	305	231
MT8150XE	352	279

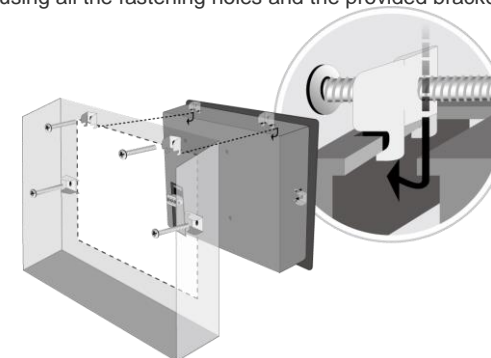

4 Power Connections

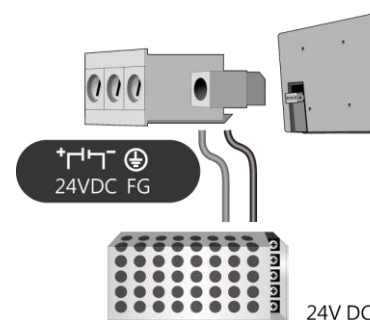

NOTE:

1. Connect positive DC line to the '+' terminal and the DC ground to the '-' terminal.

2. Please do not connect HMI with PLC and PC simultaneously to prevent potential difference from destroying USB ports of HMI and PC.

5 System Settings

When HMI powered up and displays image, press the system setting button. (Default System Password: 111111) It is necessary to connect the HMI to your network through a RJ-45 cable.

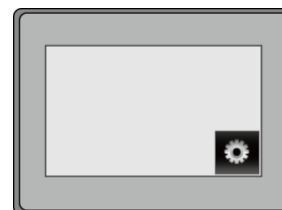

Go to the Network tab, you may choose to auto get DHCP IP, or designate your own IP.

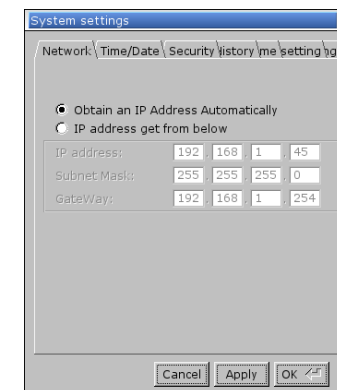

6 EasyBuilder Pro Software Settings

Please use EasyBuilder Pro ver. 4.00.01 or later versions.

Launch EasyBuilder Pro software, select your project file, press F7 shortcut key to open the download dialog box: Select Ethernet > IP tab > Enter your HMI IP > Click Download to download this project file to HMI.

(Please refer to EasyBuilder Pro User Manual for software operation details)

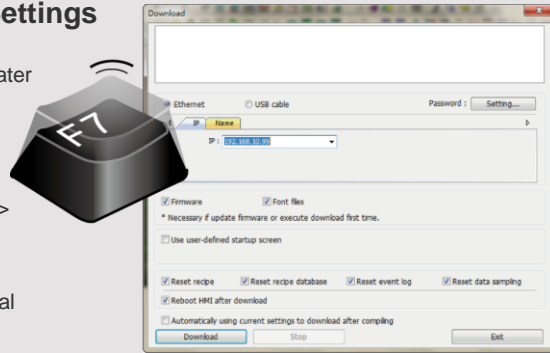

7 Communication Connections

NOTE:

1. COM1 and COM3 [RS485] 2W support MPI 187.5K, please use one at one time.
2. COM1 [RS485] / COM3 [RS485] with isolation protection.

COM1 [RS232] 9 Pin, Male, D-sub

1 2 3 4 5
6 7 8 9

PIN#	Symbol	COM1 [RS232]
1	Not used	
2	RxD	Received Data
3	TxD	Transmitted Data
4	Not used	
5	GND	Signal Ground
6	Not used	
7	RTS	Ready to send output
8	CTS	Clear to send input
9	Not used	

COM1 / COM3 [RS485] 9 Pin, Female, D-sub

5 4 3 2 1
9 8 7 6

PIN#	Symbol	COM1 [RS485]		COM3 [RS485]
		2W	4W	
1	Rx-	Data-	Rx-	
2	Rx+	Data+	Rx+	
3	Tx-		Tx-	
4	Tx+		Tx+	
5	GND1	Ground1		
6	Not used			
7	Data-			Data-
8	Data+			Data+
9	GND2			Ground2

8 Calibration Mode

1. When HMI powered up and displays image, press the calibration mode button.
2. Click [Yes] in the "Continue to touch panel calibration?" dialog box.
3. A "+" sign appears on the screen, touch the center of the sign, after all signs are touched, "+" sign disappears. At this point the calibration is finished, and it returns to the project.



CAUTION

NOTE: Make sure that all local and national electrical standards are met when installing the unit. Contact your local authorities to determine which codes apply.



Power

The HMI can be powered by DC power only, voltage range: 24±20% Volts DC, compatible with most controller DC systems. The power conditioning circuitry inside the unit is accomplished by a switching power supply. The peak starting current can be as high as 2A.

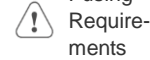

Fusing Requirements

If the display does not come on within 5 seconds of power up, remove power. An internal fuse will prevent damage if the polarity of the DC power is incorrect. Check wiring for proper connections and try to power up again.



High Voltage

An Internal fuse will prevent damage for overcurrent condition however it isn't guaranteed. DC voltage sources should provide proper isolation from main AC power and similar hazards.

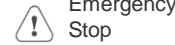

Emergency Stop

A Hard-wired EMERGENCY STOP should be fitted in any system using HMI to comply with ICS Safety Recommendations.



Supply Voltage Condition

Do not power the HMI and inductive DC loads, or input circuitry to the controller, with the same power supply. Note: The 24 VDC output from some controllers may not have enough current to power the HMI.



Wire Routing

- a. Power wire length should be minimized (Max: 500m shielded, 300m unshielded).
- b. Please use twisted pair cables for power wire and signal wire and conform to the impedance matching.
- c. If wiring is to be exposed to lightning or surges, use appropriate surge suppression devices.
- d. Keep AC, high energy, and rapidly switching DC power wiring separated from signal wires.
- e. Add a resistor and capacitor in the parallel connection between the ungrounded DC power supply and the frame ground. This provides a path for static and high frequency dissipation. Typical values to use are 1M Ohm and 4700pF.

DANGER

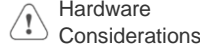

Hardware Considerations

The system designer should be aware that devices in Controller systems could fail and thereby create an unsafe condition. Furthermore, electrical interference in an operator interface can lead to equipment start-up, which could result in property damage and/or physical injury to the operator. If you use any programmable control systems that require an operator, be aware that this potential safety hazard exists and take appropriate precautions. Although the specific design steps depend on your particular application, the following precautions generally apply to installation of solid-state programmable control devices, and conform to the guidelines for installation of Controllers recommended in NEMA ICS 3-304 Control Standards.



Programming Considerations

To conform with ICS Safety Recommendations, checks should be placed in the controller to ensure that all writable registers that control critical parts of plant or machinery have limit checks built into the program, with an out-of-limit safe shut down procedure to ensure safety of personnel.

GME810XE0_MT8121_8150XE_Installation_131024

Limited Warranty

This product is limited warranted against defects in design and manufacture. The proven defective product will either be repaired or replaced, at Weintek's discretion. This warranty shall not cover any product which is

- (a) Out of warranty period which is 12 months from the manufacturing month of the HMI products.
- (b) Damage caused by Force Majeure, accident, negligence, improper installation or misuse.
- (c) Product has been repaired or taken apart by unauthorized technicians.
- (d) Products whose identification markings have been removed or damaged.