

cMT3072X2 cMT3072XH2 series

Installation Instruction

1 Installation and Startup Guide

This document covers the installation of cMT3072X2/3072XH2 Series HMI, for the detailed specifications and operation, please refer to Datasheet, Brochure and EasyBuilder Pro User Manual. Please read all warnings, precautions, and instructions on the device carefully before use.

Install Environment:

NEMA Rating	The HMI product is NEMA 4 rated (Indoor Only).
Electrical Environment	The HMI product has been tested to conform to European CE requirements. This means that the circuitry is designed to resist the effects of electrical noise. This does not guarantee noise immunity in severe cases. Proper wire routing and grounding will insure proper operation.
Environmental Considerations	<ol style="list-style-type: none"> (1) Make sure that the displays are installed correctly and that the operating limits are followed. Avoid installing units in environments where severe mechanical vibration or shocks are present. (2) Do not operate the unit in areas subject to explosion hazards due to flammable gases, vapors or dusts. (3) Do not install the unit where acid gas, such as SO₂ exists. (4) This device should be mounted in the vertical position and for use on the flat surface enclosure. (5) For use in Pollution Degree 2 Environment and dry location. (6) Relative Humidity: 10% ~ 90% (non-condensing)
Cleaning Considerations	Clean the device using dry cloths. Do not use liquid or spray detergents for cleaning.
IP Rating	IP 66
 Warning	Protection impairment if used in a manner not specified by the manufacturer. Déficit de protection si utilisé d'une manière non spécifiée par le fabricant.

2 Unpacking the Unit

Unpack and check the delivery. If damage is found, please contact the supplier.

NOTE: Place the operator panel on a stable surface during installation. Dropping it or letting it fall may cause damage.

The package includes:

- (1) Installation Instruction, 2-sided A4 *1
- (2) Human Machine Interface *1
- (3) Power Connector *1
- (4) Brackets & Screws *1 pack
- (5) USB Stick Clamp & Tying Strap *1

USB Stick Clamp Usage

Combining the USB Stick with the clamp and the tying strap can prevent USB stick from disconnecting with HMI when strong vibration is present.

1. Insert the USB connector to the clamp and tie them together with the tying strap.
2. Press the spring and insert the USB stick into HMI.

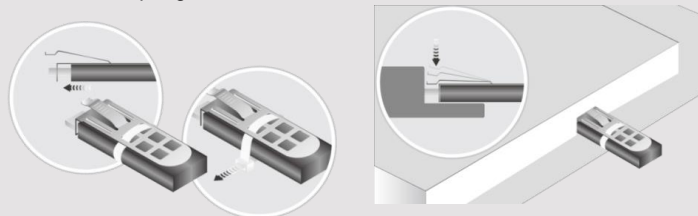

3 Installation Instructions

Use a control box that provides enough stiffness. Cutout Dimension: 192 mm x 138 mm. Secure the operator panel in position, using all the fastening holes and the provided brackets and screws. Screw Torque: 2.6 ~ 3.9 lbf.in. (For reaching waterproof effect and preventing the panel from being deformed.)

Plan for adequate space around the unit and inside the enclosure, for ventilation and cables. Consider the heat from other devices inside the enclosure. The ambient temperature around the unit must be 0 ~ 55°C

Minimum required clearances (along the overlay): Top / Bottom / Sides 15 mm

Maximum panel thickness: 4.5 mm

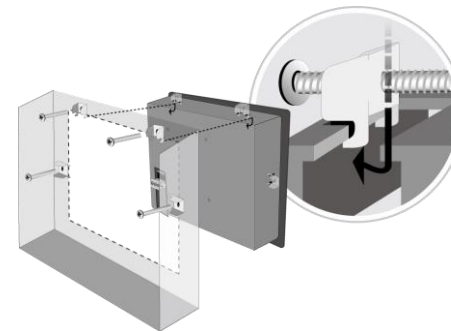

4 Power Connections

Power Connector Specifications:

Wire AWG: 24~12

Wiring Conductor Minimum Temperature: 75°C

Screw Torque: 4.5 lbf-in (max.)

Copper conduct only.

Spécifications du connecteur d'alimentation:

AWG de fil: 24 ~ 12

Température minimale du conducteur de câblage: 75°C

Couple de vis: 4.5 lbf-in (max.)

Conducteur en cuivre seulement

NOTE:

1. Connect positive DC line to the '+' terminal and the DC ground to the '-' terminal.

2. When downloading project using a USB cable, do not connect HMI with PLC and PC simultaneously, for electric potential difference may result in damage to HMI or PC.

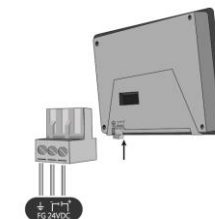

5 System Settings

When HMI is powered up and displays image, press the round Start Button in the upper-left corner of the screen to open the Setting dialog box. Tap the lock icon  and log in. (Default System Password: 111111)

Go to the Network tab, and setup your network.

In Setting dialog box you can see device information, configure general settings, set HMI Time/Date/Name, and more.

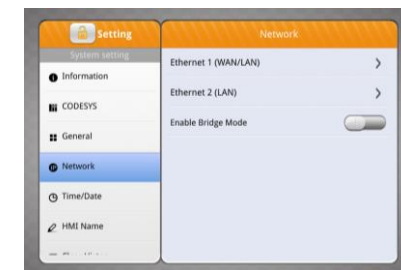

6 EasyBuilder Pro Software Settings

Launch EasyBuilder Pro software, select your project file,

press F7 shortcut key to open the download dialog box: Select Ethernet > IP tab > Enter your HMI IP > Click Download to download this project file to HMI.

Using screensaver and backlight saver is recommended in order to avoid image persistence caused by displaying the same image on HMI for a long time.

(Please refer to EasyBuilder Pro User Manual for software operation details.)

7 Communication Connections

NOTE:

- COM2 and COM3 [RS485] 2W support MPI 187.5K, please use one at a time. (cMT3072XH2)
- Only Tx & Rx (no RTS/CTS) may be used for COM1 RS232 when COM3 RS-232 is also used.

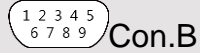

COM1/COM3 [RS232] 9 Pin, Male, D-sub

PIN#	COM1 [RS232]4W	COM3 [RS232]2W
1		
2	RxD	
3	TxD	
4		
5	GND	
6		
7	RTS	TxD
8	CTS	RxD
9	GND	

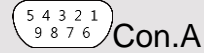

COM2/COM3 [RS485]/CAN Bus 9 Pin, Female, D-sub

PIN#	COM2 [RS485]2W	COM2 [RS485]4W	COM3 [RS485]2W	CAN Bus
1	Data-	Rx-		
2	Data+	Rx+		
3		Tx-		
4		Tx+		
5	GND			
6			Data-	
7				CAN_L
8				CAN_H
9			Data+	

8 Touchscreen Calibration & Restore Factory Default

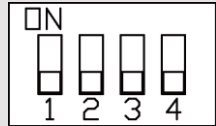

SW1	SW2	SW3	SW4	Mode
ON	OFF	OFF	OFF	Touch Screen Calibration Mode & Reset HMI to Default
OFF	ON	OFF	OFF	Hide Start Button
OFF	OFF	ON	OFF	Update OS
OFF	OFF	OFF	ON	Reserved
OFF	OFF	OFF	OFF	Normal

Restore Factory Default:

Follow Step 5 to open the Setting dialog box. After login, press the button of "Reset HMI to default". Another way to restore factory default is entering "default111111" when logging in. An Attention window shows, enter "yes". Please note that the projects and data stored in the unit are all cleared after restoring factory default. Another way to enter touch screen calibration mode: Press and hold anywhere on the screen until HMI starts.

9 Battery Replacement

Battery Specification: Type CR2032, Rated 3V

Battery replacement shall be performed by qualified personnel (engineer) only and care must be taken when handling lithium batteries. For more information on battery replacement and disposal considerations, please refer to the following link:

http://www.weintek.com/download/MT8000/eng/FAQ/FAQ_103_Replace_Battery_en.pdf

CAUTION



Power

NOTE: Make sure that all local and national electrical standards are met when installing the unit. Contact your local authorities to determine which codes apply.

Use power output that meets SELV (Safety Extra-Low Voltage) requirements. The unit can be powered by DC power only, voltage range: 24±20%, compatible with most controller DC systems. The power conditioning circuitry inside the unit is accomplished by a switching power supply. The peak starting current can be as high as 2A.



Fusing Requirements

If the display does not come on within 5 seconds of power up, remove power. A resettable fuse will protect against overcurrent faults in DC circuit and the resetting will take place after a period of time. Check wiring for proper connections and try to power up again.



High Voltage

A resettable fuse will prevent damage for overcurrent condition however it isn't guaranteed. DC voltage sources should provide proper isolation from main AC power and similar hazards



Emergency Stop

A Hard-wired EMERGENCY STOP should be fitted in any system using an HMI to comply with ICS Safety Recommendations.



Supply Voltage Condition

Do not power the unit and inductive DC loads, or input circuitry to the controller, with the same power supply. Note: The 24 VDC output from some controllers may not have enough current to power the unit.

- Power wire length should be minimized (Max: 500m shielded, 300m unshielded).
- Please use twisted pair cables for power wire and signal wire and conform to the impedance matching.
- If wiring is to be exposed to lightning or surges, use appropriate surge suppression devices.
- Keep AC, high energy, and rapidly switching DC power wiring separated from signal wires.
- Add a resistor and capacitor in the parallel connection between the ungrounded DC power supply and the frame ground. This provides a path for static and high frequency dissipation. Typical values to use are 1M Ohm and 4700pF.



Wire Routing

DANGER



Hardware Considerations

The system designer should be aware that devices in Controller systems could fail and thereby create an unsafe condition. Furthermore, electrical interference in an operator interface can lead to equipment start-up, which could result in property damage and/or physical injury to the operator.

If you use any programmable control systems that require an operator, be aware that this potential safety hazard exists and take appropriate precautions. Although the specific design steps depend on your particular application, the following precautions generally apply to installation of solid-state programmable control devices, and conform to the guidelines for installation of Controllers recommended in NEMA ICS 3-304 Control Standards.



Programming Considerations

To conform to ICS Safety Recommendations, checks should be placed in the controller to ensure that all writable registers that control critical parts of plant or machinery have limit checks built into the program, with an out-of-limit safe shut down procedure to ensure safety of personnel.

GMEC72X20_cMT3072X2/XH2_Installation_220530

Limited Warranty

This product is limited warranted against defects in design and manufacture. The proven defective product will either be repaired or replaced, at Weintek's discretion. This warranty shall not cover any product which is

- Out of warranty period which is 12 months from the manufacturing month of the HMI products.
- Damage caused by Force Majeure, accident, negligence, improper installation or misuse.
- Product has been repaired or taken apart by unauthorized technicians.
- Products whose identification markings have been removed or damaged.