

R3000

Hardware Manual

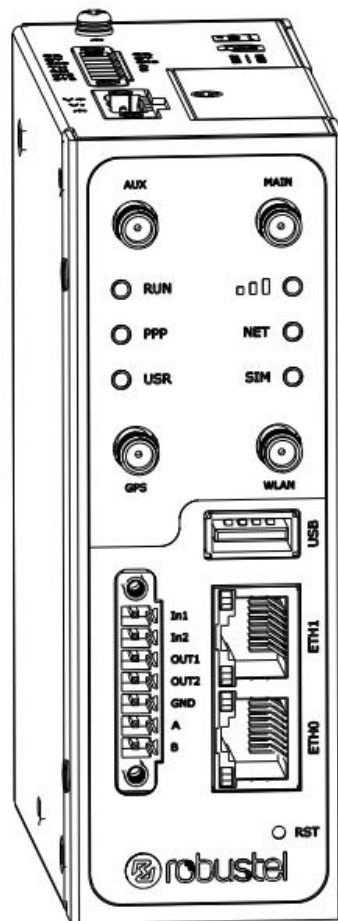

Version: 1.0.2

Date: July 14, 2023

Regulatory and Type Approval Information

Table 1: Toxic or Hazardous Substances or Elements with Defined Concentration Limits

Name of the Part	Hazardous Substances									
	(Pb)	(Hg)	(Cd)	(Cr(VI))	(PBB)	(PBDE)	(DEHP)	(BBP)	(DBP)	(DIBP)
Metal parts	o	o	o	o	-	-	-	-	-	-
Circuit modules	o	o	o	o	o	o	o	o	o	o
Cables and cable assemblies	o	o	o	o	o	o	o	o	o	o
Plastic and polymeric parts	o	o	o	o	o	o	o	o	o	o

o:
Indicates that this toxic or hazardous substance contained in all of the homogeneous materials for this part is below the limit requirement in RoHS2.0.

X:
Indicates that this toxic or hazardous substance contained in at least one of the homogeneous materials for this part *might exceed* the limit requirement in RoHS2.0.

-:
Indicates that it does not contain the toxic or hazardous substance.

Radio Specifications for Europe

RF technologies	2G, 3G, 4G, Wi-Fi*, GNSS*
Cellular Frequency*	4G: LTE FDD: B1/B2/B3/B4/B5/B7/B8/B12/B13/B18/B19/B20/B25/B26/B28 LTE TDD: B38/B39/B40/B41 3G: WCDMA: B1/B2/B4/B5/B6/B8/B19 2G: GSM: B2/B3/B5/B8
Wi-Fi Frequency	2.4 GHz: 2.412 ~ 2.484 GHz 5 GHz: 4.910 ~ 5.825 GHz
Max RF power	33 dBm±2dB@GSM, 24 dBm+1/-3dB@WCDMA, 23 dBm±2dB@LTE, 18 dBm@Wi-Fi

* **May vary on difference models.**

Note: The 5150 to 5350 MHz frequency range is restricted to indoor use only in.

電波法の規定により 5GHz 帯は屋内使用に限ります。

	AT	BE	BG	CH	CY	CZ	DE	DK
	EE	EL	ES	FI	FR	HR	HU	IE
	IS	IT	LI	LT	LU	LV	MT	NL
	NO	PL	PT	RO	SE	SI	SK	UK

Caution: The user is cautioned that changes or modifications not expressly approved by the party responsible for compliance could void the user's authority to operate the equipment.

This device contains licence-exempt transmitter(s)/receiver(s) that comply with Innovation, Science and Economic Development Canada's licence-exempt RSS(s) and Part 15 of the FCC Rules. Operation is subject to the following two conditions:

- (1) This device may not cause interference.
- (2) This device must accept any interference, including interference that may cause undesired operation of the device.

L'émetteur/récepteur exempt de licence contenu dans le présent appareil est conforme aux CNR d'Innovation, Sciences et Développement économique Canada applicables aux appareils radio exempts de licence. L'exploitation est autorisée aux deux conditions suivantes :

- (1) L'appareil ne doit pas produire de brouillage;
- (2) L'appareil doit accepter tout brouillage radioélectrique subi, même si le brouillage est susceptible d'en compromettre le fonctionnement.

Note: This equipment has been tested and found to comply with the limits for a Class B digital device, pursuant to Part 15 of the FCC Rules. These limits are designed to provide reasonable protection against harmful interference in a residential installation. This equipment generates, uses and can radiate radio frequency energy and, if not installed and used in accordance with the instructions, may cause harmful interference to radio communications. However, there is no guarantee that interference will not occur in a particular installation.

If this equipment does cause harmful interference to radio or television reception, which can be determined by turning the equipment off and on, the user is encouraged to try to correct the interference by one or more of the following measures:

- Reorient or relocate the receiving antenna.
- Increase the separation between the equipment and receiver.
- Connect the equipment into an outlet on a circuit different from that to which the receiver is connected.
- Consult the dealer or an experienced radio/TV technician for help.

FCC& IC Radiation Exposure Statement

This equipment complies with FCC and Canada radiation exposure limits set forth for an uncontrolled environment. This equipment should be installed and operated with a minimum distance of 20cm between the radiator and your body.

This transmitter must not be co-located or operating in conjunction with any other antenna or transmitter.

Déclaration d'IC sur l'exposition aux radiations

Cet équipement est conforme aux limites d'exposition aux radiations définies par le Canada pour des environnements non contrôlés. Cet équipement doit être installé et utilisé à une distance minimum de 20 cm entre l'antenne et votre corps.

Cet émetteur ne doit pas être installé au même endroit ni utilisé avec une autre antenne ou un autre émetteur.

Simplified EU & UK Declaration of Conformity

We, Guangzhou Robustel Co., Ltd. are located at 501, Building #2, 63 Yongan Road, Huangpu District, Guangzhou, China, declare that this radio equipment complies with EU Radio Equipment Directive (RED) 2014/53/EU, Low Voltage Directive (LVD) 2014/35/EU, EMC Directive 2014/30/EU, UK Radio Equipment Regulations 2017, EMC Regulations 2016, Electrical Equipment (Safety) Regulations 2016. The full text of the EU& UK DoC is available at the following internet address:

www.robustel.com/certifications/

Safety Information

General

- The router generates radio frequency (RF) power. When using the router, care must be taken on safety issues related to RF interference as well as regulations of RF equipment.
- Do not use your router in aircraft, hospitals, petrol stations or in places where using cellular products is prohibited.
- Be sure that the router will not be interfering with nearby equipment. For example: pacemakers or medical equipment. The antenna of the router should be away from computers, office equipment, home appliance, etc.
- An external antenna must be connected to the router for proper operation. Only uses approved antenna with the router. Please contact authorized distributor on finding an approved antenna.

RF Exposure

- This device meets the official requirements for exposure to radio waves. This device is designed and manufactured not to exceed the emission limits for exposure to radio frequency (RF) energy set by authorized agencies.
- The device must be used with a minimum separation of 20 cm from a person's body to ensure compliance with RF exposure guidelines. Failure to observe these instructions could result in your RF exposure exceeding the applicable limits.

Note: Some airlines may permit the use of cellular phones while the aircraft is on the ground and the door is open. Router may be used at this time.



The symbol indicates that the product should not be mixed with general household waste but must be sent to separate collection facilities for recovery and recycling.



The symbol indicates that the product meets the requirements of the applicable EU directives.



The symbol indicates that the product meets the requirements of the relevant UK legislation.

Related download link

Find more product documents or tools at:

www.robustel.com/en/documentations/

Technical Support

Tel: +86-20-82321505

Email: support@robustel.com

Web: www.robustel.com

Document History

Updates between document versions are cumulative. Therefore, the latest document version contains all updates made to previous versions.







Date	Firmware Version	Document Version	Change Description
Aug. 15, 2022	5.0.0	1.0.0	Initial release.
Nov. 22, 2022	5.0.0	1.0.1	Added declaration for product.
July 14, 2023	5.0.0	1.0.2	Modified declaration for product.

Overview

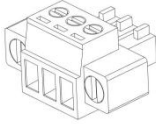
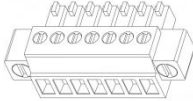
The Robustel Industrial Dual SIM Cellular VPN Router (R3000) is a rugged cellular router offering state-of-the-art mobile connectivity for machine to machine (M2M) applications.

Package Checklist

Before commencing installation ensure your package has the following components:

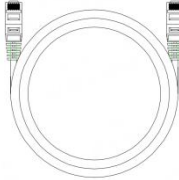
<p>Device</p> 	<p>3-PIN Terminal Block</p> 	<p>7-PIN Terminal Block</p> 	<p>RCMS Card</p> 	<p>Quick Start Guide Card</p> 
<p>Cellular Antenna (Optional)</p> 	<p>Wi-Fi Antenna (Optional)</p> 	<p>Mounting Kit (Optional)</p> 	<p>Power Supply (Optional)</p> 	<p>Ethernet Cable (Optional)</p> 

Note: The accessories could be different on specific order.

Panel Layout(May Vary on Different Models)

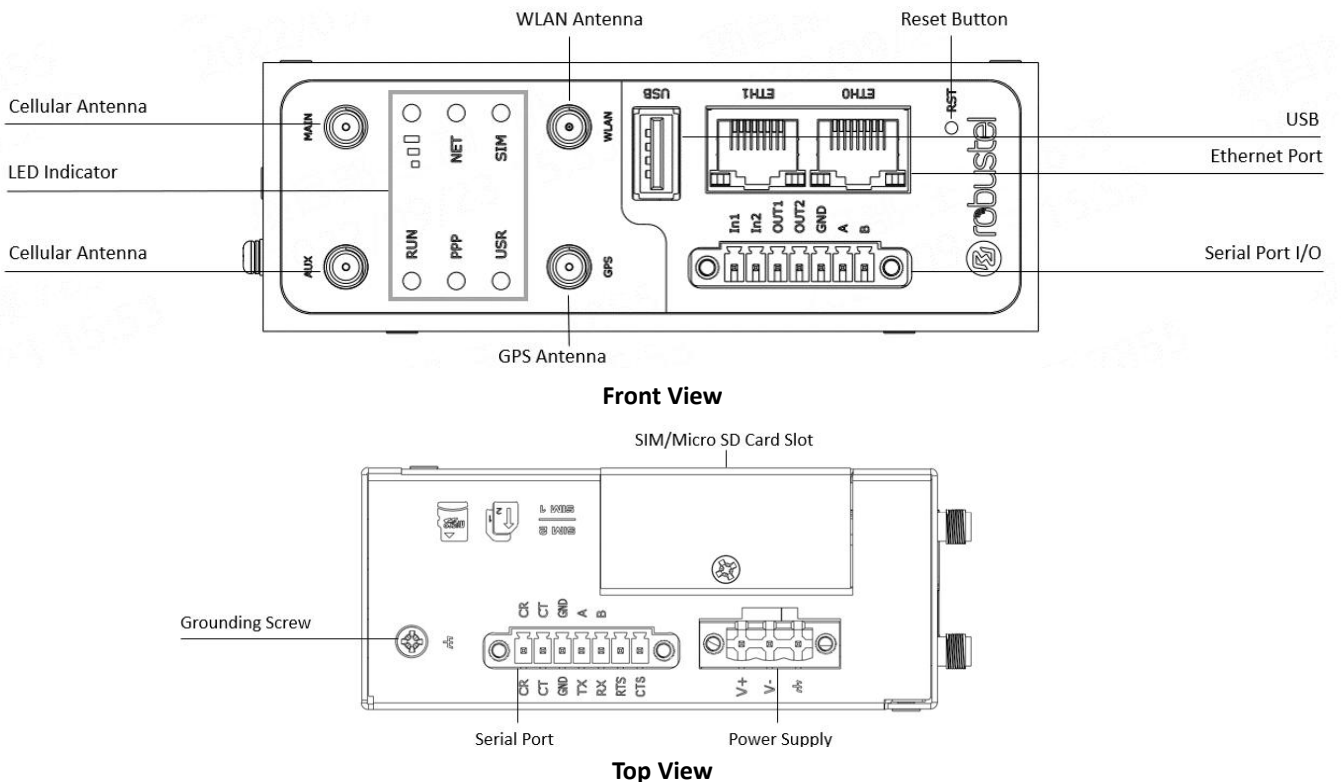

Interface Descriptions

1. PIN Assignment

Note: RS-232/RS-485 depends on the equipment hardware selection, please set according to the actual situation of the equipment.

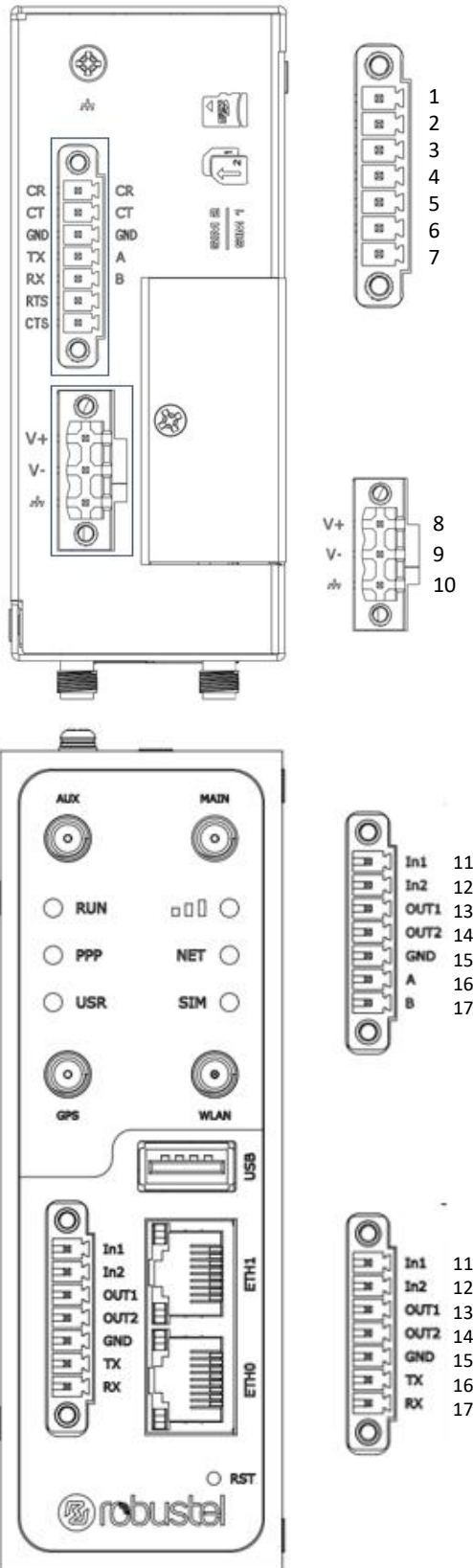

PIN	Debug	RS-232	Direction
1	CR	--	R3000 ← Device
2	CT	--	R3000 → Device
3	GND	GND	--
4	--	TXD	R3000 → Device
5	--	RXD	R3000 ← Device
6	--	RTS	R3000 → Device
7	--	CTS	R3000 ← Device

Note: When the device is configured as 2*RS-485, the pin is defined as follows:

PIN	Debug	RS-485	Direction
4	--	Data+(A)	R3000 → Device
5	--	Data- (B)	R3000 ← Device

PIN	Power
8	Positive
9	Negative
10	GND

PIN	DI/DO	RS-485	Direction
11	Input 1	--	R3000 ← Device
12	Input 2	--	R3000 ← Device
13	Output 1	--	R3000 → Device
14	Output 2	--	R3000 → Device
15	GND	--	--
16	--	Data+(A)	R3000 → Device
17	--	Data- (B)	R3000 ← Device

PIN	DI/DO	RS-232	Direction
11	Input 1	--	R3000 ← Device
12	Input 2	--	R3000 ← Device
13	Output 1	--	R3000 → Device
14	Output 2	--	R3000 → Device
15	IO_GND	--	--
16	--	TXD	R3000 → Device
17	--	RXD	R3000 ← Device
3	--	GND	--

Note: When PIN16/PIN17 is configured as RS-232, the GND of RS-232 should be connected to PIN3.

Typical Application:

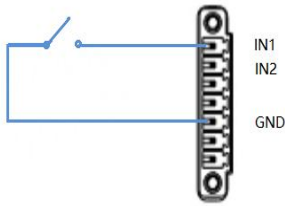

DI Connection (IN1 for example)

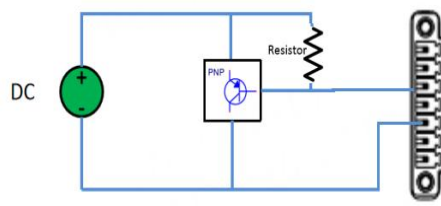

DO connect to PNP transistor(OUT1 for example)

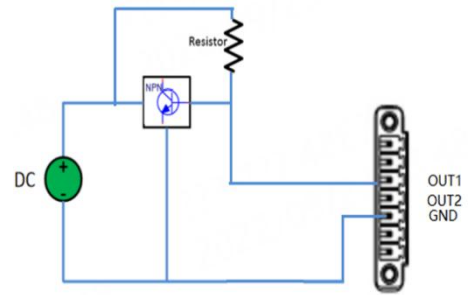

DO connect to NPN transistor(OUT1 for example)

2. LED Indicators

Name	Color	Status	Description
RUN	Green	On, fast blinking (250ms blink time)	Router is powered on (System is initializing)
		On, blinking (500ms blink time)	Router starts operating
		Off	Router is powered off
PPP	Green	On, solid	Link connection is working
		Off	Link connection is not working
USR-OpenVPN	Green	On, solid	OpenVPN connection is established
		Off	OpenVPN connection is not established
USR-IPsec	Green	On, solid	IPsec connection is established
		Off	IPsec connection is not established
USR-Wi-Fi	Green	On, solid	Wi-Fi is enabled and working properly
		Off	Wi-Fi is disabled or not working properly
	Green	On, solid	High Signal strength (21-31) is available
	Yellow	On, solid	Medium Signal strength (11-20) is available
	Red	On, solid	Low Signal strength (1-10) is available
	--	Off	No signal
NET	Green	On, solid	Connection to 4G network is established
	Yellow	On, solid	Connection to 3G network is established
	Red	On, solid	Connection to 2G network is established
	--	Off	Connection to network is not established or establishing
SIM	Green	On, solid	Main card is being used
		On, blinking	Backup card is being used
		Off	NO SIM card

Note: You can choose the display type of USR LED. For more details, please refer to **RT123_SM_RobustOS Software Manual Service > Advanced > System >System Settings > User LED Type.**

3. Reset Button

Feature	Operation
Reboot	Press and hold the RST button for 2~ 5 seconds under the operating status.
Restore to default configuration	Press and hold the RST button for 5~10 seconds, the RUN LED starts blinking quickly, the router will restore to default configuration.
Restore to factory default settings	Once the operation of restoring default configuration is performed twice within one minute, the router will restore to factory default settings.

Note: The more details please refer to *RT123_SM_RobustOS Software Manual, 2.3 Factory Reset*.

4. Ethernet Ports. There are 2 Ethernet ports on R3000 Router, including ETH0 and ETH1. Each Ethernet port has 2 LED indicators. The yellow one is a link indicator, while the green one is a speed indicator. For details about status, see the table below.

Indicator	Status	Description
Link indicator	On, solid	Connection is established
	On, blinking	Data is being transferred
	Off	Connection is not established
Speed indicator	On, solid	100 Mbps mode
	Off	10 Mbps mode

5. USB Interface

Feature	Operation
Firmware upgrade	USB interface is used for batch firmware upgrading, but cannot be used for sending or receiving data from slave devices which connected to it. You can insert a USB storage device into the router's USB interface, such as a U disk or a hard disk. If there have a supported configuration file or a router firmware in this USB storage device, the router will automatically update the configuration file or the firmware. For more details, see <i>RT123_SM_RobustOS Software Manual</i> .

Hardware Installation

1. **SIM Card Installation.** Loosen the screws associated with the cover by using a screwdriver and then find the SIM card slot/Micro SD card slot. Press the card with finger until you hear a click and then tighten the screws associated with the cover by using a screwdriver. Put back the cover and tighten the screws associated with the cover by using a screwdriver.

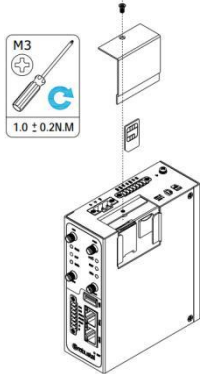

2. **Antenna Installation.** Rotate the antenna into the antenna connector accordingly.

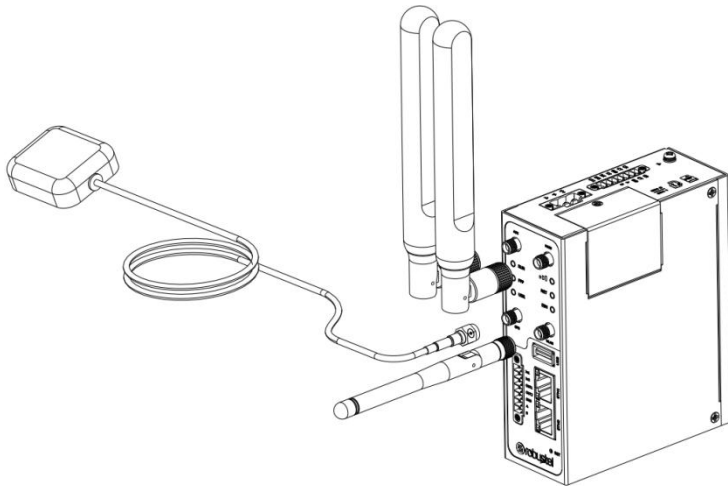

3. **Terminal Block Installation.** Insert the terminal blocks into the interfaces connector, then can connect the devices or sensors to the gateway via corresponding interfaces e.g. RS232/RS485, DIDO...

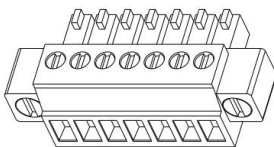

4. **Mounting Kit installation. (Optional)**

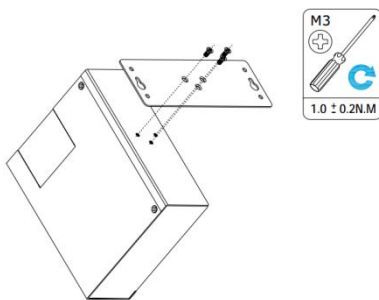

Wall mounting

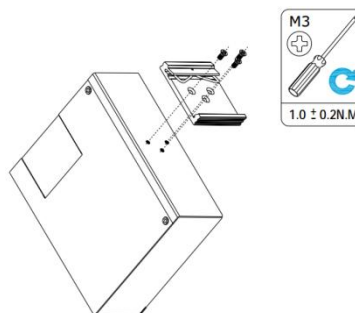

DIN rail mounting

- 5. Grounding the Device.** Grounding will help to prevent the noise effect due to electromagnetic interference (EMI). Connect the device to the site ground wire by the grounding screw before powering on.

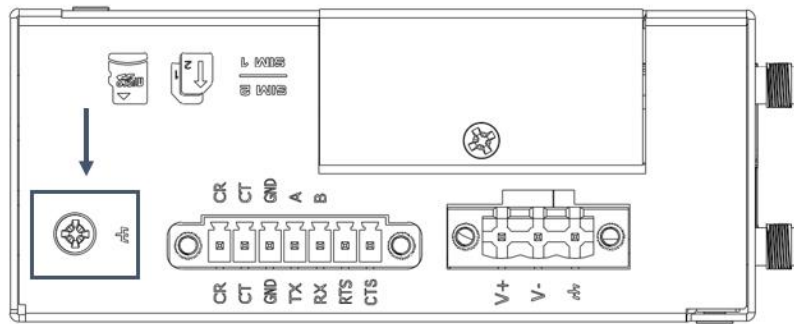

- 6. Power Supply installation.** Following to the color of the head, connect the cable marked red to the positive pole through a terminal block, and connect the yellow one to the negative in the same way. The last step is to plug the power adapter into your socket.

Note: The range of power voltage is 9 to 60V DC.

CONNECTING THE POWER CABLE

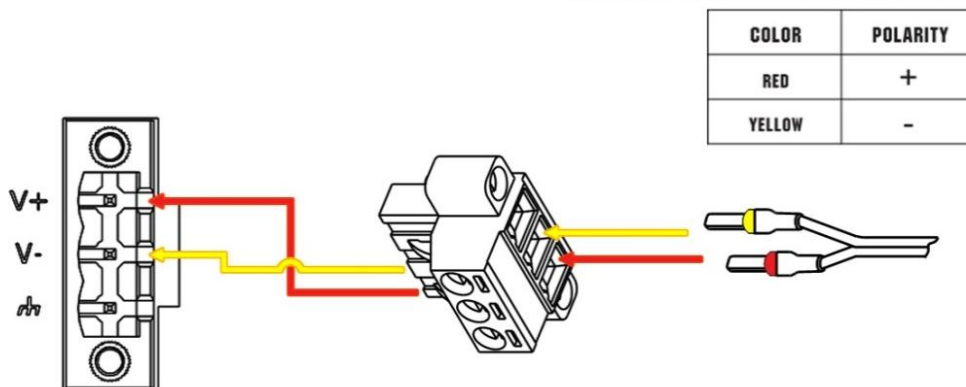

Login to the Device

1. Connect the router's Ethernet port to a PC with a standard Ethernet cable.
2. Before logging in, manually configure the PC with a static IP address on the same subnet as the gateway address, click and configure "Use the following IP address".

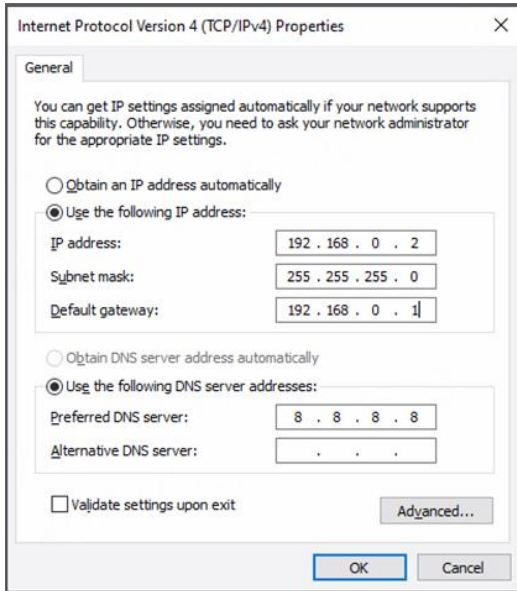

3. To enter the gateway's web interface, type <http://192.168.0.1> into the URL field of your Internet browser.
4. Use login information shown in the product label when prompted for authentication.

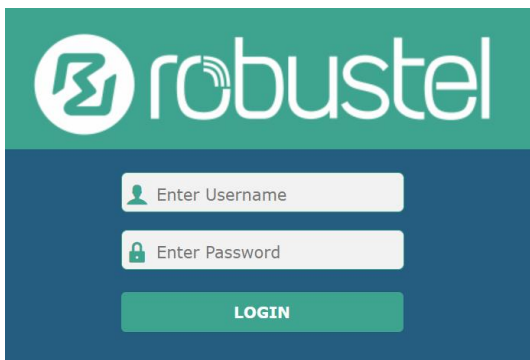

5. After logging in, the home page of the web interface is displayed, then you can view system information and perform configuration on the device.

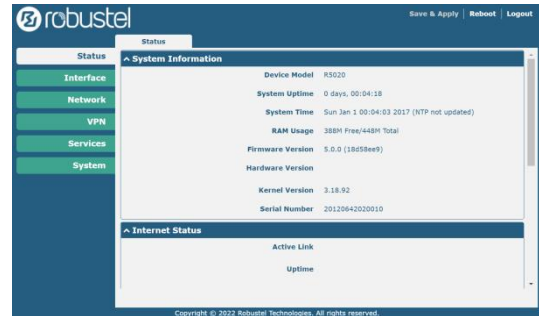

6. The automatic APN selection is ON by default, if need to specify your own APN, please go to the menu **Interface->Link Manager->Link Setting->WWAN Settings** to finish the specific setting.

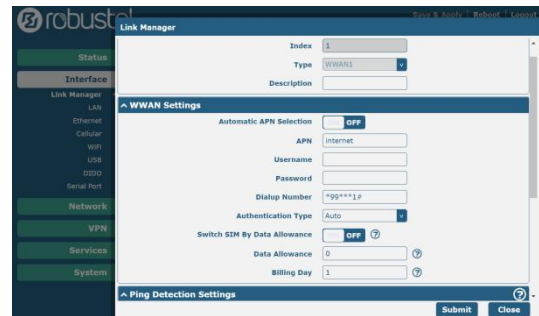

7. The more configuration details please refer to **RT123_SM_RobustOS Software Manual**.
(END)