

R3000 LG

Hardware Manual

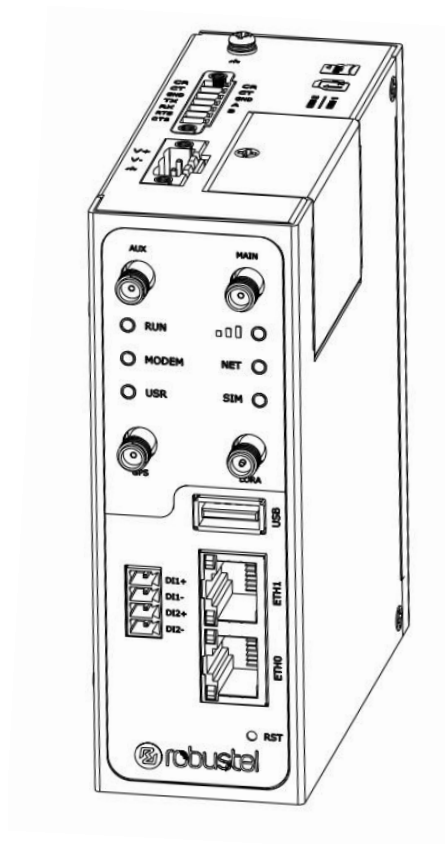

Version: 1.0.0

Date: July 28, 2022

Regulatory and Type Approval Information

Table 1: Directives



2011/65/EU	<p>The European RoHS2.0 2011/65/EU Directive was issued by the European parliament and the European Council on 1 July 2011 on the restriction of the use of certain Hazardous substances in electrical and electronic equipment.</p> <p>On June 4, 2015, the Official Journal of the European Union published the RoHS2.0 Amendment Directive (EU) In 2015/863, four phthalates (DEHP, BBP, DBP, DIBP) were officially included in the list of restricted substances in Appendix II of RoHS 2.0 (2011/65/EU). From July 22, 2019, all electronic and electrical products exported to Europe (except medical and monitoring equipment) must meet this restriction; from July 22, 2021, medical equipment and monitoring equipment will also be included in the scope of control.</p>	
2012/19/EU	<p>The European WEEE 2012/19/EU Directive was issued by the European parliament and the European Council on 24 July 2012 on waste electrical and electronic equipment.</p>	
2013/56/EU	<p>The European 2013/56/EU Directive is a battery Directive which published in the EU official gazette on 10 December 2013. The button battery used in this product conforms to the standard of 2013/56/EU directive.</p>	

Table 2: Toxic or Hazardous Substances or Elements with Defined Concentration Limits

Name of the Part	Hazardous Substances									
	(Pb)	(Hg)	(Cd)	(Cr(VI))	(PBB)	(PBDE)	(DEHP)	(BBP)	(DBP)	(DIBP)
Metal parts	o	o	o	o	-	-	-	-	-	-
Circuit modules	o	o	o	o	o	o	o	o	o	o
Cables and cable assemblies	o	o	o	o	o	o	o	o	o	o
Plastic and polymeric parts	o	o	o	o	o	o	o	o	o	o
<p>o: Indicates that this toxic or hazardous substance contained in all of the homogeneous materials for this part is below the limit requirement in RoHS2.0.</p> <p>X: Indicates that this toxic or hazardous substance contained in at least one of the homogeneous materials for this part <i>might exceed</i> the limit requirement in RoHS2.0.</p> <p>-: Indicates that it does not contain the toxic or hazardous substance.</p>										

Radio Specifications

RF technologies	2G, 3G, 4G, LoRa, GNSS*	
Cellular Frequency*	4G: LTE FDD: B1/B2/B3/B4/B5/B7/B8/B12/B13/B18/B19/B20/B25/B26/B28 LTE TDD: B38/B39/B40/B41 3G: WCDMA: B1/B2/B4/B5/B6/B8/B19 2G: GSM: B2/B3/B5/B8	EMEA, Oceania, North America
LoRa Frequency	863-870 MHz (Europe) 915-927 MHz (Australia) 902-928 MHz (North America) 920-928 MHz (Japan)	
Max RF power	35 dBm@GSM, 25 dBm@WCDMA, 25 dBm@LTE, 24.5 dBm@LoRa	

* *May vary on difference models.*

Simplified EU Declaration of Conformity

We, Guangzhou Robustel Co., Ltd. are located at 501, Building #2, 63 Yongan Road, Huangpu District, Guangzhou, China, declare that this radio equipment complies with all applicable EU directives. The full text of the EU DoC is available at the following internet address:

www.robustel.com/certifications/

FCC Declaration of Conformity

This device complies with Part 15 of the FCC Rules. Operation is subject to the following two conditions:

- (1) This device may not cause harmful interference.
- (2) This device must accept any interference received, including interference that may cause undesired operation.

IC Declaration of Conformity

This device contains licence-exempt transmitter(s)/receiver(s) that comply with Innovation, Science and Economic Development Canada's licence-exempt RSS(s). Operation is subject to the following two conditions:

- (1) This device may not cause interference.
- (2) This device must accept any interference, including interference that may cause undesired operation of the device.

L' émetteur/récepteur exempt de licence contenu dans le présent appareil est conforme aux CNR d' Innovation, Sciences et Développement économique Canada applicables aux appareils radio exempts de licence. L' exploitation est autorisée aux deux conditions suivantes :

- (1) L' appareil ne doit pas produire de brouillage;
- (2) L' appareil doit accepter tout brouillage radioélectrique subi, même si le brouillage est susceptible d' en compromettre le fonctionnement.

Radio Frequency Exposure Statement for IC

This device complies with IC exposure limits set forth for an uncontrolled environment. This device shall be installed and operated with minimum distance 20cm between the radiator & body.

Cet équipement est conforme aux limites d'exposition IC définies pour un environnement non contrôlé. Cet équipement doit être installé et utilisé avec une distance minimale de 20 cm entre le radiateur et la carrosserie.

Related download link

Find more product documents or tools at:
www.robustel.com/en/documentations/

Technical Support

Tel: +86-20-82321505

Email: support@robustel.com

Web: www.robustel.com

**Document History**

Updates between document versions are cumulative. Therefore, the latest document version contains all updates made to previous versions.





Date	Firmware Version	Document Version	Change Description
July 28, 2022	5.0.0	1.0.0	Initial release.

Overview

Robustel R3000 LG is an industrial-grade LoRaWAN gateway, integrated with LoRaWAN wireless communication technology and cellular network technology, to provide users with wireless long-distance data transmission services.

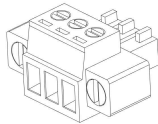
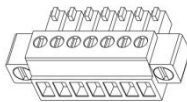
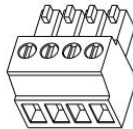
Package Checklist

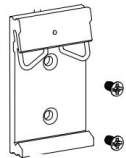
Before commencing installation ensure your package has the following components:

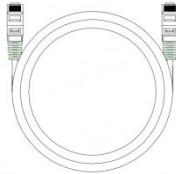
<p>Device</p> 	<p>3PIN Terminal Block</p> 	<p>7PIN Terminal Block</p> 	<p>4PIN Terminal Block</p> 	<p>RCMS Card</p> 
<p>Quick Start Guide Card</p> 	<p>Mounting Kit (Optional)</p> 	<p>Cellular Antenna (Optional)</p> 	<p>Power Supply (Optional)</p> 	<p>Ethernet Cable (Optional)</p> 

Note: The accessories could be different on specific order.

Panel Layout(May Vary on Different Models)

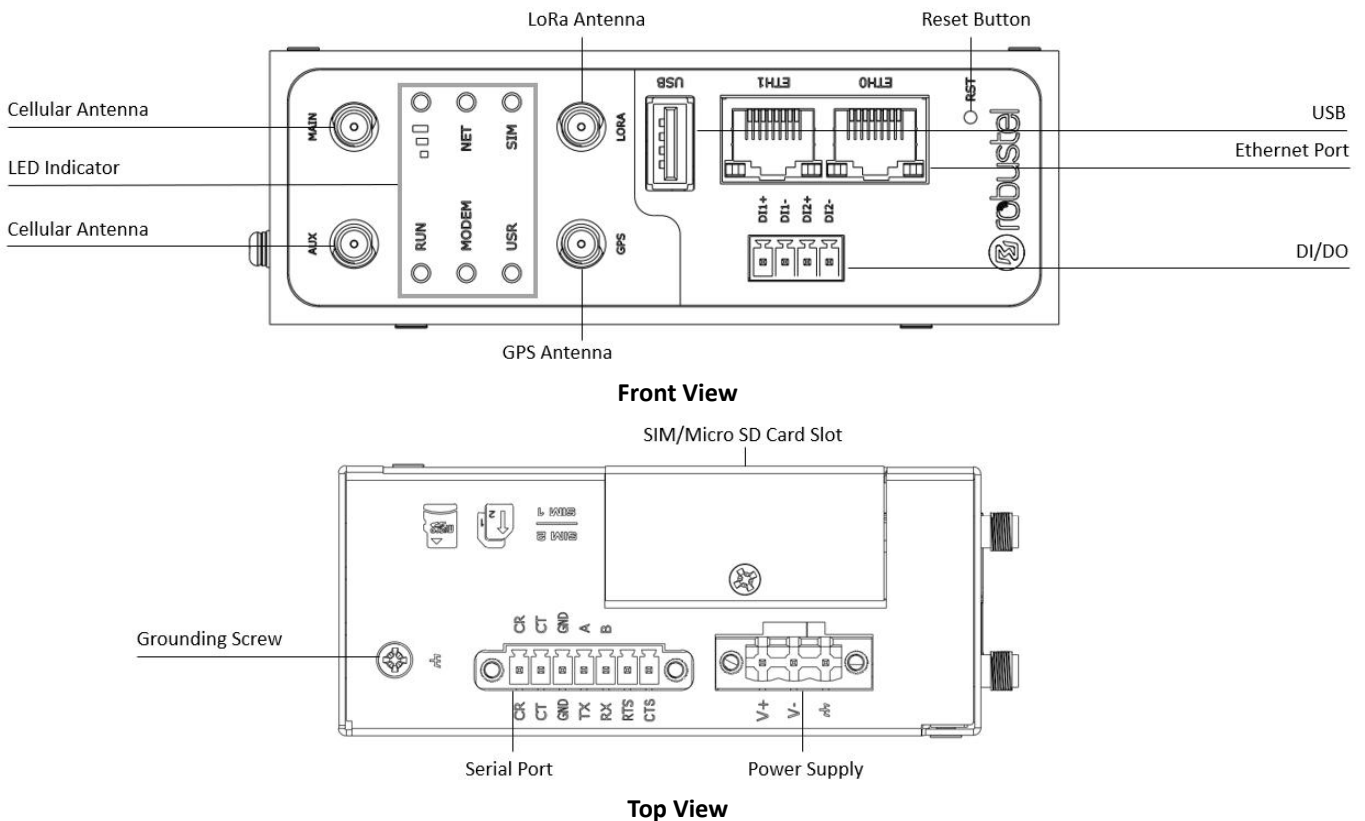

Interface Descriptions

1. PIN Assignment

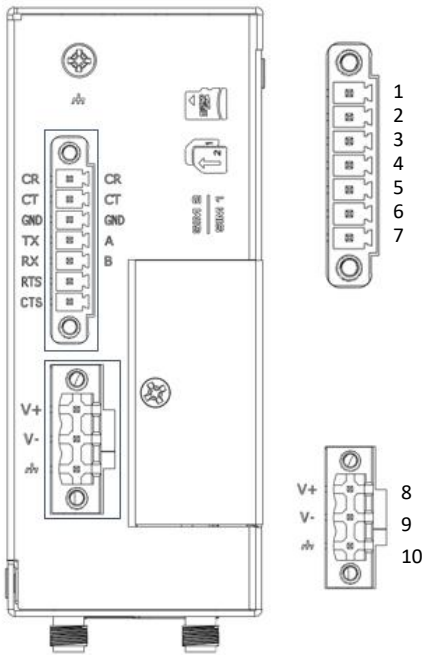

PIN	Debug	RS-232	RS-485	Direction
1	CR	--	--	Gateway ← Device
2	CT	--	--	Gateway → Device
3	GND	GND	GND	--
4	--	TXD	Data+(A)	Gateway → Device
5	--	RXD	Data+(B)	Gateway ← Device
6	--	RTS	--	Gateway → Device
7	--	CTS	--	Gateway ← Device

PIN	Polarity
8	Positive
9	Negative
10	GND

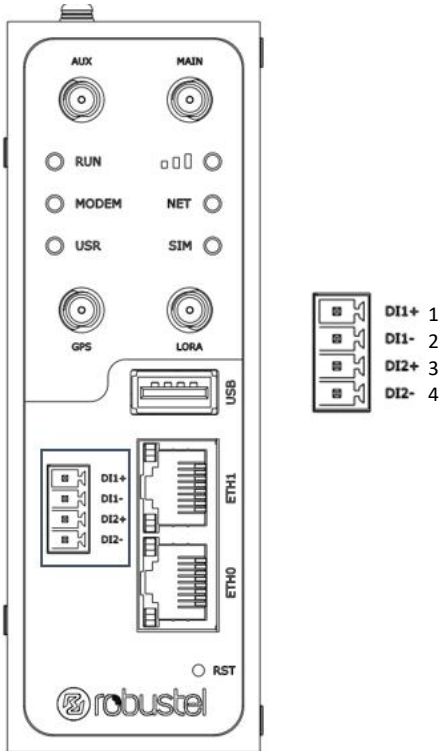

PIN	DI	Direction
1	DI1+	Gateway ← Device
2	DI1-	Gateway ← Device
3	DI2+	Gateway ← Device
4	DI2-	Gateway ← Device

Typical Application :

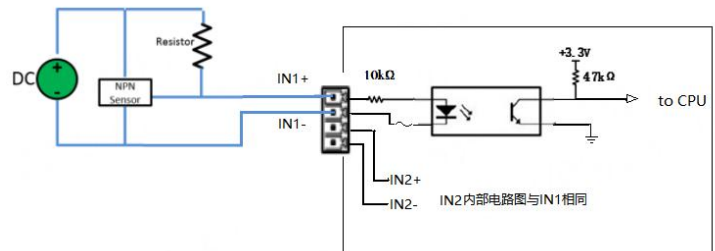

DI Connection

2. USB Interface.

Function	Operation
Firmware upgrade	USB interface is used for batch firmware upgrading, but cannot be used for sending or receiving data from slave devices which connected to it. You can insert a USB storage device into the gateway's USB interface, such as a U disk or a hard disk. If there have a supported configuration file or a gateway firmware in this USB storage device, the gateway will automatically update the configuration file or the firmware. For more details, see <i>RT123_SM_RobustOS Software Manual</i> .

3. LED Indicator.

Name	Color	Status	Description
RUN	Green	On, fast blinking (250ms blink time)	Gateway is powered on (System is initializing)
		On, blinking (500ms blink time)	Gateway starts operating
		Off	Gateway is powered off
MODEM	Green	On, solid	Link connection is working
		Off	Link connection is not working
USR-OpenVPN	Green	On, solid	OpenVPN connection is established
		Off	OpenVPN connection is not established
USR-IPsec	Green	On, solid	IPsec connection is established
		Off	IPsec connection is not established
	Green	On, solid	High Signal strength (21-31) is available
	Yellow	On, solid	Medium Signal strength (11-20) is available
	Red	On, solid	Low Signal strength (1-10) is available
	/	Off	No signal
NET	Green	On, solid	Connection to 4G network is established
	Yellow	On, solid	Connection to 3G network is established
	Red	On, solid	Connection to 2G network is established
	/	Off	Connection to network is not established or establishing
SIM	Green	On, Solid	Main card is being used
		On, blinking	Backup card is being used
		Off	No SIM card

Note: You can choose the display type of USR LED. For more details, please refer to

RT123_SM_RobustOS Software Manual Service > Advanced > System > System Settings > User LED Type.

4. Reset Button.

Function	Operation
Reboot	Press and hold the RST button for 2~ 5 seconds under the operating status.
Restore to default configuration	Press and hold the RST button for 5~10 seconds, the RUN LED starts blinking quickly, the router will restore to default configuration.
Restore to factory default settings	Once the operation of restoring default configuration is performed twice within one minute, the router will restore to factory default settings.

Note: The more details please refer to ***RT123_SM_RobustOS Software Manual, 2.3 Factory Reset.***

5. Ethernet Ports. There are two Ethernet ports on R3000 LG, including ETH0 and ETH1. Each Ethernet port has two LED indicators. The yellow one is a link indicator, while the green one is a speed indicator. For details about status, see the table below.

Indicator	Status	Description
Link indicator	On, solid	Connection is established
	On, blinking	Data is being transferred
	Off	Connection is not established
Speed indicator	On, solid	100 Mbps mode
	Off	10 Mbps mode

Hardware Installation

- 1. SIM Card Installation.** Loosen the screws associated with the cover by using a screwdriver and then find the SIM card slot/Micro SD card slot. Press the card with finger until you hear a click and then tighten the screws associated with the cover by using a screwdriver. Put back the cover and tighten the screws associated with the cover by using a screwdriver.

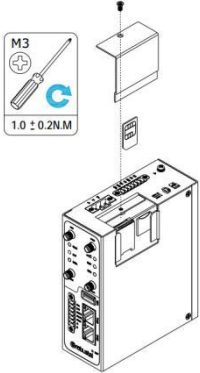

- 2. Antenna Installation.** Rotate the antenna into the antenna connector accordingly.

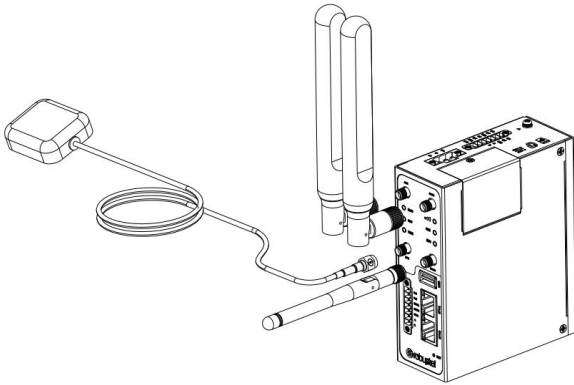

- 3. Mounting Kit installation. (Optional)**

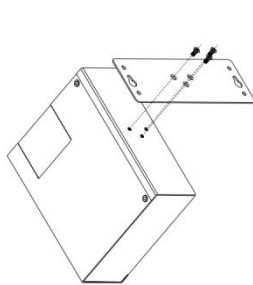

Wall mounting

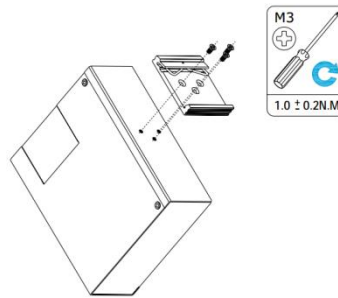

DIN rail mounting

- 4. Terminal Block Installation.** Insert the terminal blocks into the interfaces connector, then can connect the devices or sensors to the gateway via corresponding interfaces e.g. RS232/RS485, DIDO...

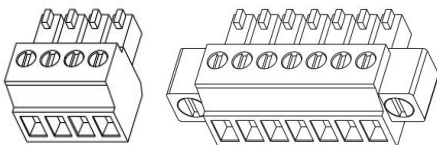

- 5. Grounding the Device.** Grounding will help to prevent the noise effect due to electromagnetic interference (EMI). Connect the device to the site ground wire by the grounding screw before powering on.

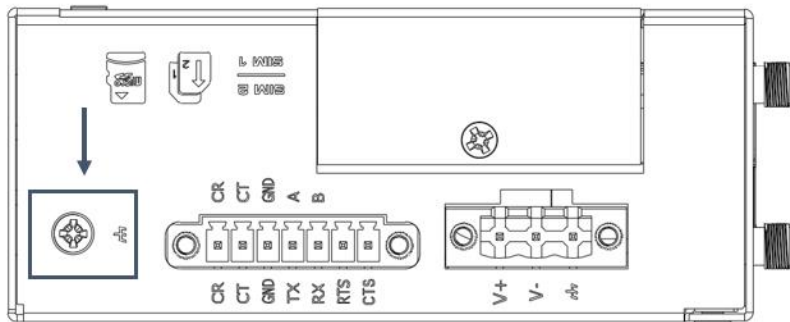

- 6. Power Supply installation.** Following to the color of the head, connect the cable marked red to the positive pole through a terminal block, and connect the yellow one to the negative in the same way.

Note: The range of power voltage is 9 to 60V DC.

CONNECTING THE POWER CABLE

COLOR	POLARITY
RED	+
YELLOW	-

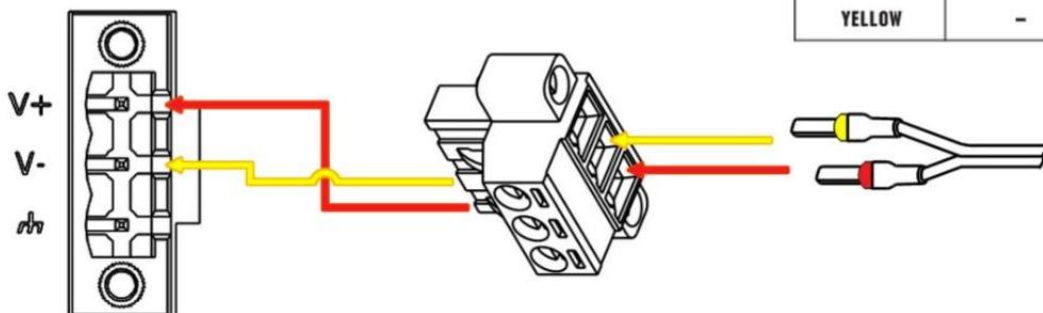

Login to the Device

1. Connect the router’s Ethernet port to a PC with a standard Ethernet cable.
2. Before logging in, manually configure the PC with a static IP address on the same subnet as the gateway address, click and configure "Use the following IP address".

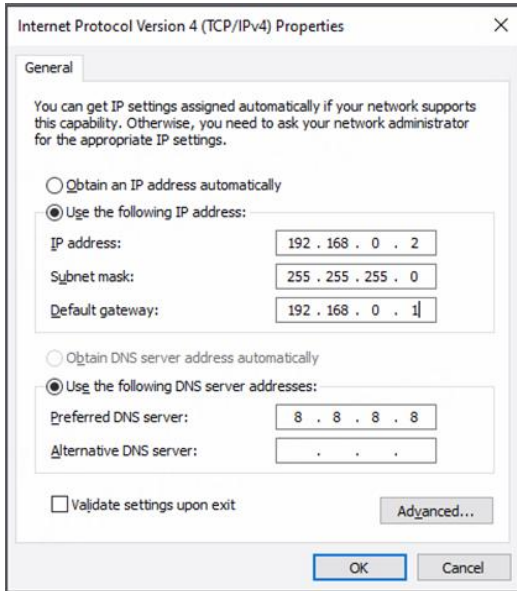

3. To enter the gateway's web interface, type <http://192.168.0.1> into the URL field of your Internet browser.
4. Use login information shown in the product label when prompted for authentication.



5. After logging in, the home page of the web interface is displayed, then you can view system information and perform configuration on the device.

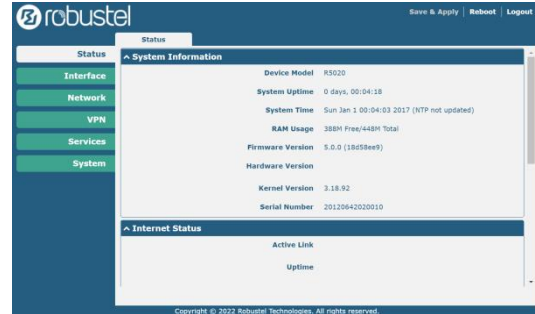

6. The automatic APN selection is ON by default, if need to specify your own APN, please go to the menu **Interface->Link Manager->Link Setting->WWAN Settings** to finish the specific setting.

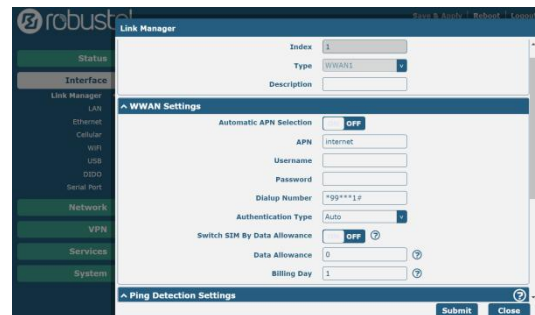

7. The more configuration details please refer to **RT123_SM_RobustOS Software Manual**.
(END)