

NK-6183

3.5 inch Alder Lake-N i3-N305/N97 Single Board

特点 Feature

- Intel® Core™ N-series N97, Quad-core, base frequency 2.0GHz up to 3.6GHz, TDP 12W
- Intel® Core™ i3-N305 processor, Quad-core, base frequency 1.8GHz up to 3.8GHz, TDP 15W
- Support 1 x DDR5-4800MHz SO-DIMM slot, up to 16GB
- Support DP, HDMI, LVDS/eDP Tri-display
- 2 x Giga-bit Ethernet
- 2 x USB3.2 ports, 4 x USB2.0 ports
- 1 x RS232/485, 1 x RS232, 4 x TTL
- 1 x M.2-2242/2280 NVME, 1 x Mini-PCIe slot with nano-SIM card socket
- 12~24V power input, lockable DC-IN phoenix terminal block

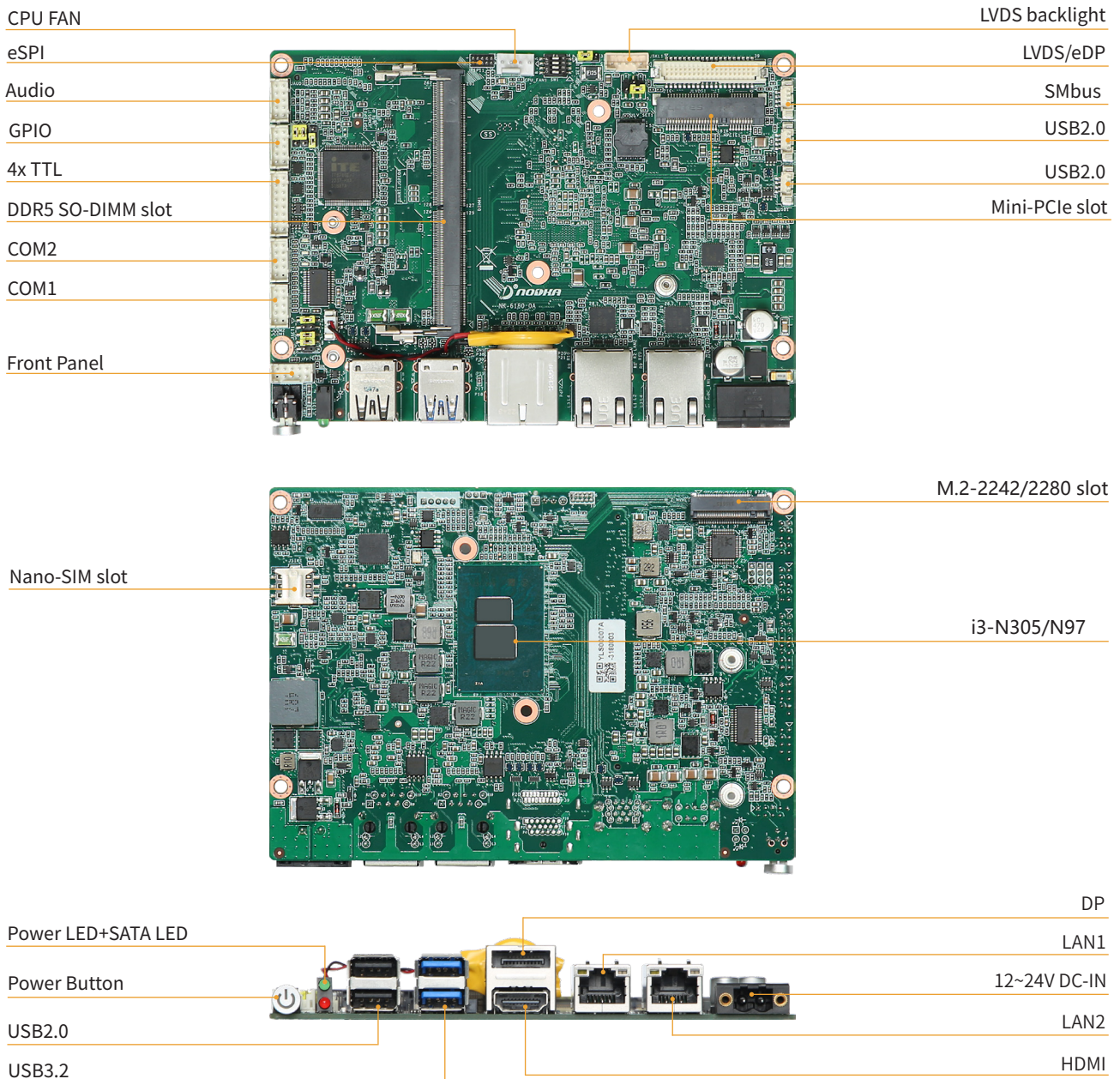

规格 Specification

处理器 Processor System	CPU	Intel® Core™ i3-N305/N97 processor GHz, up to 3.8GHz,TDP 15W
	芯片组 Chipset	Intel® SoC integrated
	BIOS	AMI 256Mb UEFI BIOS
内存 Memory	技术 Technology	Single Channel(Non-ECC) DDR5-4800MHz, up to 16GB
	插槽 Slot	1 x DDR5 262-pin SO-DIMM slot
存储 Storage	M.2	1 x M.2-2242/2280 M Key SSD slot(SATA3.0/NVME)
图形 Graphic	控制器 Controller	Intel® UHD graphics integrated
音频 Audio	编码器 Codec	Realtek ALC897 codec
外部接口 Rear I/O	显示 Display	1 x DP1.4, resolution up to 4096x2160@60Hz
		1 x HDMI, resolution to 4096 x 2160@30Hz
	网络 Ethernet	2 x GbE(RJ45), Intel i226-V controller
	USB	2 x USB3.2(10Gbps), 2 x USB2.0(480Mbps)
	开关按钮 Button	1 x Power Button(White for power on,Blink for sleep mode,Off for power off)
指示灯 Indicators	1 x SATA LED(Red),1 x Power LED(Green)	
内部接口 Internal I/O	显示 Display	1 x LVDS, dual channel 18/24bit, resolution up to 1920x1200@60Hz
		1 x eDP1.3, resolution up to 4096x2160@60Hz(share connector with LVDS)
	音频 Audio	1 x Audio wafer(Mic-in/Line-out, 2*5pin)
	USB	2 x USB2.0 wafer(1*4pin)
	串口 Serial Port	1 x RS232/485 wafer(2*5pin), 1 x RS232 wafer(2*5pin), 4 x TTL wafer(2*8pin)
	风扇 Fan	1 x Smart Fan wafer(1*4pin)
	SMbus	1 x SMbus wafer(1*4pin)
	GPIO	1 x8bit GPIO wafer(2*5pin)
	eSPI	1 x eSPI header for debug
其他 Others	1 x Front panel wafer(2*5pin)(Power LED, HDD LED, Power button, Reset button)	
扩展接口 Expansion Slots	Mini-PCIe slot	1 x Mini-PCIe slot with Nano-SIM socket(PCIe/USB2.0)
安全 Security	TPM	fTPM2.0
看门狗定时器 Watchdog Timer	输出 & 间隔 Output&Interval	System reset, programmable from 1~255 seconds
电源 Power	类型 Type	12~24V DC input, +/-10% tolerance
	接口 Interface	1 x 2-pin phoenix terminal block
	功耗 Power Consumption	TBD
操作系统 O.S Support	MS Windows	Windows10/11
	Linux	Linux
机械参数 Mechanism	尺寸 Dimensions	(L)146mm x (W)102mm
	净重 Gross Weight	0.8kg
环境 Environment	温度 Temperature	Operating: -10°C ~60°C with SSD
	湿度 Humidity	Storage: -40°C ~85°C
	湿度 Humidity	5~95% (Non-condensing)
	振动 Vibration	5~500Hz, 3Grms operating

框架图 Block Diagram

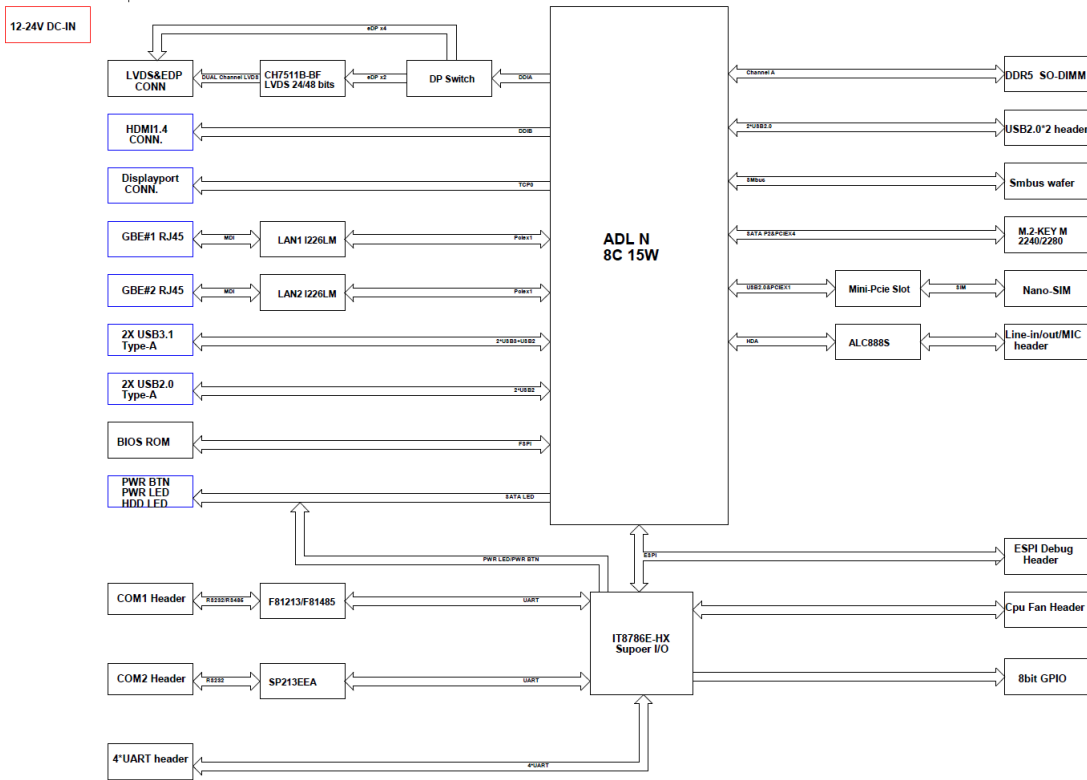

机构图 Mechanical Drawing

单位 (Unit): mm

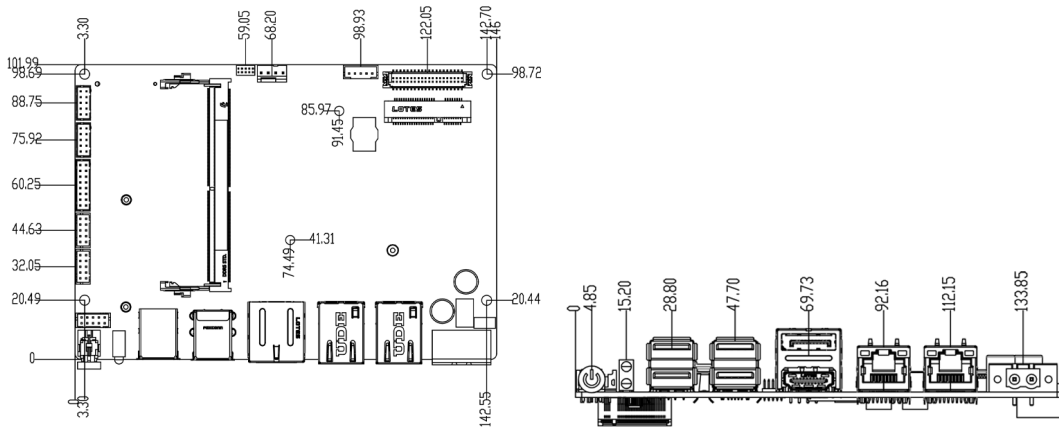

订购信息 Order Information

料号 Part No.	型号 Model	描述 Description
F32.618305.10.NEK	NK-6183-N305	3.5", Alder Lake-N, I3-N305, DDR5 SO DIMM, M.2-2280(SATA3.0/NVME), Standard, compose, 2*COM Cable, w/ALC897,w/210AT
F32.618304.10.NEK	NK-6183-N97	3.5", Alder Lake-N, N97, DDR5 SO DIMM, M.2-2280(SATA3.0/NVME), Standard, compose, 2*COM Cable, w/ALC897,w/210AT

包装清单 Packing List

料号 Part No.	数量 Qty	描述 Description
KF0.000889.00.A21	2	COM Cable,2*5pin wafer to DB9 cable, length=150mm
JF7.000041.00.D03	1	2-pin termianl block,pitch 5.08mm

可选配件 Optional Accessories

料号 Part No.	描述 Description
C2Z.618001.0A.NDJ	Heatsink for NK-6183
C3Z.NKEB01.10.NDJ	AEB-4COM00, 2 x RS485/422/232(DB9) ,2 x RS232 wafer I/O expansion kit
C3Z.0001.00.NDJ	CM-060W-CWT0, 12V/60W adapter, 180cm power cord
C3Z.0002.00.NDJ	CM-090W-HKA, 12V/84W adapter, 180cm power cord
KF0.001046.00.L54	COM Cable,2*5pin wafer to DB9 cable, length=150mm
KF0.001047.00.L54	USB cable, 1*4pin wafer to USB2.0 type-A cable, length=150mm
KF0.000949.00.Y09	Audio Cable, 2*5pin wafer to Mic-in/Line-out cable, length=300mm