



NEXCOM International Co., Ltd.

IoT Automation Solutions

Industrial Panel PC

IPPC A1570T/P, IPPC 1670P,

IPPC A1770T, IPPC A1770P &

IPPC A1770TF (Fan Model) Series

IPPC A1970T/P & IPPC 2170P Series

User Manual

CONTENTS

Preface

Copyright	v
Disclaimer	v
Acknowledgements	v
Regulatory Compliance Statements	v
Declaration of Conformity	v
RoHS Compliance	vi
Warranty and RMA	vii
Safety Information	x
Installation Recommendations	x
Safety Precautions	xi
Technical Support and Assistance	xii
Conventions Used in this Manual	xii
Global Service Contact Information	xiii
Package Contents	xv
Ordering Information	xviii

Chapter 1: Product Introduction

IPPC A1570T/P Series	1
Key Features	1
Specifications	2
IPPC 1670P	4
Key Features	4
Specifications	5
IPPC A1770T/P Series	7

Key Features	7
Specifications	8
IPPC A1970T/P Series	11
Key Features	11
Specifications	12
IPPC 2170P-DC	14
Key Features	14
Specifications	15
Knowing Your IPPC A1770T/P Series	17
IPPC A1770T/P-DC Rear Bottom	17
IPPC A1770T/P-DC Rear Top	17
IPPC A1770T/P-AC Rear Bottom	18
IPPC A1770T/P-AC Rear Top	18
Knowing Your IPPC A1770TF-DC (Fan Model)	19
IPPC A1770TFE-DC Rear Bottom	19
IPPC A1770TFE-DC Rear Top	19
Knowing Your IPPC A1570T/P-DC, IPPC 1670P-DC, IPPC A1970T/P-DC, IPPC 2170P-DC Series	20
Rear Bottom	20
Rear Top	20
IPPC A1770TF-DC Rear (Fan Model)	21
IPPC A1770T/P-DC Rear	22
IPPC A1770T/P-AC Rear	23
IPPC A1570T/P-DC, IPPC 1670P-DC, IPPC A1970T/P-DC, IPPC 2170P-DC Rear	24
Mechanical Dimensions	25

IPPC A1570T/P-DC	25
IPPC 1670P-DC.....	26
IPPC A1770T/P-DC	27
IPPC A1770T/P-AC	28
IPPC A1770TF-DC (Fan Model)	29
IPPC A1970T/P-DC	30
IPPC 2170P-DC.....	31

Chapter 2: Jumpers and Connectors

Before You Begin	32
Precautions	32
Jumper Settings	33
Locations of the Jumpers and Connectors	34
Top View	34
Bottom View	35
Jumpers and DIP Switch Settings.....	36
RTC Clear Select	36
AT/ATX Selection	36
Panel Resolution Select	37
Dimming Signal Level Select	37
LCD Panel VDD Power Select	38
COM1 and COM2 Power Select	38
Touch 4/5 Wire Select	39
Connector Pin Definitions	40
External I/O Interface	40
Reset Button	40
Audio Connectors	40
LAN1 and Dual USB3.0 Ports.....	41
LAN2 and Dual USB3.0 Ports.....	42
DisplayPort.....	43
DVI-I Connector	43
Remote Power Button Connector.....	44

12~30V DC Power Input (DC-Powered Models Only)	44
CFast Slot.....	45
SIM Card Slot.....	45
Internal Connectors	46
DC Input	46
DC Output	46
Power Button	47
Backlight and Dimming Control Input Connector	47
LCD Backlight Connector	48
LVDS Channel A Connector.....	48
LVDS Channel B Connector	49
Touch Sensor Connector	49
Internal USB Connector.....	50
Front USB Connector	50
Internal USB Connector.....	51
USB Connector	51
SATA0 Connector.....	52
SATA1 Connector.....	52
SATA/SATA DOM Power Connectors.....	53
Speaker-out Pin Header.....	53
COM1 Connector (Isolation with RS422/485 Feature).....	54
COM2 Connector (Isolation with RS422/485 Feature).....	54
DIO Connector.....	55
GPIO Connector	55
RTC Battery Connector.....	56
Active LED Connector	56
Software Programming IO Connector.....	57
Keyboard/Mouse Connector.....	57
CPU Fan Connector.....	58
System Fan Connector	58
Printer Port Connector	59
Mini-PCIe Slot (Wi-Fi/3G).....	60



Mini-PCIe Slot (PCIe/mSATA)	61
PCIe x16 Slot.....	62

Chapter 3: System Setup

Installing a Riser Card	64
Alternative Method for Fixing the Riser Card.....	69
Installing a CFast Card and Mini-PCIe 3G/4G SIM Card.....	73
Installing a Mini-PCIe Module.....	75
Installing a CPU.....	76
Installing a SO-DIMM Memory Module	80
Installing a Primary 2.5" HDD/SDD (-AC Model Only)	81
Installing a Secondary 2.5" HDD/SDD.....	82
Panel Mounting	85

Chapter 4: BIOS Setup

About BIOS Setup.....	87
When to Configure the BIOS.....	87
Default Configuration	88
Entering Setup	88
Legends.....	88
BIOS Setup Utility.....	90
Main	90
Advanced	91
Chipset.....	97
Boot.....	102
Security	103
Save & Exit	104

Appendix A: EC Command Documentation

General Purpose of EC.....	105
Abbreviation.....	105
PM1 (Power Management Channel1) Overview	105

1. Digital I/O & EC_GPI/O	106
1.1 Command Register and Address Description:	106
1.2 Read Description:	106
1.3 Setting description:	107
DIO Control.....	107
1.4 Command Register and Address Description:	107
1.5 Read DIO Command Description:	108
1.6 Write DIO Command Description:	108
Watchdog	109
1.7 Command Register and Address Description:	109
1.8 Setup Watchdog Time Interval Description:	109
1.9 Reset Watchdog Time Interval Description:	110
1.10 Start Watchdog Description:.....	110
1.11 Stop Watchdog Description:.....	110
2. HW Monitor	111
2.1 Command Register and Address Description:	111
2.2 Read HW Monitor Description:.....	111

Appendix B: Triple Display Settings112

PREFACE

Copyright

This publication, including all photographs, illustrations and software, is protected under international copyright laws, with all rights reserved. No part of this manual may be reproduced, copied, translated or transmitted in any form or by any means without the prior written consent from NEXCOM International Co., Ltd.

Disclaimer

The information in this document is subject to change without prior notice and does not represent commitment from NEXCOM International Co., Ltd. However, users may update their knowledge of any product in use by constantly checking its manual posted on our website: <http://www.nexcom.com>. NEXCOM shall not be liable for direct, indirect, special, incidental, or consequential damages arising out of the use of any product, nor for any infringements upon the rights of third parties, which may result from such use. Any implied warranties of merchantability or fitness for any particular purpose is also disclaimed.

Acknowledgements

The IPPC A1770 and IPPC A1970 series are trademarks of NEXCOM International Co., Ltd. All other product names mentioned herein are registered trademarks of their respective owners.

Regulatory Compliance Statements

This section provides the FCC compliance statement for Class A devices and describes how to keep the system CE compliant.

Declaration of Conformity

FCC

This equipment has been tested and verified to comply with the limits for a Class A digital device, pursuant to Part 15 of FCC Rules. These limits are designed to provide reasonable protection against harmful interference when the equipment is operated in a commercial environment. This equipment generates, uses, and can radiate radio frequency energy and, if not installed and used in accordance with the instructions, may cause harmful interference to radio communications. Operation of this equipment in a residential area (domestic environment) is likely to cause harmful interference, in which case the user will be required to correct the interference (take adequate measures) at their own expense.

CE

The product(s) described in this manual complies with all applicable European Union (CE) directives if it has a CE marking. For computer systems to remain CE compliant, only CE-compliant parts may be used. Maintaining CE compliance also requires proper cable and cabling techniques.

RoHS Compliance



NEXCOM RoHS Environmental Policy and Status Update

NEXCOM is a global citizen for building the digital infrastructure. We are committed to providing green products and services, which are compliant with European Union RoHS (Restriction on Use of Hazardous Substance in Electronic Equipment) directive 2011/65/EU, to be your trusted green partner and to protect our environment.

RoHS restricts the use of Lead (Pb) < 0.1% or 1,000ppm, Mercury (Hg) < 0.1% or 1,000ppm, Cadmium (Cd) < 0.01% or 100ppm, Hexavalent Chromium (Cr6+) < 0.1% or 1,000ppm, Polybrominated biphenyls (PBB) < 0.1% or 1,000ppm, and Polybrominated diphenyl Ethers (PBDE) < 0.1% or 1,000ppm.

In order to meet the RoHS compliant directives, NEXCOM has established an engineering and manufacturing task force to implement the introduction of green products. The task force will ensure that we follow the standard NEXCOM development procedure and that all the new RoHS components and new manufacturing processes maintain the highest industry quality levels for which NEXCOM are renowned.

The model selection criteria will be based on market demand. Vendors and suppliers will ensure that all designed components will be RoHS compliant.

How to recognize NEXCOM RoHS Products?

For existing products where there are non-RoHS and RoHS versions, the suffix "(LF)" will be added to the compliant product name.

All new product models launched after January 2013 will be RoHS compliant. They will use the usual NEXCOM naming convention.

Warranty and RMA

NEXCOM Warranty Period

1. NEXCOM makes products in accordance with the Industry standard and, NEXCOM warrants that all her Industry-grade IPC and System products will be free from defect in neither material nor workmanship for twenty-four (24) months from the day of invoice issued.
2. For NEXCOM Panel PC product lines (the IPPC, APPC and MPPC series), they are also guaranteed against defect in materials and workmanship for the period of twenty-four (24) months in their motherboard design. For 3rd party parts, it follows with original suppliers' standard: 12 months for battery pack and LCD, 24 months for adaptor / add on modules (including GSM module, RFID module, and antenna).
3. If NEXCOM determines customer's warranty claim is valid, NEXCOM will repair or replace product(s) without additional charge for parts and labor. An extended Warranty Program will extend the warranty period of the product accordingly.

Warranty Coverage

The warranty applies only to products manufactured or distributed by NEXCOM and her subsidiaries. This warranty covers all the products/shipments except for:

1. Any claimed defect, products that have been repaired or modified by persons who have not been authorized by NEXCOM or, products which have been subjected to misuse, abuse, accident, improper installation, or usage not in accordance with the product instruction. NEXCOM assumes no liability as a consequence of such events under the term of this warranty.

One example is the replacement of Tablet's or Hand-held's LCD display due to scratching stains or other degradation; these will not be covered under this warranty.

2. Damages caused by customers' delivery/shipping of the product or, product failure resulted from electrical power/voltage shock, or, installation of parts/components which are not supplied/approved by NEXCOM in advance.
3. Third-party products:
 - a. Software, such as the device drivers,
 - b. External devices such as HDD, printer, scanner, mouse, LCD panel, battery, and so on,
 - c. Accessory/parts that were not approved by NEXCOM and,
 - d. Accessory/parts were added to products after they were shipped from NEXCOM.

Product will be treated as "Out of Warranty " if:

- a. It expires the warranted 24 months period from the day it was purchased.
- b. It had been altered by persons other than an authorized NEXCOM service person or, which have been subjected to misuse, abuse, accident, or improper installation.
- c. It doesn't have the original NEXCOM Serial Number labeling for NEXCOM's warranty period identification or, tracking.

RMA that NEXCOM has determined not to be covered by the warranty will be charged the NEXCOM Standard Repair Fee for the repairing. If a RMA is determined to be not repairable, customer will be notified and product(s) may be returned to customer at their request; a minimum service fee may be charged however.

NEXCOM Return Merchandise Authorization (RMA) Procedure

For the RMA (Return Merchandise Authorization) shipment, customer is responsible for packaging and shipping the product to the designated NEXCOM service sites, with shipping charges prepaid by the customer. The original NEXCOM shipping box should be used whenever possible. NEXCOM shall pay for the return of the product to the customer's location. In case of expedited shipping request, an extra service charge shall be assessed and the customer is responsible for this extra return shipping charge.

1. Customers should enclose the "NEXCOM RMA Service Form" with the returned products.
2. Customers need to write down all the information related to the problem on the " NEXCOM RMA Service Form " when applying for the RMA service; information will help to understand the problem, including the fault description, on-screen messages, and pictures if possible.
3. Customers could send back the faulty product with or without the accessories and key parts such as the CPU and DIMM. If the key parts are included, please be noted clearly within the return form. NEXCOM takes no responsibility for the parts which are not listed in the return form.
4. Customers hold the responsibility to ensure that the packing of defective products is durable enough to be resistant against further damage due to the transportation; damage caused by transportation is treated as " Out of Warranty " under our Warranty specification.
5. RMA product(s) returned by NEXCOM to any location other than the

customer registered delivery address will incur an extra shipping charge, the customer is responsible for paying the extra shipping charges, duties, and taxes of this shipment.

Product Repairing

1. NEXCOM will repair defective products covered under this limited warranty that are returned to NEXCOM; if products do prove to be defective, they will be repaired during their warranty period unless other warranty terms have been specified.
2. NEXCOM owns all parts removed from repaired products.
3. NEXCOM will use parts made by various manufacturers in performing the repair.
4. The repaired products will be warranted subjected to the original warranty coverage and period only.
5. For products returned as defective but, proved to be no defect/fault after the RMA process, NEXCOM reserves the right to claim for a NDF (No Defect Found) Service Charge.
6. NEXCOM will issue RMA Report which included Repair Detailed Information to the customer when the defective products were repaired and returned.
7. In addition to the above, NEXCOM may authorize Independent/Third-party suppliers to repair the defective products for NEXCOM.

Out Of Warranty Service

There will be a service charge from NEXCOM for the “Out Of Warranty” product service; they are the Basic Diagnostic Service Fee and the Advanced Component Replacement Fee respectively. And, if the product can not be repaired, NEXCOM will either return the product to the customer or, just scrap it, followed by customer’s instruction.

1. Testing and Parts Replacement

NEXCOM will have the following Handling Charges for those OoW products that returned:

- a. Basic Labor Cost and Testing Fee: as Table listed.
 - b. Parts Fee: NEXCOM will charge for main IC chipsets such as the N.B., S.B., Super-IO, LAN, Sound, Memory, and so on.
 - c. 3rd-party Device Fee: products replacement for CPU, DIMM, HDD, Chassis, and UPS.
2. Out of Warranty product will have a three months warranty for the fixed issues. If the product failed with different problem within 3 months, they will still incur the service charge of “Out of Warranty” .
3. Out of Warranty “products will not be repaired without a signed PI from the customer, the agreement of the repair process.

Add-on card, 3rd Party Device and board level repair cost higher than new product prices, customer can abandon to sign PI to repair and, please contact with sales to buy new products.

Safety Information

Before installing and using the device, note the following precautions:

- Read all instructions carefully.
- Do not place the unit on an unstable surface, cart, or stand.
- Follow all warnings and cautions in this manual.
- When replacing parts, ensure that your service technician uses parts specified by the manufacturer.
- Avoid using the system near water, in direct sunlight, or near a heating device.
- The load of the system unit does not solely rely for support from the rackmounts located on the sides. Firm support from the bottom is highly necessary in order to provide balance stability.
- Maximum surrounding air temperature should not exceed 50°C.
- For use in Pollution Degree 2 Environment.
- Follow all mounting guidelines and instructions on Chapter 3 of the manual.
- Suitable for mounting on the flat surface of Type 2 and Type 4X indoor use only enclosure.

Caution:

FOR USE IN A CONTROLLED ENVIRONMENT, REFER TO MANUAL FOR ENVIRONMENTAL CONDITIONS.



Attention:

POUR UTILISATION EN ATMOSPHERE CONTROLEE, CONSULTER LA NOTICE TECHNIQUE.

Installation Recommendations

Ensure you have a stable, clean working environment. Dust and dirt can get into components and cause a malfunction. Use containers to keep small components separated.

Adequate lighting and proper tools can prevent you from accidentally damaging the internal components. Most of the procedures that follow require only a few simple tools, including the following:

- A Philips screwdriver
- A flat-tipped screwdriver
- A grounding strap
- An anti-static pad

Using your fingers can disconnect most of the connections. It is recommended that you do not use needle-nose pliers to disconnect connections as these can damage the soft metal or plastic parts of the connectors.

Safety Precautions

1. Read these safety instructions carefully.
2. Keep this User Manual for later reference.
3. Disconnect this equipment from any AC outlet before cleaning. Use a damp cloth. Do not use liquid or spray detergents for cleaning.
4. For plug-in equipment, the power outlet socket must be located near the equipment and must be easily accessible.
5. Keep this equipment away from humidity.
6. Put this equipment on a stable surface during installation. Dropping it or letting it fall may cause damage.
7. The openings on the enclosure are for air convection to protect the equipment from overheating. **DO NOT COVER THE OPENINGS.**
8. Make sure the voltage of the power source is correct before connecting the equipment to the power outlet.
9. Place the power cord in a way so that people will not step on it. Do not place anything on top of the power cord. Use a power cord that has been approved for use with the product and that it matches the voltage and current marked on the product's electrical range label. The voltage and current rating of the cord must be greater than the voltage and current rating marked on the product.
10. All cautions and warnings on the equipment should be noted.
11. If the equipment is not used for a long time, disconnect it from the power source to avoid damage by transient overvoltage.
12. Never pour any liquid into an opening. This may cause fire or electrical shock.
13. Never open the equipment. For safety reasons, the equipment should be opened only by qualified service personnel.
14. If one of the following situations arises, get the equipment checked by service personnel:
 - a. The power cord or plug is damaged.
 - b. Liquid has penetrated into the equipment.
 - c. The equipment has been exposed to moisture.
 - d. The equipment does not work well, or you cannot get it to work according to the user's manual.
 - e. The equipment has been dropped and damaged.
 - f. The equipment has obvious signs of breakage.
15. Do not place heavy objects on the equipment.
16. The unit uses a three-wire ground cable which is equipped with a third pin to ground the unit and prevent electric shock. Do not defeat the purpose of this pin. If your outlet does not support this kind of plug, contact your electrician to replace your obsolete outlet.
17. **CAUTION: DANGER OF EXPLOSION IF BATTERY IS INCORRECTLY REPLACED. REPLACE ONLY WITH THE SAME OR EQUIVALENT TYPE RECOMMENDED BY THE MANUFACTURER. DISCARD USED BATTERIES ACCORDING TO THE MANUFACTURER'S INSTRUCTIONS.**

Technical Support and Assistance

1. For the most updated information of NEXCOM products, visit NEXCOM's website at www.nexcom.com.
2. For technical issues that require contacting our technical support team or sales representative, please have the following information ready before calling:
 - Product name and serial number
 - Detailed information of the peripheral devices
 - Detailed information of the installed software (operating system, version, application software, etc.)
 - A complete description of the problem
 - The exact wordings of the error messages

Warning!

1. Handling the unit: carry the unit with both hands and handle it with care.
2. Maintenance: to keep the unit clean, use only approved cleaning products or clean with a dry cloth.
3. CFast: Turn off the unit's power before inserting or removing a CFast storage card.

Conventions Used in this Manual



Warning:

Information about certain situations, which if not observed, can cause personal injury. This will prevent injury to yourself when performing a task.



Caution:

Information to avoid damaging components or losing data.



Note:

Provides additional information to complete a task easily.



Safety Warning: This equipment is intended for installation in a Restricted Access Location only.

Global Service Contact Information

Headquarters

NEXCOM International Co., Ltd.

9F, No. 920, Chung-Cheng Rd.,
ZhongHe District, New Taipei City, 23586,
Taiwan, R.O.C.

Tel: +886-2-8226-7786

Fax: +886-2-8226-7782

www.nexcom.com

America

USA

NEXCOM USA

2883 Bayview Drive,
Fremont CA 94538, USA

Tel: +1-510-656-2248

Fax: +1-510-656-2158

Email: sales@nexcom.com

www.nexcom.com

Asia

Taiwan

NEXCOM Intelligent Systems

Taipei Office

13F, No.920, Chung-Cheng Rd.,
ZhongHe District,
New Taipei City, 23586, Taiwan, R.O.C.

Tel: +886-2-8226-7796

Fax: +886-2-8226-7792

Email: sales@nexcom.com.tw

www.nexcom.com.tw

NEXCOM Intelligent Systems

Taichung Office

16F, No.250, Sec. 2, Chongde Rd.,
Beitun Dist.,

Taichung City 406, R.O.C.

Tel: +886-4-2249-1179

Fax: +886-4-2249-1172

Email: sales@nexcom.com.tw

www.nexcom.com.tw

Japan

NEXCOM Japan

9F, Tamachi Hara Bldg.,
4-11-5, Shiba Minato-ku,
Tokyo, 108-0014, Japan

Tel: +81-3-5419-7830

Fax: +81-3-5419-7832

Email: sales@nexcom-jp.com

www.nexcom-jp.com

China

NEXCOM China

Floor 5, No.4, No.7 fengxian middle Rd.,
(Beike Industrial Park), Haidian District,
Beijing, 100094, China

Tel: +86-10-5704-2680

Fax: +86-10-5704-2681

Email: sales@nexcom.cn

www.nexcom.cn

NEXCOM Shanghai

Room 603/604, Huiyinmingzun Plaza Bldg., 1,
No.609, Yunlin East Rd.,
Shanghai, 200333, China
Tel: +86-21-5278-5868
Fax: +86-21-3251-6358
Email: sales@nexcom.cn
www.nexcom.cn

NEXCOM Surveillance Technology Corp.

Room202, Building B,
the GuangMing Industrial Zone Zhonghua Rd.,
Minzhi Street, Longhua District,
Shenzhen 518131, China
Tel: +86-755-8364-7768
Fax: +86-755-8364-7738
Email: steveyang@nexcom.com.tw
www.nexcom.cn

NEXCOM United System Service

Hui Yin Ming Zun Building Room 1108,
Building No. 11, 599 Yunling Road, Putuo District,
Shanghai, 200062, China
Tel: +86-21-6125-8282
Fax: +86-21-6125-8281
Email: frankyang@nexcom.cn
www.nexcom.cn

Europe

United Kingdom

NEXCOM EUROPE

10 Vincent Avenue,
Crownhill Business Centre,
Milton Keynes, Buckinghamshire
MK8 0AB, United Kingdom
Tel: +44-1908-267121
Fax: +44-1908-262042
Email: sales.uk@nexcom.eu
www.nexcom.eu

Italy

NEXCOM ITALIA S.r.l

Via Lanino 42,
21047 Saronno (VA), Italia
Tel: +39 02 9628 0333
Fax: +39 02 9625 570
Email: nexcomitalia@nexcom.eu
www.nexcomitalia.it

Package Contents

Before continuing, verify that the package you received is complete. Your IPPC series package should have all the items listed in the table.

IPPC A1570TE2-DC/IPPC A1770TE2-DC/IPPC A1970TE2-DC

Item	Description	Qty
1	3-pin terminal block for DC power input	1
2	3-pin terminal block for remote power switch	1
3	CPU thermal pad	1
4	PS/2 Y cable	1
5	Driver CD	1
6	Screws for HDD/SSD	4
7	Plastic screw fixing kit for PCI/PCIe card	2
8	Resistive touch pen	1

IPPC A1570PE2-DC/IPPC 1670PE2/IPPC A1770PE2-DC IPPC A1970PE2-DC/IPPC 2170PE2

Item	Description	Qty
1	3-pin terminal block for DC power input	1
2	3-pin terminal block for remote power switch	1
3	CPU thermal pad	1
4	PS/2 Y cable	1
5	Driver CD	1
6	Screws for HDD/SSD	4
7	Plastic screw fixing kit for PCI/PCIe card	2

IPPC A1770TE2-AC

Item	Description	Qty
1	3-pin terminal block for remote power switch	1
2	CPU thermal pad	1
3	PS/2 Y cable	1
4	Driver CD	1
5	Screws for HDD/SSD	8
6	Plastic screw fixing kit for PCI/PCIe card	2
7	Resistive touch pen	1

IPPC A1770PE2-AC

Item	Description	Qty
1	3-pin terminal block for remote power switch	1
2	CPU thermal pad	1
3	PS/2 Y cable	1
4	Driver CD	1
5	Screws for HDD/SSD	8
6	Plastic screw fixing kit for PCI/PCIe card	2

IPPC A1770TFE2-DC

Item	Description	Qty
1	3-pin terminal block for DC power input	1
2	3-pin terminal block for remote power switch	1
3	PS/2 Y cable	1
4	Driver CD	1
5	Screws for HDD/SSD	4
6	Plastic screw fixing kit for PCI/PCIe card	2
7	Resistive touch pen	1

1. 3-pin terminal block for DC power input (P/N: 4NCPF00310X00)



2. 3-pin terminal block for remote power switch (P/N: 4NCPF00310X00)



3. CPU thermal pad (P/N: 5060200113X00)



4. PS/2 Y cable (P/N: 60233MK202X00)



5. Driver CD (P/N: 602DCD1175X00)



6. Screws for HDD/SSD (P/N: 50311F0326X00)



IPPC A1770TE2-DC/IPPC A1770PE2-DC
IPPC A1770TFE2-DC
IPPC A1970TE2-DC/IPPC A1970PE2-DC

IPPC A1770TE2-AC/IPPC A1770PE2-AC

7. Plastic screw fixing kit for PCI/PCle card (P/N: 50311P0001X00 and 50322P0002X00)



8. Resistive touch pen (P/N: 5070000020X00)



Note: Package contents may vary depending on your country region. Some items may be optional. Please contact your local distributor for more information.

Ordering Information

The following provides ordering information for the Industrial Panel PC series.

- **IPPC A1570TE2-DC (P/N: 10II1570T00X0)**

15" XGA LED backlight fanless RTP touch panel PC, 2x COM, DC power input, and optional fieldbus module

- **IPPC A1570PE2-DC (P/N: 10II1570P00X0)**

15" XGA LED backlight fanless P_CAP touch panel PC, 2x COM, DC power input, and optional fieldbus module

- **IPPC 1670PE2-DC (P/N: 10II1670P00X0)**

15.6" WXGA LED backlight fanless P_CAP touch panel PC, 2x COM, DC power input, and optional fieldbus module

- **IPPC A1770TE2-DC (P/N: 10II1770T00X0)**

17" SXGA LED backlight fanless RTP touch panel PC, 2x COM, DC power input, and optional fieldbus module

- **IPPC A1770PE2-DC (P/N: 10II1770P00X0)**

17" SXGA LED backlight fanless P-CAP touch panel PC, 2x COM, DC power input, and optional fieldbus module

- **IPPC A1770TE2-AC (P/N: 10II1770T01X0)**

17" SXGA LED backlight fanless RTP touch panel PC, 2x COM, AC power input, and optional fieldbus module

- **IPPC A1770PE2-AC (P/N: 10II1770P01X0)**

17" SXGA LED backlight fanless P-CAP touch panel PC, 2x COM, AC power input, and optional fieldbus module

- **IPPC A1770TFE2-DC (P/N:10II1770T02X0)**

17" SXGA LED backlight w/fan RTP touch panel PC, 2x COM, DC power input, and optional fieldbus module

- **IPPC A1970TE2-DC (P/N:10II0197001X0)**

19" SXGA LED backlight fanless RTP touch panel PC, 2x COM, DC power input, and optional fieldbus module

- **IPPC A1970PE2-DC (P/N:10II0197000X0)**

19" SXGA LED backlight fanless P-CAP touch panel PC, 2x COM, DC power input, and optional fieldbus module

- **IPPC 2170PE2-DC (P/N: 10II2170P00X0)**

21.5" Full HD LED backlight fanless P_CAP touch panel PC, 2x COM, DC power input, and optional fieldbus module

CHAPTER 1: PRODUCT INTRODUCTION

IPPC A1570T/P Series

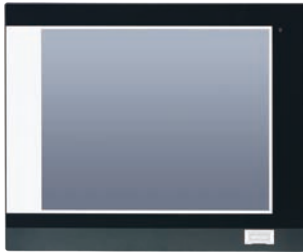

IPPC A1570T/P

Key Features

- 4:3 15" XGA Fanless Panel Computer
- Powerful 4th generation Intel® Core™ processor
- Two expansion slots for add-on PCI or/and PCIe cards
- Optional 3.5G/Wi-Fi module/2.5" HDD/2 x COM/GPIO/DIO/Dimming Control Button
- Front accessible USB 2.0 for easy of field maintenance
- Inside USB 3.0 type A connector for license key
- Metal housing with robust aluminum IP66 compliant front bezel for harsh environment
- Two FBI ports support fieldbus module
- Wide range 12V~30VDC power input for -DC model

Specifications

Panel

- LED Size: 15", 4:3
- Resolution: XGA 1024 x 768
- Luminance: 450cd/m²
- Contrast ratio: 800
- LCD color: 16.2M
- Viewing angle: 70 (U), 80 (D), 80 (L), 80 (R)
- Backlight: LED

Touch

For IPPC A1570T Series

- 5-wire resistive (flush panel type)
- Light transmission: 81%
- Interface: USB

For IPPC A1570P Series

- Five Points P-Cap (projected capacitive touch)
- Light transmission: 87%
- Interface: USB
- Anti-scratch surface: >= 6H hardness

System

- CPU (optional): support 4th gen. Intel® Core™ processor family, LGA1150 socket type
 - Core™ i5-4590T, Quad Core, 2.0GHz, 6M Cache (maximum frequency 3.0GHz if turbo boost enabled)
 - Core™ i5-4570TE, Dual Core, 2.7GHz, 4M Cache (maximum frequency 3.3GHz if turbo boost enabled)
 - Core™ i3-4350T, Dual Core, 3.1GHz, 4M Cache (no turbo boost)
 - Core™ i3-4340TE, Dual Core, 2.6GHz, 4M Cache (no turbo boost)

- Pentium® G3320TE, Dual Core, 2.3GHz, 3M Cache (no turbo boost)
- Celeron® G1820TE, Dual Core, 2.2GHz, 2M Cache (no turbo boost)
- BIOS: AMI BIOS
- System chipset: Intel® Q87 PCH
- System memory (optional): 2x 204-pin DDR3/DDR3L SO-DIMM socket, support up to 16GB DDR3/DDR3L 1333/1600, non-ECC and unbuffered
- Storage device:
 - 1x external locked CFast socket
 - 1x mini-PCIe w/o SIM card holder slot to support mSATA storage
 - 1x hard drive bay: support 1x 2.5" SATA HDD/SSD (optional)
- Watchdog timer: Watchdog timeout can be programmed by software from 1 second to 255 seconds and from 1 minute to 255 minutes (tolerance 15% under room temperature 25°C)
- H/W status monitor: monitoring system temperature and voltage
- Expansion:
 - 2x mini-PCIe sockets (support optional Wi-Fi or 3.5G module/NVRAM/mSATA storage)
 - 2x expansion slots for add-on PCI or/and PCIe cards
 - 1x PCI and 1x PCIe x4 slots
 - 2x PCIe x4 slots (default)
 - 2x PCI slots
 - 1x PCIe x16 slot
- 1x Front accessible USB 2.0

Rear I/O

- 1x PS2 for keyboard/mouse
- Ethernet: 2x RJ45
- 2nd/3rd display: additional independent DisplayPort: 1x DVI-I (DVI-D + DVI-A) and 1x DisplayPort
- Audio port: 1x Line-out; 1x Line-in; 1x Mic-in

- USB: 4x USB 3.0
- 3-pin remote power on/off switch connector
- Reset button
- COM#1: RS232/422/485 w/ 5V or 12V selection
- ATX power switch

Top I/O

- COM#2 RS232/422/485 w/ 5V or 12V selection

Audio

- HD codec: Realtek ALC886-GR
- Audio interface: Line-out/Line-in/Mic-in audio jack

Ethernet

- LAN chip: dual Intel® I210IT Gigabit LAN
- Ethernet interface: 10/100/1000 Base-Tx Ethernet compatible

Fieldbus

- Support up to two Fieldbus modules

Mechanical & Environment

- Color: Pantone 432C\RAL 70 24 front bezel
- Enclosure: aluminum front bezel with SPPC nickel plated housing
- IP protection: IP66 front
- Mounting: panel/wall/stand/VESA 100mm x 100mm
- Power:
 - Power input: 12~30 VDC
 - Power connector: 3-pin PHOENIX connector
- Vibration:
 - IEC 68 2-64 (w/ HDD)

- 1Grms @ sine, 5~500Hz, 1hr/axis (HDD operating)
- 2Grms @ sine, 5~500Hz, 1hr/axis (CFast operating)
- 2.2Grms @ random condition, 5~500Hz, 0.5hr/axis (non-operating)
- Shock:
 - IEC 68 2-27
 - HDD: 20G @ wall mount, half sine, 11ms
- Operating temperature
 - Resistive: -10°C to 50°C
 - P-Cap: -20°C to 50°C
- Storage temperature: -20°C to 75°C
- Operating humidity: 10%~90% relative humidity, non-condensing (for IPPC A1570T series, limits to be at 90% RH at max 50°C)
- Dimension: 400 x 330 x 104.9 mm
- Weight: (barebone)
 - IPPC A1570TE2-DC: 8.99kg
 - IPPC A1570PE2-DC: 9.08kg

Certifications

- CE (including EN61000-6-2/EN61000-6-4), FCC Class A

OS Support Lists

- Windows 7 32-bit and 64-bit
- Windows 8.1 32-bit and 64-bit

IPPC 1670P

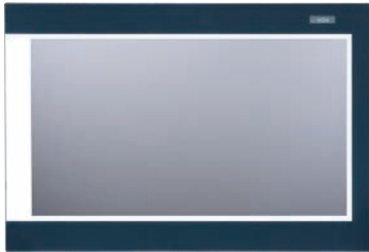

IPPC 1670P

Key Features

- 16:9 15.6" WXGA Fanless Panel Computer
- Powerful 4th generation Intel® Core™ processor
- Two expansion slots for add-on PCI or/and PCIe cards
- Optional 3.5G/Wi-Fi module/2.5" HDD/2 x COM/GPIO/DIO/Dimming Control Button
- Front accessible USB 2.0 for easy of field maintenance
- Inside USB 3.0 type A connector for license key
- Metal housing with robust aluminum IP66 compliant front bezel for harsh environment
- Two FBI ports support fieldbus module
- Wide range 12V~30VDC power input for -DC model

Specifications

Panel

- LCD size: 15.6", 16:9
- Resolution: WXGA, 1366 x 768
- Luminance: 300cd/m²
- Contrast ratio: 500
- LCD color: 16.7M
- Viewing angle: 80 (U), 80 (D), 85 (L), 85 (R)
- Backlight: LED

Touch (for IPPC 1670P Series)

- Ten points P-Cap (projected capacitive touch)
- Light transmission: 87%
- Interface: USB
- Anti-scratch surface: >= 6H hardness

System

- CPU (optional): support 4th gen. Intel® Core™ processor family, LGA1150 socket type
 - Core™ i5-4590T, Quad Core, 2.0GHz, 6M Cache (maximum frequency 3.0GHz if turbo boost enabled)
 - Core™ i5-4570TE, Dual Core, 2.7GHz, 4M Cache (maximum frequency 3.3GHz if turbo boost enabled)
 - Core™ i3-4350T, Dual Core, 3.1GHz, 4M Cache (no turbo boost)
 - Core™ i3-4340TE, Dual, Core, 2.6GHz, 4M Cache (no turbo boost)
 - Pentium® G3320TE, Dual Core, 2.3GHz, 3M Cache (no turbo boost)
 - Celeron® G1820TE, Dual Core, 2.2GHz, 2M Cache (no turbo boost)
- BIOS: AMI BIOS
- System chipset: Intel® Q87 PCH

- System memory (optional): 2x 204-pin DDR3/DDR3L SO-DIMM socket, support up to 16GB DDR3/DDR3L 1333/1600, non-ECC and unbuffered
- Storage device:
 - 1x External locked CFast socket
 - 1x mini-PCIe w/o SIM card holder slot to support mSATA storage
 - 1x Hard drive bay: support 1x 2.5" SATA HDD/SSD (optional) (for DC model only)
- Watchdog timer: Watchdog timeout can be programmed by software from 1 second to 255 seconds and from 1 minute to 255 minutes (tolerance 15% under room temperature 25°C)
- H/W status monitor: monitoring system temperature and voltage
- Expansion:
 - 2x mini-PCIe sockets (support optional Wi-Fi or 3.5G module/NVRAM/mSATA storage)
 - 2x expansion slots for add-on PCI or/and PCIe cards
 - 1x PCI and 1x PCIe x4 slots
 - 2x PCIe x4 slots (default)
 - 2x PCI slots
 - 1x PCIe x16 slot

Rear I/O

- 1x PS2 for keyboard/mouse
- Ethernet: 2x RJ45
- 2nd/3rd display: additional independent DisplayPort: 1x DVI-I (DVI-D + DVI-A) and 1x DisplayPort
- Audio port: 1x Line-out; 1x Line-in; 1x Mlic-in
- USB: 4x USB3.0
- 3-pin remote power on/off switch connector

- Reset button
- COM#1: RS232/422/485 w/ 5V or 12V selection (for T/P-DC only)
- ATX power switch (for T/P-DC only)

Top I/O

- COM#2 RS232/422/485 w/ 5V or 12V selection (for T/P-DC only)

Audio

- HD codec: Realtek ALC886-GR
- Audio interface: Line-out/Line-in/Mic-in audio jack

Ethernet

- LAN chip: dual Intel® I210IT Gigabit LAN
- Ethernet interface: 10/100/1000 Base-Tx Ethernet compatible

Fieldbus

- Support up to two Fieldbus modules

Mechanical & Environment

- Color: Pantone 432C\RAL 70 24 front bezel
- Enclosure: aluminum front bezel with SPPC nickel plated housing
- IP protection: IP66 front
- Mounting: panel/wall/stand/VESA 100mm x 100mm
- Power: IPPC 1670P
 - Power input: 12~30 VDC
 - Power connector: 3-pin PHOENIX connector
- Vibration:
 - IEC 68 2-64 (w/ HDD)
 - 1Grms @ sine, 5~500Hz, 1hr/axis (HDD operating)
 - 2Grms @ sine, 5~500Hz, 1hr/axis (CFast operating)
 - 2.2Grms @ random condition, 5~500Hz, 0.5hr/axis (non-operating)

- Shock:
 - IEC 68 2-27
 - HDD: 20G @ wall mount, half sine, 11ms
- Operating temperature:
 - Resistive: -10°C to 50°C
 - P-Cap: -10°C to 50°C
 - Storage temperature: -20°C to 75°C
 - Operating humidity: 10%~90% relative humidity, non-condensing (for IPPC 1670P series, limits to be at 90% RH at max 50°C)

Dimension

- 417.4 x 312.4 x 105.95mm
- Weight: (barebone): 9.18kg

Certifications

- CE (including EN61000-6-2/EN61000-6-4), FCC Class A

OS Support Lists

- Windows 7 32-bit and 64-bit
- Windows 8.1 32-bit and 64-bit
- Windows 10 32-bit and 64-bit

IPPC A1770T/P Series

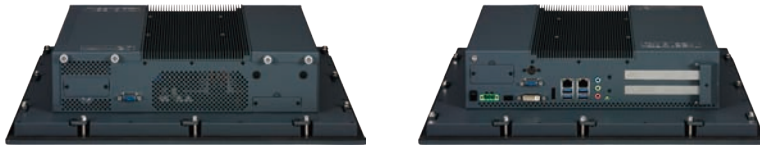
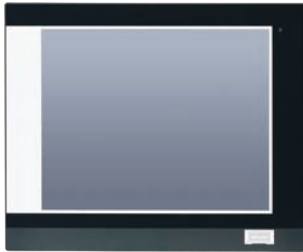

IPPC A1770T/P-DC



IPPC A1770T/P-AC



IPPC A1770TF-DC

Key Features

- 4:3 17" SXGA Fanless & Fan Panel Computer
- Powerful 4th generation Intel® Core™ processor
- Two expansion slots for add-on PCI or/and PCIe cards
- Optional 3.5G/Wi-Fi module/2.5" HDD/2 x COM/GPIO/DIO/Dimming Control Button
- Front accessible USB 2.0 for easy of field maintenance
- Inside USB 3.0 type A connector for license key
- Metal housing with robust aluminum IP66 compliant front bezel for harsh environment
- Two FBI ports support fieldbus module
- Wide range 12V~30VDC power input for -DC model
- Wide range 100V~240VAC power input for -AC model

Specifications

Panel

- LED Size: 17", 4:3
- Resolution: SXGA 1280 x 1024
- Luminance: 350cd/m²
- Contrast ratio: 1000
- LCD color: 16.7M
- Viewing angle: 80 (U), 80 (D), 85 (L), 85 (R)
- Backlight: LED

Touch

For IPPC A1770T Series

- 5-wire resistive (flush panel type)
- Light transmission: 81%
- Interface: USB

For IPPC A1770P Series

- Five Points P-Cap (Projected Capacitive Touch)
- Light transmission: 87%
- Interface: USB
- Anti-scratch surface: 7H hardness

System

- CPU (optional): support 4th gen. Intel® Core™ processor family, LGA1150 socket type
 - Core™ i7-4770TE, Quad Core, 2.3GHz, 8M Cache (IPPC A1770TF-DC model only)
 - Core™ i7-4785T, Quad Core, 2.2GHz, 8M Cache (IPPC A1770TF-DC model only)
 - Core™ i5-4590T, Quad Core, 2GHz, 6M Cache

- Core™ i5-4570TE, Dual Core, 2.7GHz, 4M Cache
- Core™ i3-4350T, Dual Core, 3.1GHz, 4M Cache
- Core™ i3-4340TE, Dual Core, 2.6GHz, 4M Cache
- Pentium® G3320TE, Dual Core, 2.3GHz, 3M Cache
- Celeron® G1820TE, Dual Core, 2.2GHz, 2M Cache
- BIOS: AMI BIOS
- System chipset: Intel® Q87 PCH
- System memory (optional): 2x 204-pin DDR3/DDR3L SO-DIMM socket, support up to 16GB DDR3/DDR3L 1333/1600, non-ECC and unbuffered
- Storage device:
 - 1x external locked CFast socket
 - 1x mini-PCIe w/o SIM card holder slot to support mSATA storage
 - 1x hard drive bay: support 1x 2.5" SATA HDD/SSD (optional) (for DC model only)
 - 2x hard drive bays: support 2x 2.5" SATA HDD/SSD (optional) RAID 0, 1 (for AC model only)
- Watchdog timer: Watchdog timeout can be programmed by software from 1 second to 255 seconds and from 1 minute to 255 minutes (tolerance 15% under room temperature 25°C)
- H/W status monitor: monitoring system temperature and voltage
- Expansion:
 - 2x mini-PCIe sockets (support optional Wi-Fi or 3.5G module/NVRAM/mSATA storage)
 - 2x expansion slots for add-on PCI or/and PCIe cards
 - 1x PCI and 1x PCIe x4 slots
 - 2x PCIe x4 slots (default)
 - 2x PCI slots
 - 1x PCIe x16 slot
- Panel backlight control button: increase brightness/decrease brightness/backlight on/off (for AC model only)

Rear I/O

For All

- 1x PS2 for keyboard/mouse
- Ethernet: 2x RJ45
- 2nd/3rd display: Additional independent DisplayPort: 1x DVI-I and 1x DisplayPort
- Audio port: 1x Line-out; 1x Line-in; 1x Mic-in
- USB: 4x USB3.0
- 3-pin remote power on/off switch connector
- Reset button

For IPPC A1770T/P-DC only

- COM#1: RS232/422/485 w/ 5V or 12V selection
- ATX power switch

For IPPC A1770T/P-AC only

- COM#1: RS232/422/485 w/ 2.5kv isolated protection
- AC power switch

Top I/O

For IPPC A1770T/P-DC only

- COM#2 RS232/422/485 w/ 5V or 12V selection

For IPPC A1770T/P-AC only

- COM#2: RS232/422/485 w/ 2.5kv isolated protection
- DIO w/ 2.5kv isolated protection:
 - 4x digital input (source type)
 - Input voltage (dry contact): Logic 0: Close to GND, Logic 1: Open
 - Input voltage: Logic 0: 3V max., Logic 1: +5 to 30V
 - 4x digital output (Sink type)
 - Output voltage: +3.6 to 5V
 - Sink current: 200mA max. per channel
- GPIO: 4x Digital In/4x Digital Out

Audio

- HD Codec: Realtek ALC886-GR
- Audio interface: Line-out/Line-in/Mic-in audio jack

Ethernet

- LAN chip: dual Intel® I210IT Gigabit LAN
- Ethernet interface: 10/100/1000 Based-Tx Ethernet compatible

Fieldbus

- Support up to two Fieldbus modules

Mechanical & Environment

- Color: pantone 432C\ RAL 70 24 front bezel
- Enclosure: aluminum front bezel with SPPC nickel plated housing
- IP protection: IP66 front
- Mounting: panel/wall/stand/VESA 100mm x 100mm
- Power

IPPC A1770TE2-DC/IPPC A1770PE2-DC/IPPC A1770TFE2-DC

- Power input: 12~30 VDC
- Power connector: 3-pin PHOENIX connector

IPPC A1770TE2-AC/IPPC A1770PE2-AC

- Power input: 100-240V~, 1.5A, 50-60Hz; Fuse: 250VAC/3A
- Power connector: AC inlet (IEC60320 C14)
- Power supply: 120W

Vibration:

- IEC 68 2-64 (w/ HDD)
 - 1Grms @ sine, 5~500Hz, 1hr/axis (HDD operating)
 - 2Grms @ sine, 5~500Hz, 1hr/axis (CFast operating)
 - 2.2Grms @ random condition, 5~500Hz, 0.5hr/axis (non-operating)

- Shock:
 - IEC 68 2-27
 - HDD: 20G @ wall mount, half sine, 11ms
- Operating temperature:
 - Resistive: -10°C to 50°C
 - P-Cap: -20°C to 50°C
- Storage temperature: -20°C to 75°C
- Operating humidity: 10%~90% relative humidity, non-condensing
- Dimension:
 - IPPC A1770TE2-DC/IPPC A1770PE2-DC/IPPC A1770TFE2-DC:
451mm x 375.5mm x 105mm
 - IPPC A1770TE2-AC/IPPC A1770PE2-AC:
451mm x 375.5mm x 92.9mm
- Weight: (Barebone)
 - IPPC A1770TE2-DC: 9.54kg
 - IPPC A1770PE2-DC: 9.6kg
 - IPPC A1770TE2-AC: 10.45kg
 - IPPC A1770PE2-AC: 10.51kg
 - IPPC A1770TFE2-DC: 9.015kg

Certifications

- CE (including EN61000-6-2/EN61000-6-4)
- FCC Class A

OS Support Lists

- Windows 7 32-bit and 64-bit
- Windows 8.1 32-bit and 64-bit

IPPC A1970T/P Series

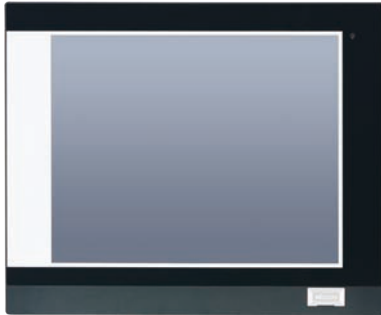

IPPC A1970T/P-DC

Key Features

- 4:3 19" SXGA Fanless Panel Computer
- Powerful 4th generation Intel® Core™ processor
- Two expansion slots for add-on PCI or/and PCIe cards
- Optional 3.5G/Wi-Fi module/2.5" HDD/2 x COM/GPIO/DIO/Dimming Control Button
- Front accessible USB 2.0 for easy of field maintenance
- Inside USB 3.0 type A connector for license key
- Metal housing with robust aluminum IP66 compliant front bezel for harsh environment
- Two FBI ports support fieldbus module
- Wide range 12V~30VDC power input

Specifications

Panel

- LED Size: 19", 4:3
- Resolution: SXGA 1280 x 1024
- Luminance: 350cd/m²
- Contrast ratio: 1000
- LCD color: 16.7M
- Viewing angle: 80 (U), 80 (D), 85 (L), 85 (R)
- Backlight: LED

Touch

For IPPC A1970T Series

- 5-wire resistive (flush panel type)
- Light transmission: 80±3%
- Interface: USB

For IPPC A1970P Series

- Ten Points P-Cap (Projected Capacitive Touch)
- Light transmission: 87±2%
- Interface: USB
- Anti-scratch surface: >= 6H hardness

System

- CPU (optional): support 4th gen. Intel® Core™ processor family, LGA1150 socket type
 - Core™ i5-4590T, Quad Core, 2GHz, 6M Cache
 - Core™ i5-4570TE, Dual Core, 2.7GHz, 4M Cache
 - Core™ i3-4350T, Dual Core, 3.1GHz, 4M Cache
 - Core™ i3-4340TE, Dual Core, 2.6GHz, 4M Cache
 - Pentium® G3320TE, Dual Core, 2.3GHz, 3M Cache
 - Celeron® G1820TE, Dual Core, 2.2GHz, 2M Cache

- BIOS: AMI BIOS
- System chipset: Intel® Q87 PCH
- System memory (optional): 2x 204-pin DDR3/DDR3L SO-DIMM socket, support up to 16GB DDR3/ DDR3L 1333/1600, non-ECC and unbuffered
- Storage device:
 - 1x external locked CFast socket
 - 1x mini-PCIe w/o SIM card holder slot to support mSATA storage
 - 1x hard drive bay: support 1x 2.5" SATA HDD/SSD (optional) (for DC model only)
 - 2x hard drive bays: support 2x 2.5" SATA HDD/SSD (optional) RAID 0, 1 (for AC model only)
- Watchdog timer: Watchdog timeout can be programmed by software from 1 second to 255 seconds and from 1 minute to 255 minutes (tolerance 15% under room temperature 25°C)
- H/W status monitor: monitoring system temperature and voltage
- Expansion:
 - 2x mini-PCIe sockets (support optional Wi-Fi or 3.5G module/NVRAM/ mSATA storage)
 - 2x expansion slots for add-on PCI or/and PCIe cards
 - 1x PCI and 1x PCIe x4 slots
 - 2x PCIe x4 slots (default)
 - 2x PCI slots
 - 1x PCIe x16 slot
- 1x Front accessible USB 2.0

Rear I/O

- 1x PS2 for keyboard/mouse
- Ethernet: 2x RJ45
- 2nd/3rd display: Additional independent DisplayPort: 1x DVI-I (DVI-D + DVI-A) and 1x DisplayPort

Rear I/O

- Audio port: 1x Line-out; 1x Line-in; 1x Mic-in
- USB: 4x USB3.0
- 3-pin remote power on/off switch connector
- Reset button
- COM#1: RS232/422/485 w/ 5V or 12V selection
- ATX power switch

Top I/O

- COM#2 RS232/422/485 w/ 5V or 12V selection

Audio

- HD Codec: Realtek ALC886-GR
- Audio interface: Line-out/Line-in/Mic-in audio jack

Ethernet

- LAN chip: dual Intel® I210IT Gigabit LAN
- Ethernet interface: 10/100/1000 Based-Tx Ethernet compatible

Fieldbus

- Support up to two Fieldbus modules

Mechanical & Environment

- Color: pantone 432C\ RAL 70 24 front bezel
- Enclosure: aluminum front bezel with SPPC nickel plated housing
- IP protection: IP66 front
- Mounting: panel/wall/stand/VESA 100mm x 100mm
- Power:
 - Power input: 12~30 VDC
 - Power connector: 3-pin PHOENIX connector

- Vibration:
 - IEC 68 2-64 (w/ HDD)
 - 1Grms @ sine, 5~500Hz, 1hr/axis (HDD operating)
 - 2Grms @ sine, 5~500Hz, 1hr/axis (CFast operating)
 - 2.2Grms @ random condition, 5~500Hz, 0.5hr/axis (non-operating)
- Shock:
 - IEC 68 2-27
 - HDD: 20G @ wall mount, half sine, 11ms
- Operating temperature:
 - Resistive: -10°C to 50°C
 - P-Cap: -20°C to 50°C
- Storage temperature: -20°C to 75°C
- Operating humidity: 10%~90% relative humidity, non-condensing (for IPPC A1970T series, limits to be at 90% RH at max 50°C)
- Dimension: 470 x 400 x 104.9 mm
- Weight: (Barebone)
 - IPPC A1970TE2-DC: 10.25kg
 - IPPC A1970PE2-DC: 10.34kg

Certifications

- CE (including EN61000-6-2/EN61000-6-4)
- FCC Class A

OS Support Lists

- Windows 7 32-bit and 64-bit
- Windows 8.1 32-bit and 64-bit

IPPC 2170P-DC

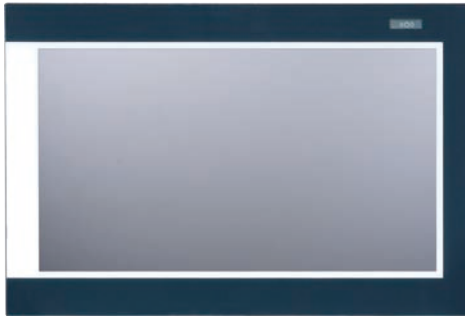

IPPC 2170P-DC

Key Features

- 16:9 21.5" Full HD Fanless Panel Computer
- Powerful 4th generation Intel® Core™ processor
- Two expansion slots for add-on PCI or/and PCIe cards
- Optional 3.5G/Wi-Fi module/2.5" HDD/2 x COM/GPIO/DIO/Dimming Control Button
- Front accessible USB 2.0 for easy of field maintenance
- Inside USB 3.0 type A connector for license key
- Metal housing with robust aluminum IP66 compliant front bezel for harsh environment
- Two FBI ports support fieldbus module
- Wide range 12V~30VDC power input for -DC model

Specifications

Panel

- LCD size: 21.5", 16:9
- Resolution: Full HD, 1920 x 1080
- Luminance: 300cd/m²
- Contrast ratio: 5000
- LCD color: 16.7M
- Viewing angle: 89 (U), 89 (D), 89 (L), 89 (R)
- Backlight: LED

Touch (for IPPC 2170P Series)

- Ten points P-Cap (projected capacitive touch)
- Light transmission: 87%
- Interface: USB
- Anti-scratch surface: >= 6H hardness

System

- CPU (optional): support 4th gen. Intel® Core™ processor family, LGA1150 socket type
 - Core™ i5-4590T, Quad Core, 2.0GHz, 6M Cache (maximum frequency 3.0GHz if turbo boost enabled)
 - Core™ i5-4570TE, Dual Core, 2.7GHz, 4M Cache (maximum frequency 3.3GHz if turbo boost enabled)
 - Core™ i3-4350T, Dual Core, 3.1GHz, 4M Cache (no turbo boost)
 - Core™ i3-4340TE, Dual, Core, 2.6GHz, 4M Cache (no turbo boost)
 - Pentium® G3320TE, Dual Core, 2.3GHz, 3M Cache (no turbo boost)
 - Celeron® G1820TE, Dual Core, 2.2GHz, 2M Cache (no turbo boost)
- BIOS: AMI BIOS
- System chipset: Intel® Q87 PCH

- System memory (optional): 2x 204-pin DDR3/DDR3L SO-DIMM socket, support up to 16GB DDR3/DDR3L 1333/1600, non-ECC and unbuffered
- Storage device:
 - 1x External locked CFast socket
 - 1x mini-PCIe w/o SIM card holder slot to support mSATA storage
 - 1x Hard drive bay: support 1x 2.5" SATA HDD/SSD (optional) (for DC model only)
- Watchdog timer: Watchdog timeout can be programmed by software from 1 second to 255 seconds and from 1 minute to 255 minutes (tolerance 15% under room temperature 25°C)
- H/W status monitor: monitoring system temperature and voltage
- Expansion:
 - 2x mini-PCIe sockets (support optional Wi-Fi or 3.5G module/NVRAM/mSATA storage)
 - 2x expansion slots for add-on PCI or/and PCIe cards
 - 1x PCI and 1x PCIe x4 slots
 - 2x PCIe x4 slots (default)
 - 2x PCI slots
 - 1x PCIe x16 slot

Rear I/O

- 1x PS2 for keyboard/mouse
- Ethernet: 2x RJ45
- 2nd/3rd display: additional independent DisplayPort: 1x DVI-I (DVI-D + DVI-A) and 1x DisplayPort
- Audio port: 1x Line-out; 1x Line-in; 1x Mic-in
- USB: 4x USB3.0
- 3-pin remote power on/off switch connector

- Reset button
- COM#1: RS232/422/485 w/ 5V or 12V selection (for T/P-DC only)
- ATX power switch (for T/P-DC only)

Top I/O

- COM#2 RS232/422/485 w/ 5V or 12V selection (for T/P-DC only)

Audio

- HD codec: Realtek ALC886-GR
- Audio interface: Line-out/Line-in/Mic-in audio jack

Ethernet

- LAN chip: dual Intel® I210IT Gigabit LAN
- Ethernet interface: 10/100/1000 Base-Tx Ethernet compatible

Fieldbus

- Support up to two Fieldbus modules

Mechanical & Environment

- Color: Pantone 432C\RAL 70 24 front bezel
- Enclosure: aluminum front bezel with SPPC nickel plated housing
- IP protection: IP66 front
- Mounting: panel/wall/stand/VESA 100mm x 100mm
- Power: IPPC 2170P
 - Power input: 12~30 VDC
 - Power connector: 3-pin PHOENIX connector
- Vibration:
 - IEC 68 2-64 (w/ HDD)
 - 1Grms @ sine, 5~500Hz, 1hr/axis (HDD operating)
 - 2Grms @ sine, 5~500Hz, 1hr/axis (CFast operating)
 - 2.2Grms @ random condition, 5~500Hz, 0.5hr/axis (non-operating)

- Shock:
 - IEC 68 2-27
 - HDD: 20G @ wall mount, half sine, 11ms
- Operating temperature:
 - Resistive: -10°C to 50°C
 - P-Cap: -10°C to 50°C
 - Storage temperature: -20°C to 75°C
 - Operating humidity: 10%~90% relative humidity, non-condensing (for IPPC 2170P series, limits to be at 90% RH at max 50°C)

Dimension

- 562.4 x 382.4 x 105.05mm
- Weight: (barebone): 11.7kg

Certifications

- CE (including EN61000-6-2/EN61000-6-4), FCC Class A

OS Support Lists

- Windows 7 32-bit and 64-bit
- Windows 8.1 32-bit and 64-bit
- Windows 10 32-bit and 64-bit

Knowing Your IPPC A1770T/P Series

IPPC A1770T/P-DC Rear Top

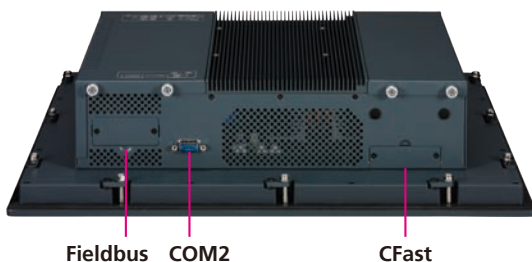

IPPC A1770T/P-DC Rear Bottom

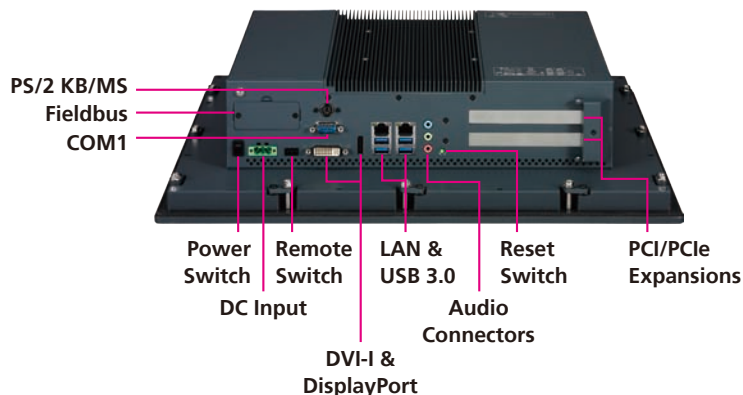

Fieldbus & CFast

Expansion slots for add-on fieldbus modules and CFast cards.

COM1 & COM2

Serial ports with RS232/422/485 support and 5V or 12V selection.

PS/2 KB/MS

Used to connect a PS/2 keyboard and a PS/2 mouse.

Power & Reset Switch

Press to power-on, power-off or restart the system.

Remote Switch

Used to connect a remote to power on/off the system.

DVI-I & DisplayPort

Used to connect display devices.

LAN & USB 3.0

LAN and USB 3.0 ports to connect the system to local area networks and USB devices.

Audio Connectors

Line-in, mic-in and line-out ports used to connect audio devices such as external microphones, speakers and headphones.

PCI/PCIe Expansions

PCI/PCIe expansion slots for add-on cards.

DC Input

Used to plug a DC power cord (terminal block connector).



Please use 12-28 AWG wire size and tighten the terminal block with a torque value of 4.5 lb-in.

IPPC A1770T/P-AC Rear Top

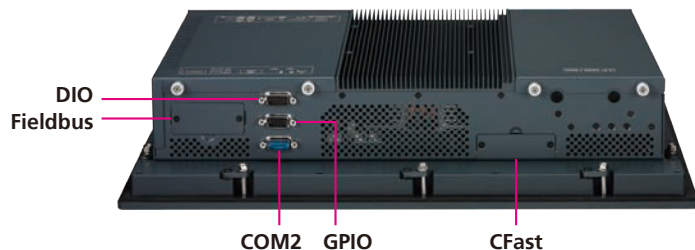

COM1 & COM2

Serial ports with RS232/422/485 support and 2.5kV isolated protection.

GPIO & DIO

The GPIO and DIO connector support 4 digital input and 4 digital output. The DIO connector includes 2.5kV isolated protection.

Fieldbus & CFast

Expansion slots for add-on fieldbus modules and CFast cards.

PS/2 KB/MS

Used to connect a PS/2 keyboard and a PS/2 mouse.

Power & Reset Switch

Press to power-on, power-off or restart the system.

IPPC A1770T/P-AC Rear Bottom

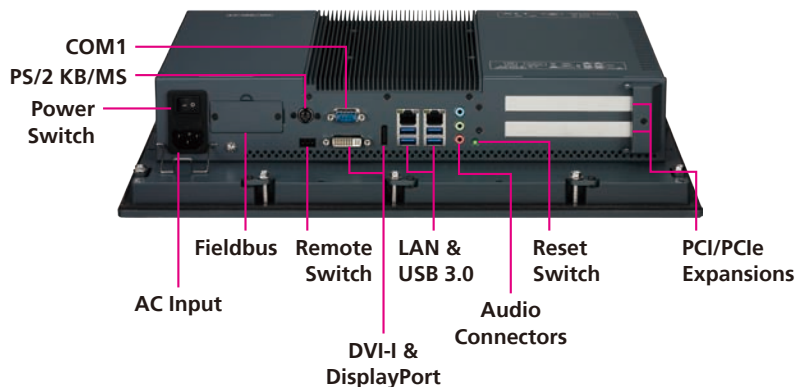

AC Input

Used to plug an AC power cord.

Remote Switch

Used to connect a remote to power on/off the system.

DVI-I & DisplayPort

Used to connect display devices.

LAN & USB 3.0

LAN and USB 3.0 ports to connect the system to local area networks and USB devices.

Audio Connectors

Line-in, mic-in and line-out ports used to connect audio devices such as external microphones, speakers and headphones.

PCI/PCIe Expansions

PCI/PCIe expansion slots for add-on cards.

Knowing Your IPPC A1770TF-DC (Fan Model)

IPPC A1770TFE-DC Rear Top

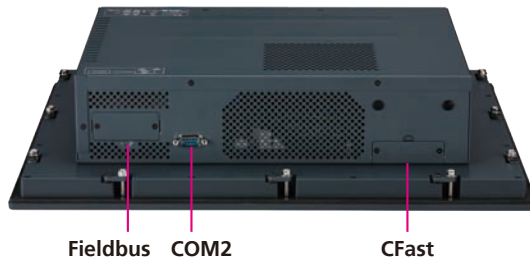

IPPC A1770TFE-DC Rear Bottom

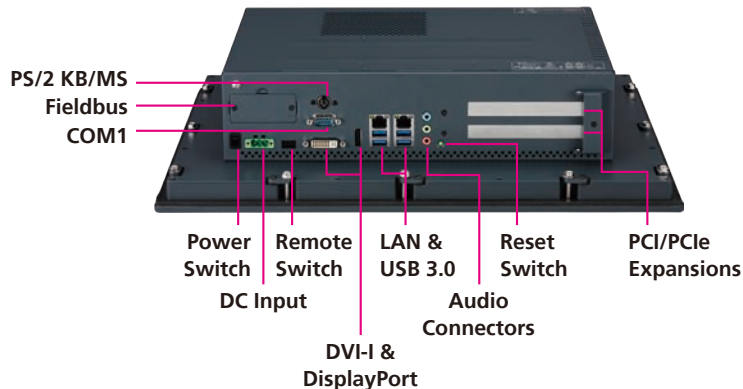

Fieldbus & CFast

Expansion slots for add-on fieldbus modules and CFast cards.

COM1 & COM2

Serial ports with RS232/422/485 support and 5V or 12V selection.

PS/2 KB/MS

Used to connect a PS/2 keyboard and a PS/2 mouse.

Power & Reset Switch

Press to power-on, power-off or restart the system.

Remote Switch

Used to connect a remote to power on/off the system.

DVI-I & DisplayPort

Used to connect display devices.

LAN & USB 3.0

LAN and USB 3.0 ports to connect the system to local area networks and USB devices.

Audio Connectors

Line-in, mic-in and line-out ports used to connect audio devices such as external microphones, speakers and headphones.

PCI/PCle Expansions

PCI/PCle expansion slots for add-on cards.

DC Input

Used to plug a DC power cord (terminal block connector).



Please use 12-28 AWG wire size and tighten the terminal block with a torque value of 4.5 lb-in.

Knowing Your IPPC A1570T/P-DC, IPPC 1670P-DC, IPPC A1970T/P-DC, IPPC 2170P-DC Series

Rear Top

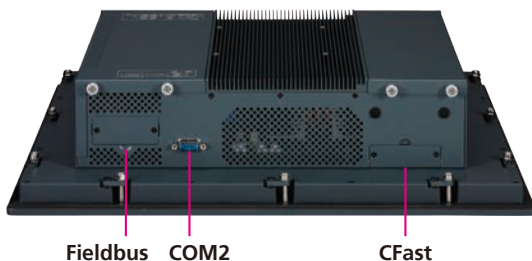

Fieldbus & CFast

Expansion slots for add-on fieldbus modules and CFast cards.

COM1 & COM2

Serial ports with RS232/422/485 support and 5V or 12V selection.

PS/2 KB/MS

Used to connect a PS/2 keyboard and a PS/2 mouse.

Power & Reset Switch

Press to power-on, power-off or restart the system.

Remote Switch

Used to connect a remote to power on/off the system.

DVI-I & DisplayPort

Used to connect display devices.

LAN & USB 3.0

LAN and USB 3.0 ports to connect the system to local area networks and USB devices.

Audio Connectors

Line-in, mic-in and line-out ports used to connect audio devices such as external microphones, speakers and headphones.

PCI/PCIe Expansions

PCI/PCIe expansion slots for add-on cards.

DC Input

Used to plug a DC power cord (terminal block connector).

Rear Bottom

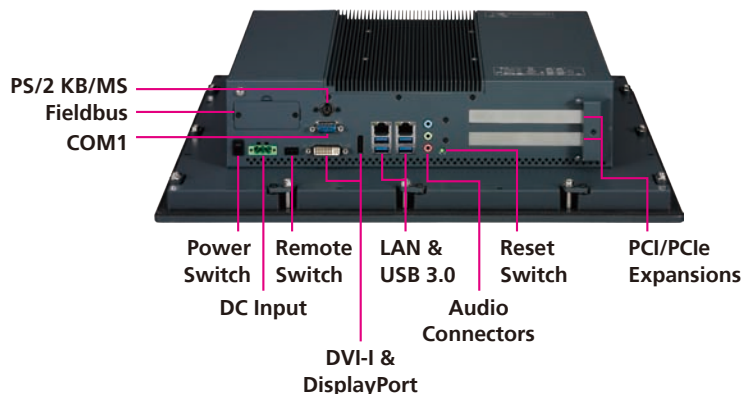

Please use 12-28 AWG wire size and tighten the terminal block with a torque value of 4.5 lb-in.

IPPC A1770TF-DC Rear (Fan Model)

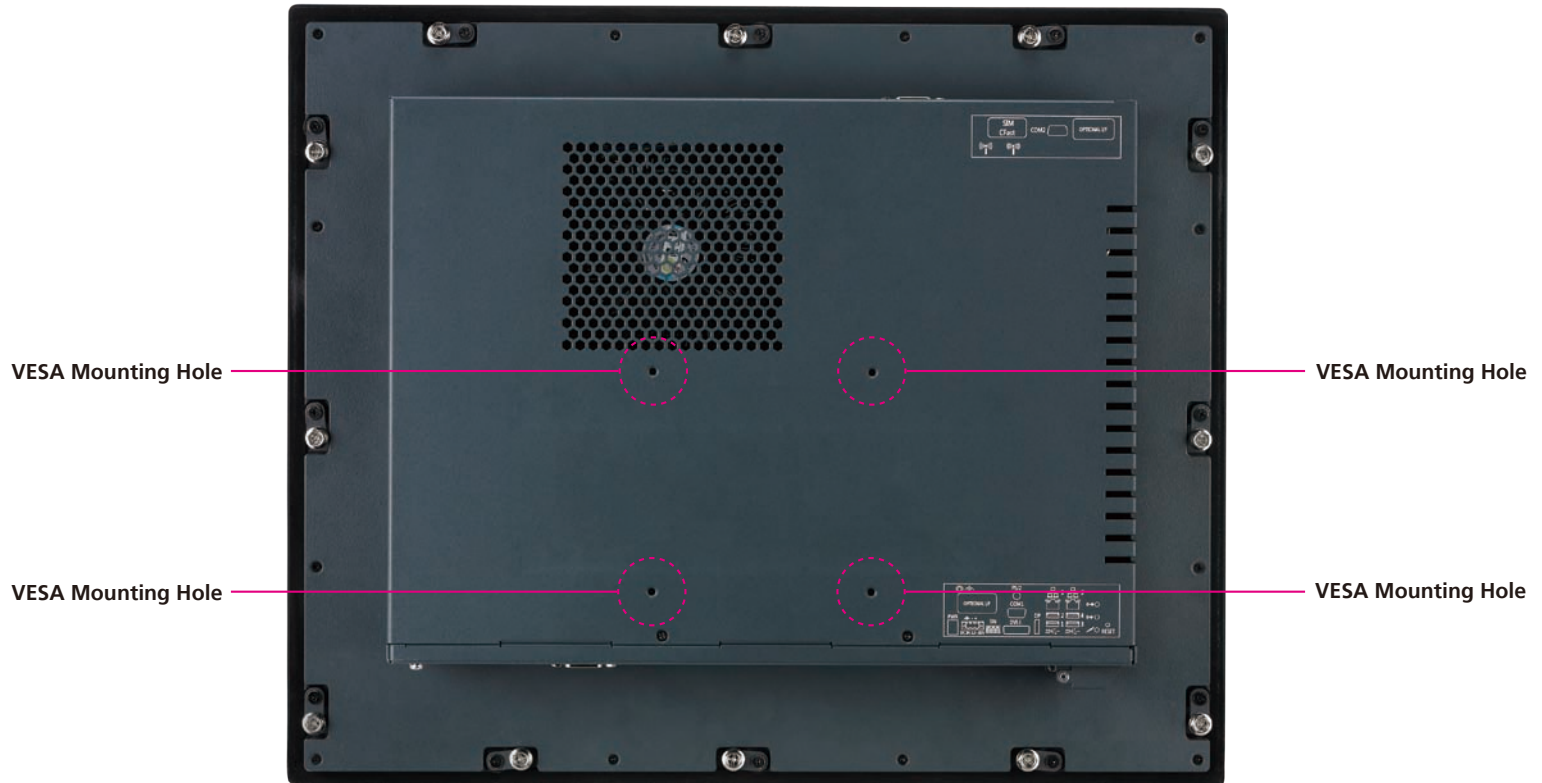

VESA Mounting Holes

These are mounting holes for VESA mount (100x100mm)

IPPC A1770T/P-DC Rear

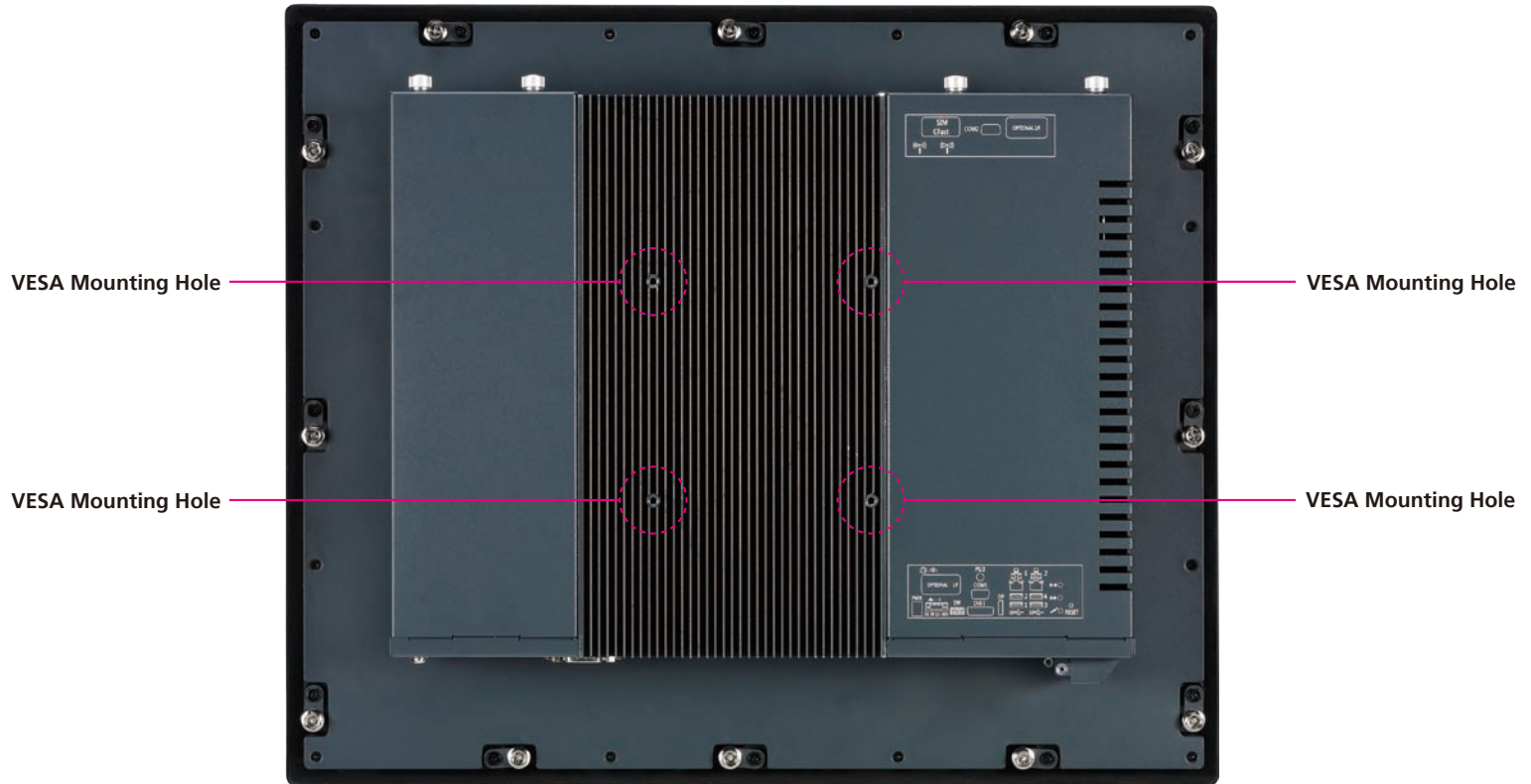

VESA Mounting Holes

These are mounting holes for VESA mount (100x100mm)

IPPC A1770T/P-AC Rear

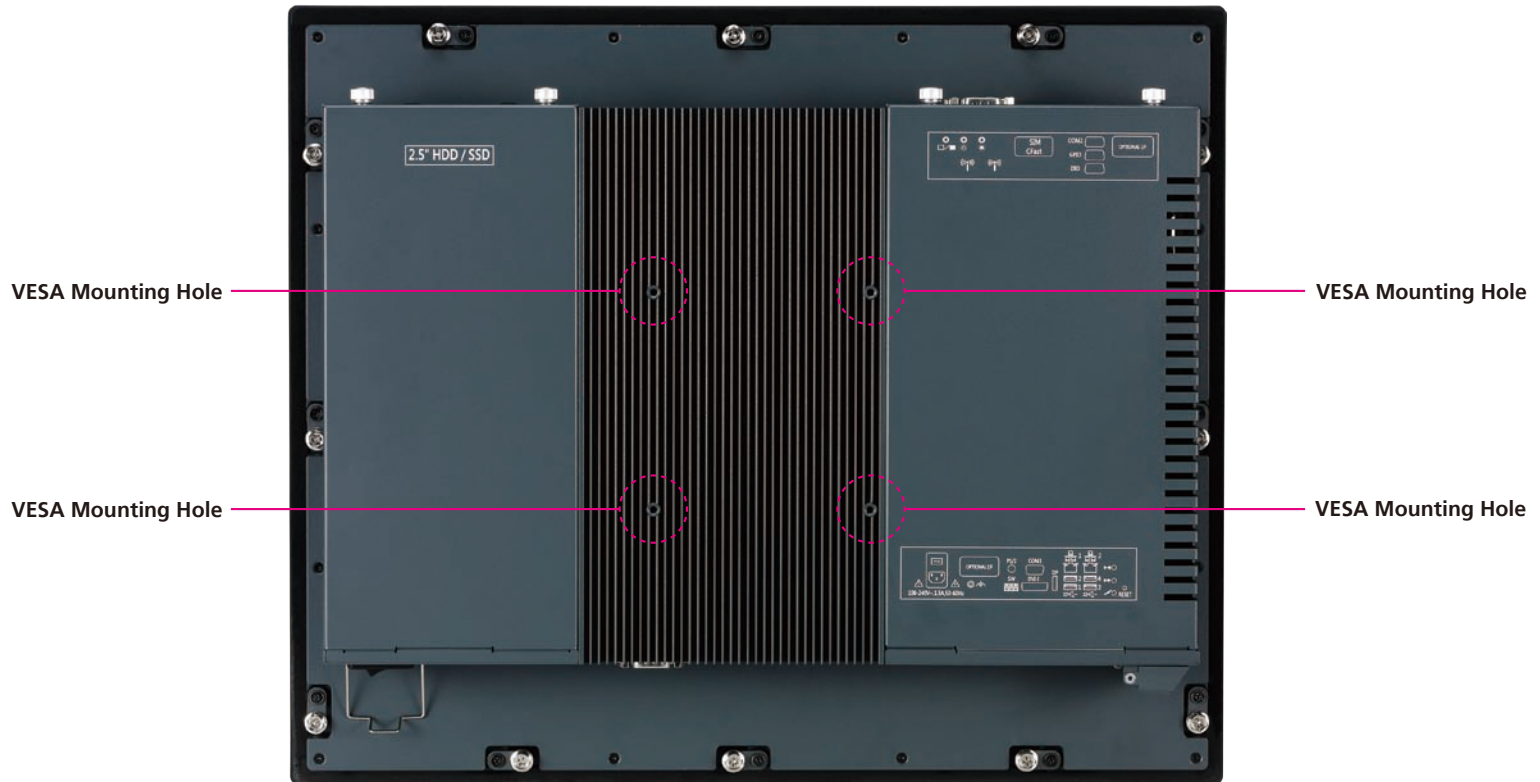

VESA Mounting Holes

These are mounting holes for VESA mount (100x100mm)

IPPC A1570T/P-DC, IPPC 1670P-DC, IPPC A1970T/P-DC, IPPC 2170P-DC Rear

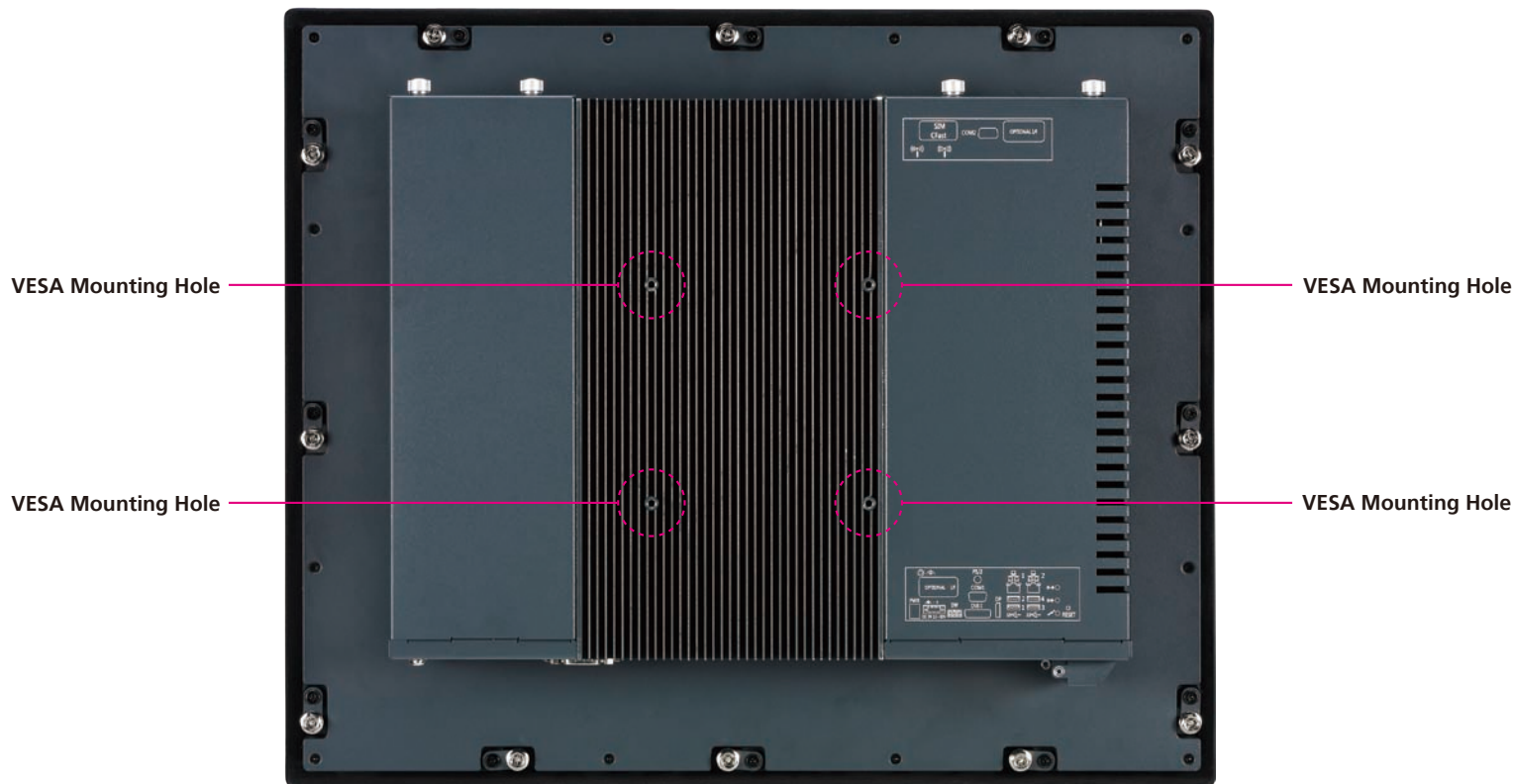

VESA Mounting Holes

These are mounting holes for VESA mount (100x100mm)

Mechanical Dimensions

IPPC A1570T/P-DC

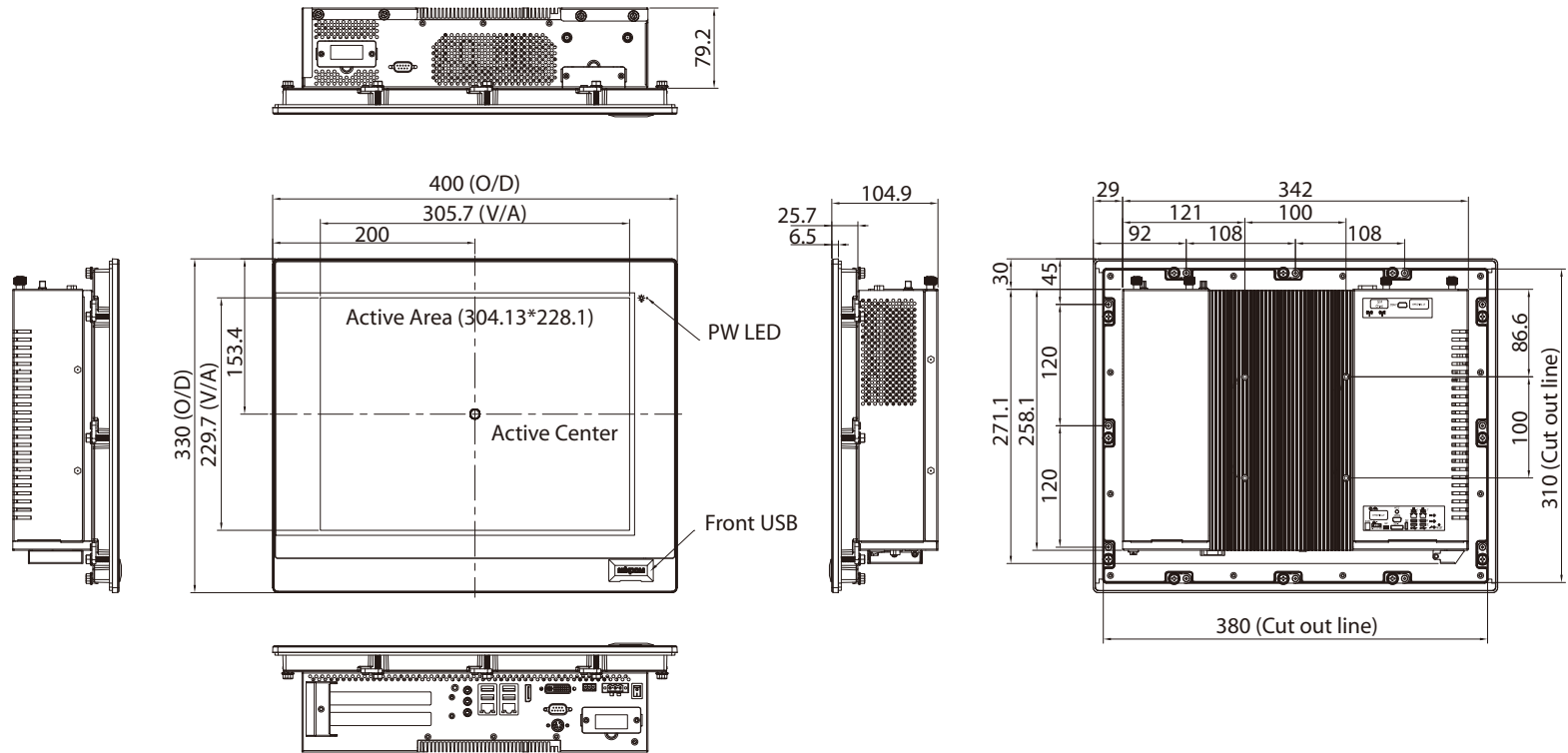

IPPC 1670P-DC

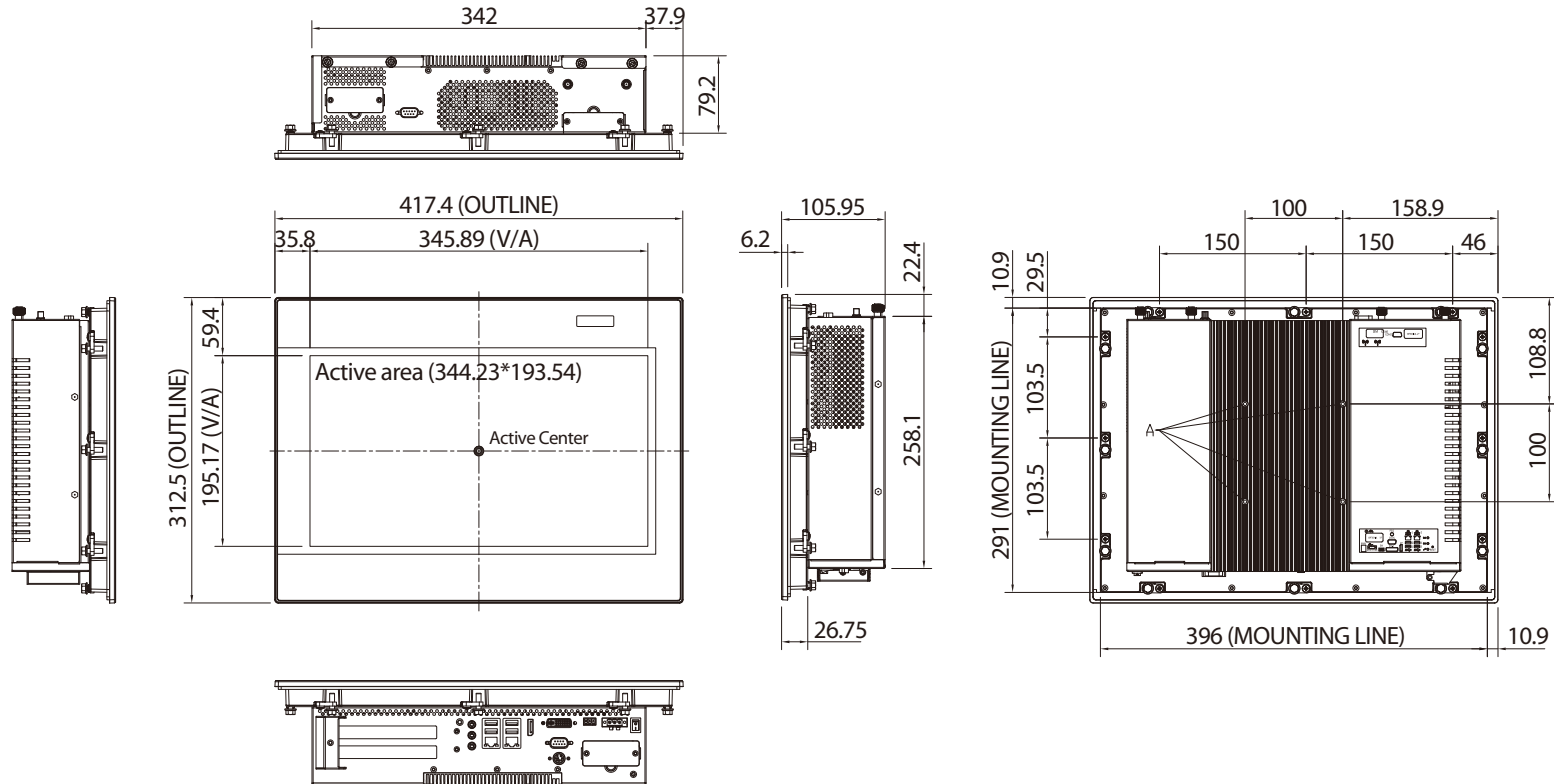

IPPC A1770T/P-AC

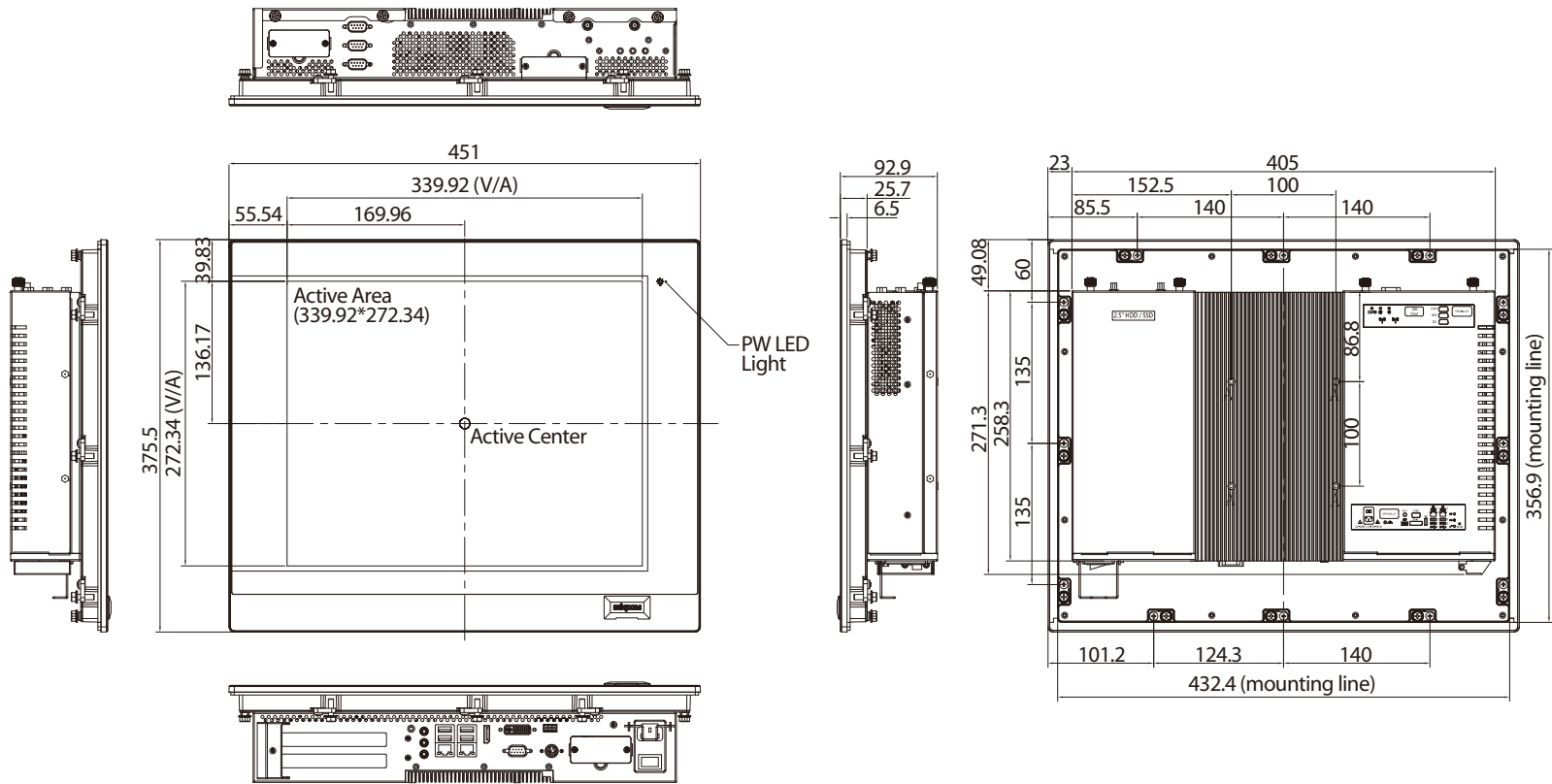

IPPC A1770TF-DC (Fan Model)

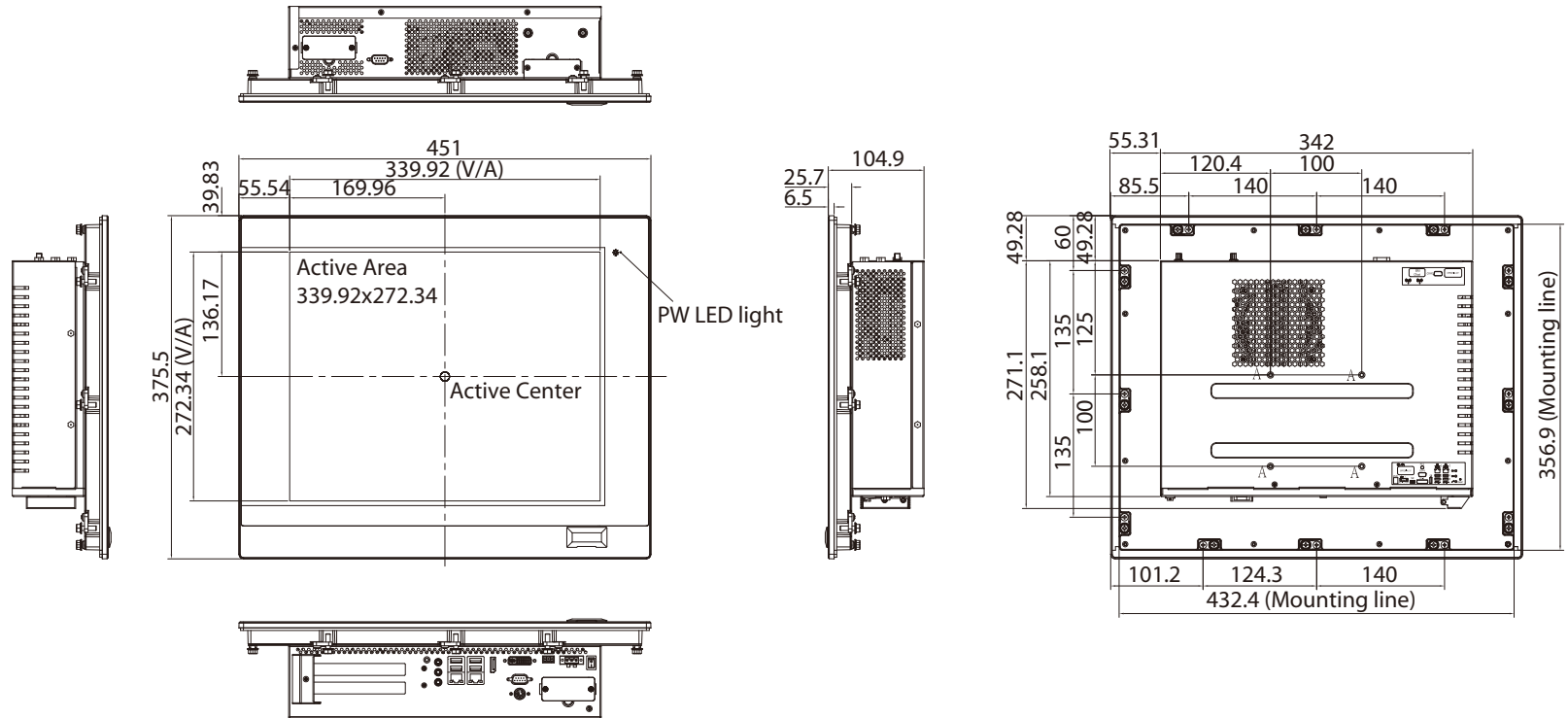

IPPC A1970T/P-DC

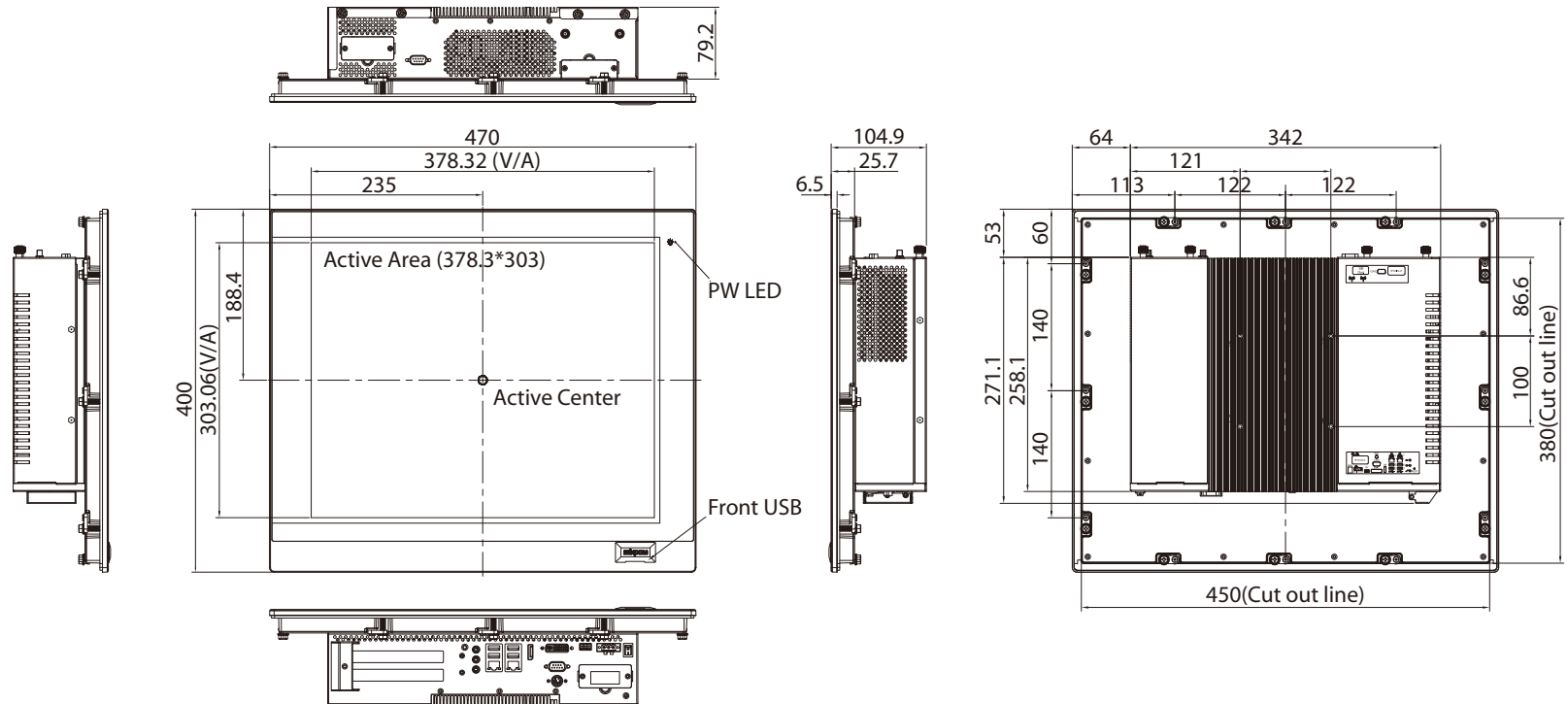

CHAPTER 2: JUMPERS AND CONNECTORS

This chapter describes how to set the jumpers and connectors on the motherboard. The information in this chapter applies to the IPPC A1770T and IPPC A1770P series.

Before You Begin

- Ensure you have a stable, clean working environment. Dust and dirt can get into components and cause a malfunction. Use containers to keep small components separated.
- Adequate lighting and proper tools can prevent you from accidentally damaging the internal components. Most of the procedures that follow require only a few simple tools, including the following:
 - A Philips screwdriver
 - A flat-tipped screwdriver
 - A set of jewelers screwdrivers
 - A grounding strap
 - An anti-static pad
- Using your fingers can disconnect most of the connections. It is recommended that you do not use needle-nosed pliers to disconnect connections as these can damage the soft metal or plastic parts of the connectors.
- Before working on internal components, make sure that the power is off. Ground yourself before touching any internal components, by touching a metal object. Static electricity can damage many of the electronic

components. Humid environments tend to have less static electricity than dry environments. A grounding strap is warranted whenever danger of static electricity exists.

Precautions

Computer components and electronic circuit boards can be damaged by discharges of static electricity. Working on computers that are still connected to a power supply can be extremely dangerous.

Follow the guidelines below to avoid damage to your computer or yourself:

- Always disconnect the unit from the power outlet whenever you are working inside the case.
- If possible, wear a grounded wrist strap when you are working inside the computer case. Alternatively, discharge any static electricity by touching the bare metal chassis of the unit case, or the bare metal body of any other grounded appliance.
- Hold electronic circuit boards by the edges only. Do not touch the components on the board unless it is necessary to do so. Don't flex or stress the circuit board.
- Leave all components inside the static-proof packaging that they shipped with until they are ready for installation. Use correct screws and do not over tighten screws.

Jumper Settings

A jumper is the simplest kind of electric switch. It consists of two metal pins and a cap. When setting the jumpers, ensure that the jumper caps are placed on the correct pins. When the jumper cap is placed on both pins, the jumper is short. If you remove the jumper cap, or place the jumper cap on just one pin, the jumper is open.

Refer to the illustrations below for examples of what the 2-pin and 3-pin jumpers look like when they are short (on) and open (off).

Two-Pin Jumpers: Open (Left) and Short (Right)

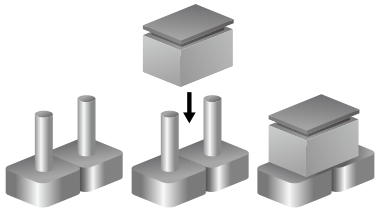

Three-Pin Jumpers: Pins 1 and 2 are Short

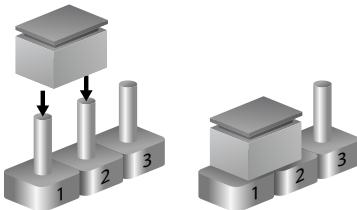

Bottom View

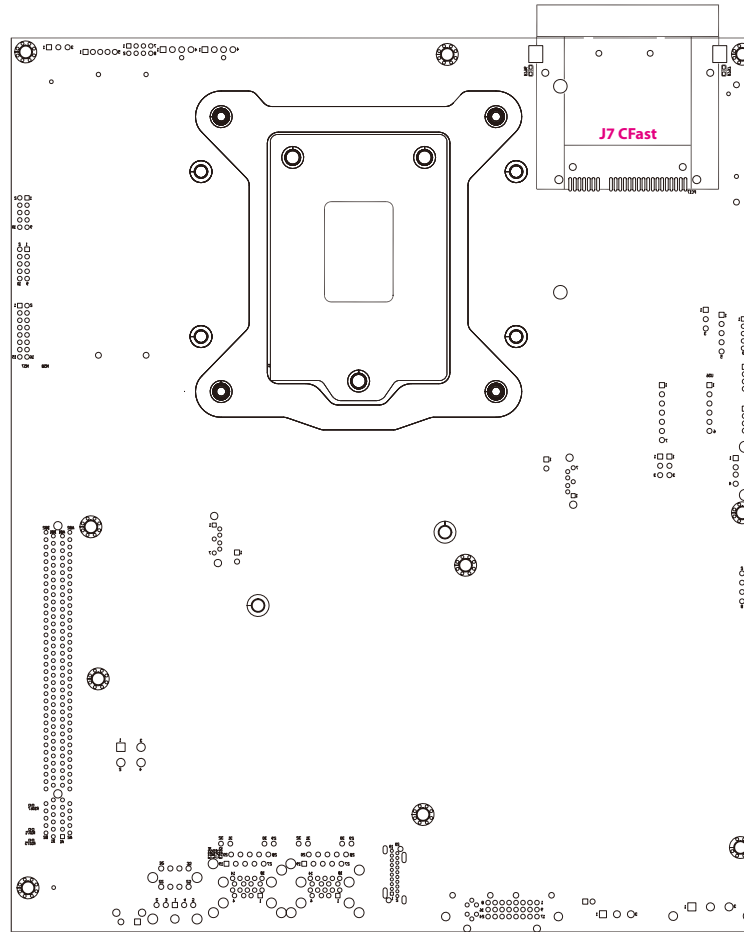

Jumpers and DIP Switch Settings

RTC Clear Select

Connector type: 1x3 3-pin header, 2.54mm pitch
Connector location: JP2



Pin	Settings
1-2 On	Normal
2-3 On	Clear BIOS

1-2 On: default

Pin	Definition
1	NC
2	RTC Power
3	GND

AT/ATX Selection

Connector type: 1x3 3-pin header, 2.54mm pitch
Connector location: JP9



Pin	Settings
1-2 On	AT Mode
2-3 On	ATX Mode

2-3 On: default

Pin	Definition
1	AUTO (AT MODE)
2	PWRBT In
3	Manual (ATX MODE)

Panel Resolution Select

Connector type: 4-pin On/Off Switch

Connector location: SW2

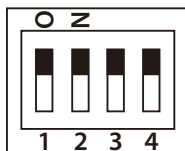

SW2-1	SW2-2	SW2-3	SW2-4	Resolution
OFF	OFF	ON	ON	1280 x 1024 (17")

Dimming Signal Level Select

Connector type: 1x3 3-pin header, 2.54mm pitch

Connector location: JP7



Pin	Settings
1-2 On	3.3V
2-3 On	5V

2-3 On: default 17" panel

Pin	Definition
1	VCC3
2	Power for Dimming
3	VCC5

LCD Panel VDD Power Select

Connector type: 1x3 3-pin header, 2.54mm pitch

Connector location: JP8



Pin	Settings
1-2 On	3.3V
2-3 On	5V

2-3 On: default 17" panel

Pin	Definition
1	VCC3
2	Power for VDD
3	VCC5

COM1 and COM2 Power Select

Connector type: 2x3 6-pin header, 2.0mm pitch

Connector location: JP12 (COM1) and JP5 (COM2)

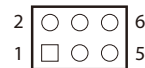

Pin	Settings
1-2 On	SP3_RI
3-4 On	+5V
5-6 On	+12V

1-2 On: default

Touch 4/5 Wire Select

Connector type: 1x3 3-pin header, 2.54mm pitch
Connector location: JP6



Pin	Settings
1-2 On	5 wire
2-3 On	4 wire

1-2 On: default

Connector Pin Definitions

External I/O Interface

Reset Button

Connector location: RESET1



Pin	Definition
1	GND
2	RESET

Audio Connectors

Connector type: 3.5mm audio jack

Connector location: AUDIO1

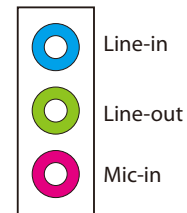

Pin	Definition	Pin	Definition
1	GND	2	MIC1_IN_L
3	MIC_JD	4	GND
5	MIC_IN_R		
22	LINE_OUT_L	23	LINE_OUT_JD
24	GND	25	LINE_OUT_R
32	LINE_IN_L	33	LINEIN_JD
34	GND	35	LINE_IN_R

LAN1 and Dual USB3.0 Ports

Connector type: RJ45 port with LEDs

Dual USB 3.0 ports, Type A

Connector location: LAN1A (USB) and LAN1B (LAN1)

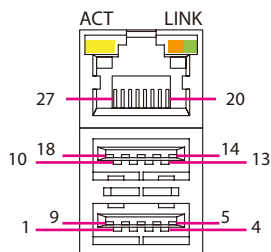

USB

Pin	Definition	Pin	Definition
1	+5V_1	2	USB1 D-(2.0)
3	USB1 D+(2.0)	4	GND
5	USB1 RX-(3.0)	6	USB1 RX+(3.0)
7	GND	8	USB1 TX-(3.0)
9	USB1 TX+(3.0)	10	+5V_2
11	USB2 D-(2.0)	12	USB1 D+(2.0)
13	GND	14	USB2 RX-(3.0)
15	USB2 RX+(3.0)	16	GND
17	USB2 TX-(3.0)	18	USB2 TX+(3.0)

LAN

Pin	Definition	Pin	Definition
19	VCT	20	LAN1_MDI0P
21	LAN1_MDI0N	22	LAN1_MDI1P
23	LAN1_MDI1N	24	LAN1_MDI2P
25	LAN1_MDI2N	26	LAN1_MDI3P
27	LAN1_MDI3N	28	GND
29	ACT_LED+	30	ACT_LED-
31	LINK100M#	32	LINK1G#

LAN2 and Dual USB3.0 Ports

Connector type: RJ45 port with LEDs

Dual USB 3.0 ports, Type A

Connector location: LAN2A (USB) and LAN2B (LAN2)

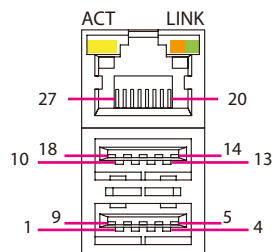

USB

Pin	Definition	Pin	Definition
1	+5V_1	2	USB3 D-(2.0)
3	USB3 D+(2.0)	4	GND
5	USB3 RX-(3.0)	6	USB3 RX+(3.0)
7	GND	8	USB3 TX-(3.0)
9	USB3 TX+(3.0)	10	+5V_2
11	USB4 D-(2.0)	12	USB3 D+(2.0)
13	GND	14	USB4 RX-(3.0)
15	USB4 RX+(3.0)	16	GND
17	USB4 TX-(3.0)	18	USB4 TX+(3.0)

LAN

Pin	Definition	Pin	Definition
19	VCT	20	LAN2_MDI0P
21	LAN2_MDI0N	22	LAN2_MDI1P
23	LAN2_MDI1N	24	LAN2_MDI2P
25	LAN2_MDI2N	26	LAN2_MDI3P
27	LAN2_MDI3N	28	GND
29	LAN2_ACT_LED+	30	LAN2_ACT_LED-
31	LAN2_LINK100M#	32	LAN2_LINK1G#

DisplayPort

Connector type: DisplayPort

Connector location: DP1

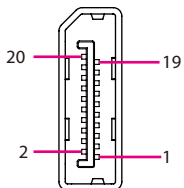

Pin	Definition	Pin	Definition
1	LANE0_P	2	GND
3	LANE0_N	4	LANE1_P
5	GND	6	LANE1_N
7	LANE2_P	8	GND
9	LANE2_N	10	LANE3_P
11	GND	12	LANE3_N
13	CONFIG1	14	CONFIG2
15	AUX_P	16	GND
17	AUX_N	18	Hot Plug Detect
19	PWR_RETURN(GND)	20	DP_PWR

DVI-I Connector

Connector type: 24-pin D-Sub, 2.0mm-M-180 (DVI)

Connector location: DVI1

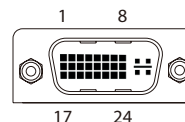

Pin	Definition	Pin	Definition
1	TX2-	2	TX2+
3	GND	4	NC
5	NC	6	DVI_DDC_CLK
7	DVI_DDC_DATA	8	VGA_VSYNC
9	TX1-	10	TX1+
11	GND	12	NC
13	NC	14	+5V
15	GND	16	Hot Plug Detect
17	TX0-	18	TX0+
19	GND	20	VGA_DDC_CLK
21	VGA_DDC_DATA	22	GND
23	TX_CLK+	24	TX_CLK-
C1	VGA_RED	C2	VGA_GREEN
C3	VGA_BLUE	C4	VGA_HSYNC
C5A	GND	C5B	GND

Remote Power Button Connector

Connector type: 1x3 3-pin terminal block

Connector location: PWBTN2



Pin	Definition
1	PWRBT
2	GND
3	SLP_S3#

12~30V DC Power Input (DC-Powered Models Only)

Connector type: 1x3 3-pin terminal block

Connector location: PW1

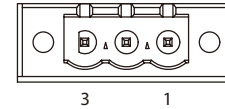

Pin	Definition
1	Power in +
2	Power in -
3	Mechanical GND

CFast Slot

Connector location: J7

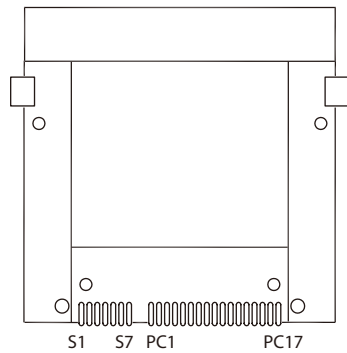

Pin	Definition	Pin	Definition
S1	GND	PC6	NC
S2	SATA_TXP2	PC7	GND
S3	SATA_TXN2	PC8	CFAST_LED1_C
S4	GND	PC9	CFAST_LED2_C
S5	SATA_RXN2	PC10	NC
S6	SATA_RXP2	PC11	NC
S7	GND	PC12	NC
PC1	CFAST_CDI	PC13	VCC3
PC2	GND	PC14	VCC3
PC3	NC	PC15	GND
PC4	NC	PC16	GND
PC5	NC	PC17	CFAST_CDO_C

SIM Card Slot

Connector location: CN1

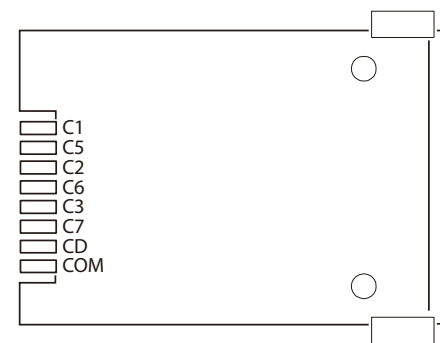

Pin	Definition	Pin	Definition
C1	UIM_PWR	C2	UIM_RST
C3	UIM_CLK	C5	GND
C6	UIM_VCCP	C7	UIM_DAT

Internal Connectors

DC Input

Connector type: 2x2 4-pin header

Connector location: PWR_CON1

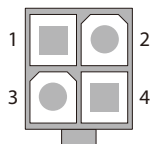

Pin	Definition	Pin	Definition
1	GND	2	GND
3	+12V	4	+12V

DC Output

Connector type: 2x2 4-pin header

Connector location: POE_CON1

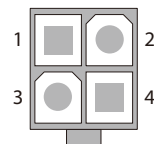

Pin	Definition	Pin	Definition
1	GND	2	GND
3	Power+(9V~30V)	4	Power+(9V~30V)

Power Button

Connector type: 1x2 2-pin header JST, 2.0mm pitch

Connector location: PWBTN1



Pin	Definition
1	PWRBT
2	GND

Backlight and Dimming Control Input Connector

Connector type: 2x5 10-pin header, 2.0mm pitch

Connector location: J3

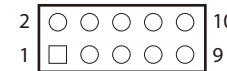

Pin	Definition	Pin	Definition
1	Light sensor power(3.3V)	2	3.3V
3	Light sensor input	4	PIR Input
5	Dimming increased input	6	Backlight On/OFF
7	Dimming decreased input	8	EC_SMBDATA
9	GND	10	EC_SMBCLK

LCD Backlight Connector

Connector type: 1x7 7-pin header JST, 2.5mm pitch

Connector location: J4

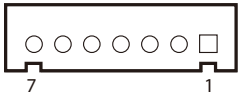

Pin	Definition	Pin	Definition
1	VCC5	2	12V
3	12V	4	BKCTRL
5	GND	6	GND
7	BKLEN		

LVDS Channel A Connector

Connector type: 2x10 20-pin header, 1.25mm pitch

Connector location: LVDS1

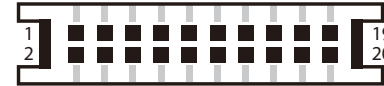

Pin	Definition	Pin	Definition
1	NC	2	NC
3	VDD	4	LVDS_DAT0P
5	LVDS_DAT3P	6	LVDS_DAT0N
7	LVDS_DAT3N	8	VDD
9	GND	10	LVDS_DAT1P
11	LVDS_CLK1P	12	LVDS_DAT1N
13	LVDS_CLK1N	14	GND
15	GND	16	+12V
17	LVDS_DAT2P	18	+12V
19	LVDS_DAT2N		

LVDS Channel B Connector

Connector type: 2x10 20-pin header, 1.25mm pitch

Connector location: LVDS2



Pin	Definition	Pin	Definition
1	NC	2	NC
3	VDD	4	LVDS_DAT4P
5	LVDS_DAT7P	6	LVDS_DAT4N
7	LVDS_DAT7N	8	VDD
9	GND	10	LVDS_DAT5P
11	LVDS_CLK2P	12	LVDS_DAT5N
13	LVDS_CLK2N	14	GND
15	GND	16	+12V
17	LVDS_DAT6P	18	+12V
19	LVDS_DAT6N		

Touch Sensor Connector

Connector type: 1x5 5-pin header JST, 2.5mm pitch

Connector location: J2

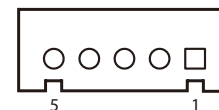

Pin	4-Wire	5-Wire
1	Bottom	UR (H)
2	Right	LR (X)
3	N/A	Sense (S)
4	Top	UL (Y)
5	Left	LL (L)

Internal USB Connector

Connector type: 1x6 6-pin header JST, 2.5mm pitch

Connector location: USB1

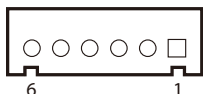

Pin	Definition	Pin	Definition
1	+5V	2	USB2_4N
3	USB2_4P	4	USB2_5N
5	USB_5P	6	GND

Front USB Connector

Connector type: 1x4 4-pin header JST, 2.0mm pitch

Connector location: FUSB1

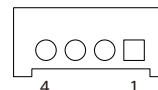

Pin	Definition	Pin	Definition
1	+5V	2	USB2_6N
3	USB2_6P	4	GND

Internal USB Connector

Connector type: 1x4 4-pin header JST, 2.0mm pitch

Connector location: USB2

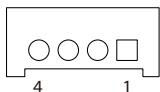

Pin	Definition	Pin	Definition
1	+5V	2	USB2_10N
3	USB2_10P	4	GND

USB Connector

Connector type: USB port

Connector location: USB3



Pin	Definition	Pin	Definition
1	+5V	2	USB2_11N
3	USB2_11P	4	GND

SATA0 Connector

Connector type: Standard Serial ATA 7P (1.27mm, SATA-M-180)

Connector location: CN5

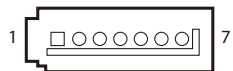

Pin	Definition	Pin	Definition
1	GND	2	TXP0
3	TXN0	4	GND
5	RXN0	6	RXP0
7	GND		

SATA1 Connector

Connector type: Standard Serial ATA 7P (1.27mm, SATA-M-180)

Connector location: CN6

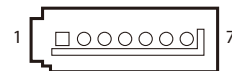

Pin	Definition	Pin	Definition
1	GND	2	TXP1
3	TXN1	4	GND
5	RXN1	6	RXP1
7	GND		

SATA/SATA DOM Power Connectors

Connector type: 1x2 2-pin header JST, 2.5mm pitch

Connector location: J5 and J6

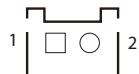

Pin	Definition
1	+5V
2	GND

Speaker-out Pin Header

Connector type: 1x4 4-pin header, 2.54mm pitch

Connector location: SPK1



Pin	Definition	Pin	Definition
1	OUT-L+	2	OUT-L-
3	OUT-R+	4	OUT-R-

COM1 Connector (Isolation with RS422/485 Feature)

Connector type: 2x5 10-pin header, 2.0mm pitch

Connector location: COM1

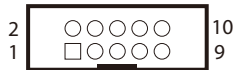

Pin	Definition	Pin	Definition
1	COM1_DCD	2	COM1_RXD
3	COM1_TXD	4	COM1_DTR
5	COM1_GND	6	COM1_DSR
7	COM1_RTS	8	COM1_CTS
9	COM1_RI	10	COM1_GND

COM2 Connector (Isolation with RS422/485 Feature)

Connector type: 2x5 10-pin header, 2.0mm pitch

Connector location: COM2



Pin	Definition	Pin	Definition
1	COM2_DCD	2	COM2_RXD
3	COM2_TXD	4	COM2_DTR
5	COM2_GND	6	COM2_DSR
7	COM2_RTS	8	COM2_CTS
9	COM2_RI	10	COM2_GND

DIO Connector

Connector type: 2x8 16-pin header, 2.0mm pitch

Connector location: CN4

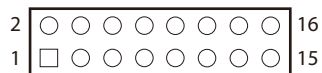

Pin	Definition	Pin	Definition
1	DI1	2	DO1
3	DI2	4	DO2
5	DI3	6	DO3
7	DI4	8	DO4
9	NC	10	NC
11	COM1	12	NC
13	GND	14	GND
15	GND	16	GND

GPIO Connector

Connector type: 2x5 10-pin header, 2.0mm pitch

Connector location: JP4

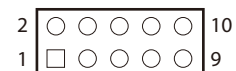

Pin	Definition	Pin	Definition
1	+5V	2	GND
3	GPI1 (GPI)	4	GPO1 (GPO)
5	GPI2 (GPI)	6	GPO2 (GPO)
7	GPI3 (GPI)	8	GPO3 (GPO)
9	GPI4 (GPI)	10	GPO4 (GPO)

RTC Battery Connector

Connector type: 1x2 2-pin header, 1.25mm pitch

Connector location: BAT1

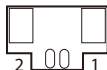

Pin	Definition
1	BATT-
2	BATT+

Active LED Connector

Connector type: 1x5 5-pin header JST, 2.5mm pitch

Connector location: J1

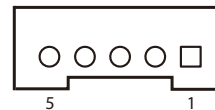

Pin	Definition	Pin	Definition
1	HDD_LED-	2	HDD_LED+
3	PWR_GND	4	5VSB
5	VCC5		

Software Programming IO Connector

Connector type: 2x4 8-pin header, 2.54mm pitch

Connector location: JP3

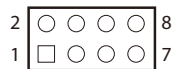

Pin	Definition	Pin	Definition
1	LED1+	2	LED1-
3	LED2+	4	LED2-
5	LED3+	6	LED3-
7	LED4+	8	LED4-

Keyboard/Mouse Connector

Connector type: 2x4 8-pin header, 2.54mm pitch

Connector location: JP10

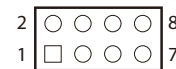

Pin	Definition	Pin	Definition
1	VCC5	2	VCC5
3	KB_DATA	4	MS_DATA
5	KB_CLK	6	MS_CLK
7	GND	8	GND

CPU Fan Connector

Connector type: 1x4 4-pin Wafer, 2.54mm pitch

Connector location: CPUFAN1



Pin	Definition	Pin	Definition
1	GND	2	+12V
3	FAN Speed Detect	4	FAN Speed Control

System Fan Connector

Connector type: 1x4 4-pin Wafer, 2.54mm pitch

Connector location: SYSFAN1



Pin	Definition	Pin	Definition
1	GND	2	+12V
3	FAN Speed Detect	4	FAN Speed Control

Printer Port Connector

Connector type: 2x13 26-pin header, 2.0mm pitch

Connector location: LPT1

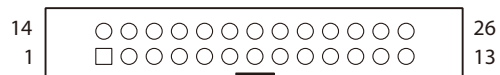

Pin	Definition	Pin	Definition
1	STB#	2	D0
3	D1	4	D2
5	D3	6	D4
7	D5	8	D6
9	D7	10	ACK#
11	BUSY	12	PE
13	SCLT	14	AFD#
15	ERR#	16	INIT#
17	SLIN#	18	GND
19	GND	20	GND
21	GND	22	GND
23	GND	24	GND
25	GND		

Mini-PCIe Slot (Wi-Fi/3G)

Connector location: CN2

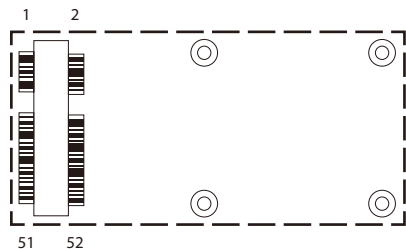

Pin	Definition	Pin	Definition
1	PCIEWAKE	2	3.3V
3	NC	4	GND
5	NC	6	1.5V
7	CLKREQ	8	UIM_PWR
9	GND	10	UIM_DAT
11	PCIECLKN	12	UIM_CLK
13	PCIECLKP	14	UIM_RST
15	GND	16	UIM_VCCP
17	NC	18	GND
19	NC	20	DISABLE
21	GND	22	PLTRSTBF
23	PCIERX4N	24	3.3V
25	PCIERX24P	26	GND

Pin	Definition	Pin	Definition
27	GND	28	1.5V
29	GND	30	SMBCLK
31	PCIETX4N	32	SMBDATA
33	PCIETX4P	34	GND
35	GND	36	USB2N
37	GND	38	USB2P
39	3.3V	40	GND
41	3.3V	42	NC
43	GND	44	NC
45	CL_CLK	46	NC
47	CL_DATA	48	1.5V
49	CL_RST#	50	GND
51	NC	52	3.3V

Mini-PCIe Slot (PCIe/mSATA)

Connector location: CN3

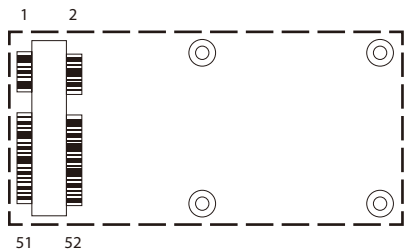

Pin	Definition	Pin	Definition
1	WAKE0#	2	+V3.3_MINI
3	NC	4	GND
5	NC	6	+V1.5S_MINI
7	NC	8	NC
9	GND	10	NC
11	GPP_CLK1_N	12	NC
13	GPP_CLK1_P	14	NC
15	GND	16	NC
17	NC	18	GND
19	NC	20	MINICARD1_DIS#
21	GND	22	PCIE_RST#
23	PCIE_RX2N/mSATA_RxP	24	+V3.3A_MINI
25	PCIE_RX2P/mSATA_RxN	26	GND

Pin	Definition	Pin	Definition
27	GND	28	+V1.5S_MINI
29	GND	30	SMB_CLK
31	PCIE_TX3N/mSATA_TxN	32	SMB_DAT
33	PCIE_TX3P/mSATA_TxP	34	GND
35	GND	36	USB_1N
37	GND	38	USB_1P
39	+V3.3A_MINI	40	GND
41	+V3.3A_MINI	42	NC
43	GND	44	NC
45	NC	46	NC
47	NC	48	+V1.5S_MINI
49	NC	50	GND
51	PCIE/mSATA detect	52	+V3.3A_MINI

PCIe x16 Slot

Connector type: PCIe x16 Slot

Connector location: PCIE1



Pin	Definition	Pin	Definition
A1	PCIE_PRSENT1	B1	12V
A2	12V	B2	12V
A3	12V	B3	12V
A4	GND	B4	GND
A5	TCK	B5	SMB_CLK
A6	TDI	B6	SMB_DATA
A7	NC	B7	GND
A8	TMS	B8	3.3V
A9	3.3V	B9	GND
A10	3.3V	B10	3.3V standby
A11	RESET#	B11	Wake#
A12	GND	B12	GPU_POK
A13	CLK+	B13	12V
A14	CLK-	B14	PET0+
A15	GND	B15	PET0-
A16	PER0+	B16	GND
A17	PER0-	B17	PRSENT#
A18	GND	B18	GND

Pin	Definition	Pin	Definition
A19	GPU_PWR_EN#	B19	PET1+
A20	GND	B20	PET1-
A21	PER1+	B21	GND
A22	PER1-	B22	GND
A23	GND	B23	PET2+
A24	GND	B24	PET2-
A25	PER2+	B25	GND
A26	PER2-	B26	GND
A27	GND	B27	PET3+
A28	GND	B28	PET3-
A29	PER3+	B29	GND
A30	PER3-	B30	GPU_PRSENT#
A31	GND	B31	NC
A32	NC	B32	GND
A33	NC	B33	PET4+
A34	GND	B34	PET4-
A35	PER4+	B35	GND
A36	PER4-	B36	GND

Pin	Definition	Pin	Definition
A37	GND	B37	PET5+
A38	GND	B38	PET5-
A39	PER5+	B39	GND
A40	PER5-	B40	GND
A41	GND	B41	PET6+
A42	GND	B42	PET6-
A43	PER6+	B43	GND
A44	PER6-	B44	GND
A45	GND	B45	PET7+
A46	GND	B46	PET7-
A47	PER7+	B47	GND
A48	PER7-	B48	NC
A49	GND	B49	GND
A50	NC	B50	PET8+
A51	GND	B51	PET8-
A52	PER8+	B52	GND
A53	PER8-	B53	GND
A54	GND	B54	PET9+
A55	GND	B55	PET9-
A56	PER9+	B56	GND
A57	PER9-	B57	GND
A58	GND	B58	PET10+
A59	GND	B59	PET10-

Pin	Definition	Pin	Definition
A60	PER10+	B60	GND
A61	PER10-	B61	GND
A62	GND	B62	PET11+
A63	GND	B63	PET11-
A64	PER11+	B64	GND
A65	PER11-	B65	GND
A66	GND	B66	PET12+
A67	GND	B67	PET12-
A68	PER12+	B68	GND
A69	PER12-	B69	GND
A70	GND	B70	PET13+
A71	GND	B71	PET13-
A72	PER13+	B72	GND
A73	PER13-	B73	GND
A74	GND	B74	PET14+
A75	GND	B75	PET14-
A76	PER14+	B76	GND
A77	PER14-	B77	GND
A78	GND	B78	PET15+
A79	GND	B79	PET15-
A80	PER15+	B80	GND
A81	PER15-	B81	NC
A82	GND	B82	GPU_SELECT#



Note: This slot supports a maximum power consumption of 25W.

CHAPTER 3: SYSTEM SETUP

Installing a Riser Card



Prior to removing the chassis cover, make sure the unit's power is off and disconnected from the power sources to prevent electric shock or system damage.

1. Remove the 4 screws on the rear top panel. **(For IPPC A1770T/P Series)**



2. Remove the screws on the back and around the sides of the rear panel. **(For IPPC A1770TF-DC)**

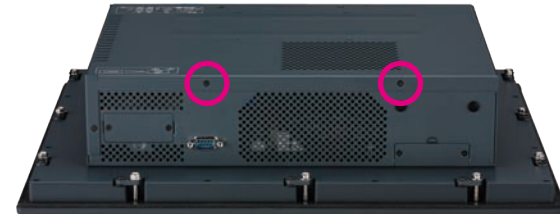
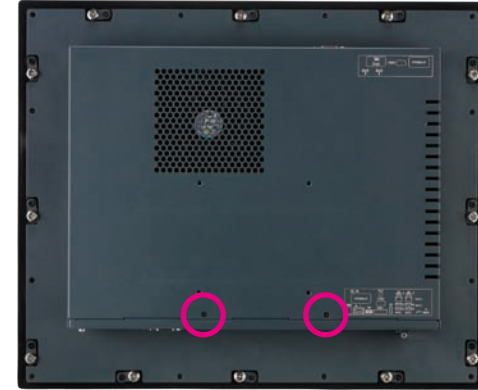

3. On the rear bottom panel, remove the screw on the PCI/PCIe expansion cover.

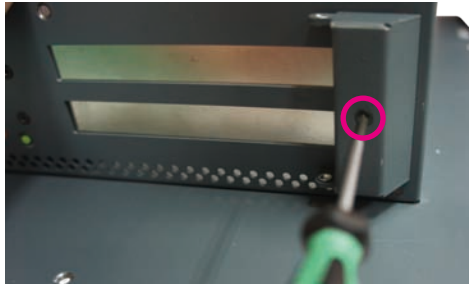
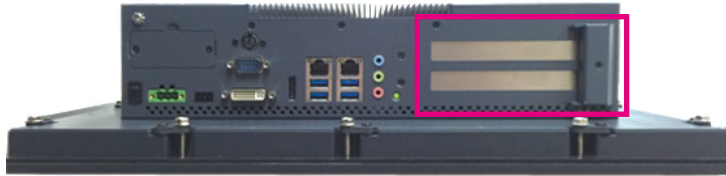

4. Open the PCI/PCIe bracket cover.



5. Remove the screw on the PCI/PCIe slot.

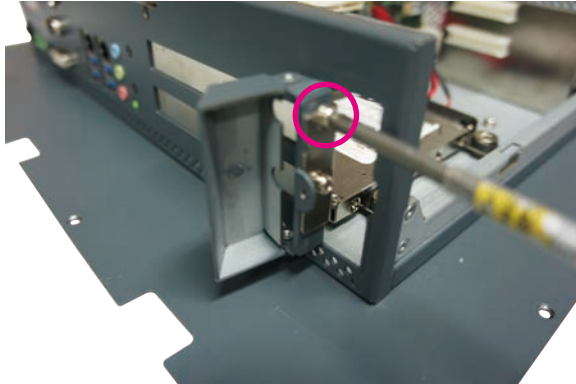

6. Remove the PCI/PCIe slot cover.



7. Remove the screws on the riser card bracket, which will be used to secure the rear end of the riser card.

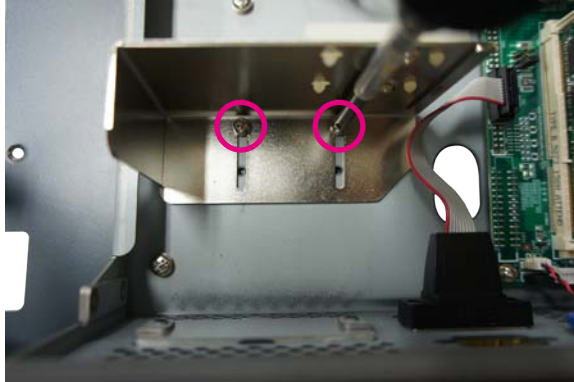

8. Install the riser card.

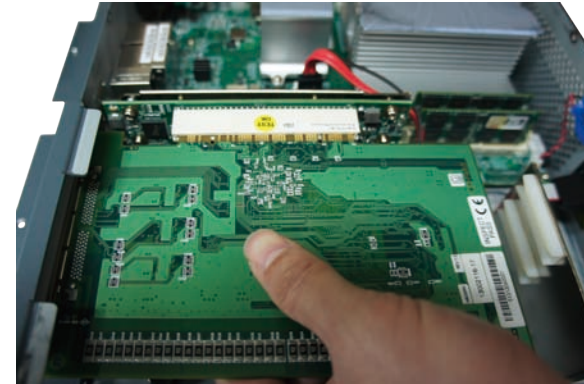

9. Push the riser card bracket towards the riser card until it secures the card in place.



10. Secure the riser card bracket with screws.

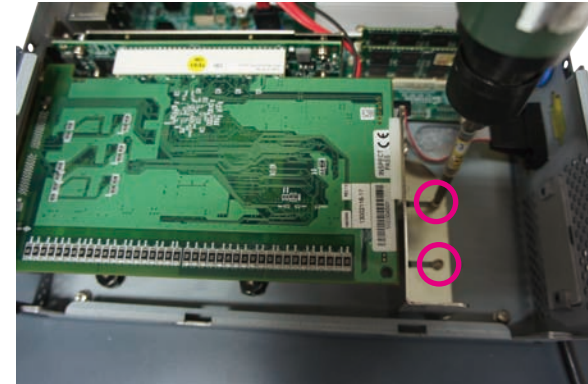

Alternative Method for Fixing the Riser Card

1. Remove the screws on the riser card bracket.

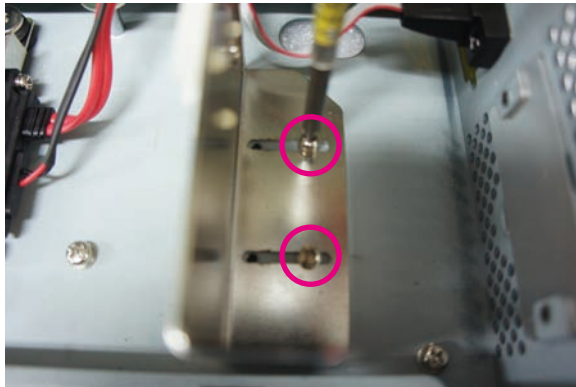

2. Take out the riser card bracket.



3. Put the plastic screw through the screw hole.



4. Push the riser card bracket towards the riser card until the plastic screw secures the card in place.

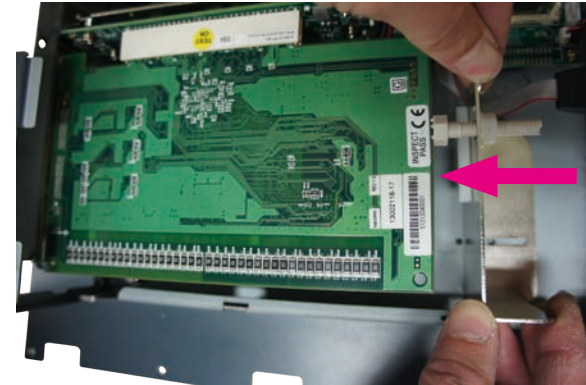

5. Secure the riser card bracket with screws.

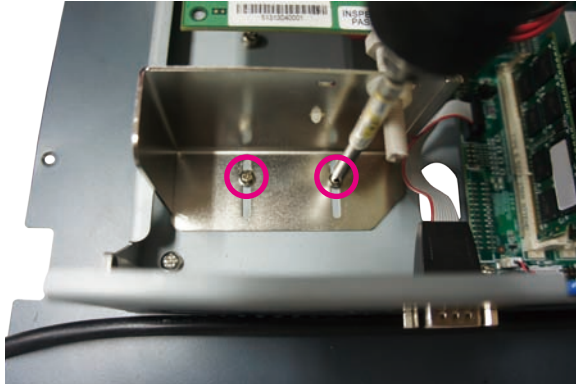

6. Cut off the remaining plastic screw end.

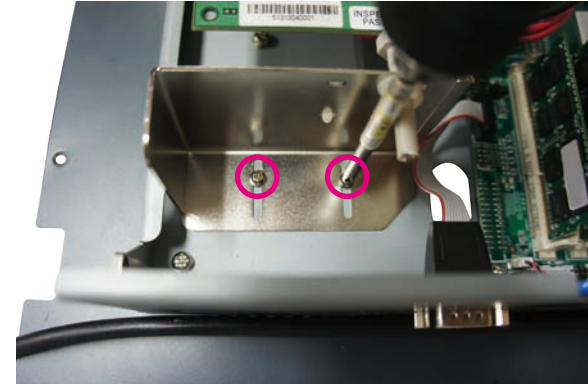

7. Fasten the screw back to the PCI/PCIe expansion slot cover to secure the riser card.



Installing a CFast Card and Mini-PCIe 3G/4G SIM Card

1. The CFast slot is located on the rear top side of the chassis. Remove the screws on the cover and take it off the chassis.

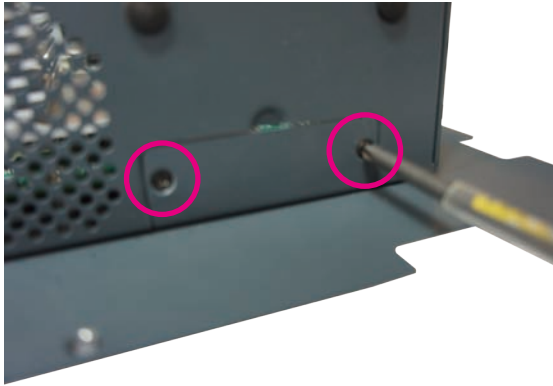

2. Insert the CFast card until it is completely seated in the socket.



3. Insert the SIM card until it is completely seated in the socket.

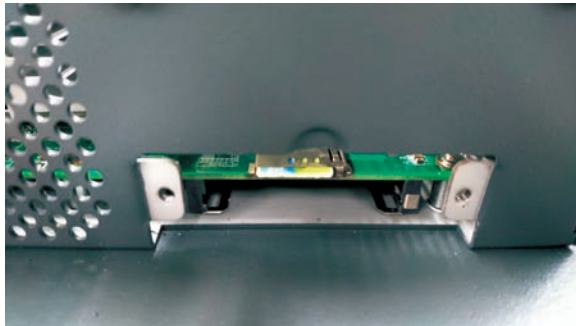
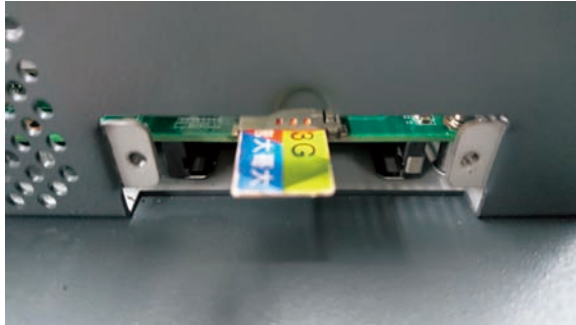

4. Screw the cover back in place.

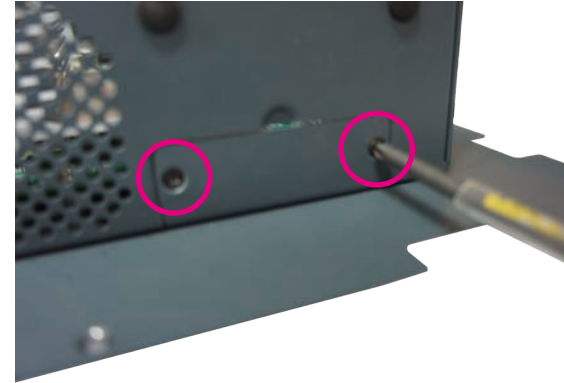

Installing a Mini-PCle Module

1. Insert the mini-PCle module into the mini-PCle slot at a 45-degree angle until the gold-plated connector on the edge of the module completely disappears inside the slot.

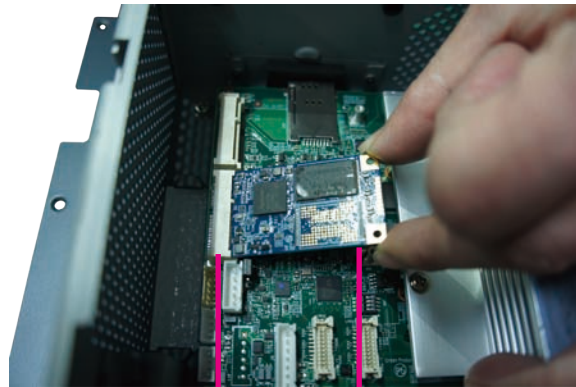

Mini-PCle Slot

Mini-PCle Module

2. Secure the module with mounting screw.



Installing a CPU

Removing the CPU Fan (For IPPC A1770TF-DC)

Before installing a CPU for IPPC A1770TF-DC, please follow the steps below to remove the CPU fan first.

1. Locate the CPU fan and remove the 4 screws on each corner of the fan.

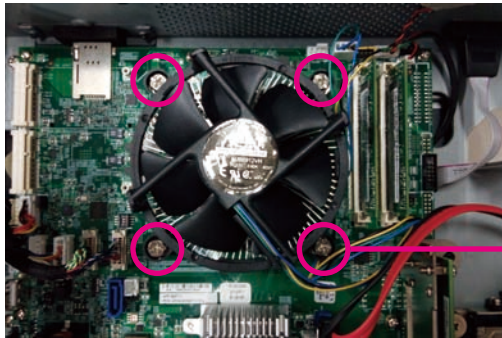

Mounting
Screws

2. With the screws loosened, remove the CPU fan by lifting it up.



3. Locate the CPU socket beneath and unlock the socket by pushing the load lever down, moving it sideways until it is released from the retention tab; then lift the load lever up.

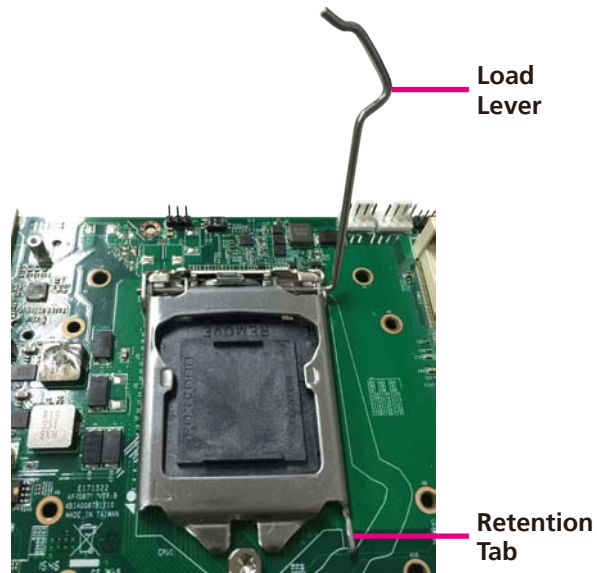

4. Lift the load plate up.

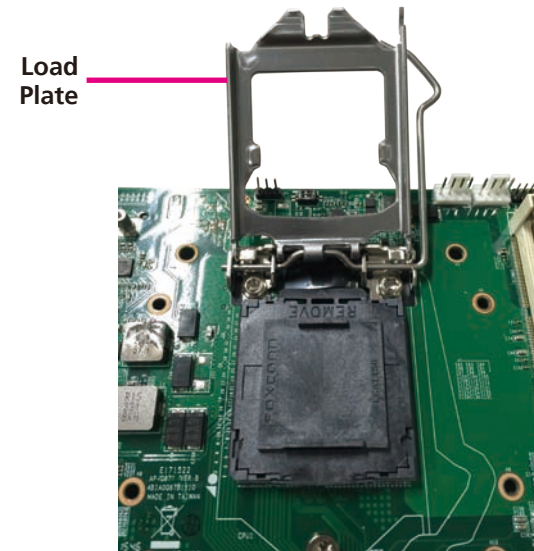

5. Remove the protective cap from the CPU socket. The cap is used to protect the CPU socket against dust and harmful particles. Remove the protective cap only when you are about to install the CPU.

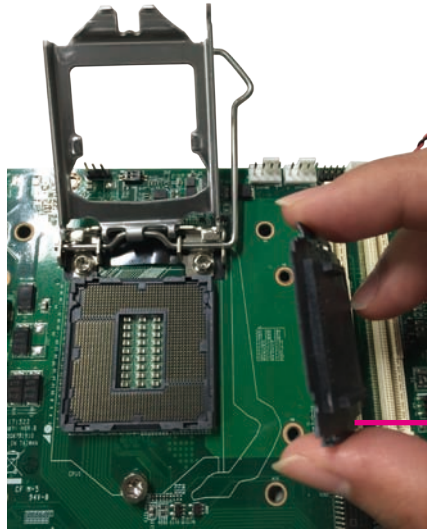

Protective
Cap

6. Insert the CPU into the socket. The triangular edge on the CPU must align with the corner of the CPU socket shown on the photo.

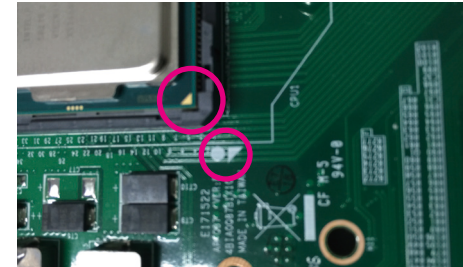

- Handle the CPU by its edges and avoid touching the pins.
- The CPU will fit in only one orientation and can easily be inserted without exerting any force.

7. Close the load plate and then hook the load lever under the retention tab.

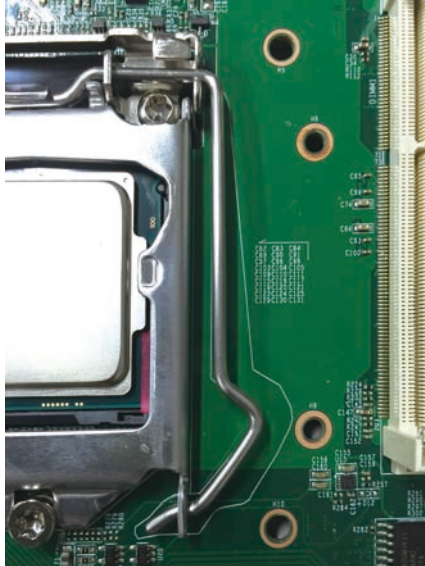

8. Install the heat sink on top of the CPU.

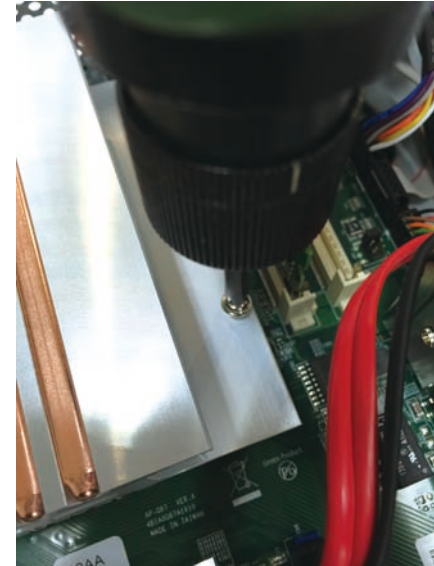

Do not force the CPU into the socket. Forcing the CPU into the socket may bend the pins and damage the CPU.

Installing a SO-DIMM Memory Module

1. Locate the SO-DIMM sockets and insert the module into the socket at an approximately 30-degree angle. Apply firm even pressure to each end of the module until it slips into the socket. The gold-plated connector on the edge of the module will almost completely disappear inside the socket.
2. Push the module down until the clips on both sides of the socket lock into position. You will hear a distinctive “click” sound, indicating the module is correctly locked into position.

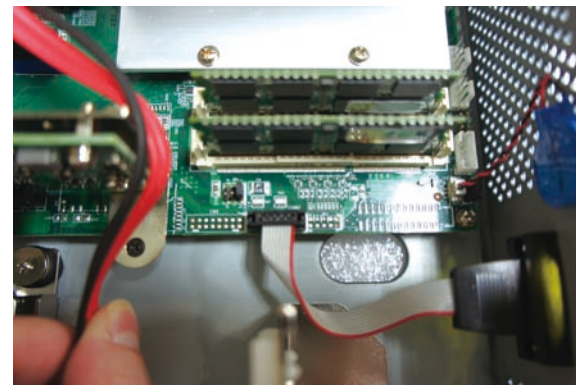
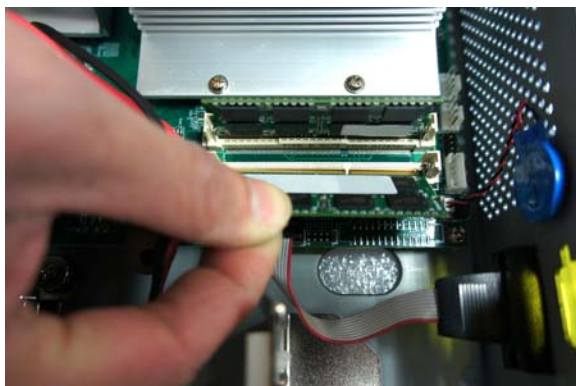

Installing a Primary 2.5" HDD/SDD (-AC Model Only)

1. With the chassis cover removed, locate the primary hard drive bracket and remove the mounting screws on the bracket.
2. Place the hard drive into the bracket until the connector on the hard drive is completely seated into the SATA connector on the bracket. Secure the bracket back to its original location.

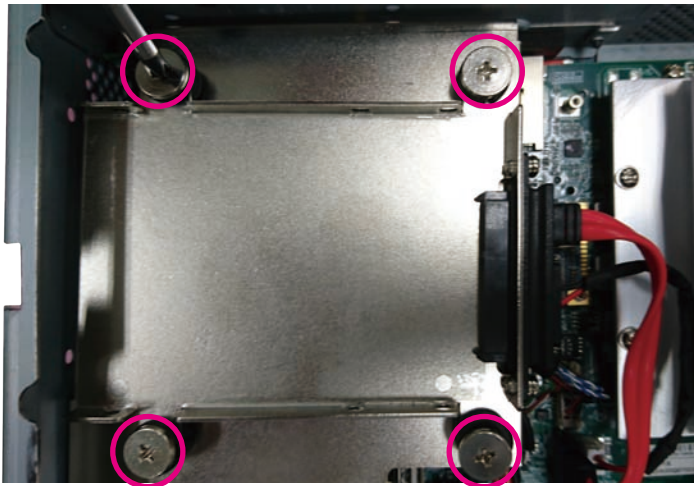

SATA Connector

Installing a Secondary 2.5" HDD/SDD

1. With the chassis cover removed, locate the secondary hard drive bracket and remove the mounting screws on the bracket.
2. Place the hard drive into the bracket until the connector on the hard drive is completely seated into the SATA connector on the bracket.

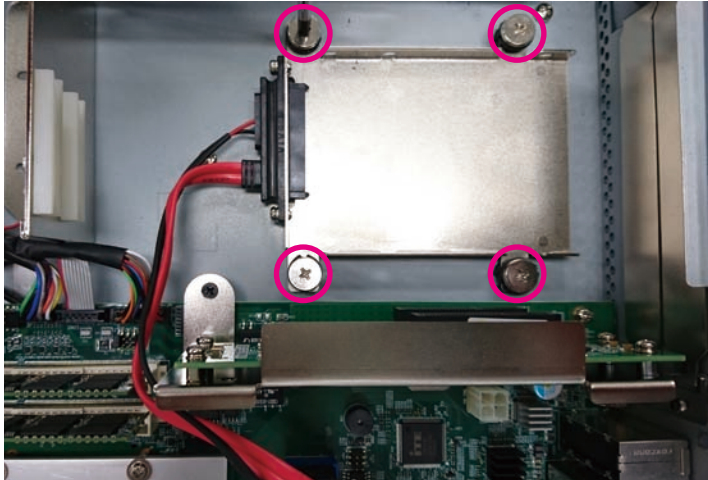

SATA Connector

3. Secure the SATA connector with screws.

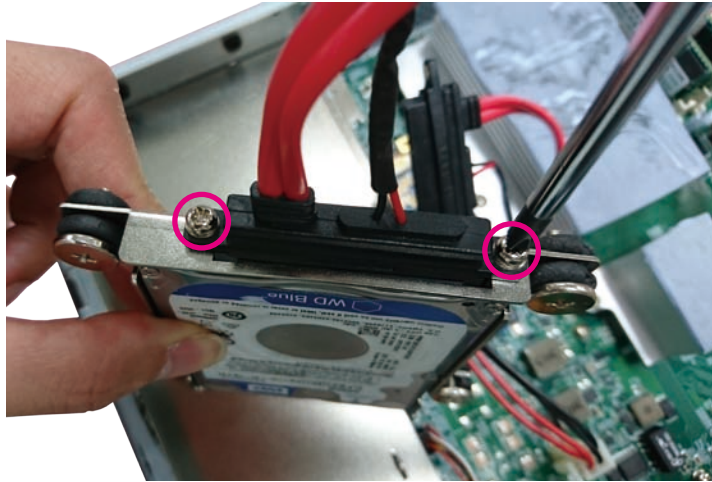

4. Secure the hard drive by fastening screws on the sides of the bracket.

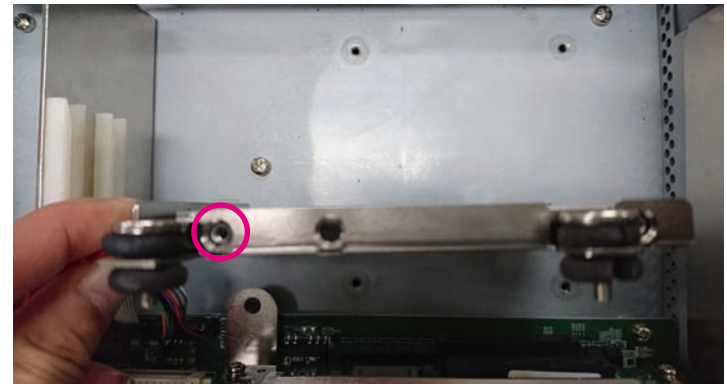
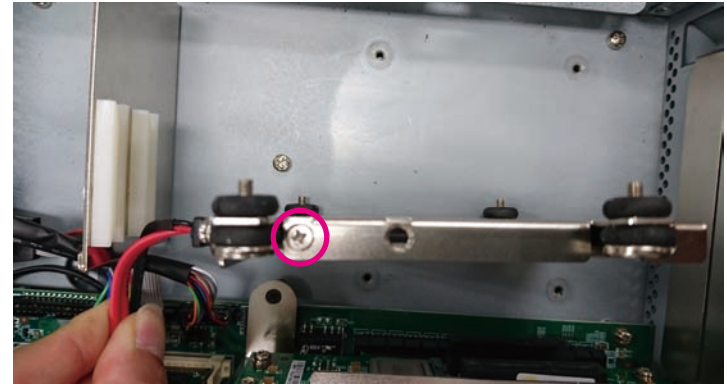

5. Secure the bracket back to its original location.



6. Install the cable tie mount to the bottom plate near the SATA power and data cables, then secure the cables to the cable tie mount.

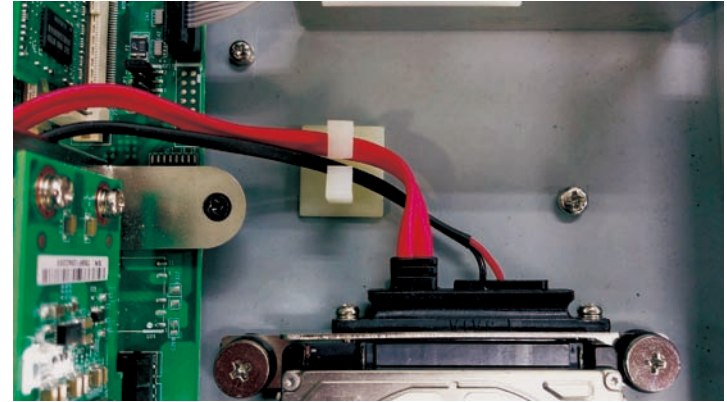

Panel Mounting

1. Select a place on the panel where you will mount the panel PC.
2. Cut out a shape on the panel that corresponds to the panel PC's rear dimensions.

The thickness of the panel (e.g. steel board, plank, acrylic board, wall, etc.) where you will mount the Panel PC must not exceed 12mm. If the distance between the front bezel and panel mount hole is too wide, it will not fit the panel mount kit.

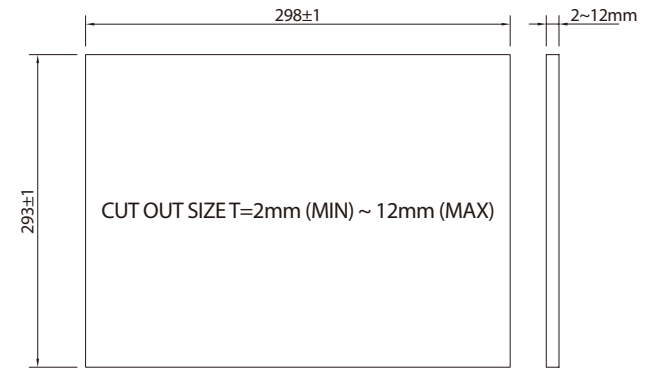

IPPC 1670P-DC

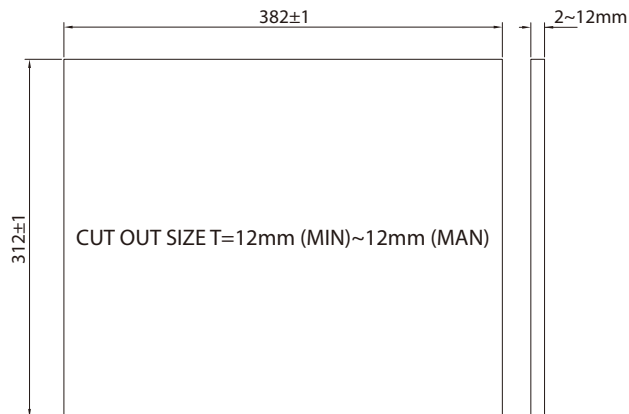

IPPC A1570 Series

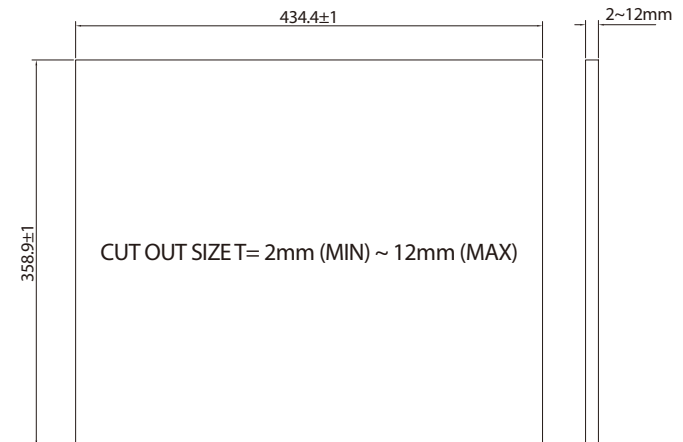

IPPC A1770 Series

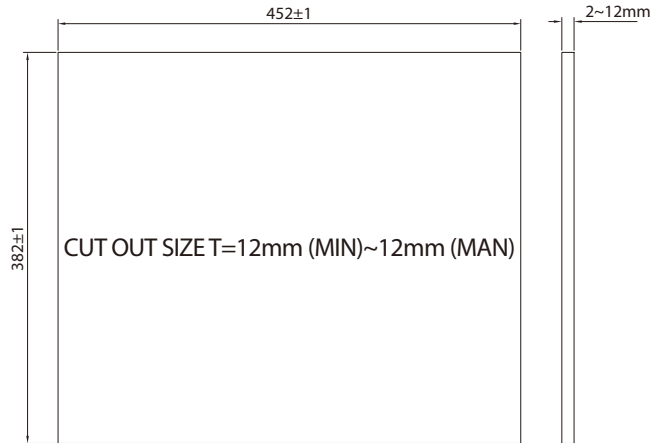

IPPC A1970 Series

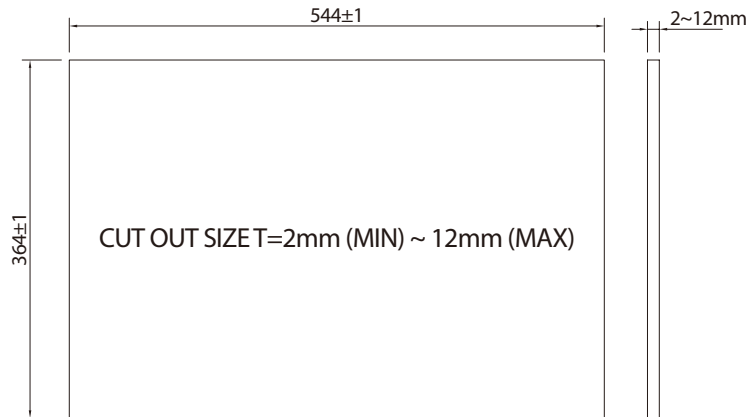

IPPC 2170P

- Slide the panel PC through the hole until it is properly fitted against the panel.
- Position the mounting clamps along the rear edges of the Panel PC. The first and second clamps must be positioned and secured diagonally prior to mounting the rest of the clamps. Tighten the clamp's screw until it touches the panel.



The torque of the screw must be greater than 12kgf-cm.

CHAPTER 4: BIOS SETUP

This chapter describes how to use the BIOS setup program for the IPPC A1770T and IPPC A1770P. The BIOS screens provided in this chapter are for reference only and may change if the BIOS is updated in the future.

To check for the latest updates and revisions, visit the NEXCOM website at www.nexcom.com.tw.

About BIOS Setup

The BIOS (Basic Input and Output System) Setup program is a menu driven utility that enables you to make changes to the system configuration and tailor your system to suit your individual work needs. It is a ROM-based configuration utility that displays the system's configuration status and provides you with a tool to set system parameters.

These parameters are stored in non-volatile battery-backed-up CMOS RAM that saves this information even when the power is turned off. When the system is turned back on, the system is configured with the values found in CMOS.

With easy-to-use pull down menus, you can configure items such as:

- Hard drives, diskette drives, and peripherals
- Video display type and display options
- Password protection from unauthorized use
- Power management features

The settings made in the setup program affect how the computer performs. It is important, therefore, first to try to understand all the setup options, and second, to make settings appropriate for the way you use the computer.

When to Configure the BIOS

- This program should be executed under the following conditions:
- When changing the system configuration
- When a configuration error is detected by the system and you are prompted to make changes to the setup program
- When resetting the system clock
- When redefining the communication ports to prevent any conflicts
- When making changes to the Power Management configuration
- When changing the password or making other changes to the security setup

Normally, CMOS setup is needed when the system hardware is not consistent with the information contained in the CMOS RAM, whenever the CMOS RAM has lost power, or the system features need to be changed.

Default Configuration

Most of the configuration settings are either predefined according to the Load Optimal Defaults settings which are stored in the BIOS or are automatically detected and configured without requiring any actions. There are a few settings that you may need to change depending on your system configuration.

Entering Setup











When the system is powered on, the BIOS will enter the Power-On Self Test (POST) routines. These routines perform various diagnostic checks; if an error is encountered, the error will be reported in one of two different ways:

- If the error occurs before the display device is initialized, a series of beeps will be transmitted.
- If the error occurs after the display device is initialized, the screen will display the error message.

Powering on the computer and immediately pressing allows you to enter Setup.

Press the  key to enter Setup:

Legends

Key	Function
	Moves the highlight left or right to select a menu.
	Moves the highlight up or down between sub-menus or fields.
	Exits the BIOS Setup Utility.
	Scrolls forward through the values or options of the highlighted field.
	Scrolls backward through the values or options of the highlighted field.
	Selects a field.
	Displays General Help.
	Load previous values.
	Load optimized default values.
	Saves and exits the Setup program.
	Press <Enter> to enter the highlighted sub-menu

Scroll Bar

When a scroll bar appears to the right of the setup screen, it indicates that there are more available fields not shown on the screen. Use the up and down arrow keys to scroll through all the available fields.

Submenu

When “▶” appears on the left of a particular field, it indicates that a submenu which contains additional options are available for that field. To display the submenu, move the highlight to that field and press  .

BIOS Setup Utility

Once you enter the AMI BIOS Setup Utility, the Main Menu will appear on the screen. The main menu allows you to select from several setup functions and one exit. Use arrow keys to select among the items and press  to accept or enter the submenu.

Main

The Main menu is the first screen that you will see when you enter the BIOS Setup Utility.

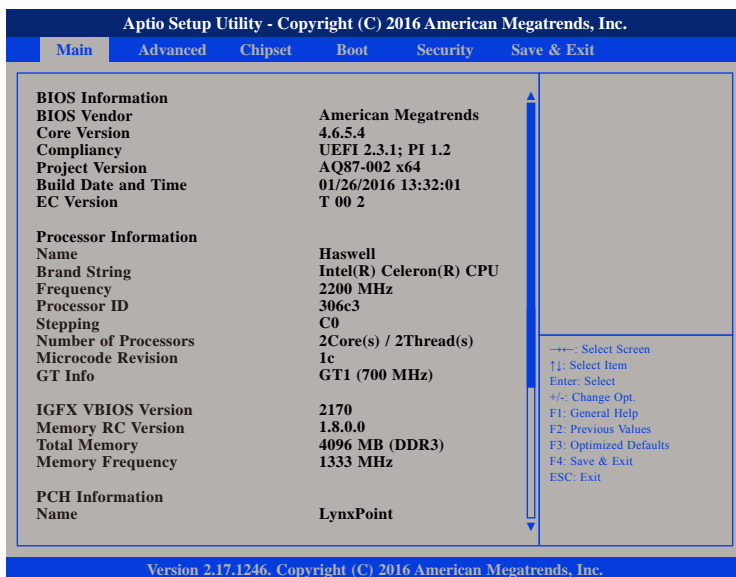

Aptio Setup Utility - Copyright (C) 2016 American Megatrends, Inc.					
Main	Advanced	Chipset	Boot	Security	Save & Exit
BIOS Information					
BIOS Vendor	American Megatrends				
Core Version	4.6.5.4				
Compliance	UEFI 2.3.1; PI 1.2				
Project Version	AQ87-002 x64				
Build Date and Time	01/26/2016 13:32:01				
EC Version	T 00 2				
Processor Information					
Name	Haswell				
Brand String	Intel(R) Celeron(R) CPU				
Frequency	2200 MHz				
Processor ID	306c3				
Stepping	C0				
Number of Processors	2Core(s) / 2Thread(s)				
Microcode Revision	1c				
GT Info	GT1 (700 MHz)				
IGFB VBIOS Version					
IGFB VBIOS Version	2170				
Memory RC Version	1.8.0.0				
Total Memory	4096 MB (DDR3)				
Memory Frequency	1333 MHz				
PCH Information					
Name	LynxPoint				

←→: Select Screen
 ↑↓: Select Item
 Enter: Select
 +/-: Change Opt.
 F1: General Help
 F2: Previous Values
 F3: Optimized Defaults
 F4: Save & Exit
 ESC: Exit

Version 2.17.1246. Copyright (C) 2016 American Megatrends, Inc.



Aptio Setup Utility - Copyright (C) 2016 American Megatrends, Inc.					
Main	Advanced	Chipset	Boot	Security	Save & Exit
Memory RC Version		1.8.0.0		Set the Time. Use Tab to switch between Time elements.	
Total Memory		4096 MB (DDR3)			
Memory Frequency		1333 MHz			
PCH Information					
Name		LynxPoint			
PCH SKU		Q87			
Stepping		05/C2			
LAN PHY Revision		N/A			
ME FW Version		N/A			
ME Firmware SKU		N/A			
SPI Clock Frequency					
DOFR Support		Supported			
Read Status Clock Frequency		50 MHz			
Write Status Clock Frequency		50 MHz			
Fast Read Status Clock Frequency		50 MHz			
System Language		[English]			
System Date		[Thu 03/31/2016]			
System Time		[18:57:47]			
Access Level		Administrator			

←→: Select Screen
 ↑↓: Select Item
 Enter: Select
 +/-: Change Opt.
 F1: General Help
 F2: Previous Values
 F3: Optimized Defaults
 F4: Save & Exit
 ESC: Exit

Version 2.17.1246. Copyright (C) 2016 American Megatrends, Inc.

System Language

Configures the default language of the system.

System Date

The date format is <day>, <month>, <date>, <year>. Day displays a day, from Monday to Sunday. Month displays the month, from January to December. Date displays the date, from 1 to 31. Year displays the year, from 1999 to 2099.

System Time

The time format is <hour>, <minute>, <second>. The time is based on the 24-hour military-time clock. For example, 1 p.m. is 13:00:00. Hour displays hours from 00 to 23. Minute displays minutes from 00 to 59. Second displays seconds from 00 to 59.

Advanced

The Advanced menu allows you to configure your system for basic operation. Some entries are defaults required by the system board, while others, if enabled, will improve the performance of your system or let you set some features according to your preference.



Setting incorrect field values may cause the system to malfunction.

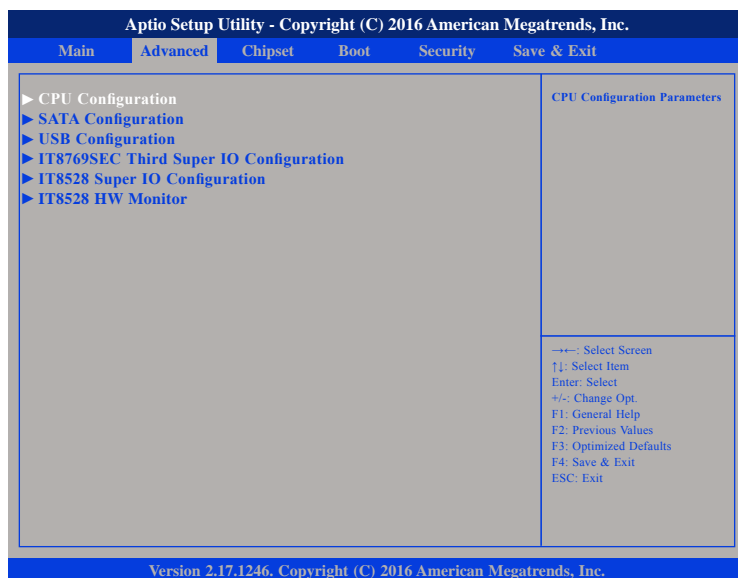

CPU Configuration

This section is used to configure the CPU.

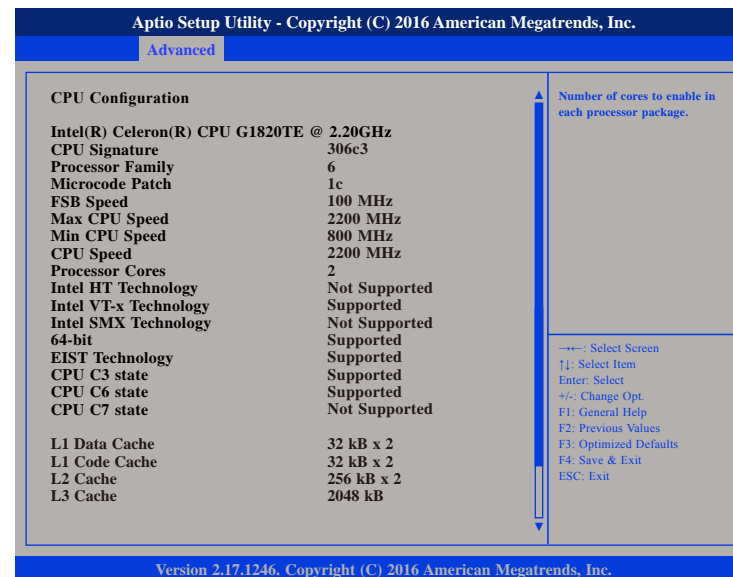

Active Processor Cores

Select the number of cores to enable in each processor package.

Limit CPUID Maximum

The CPUID instruction of some newer CPUs will return a value greater than 3. The default is Disabled because this problem does not exist in the Windows series operating systems. If you are using an operating system other than Windows, this problem may occur. To avoid this problem, enable this field to limit the return value to 3 or lesser than 3.



Intel® Virtualization Technology

Enables or disables Intel Virtualization technology. When enabled, a VMM can utilize the additional hardware capabilities provided by Vanderpool Technology.

EIST

Enables or disables Intel® SpeedStep.

CPU C States

Enables or disables CPU C States support.

SATA Configuration

This section is used to configure the SATA drives.

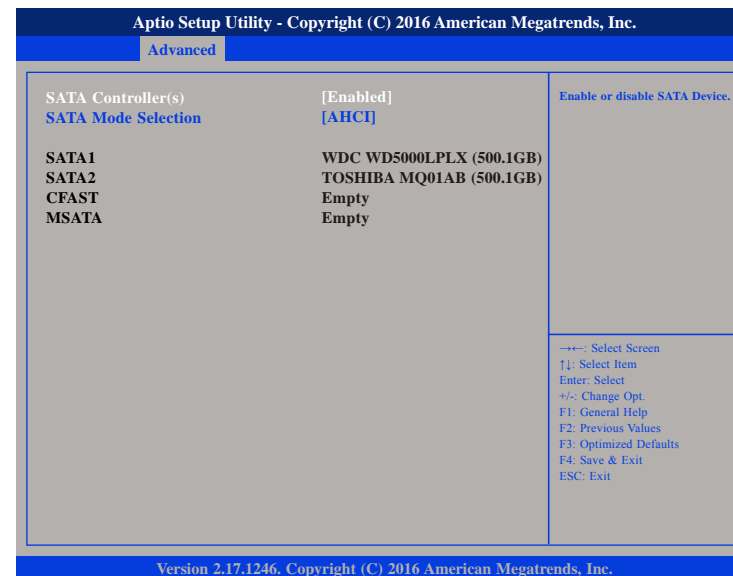

SATA Controller(s)

Enables or disables the SATA controller.

SATA Mode Selection

Configures the SATA mode.

- IDE This option configures the Serial ATA drives as Parallel ATA physical storage device
- AHCI This option configures the Serial ATA drives to use AHCI (Advanced Host Controller Interface). AHCI allows the storage driver to enable the advanced Serial ATA features which will increase storage performance.
- RAID This option allows you to create RAID or Intel Matrix Storage configuration on Serial ATA devices.

USB Configuration

This section is used to configure the USB.



Legacy USB Support

Enabled Enables Legacy USB.

Auto Disables support for Legacy when no USB devices are connected.

Disabled Keeps USB devices available only for EFI applications.

XHCI and EHCI Hand-off

This is a workaround for OSs that do not support XHCI or EHCI hand-off. The XHCI or EHCI ownership change should be claimed by the XHCI or EHCI driver respectively.

Device Reset Time-out

Selects the USB mass storage device start unit command timeout.

IT8769SEC Third Super IO Configuration

This section is used to configure the parallel port of the third super IO.

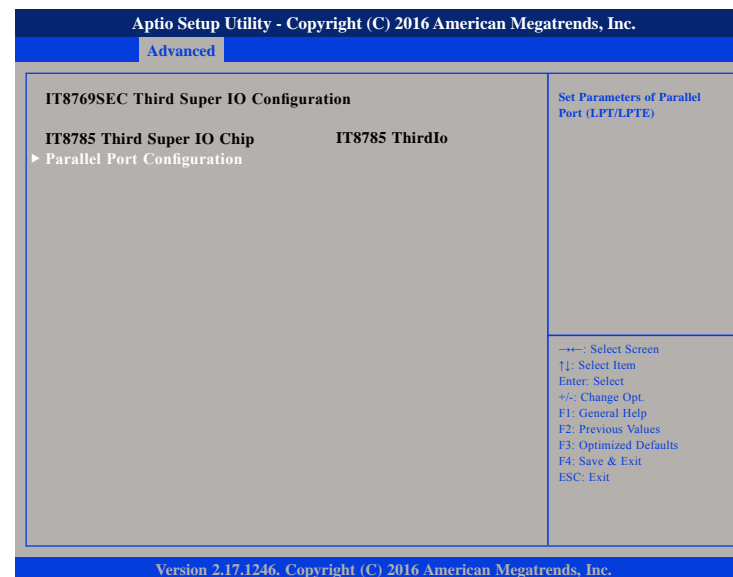

IT8785 Third Super IO Chip

Displays the Super I/O chip used on the board.

Parallel Port Configuration

This section is used to configure the parallel port.



Parallel Port

Enables or disables the parallel port.

Device Mode

Configures the operating mode of the parallel port. The options are Standard Parallel Port Mode, EPP Mode, ECP Mode, EPP Mode & ECP Mode.

IT8528 Super IO Configuration

This section is used to configure serial ports 0 and 1 of the super IO.



IT8528 Super IO Chip

Displays the Super I/O chip used on the board.

Serial Port 0 Configuration

This section is used to configure serial port 0.



Serial Port

Enables or disables the serial port.

Onboard Serial Port 0 Mode

Select this to change the serial port mode to RS232, RS422 or RS485.

Serial Port 1 Configuration

This section is used to configure serial port 1.



Serial Port

Enables or disables the serial port.

Onboard Serial Port 0 Mode

Select this to change the serial port mode to RS232, RS422 or RS485.

IT8528 Hardware Monitor

This section is used to monitor hardware status such as temperature, fan speed and voltages.

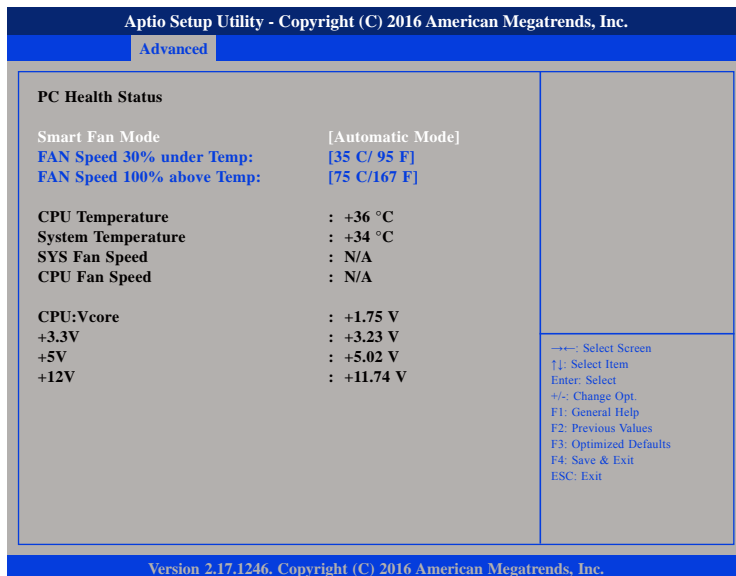

The screenshot shows the 'Advanced' tab of the Aptio Setup Utility. The 'PC Health Status' section displays the following data:

Smart Fan Mode	[Automatic Mode]
FAN Speed 30% under Temp:	[35 C/ 95 F]
FAN Speed 100% above Temp:	[75 C/167 F]
CPU Temperature	: +36 °C
System Temperature	: +34 °C
SYS Fan Speed	: N/A
CPU Fan Speed	: N/A
CPU:Vcore	: +1.75 V
+3.3V	: +3.23 V
+5V	: +5.02 V
+12V	: +11.74 V

Navigation instructions are listed in the bottom right corner:

- ←→: Select Screen
- ↑↓: Select Item
- Enter: Select
- +/-: Change Opt.
- F1: General Help
- F2: Previous Values
- F3: Optimized Defaults
- F4: Save & Exit
- ESC: Exit

Version 2.17.1246. Copyright (C) 2016 American Megatrends, Inc.

Smart Fan Mode

Selects the mode of the fan, the options are Full on Mode and Automatic Mode.

FAN Speed 30% under Temp

Configures the temperature for the fan speed to operate at 30% efficiency.

FAN Speed 100% above Temp

Configures the temperature for the fan speed to operate at 100% efficiency.

CPU Temperature

Detects and displays the current CPU temperature.

System Temperature

Detects and displays the current system temperature.

SYS Fan Speed

Detects and displays the current system fan speed.

CPU Fan Speed

Detects and displays the current CPU fan speed.

VCore

Detects and displays the Vcore CPU voltage.

+3.3V

Detects and displays 3.3V voltage.

+5V

Detects and displays 5V voltage.

+12V

Detects and displays 12V voltage.

Chipset

This section is used to configure the system based on the specific features of the chipset.



Setting incorrect field values may cause the system to malfunction.

PCH-IO Configuration

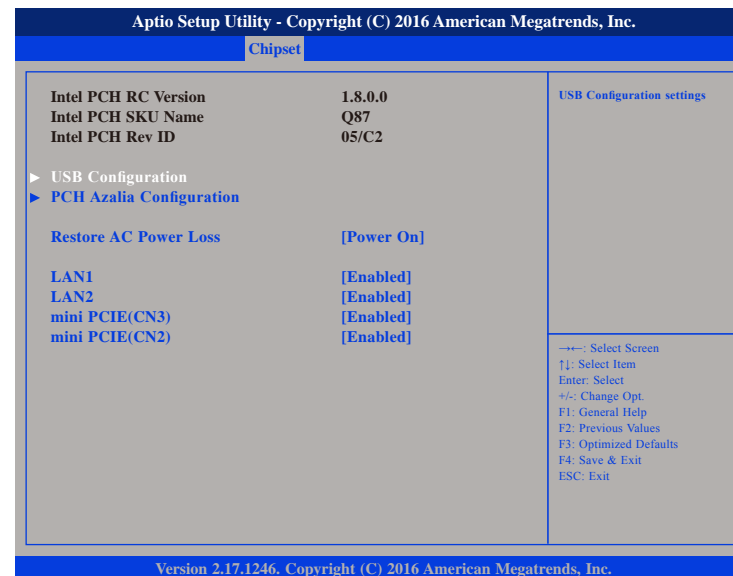

Restore AC Power Loss

Select AC power state when power is re-applied after a power failure.

LAN1 and LAN2

Enables or disables LAN1 and LAN2 controllers.

Mini PCIE (CN3 and CN2)

Enables or disables the mini-PCIe on CN2 and CN3.

USB Configuration

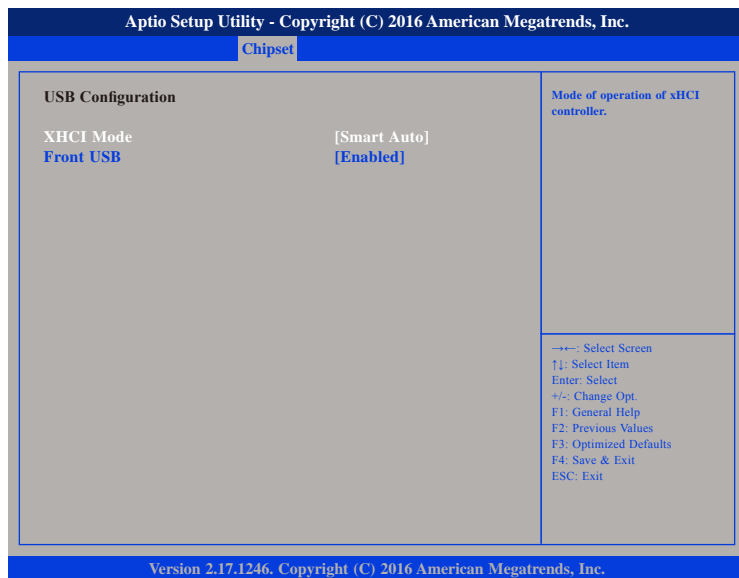

XHCI Mode

Configures the operating mode of the XHCI controller. The options are Smart Auto, Auto, Enabled, Disabled and Manual.

Front USB

Enables or disables front USB connection.

PCH Azalia Configuration



Azalia

Control detection of the Azalia device.

- Disabled Azalia will be unconditionally disabled.
- Enabled Azalia will be unconditionally enabled.
- Auto Azalia will be enabled if present, disabled otherwise.

System Agent (SA) Configuration

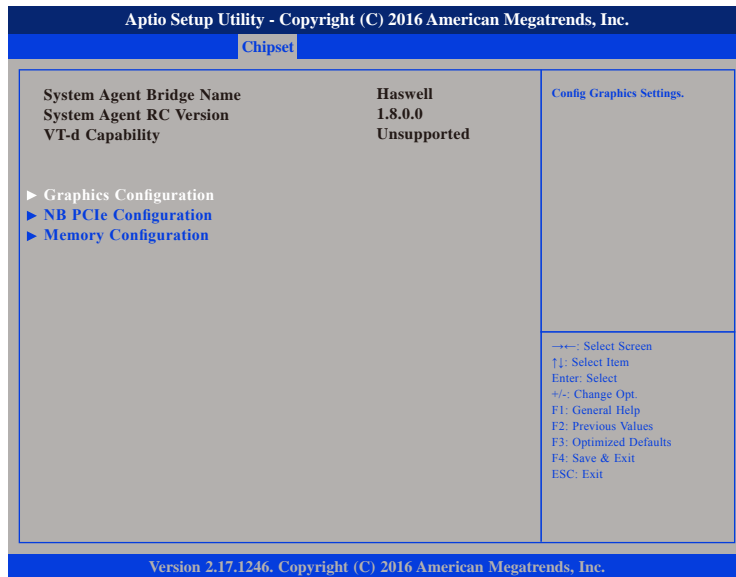

Graphics Configuration

Enters the graphics chip settings sub-menu.

NB PCIe Configuration

Enters the NB PCIe settings sub-menu.

Memory Configuration

Enters the memory settings sub-menu.

Graphics Configuration

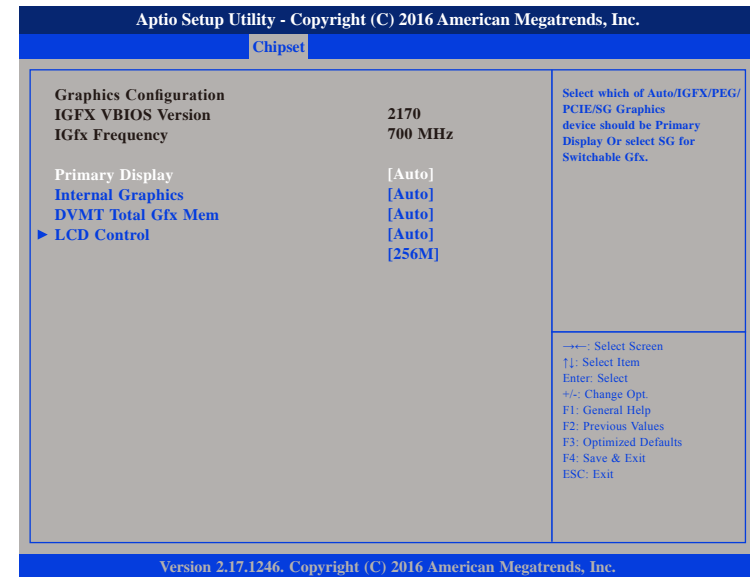

Primary Display

Select which of Auto/IGFX/PEG/PCIe/SG graphics device should be primary display or select SG for switchable GFX.

Internal Graphics

Keep IGD enabled based on the setup options.

DVMT Total Gfx Mem

Select DVMT5.0 Total Graphic Memory size used by the internal graphics device.

LCD Control



Primary IGFX Boot Display

Select the video device which will be activated during POST. This has no effect if external graphics is present. Secondary boot display selection will appear based on your selection. VGA modes will be supported only on primary display.

Secondary IGFX Boot Display

Select the secondary display device.

Active LFP

Select the Active LFP configuration.

No LVDS VBIOS does not enable LVDS.
eDP Port-A LFP driven by Int-DisplayPort encoder from Port-A

Backlight Dimming Control Select

Select the type of backlight dimming control to use. The available options are Embedded Controller and OS.

Backlight

Adjusts the brightness of the backlight.

NB PCIe Configuration

Aptio Setup Utility - Copyright (C) 2016 American Megatrends, Inc.		
Chipset		
NB PCIe Configuration		
PEG0	x8 Gen2	Configure PEG0 B0:D1:F0 Gen1-Gen3.
PEG0 - Gen X	[Auto]	
PEG1	Not Present	
PEG1 - Gen X	[Auto]	
PEG2	Not Present	
PEG2 - Gen X	[Auto]	
Enable PEG	[Enabled]	
		→←: Select Screen ↑↓: Select Item Enter: Select +/-: Change Opt. F1: General Help F2: Previous Values F3: Optimized Defaults F4: Save & Exit ESC: Exit
Version 2.17.1246. Copyright (C) 2016 American Megatrends, Inc.		

PEG0 - Gen X

Configure PEG0 B0:D1:F0 Gen1-Gen3.

PEG1 - Gen X

Configure PEG1 B0:D1:F1 Gen1-Gen3.

PEG2 - Gen X

Configure PEG2 B0:D1:F2 Gen1-Gen3.

Enable PEG

Enables or disables the PEG slot.

Memory Configuration

Aptio Setup Utility - Copyright (C) 2016 American Megatrends, Inc.		
Chipset		
Memory Information		
Memory RC Version	1.8.0.0	
Memory Frequency	1333 MHz	
Total Memory	4096 MB (DDR3)	
Memory Voltage	1.50v	
DIMM#0	Not Present	
DIMM#1	Not Present	
DIMM#2	4096 MB (DDR3)	
DIMM#3	Not Present	
CAS Latency (tCL)	9	
Minimum delay time		
CAS to RAS (tRCDmin)	9	
Row Precharge (tRPmin)	9	
Active to Precharge (tRASmin)	24	
XMP Profile 1	Not Supported	
XMP Profile 2	Not Supported	
		→←: Select Screen ↑↓: Select Item Enter: Select +/-: Change Opt. F1: General Help F2: Previous Values F3: Optimized Defaults F4: Save & Exit ESC: Exit
Version 2.17.1246. Copyright (C) 2016 American Megatrends, Inc.		

Memory Information

Displays the information on the memory installed.

Boot

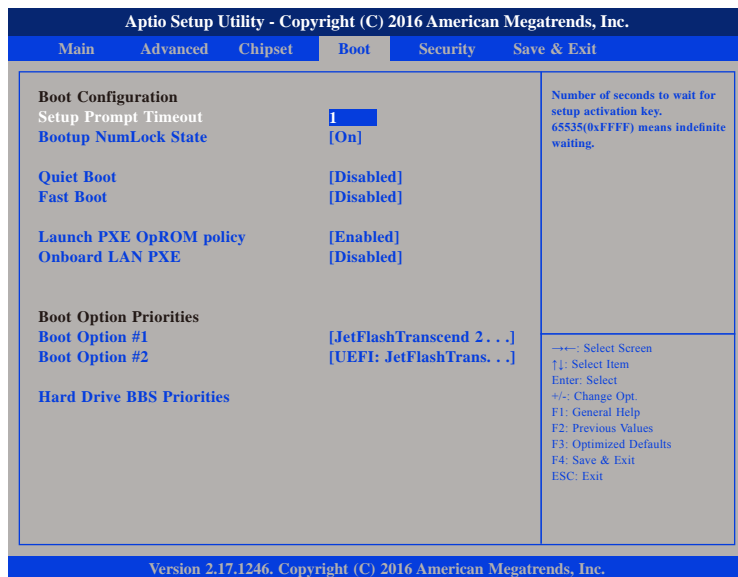

Setup Prompt Timeout

This section configures the number of seconds to wait for the setup activation key. 65535(0xFFFF) denotes indefinite waiting.

Bootup NumLock State

This allows you to determine the default state of the numeric keypad. By default, the system boots up with NumLock on wherein the function of the numeric keypad is the number keys. When set to Off, the function of the numeric keypad is the arrow keys.

Quiet Boot

Enabled Displays OEM logo instead of the POST messages.
 Disabled Displays normal POST messages.

Fast Boot

Enables or disables boot with initialization of a minimal set of devices required to launch active boot option. Has no effect for BBS boot options.

Launch PXE OpROM Policy

Controls the execution of legacy PXE OpROM.

Onboard LAN PXE

Options to disable onboard LAN PXE ROM or enable it for LAN1 or LAN2.

Boot Option Priorities

Adjust the boot sequence of the system. Boot Option #1 is the first boot device that the system will boot from, next will be #2 and so forth.

Hard Drive BBS Priorities

Sets the order of the legacy devices in this group.

Save & Exit

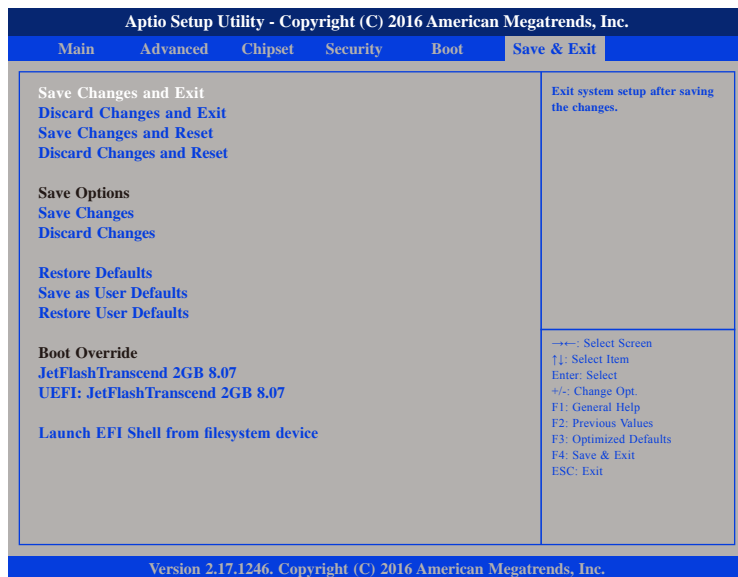

Save Changes and Exit

To save the changes and exit the Setup utility, select this field then press <Enter>. A dialog box will appear. Confirm by selecting Yes. You can also press <F4> to save and exit Setup.

Discard Changes and Exit

To exit the Setup utility without saving the changes, select this field then press <Enter>. You may be prompted to confirm again before exiting. You can also press <ESC> to exit without saving the changes.

Save Changes and Reset

To save the changes and reset, select this field then press <Enter>. A dialog box will appear. Confirm by selecting Yes.

Discard Changes and Reset

To exit the Setup utility and reset without saving the changes, select this field then press <Enter>. You may be prompted to confirm again before exiting.

Save Changes

To save changes and continue configuring the BIOS, select this field then press <Enter>. A dialog box will appear. Confirm by selecting Yes.

Discard Changes

To discard the changes, select this field then press <Enter>. A dialog box will appear. Confirm by selecting Yes to discard all changes made and restore the previously saved settings.

Restore Defaults

To restore the BIOS to default settings, select this field then press <Enter>. A dialog box will appear. Confirm by selecting Yes.

Save as User Defaults

To use the current configurations as user default settings for the BIOS, select this field then press <Enter>. A dialog box will appear. Confirm by selecting Yes.

Restore User Defaults

To restore the BIOS to user default settings, select this field then press <Enter>. A dialog box will appear. Confirm by selecting Yes.

Boot Override

To bypass the boot sequence from the Boot Option List and boot from a particular device, select the desired device and press <Enter>.

Launch EFI Shell From Filesystem Device

Launches the EFI shell.

APPENDIX A: EC COMMAND DOCUMENTATION

General Purpose of EC

ACPI defines a standard hardware and software communications interface between an OS driver and an embedded controller. This allows any OS to provide a standard driver that can directly communicate with an embedded controller in the system, thus allowing other drivers within the system to communicate with and use the resources of system embedded controllers.

Abbreviation

The Input Buffer Full (IBF) flag is set when the host has written a byte of data to the command or data port, but the embedded controller has not yet read it. After the embedded controller reads the status byte and sees the IBF flag set, the embedded controller reads the data port to get the byte of data that the host has written. After the embedded controller reads the data byte, the IBF flag is automatically cleared by hardware. This is the signal to the host that the data has been read by the embedded controller and that the host is free to write more data to the embedded controller.

The Output Buffer Full (OBF) flag is set when the embedded controller has written a byte of data into the command or data port but the host has not yet read it. After the host reads the status byte and sees the OBF flag set, the host reads the data port to get the byte of data that the embedded controller has written. After the host reads the data byte, the OBF flag is cleared automatically by hardware. This signals the embedded controller that the data has been read by the host and the embedded controller is free to write more data to the host.

PM1 (Power Management Channel1) Overview

PWM 1 is LPC IO channel between CPU and embedded controller. The embedded controller contains three registers at two address locations: EC_SC and EC_DATA. The EC_SC, or Embedded Controller Status/Command register, acts as two registers: a status register for reads to this port and a command register for write to this port. The EC_DATA (Embedded Controller Data register) acts as a port for transferring data between the host CPU and the embedded controller.

The status/command register is **0x66**. Data register is **0x62**. These two registers act importantly in EC controlled function.

Note: Some commands are skipped (content with "x") in RW sample code. Because RW runs under Windows 7 and with API interface to display result. For those using EC command in different OS, such as Linux or real-time OS, every command in sequence is needed for complete function command.

1. Digital I/O & EC_GPI/O

1.1 Command Register and Address Description:

Command:

Command	Description
0x80	Read
0x81	Write

Address:

Address	Description
0xA6	EC_GPI/O Register (Bit0-3 = Output, Bit4-7 = Input)
0xA7	Digital I/O Register (Bit0-3 =Output, Bit4-7 = Input)

1.2 Read Description:

This command is to read.

Sequence to read:

Step	Action	Description	RW Sample Code Command
0	Wait IBF clear		x
1	Write 0x80 to 0x66	Send read command	>o 0x66 0x80
2	Wait IBF clear		x
3	Write RAM address to 0x62 port	Send address 0xA6	>o 0x62 0xA6
4	Wait OBF set		x
5	Read 0x62 port	Get data in current address	>i 0x62

1.3 Setting description:

This command is to set.

Step	Action	Description	RW Sample Code Command
0	Wait IBF clear		x
1	Write 0x81 to 0x66	Send write command	>o 0x66 0x81
2	Wait IBF clear		x
3	Write RAM address to 0x62 port	Send address 0xA7	>o 0x62 0xA7
4	Wait IBF clear		x
5	Write data to 0x62 port	Send data in address	>o 0x62 0x01 (Set Output H)

DIO Control

1.4 Command Register and Address Description:

EC controls DIO status by following command:

Command	Description
0x10	Write PIN number into index.
0x11	According index, get GPIO pin status. 1-active, 0-unactive, 0xFF-fail.
0x12	According index, change GPIO pin status. 1-active, 0-unactive.

Status address of DIO:

Address	Description
0x00	DI
0x04	DO

1.5 Read DIO Command Description:

Sequence to Read DIO:

Step	Action	Description	RW Sample Code Command
0	Wait IBF clear		x
1	Write 0x10 to 0x66	Send GPIO index command	>o 0x66 0x10
2	Wait IBF clear		x
3	Write PIN number to 0x62	Write PIN number to index	>o 0x62 0x00
4	Wait OBF set		x
5	Read 0x62 port	If index setup successfully, EC will return pin number. If fail, EC will return 0xFF.	x
6	Wait IBF clear		x
7	Write 0x11 to 0x66	Send read GPIO status command	>o 0x66 0x11
8	Wait OBF set		x
9	Read 0x62 port	EC will return PIN status according to PIN number which you set in index. 1-GPIO is high. 0-GPIO is low. 0xFF-fail.	>i 0x62

1.6 Write DIO Command Description:

Sequence to Write DIO:

Step	Action	Description	RW Sample Code Command
0	Wait IBF clear		x
1	Write 0x10 to 0x66	Send GPIO index command	>o 0x66 0x10
2	Wait IBF clear		x
3	Write PIN number to 0x62	Write PIN number to index	>o 0x62 0x04
4	Wait OBF set		x
5	Read 0x62 port	If index setup successfully, EC will return pin number. If fail, EC will return 0xFF.	x
6	Wait IBF clear		x
7	Write 0x12 to 0x66	Send write GPIO status command	>o 0x66 0x12
8	Wait IBF clear		x
9	Write pin status to 0x62 port	Write 0x01, GPIO pin will be set high. Write 0x00, GPIO pin will be set low.	>o 0x62 0x01 (set to high)

Watchdog

1.7 Command Register and Address Description:

Command for light sensor:

Command	Description
0x89	Reset watchdog time interval
0x28	Start watchdog
0x29	Stop watchdog
0x2A	Reset watchdog

Address for watchdog:

Watchdog is used to setup time interval and also keep event status. Unit time interval is 1ms. Time setting requires a word (8 bit) long length. You can setup watchdog event time from 0 to 0xFFFFFFFF. Write 0xFFFFFFFF to time interval setting means disable watchdog event. So the interval time range is from 0ms to 497 day (0~0xFFFFFFFF).

Address	Description
0x50-0x53	0~0xFFFFFFFF

1.8 Setup Watchdog Time Interval Description:

Sequence to read light sensor:

Step	Action	Description	RW Sample Code Command
0	Wait IBF clear		x
1	Write 0x89 to 0x66	Send read command	>o 0x66 0x89
2	Wait IBF clear		x
3	Write RAM address to 0x62 port	Send watchdog address 0x50~0x53.	>o 0x62 0x50
4	Wait OBF set		x
5	Write watchdog time interval value to 0x62	Values from 0~0xFFFFFFFF, but two bit in each address, please refer to sample code explanation.	>o 0x62 0x90

Sample explanation:

To setup watchdog time interval to 4 seconds, here are the values that should be filled in each address.

4sec = 400ms (decimal) = 190 (hexadecimal)

Address	0x50	0x51	0x52	0x53
Data	0x00	0x00	0x01	0x90

Complete command set sequence:

Further Description	Command	Address	Data
Set watchdog interval, write to address 0x50~0x53 and Data "00000190"	1>o 0x66 0x89	2>o 0x62 0x50	3>o 0x00
	4>o 0x66 0x89	5>o 0x62 0x51	6>o 0x00
	7>o 0x66 0x89	8>o 0x62 0x52	9>o 0x01
	10>o 0x66 0x89	11>o 0x62 0x53	12>o 0x90

1.9 Reset Watchdog Time Interval Description:

This command is used to reset watchdog time.

Sequence to read light sensor:

Step	Action	Description	RW Sample Code Command
0	Wait IBF clear		x
1	Write 0x2A to 0x66	Send reset watchdog command	>o 0x66 0x2A
2	Wait OBF set		x
3	Read 0x62 port	If setup successfully, EC will return 0x03.	x (check 0x03 output on display)

1.10 Start Watchdog Description:

Step	Action	Description	RW Sample Code Command
0	Wait IBF clear		x
1	Write 0x28 to 0x66	Send start watchdog command	>o 0x66 0x28
2	Wait IBF clear		x
3	Write 0x01 to 0x62		>o 0x62 0x01 (check 0x03 output on display)
4	Wait OBF set		x
5	Read 0x62 port	If setup successfully, EC will return 0x01.	x (check 0x01 output on display)

1.11 Stop Watchdog Description:

Step	Action	Description	RW Sample Code Command
0	Wait IBF clear		x
1	Write 0x29 to 0x66	Send stop watchdog command	>o 0x66 0x29
2	Wait OBF set		x
3	Read 0x62 port	If setup successfully, EC will return 0x02.	x (check 0x02 output on display)

2. HW Monitor

2.1 Command Register and Address Description:

Command for HW monitor:

Command	Description
0x80	Read

Address for HW monitor:

Address	Description
0xB3-0xB4	12V (MSB: 0xB3 LSB: 0xB4) (Decimal point two)
0xB5-0xB6	5V (MSB: 0xB5 LSB: 0xB6) (Decimal point two)
0xB7-0xB8	3V (MSB: 0xB7 LSB: 0xB8) (Decimal point two)
0xB9-0xBA	VCODE (MSB: 0xB9 LSB: 0xBA) (Decimal point two)
0xBB-0xBC	TEMP (MSB: 0xBB LSB: 0xBC)

2.2 Read HW Monitor Description:

This command is to read HW monitor.

Sequence to read light sensor:

Step	Action	Description	RW Sample Code Command
0	Wait IBF clear		x
1	Write 0x80 to 0x66	Send read command	>o 0x66 0x80
2	Wait IBF clear		x
3	Write RAM address to 0x62 port	Send HW monitor address 0xB3~0xC0.	>o 0x62 0xB3
4	Wait OBF set		x
5	Read 0x62 port	Get HW monitor data in current address	>i 0x62

APPENDIX B: TRIPLE DISPLAY SETTINGS

1. In the Intel® HD Graphics Control Panel menu, click **Display**.

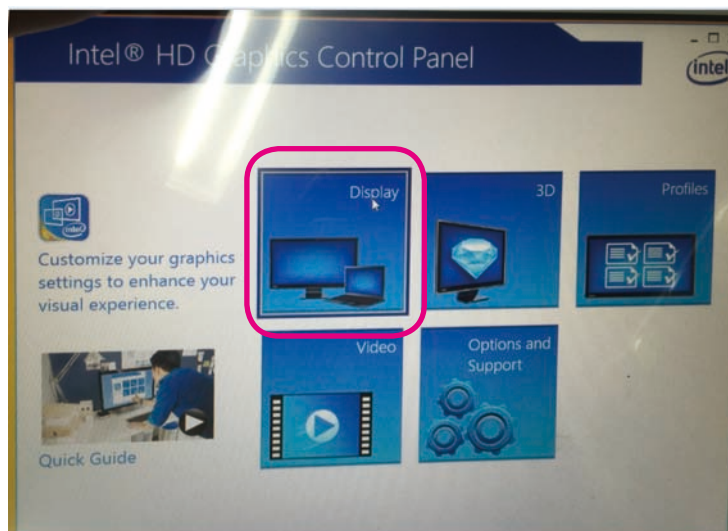

2. Click on the **Display** drop-down menu.

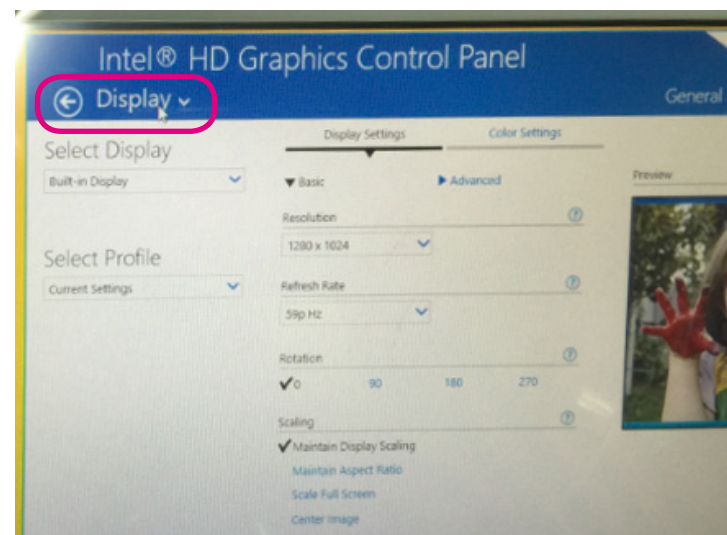

3. Select **Multiple Displays** to enter the setup screen for the three monitors.

