

Neosys Technology Inc.

Nuvo-8208GC Series

User Manual

Revision 1.0

Table of Contents

Table of Contents	2
Legal Information	4
Contact Information	5
Declaration of Conformity	5
Copyright Notice	6
Safety Precautions	7
Battery Warning	7
Service and Maintenance	8
ESD Precautions	8
Restricted Access Location	8
About This Manual	9
1 Introduction	
1.1 Product Specifications.....	11
1.1.1 Nuvo-8208GC Specifications	11
1.2 Nuvo-8208GC Dimension.....	13
1.2.1 Nuvo-8208GC I/O Panel View	13
1.2.2 Nuvo-8208GC Ignition/ Dual 4-Pin Terminal Block Panel View	14
1.2.3 Nuvo-8208GC Top Panel View	15
1.2.4 Nuvo-8208GC Hot-swap Panel View	15
1.2.5 Nuvo-8208GC Bottom View	16
1.2.6 Nuvo-8208GC Wall-mount Dimension	16
2 System Overview	
2.1 Nuvo-8208GC Packing List.....	17
2.2 External I/O Panel.....	18
2.2.1 Power Button	20
2.2.2 4-pole 3.5mm Speaker-out/ Microphone-in Jack	21
2.2.3 DisplayPort	22
2.2.4 Reset Button	23
2.2.5 LED Indicators	24
2.2.6 DVI Port	25
2.2.7 VGA Port	26
2.2.8 USB3.1 Gen 2 Port	27
2.2.9 Gigabit Ethernet Port	28
2.2.10 USB3.1 Gen 1 Port	29
2.2.11 COM Port	30
2.3 Ignition/ Dual 4-Pin Terminal Block.....	31
2.4 Ignition Control Switch	32
2.5 Internal I/O Functions.....	33
2.5.1 SODIMM DRAM Slot	33
2.5.2 Dual Mode mSATA/ mini-PCIe Socket & Pin Definition	34
2.5.3 M.2 2242 (B Key), Dual-SIM Card Slot & Pin Definition	36
2.5.4 SATA Ports	38
2.5.5 Status LED Output & Remote On/ Off Control and Pin Definition	39
2.5.6 Internal USB Port on Extension Board	40
2.5.7 M.2 2280 (M Key) Slot for NVMe SSD or Optane™ Memory	41
3 System Installation	
3.1 Disassembling the System	44
3.2 Installing Internal Components.....	51
3.2.1 CPU Installation Procedure	51
3.2.2 DDR4 SO-DIMM Installation	54
3.2.3 mPCIe Module, Mini-SIM (2FF) Card and Antennae Installation	56
3.2.4 M.2 2242 (B Key) Module and Micro-SIM (3FF) Card Installation	58

3.2.5	M.2 (M Key) 2280 NVMe SSD or Intel® Optane™ Memory Installation	60
3.2.6	Graphics Card Installation.....	62
3.2.7	HDD/ SSD Installation.....	67
3.2.8	Ethernet Port Panel Screw Holes.....	69
3.3	Installing the System Enclosure	70
3.4	Mounting and Anti-vibration Damping Bracket Installation.....	73
3.5	Powering On the System	75
3.5.1	Powering On Using the Power Button.....	75
3.5.2	Powering On Using Wake-on-LAN.....	76
3.6	Ignition Power Control.....	78
3.6.1	Principles of Ignition Power Control	78
3.6.2	Additional Features of Ignition Power Control.....	79
3.6.3	Wiring Ignition Signal.....	80
3.6.4	Configure your Windows system.....	81
3.6.5	Operation Modes of Ignition Power Control	82

4 System Configuration

4.1	BIOS Settings	85
4.1.1	COM Port Configuration.....	86
4.1.2	COM Port High Speed Mode	87
4.1.3	Primary Display.....	88
4.1.4	SATA Configuration.....	89
4.1.5	Fan Control Configuration.....	91
4.1.6	TPM Availability.....	96
4.1.7	Auto Wake on S5	97
4.1.8	Power On After Power Failure Option	98
4.1.9	Power & Performance (CPU SKU Power Configuration)	99
4.1.10	Wake on LAN Option	100
4.1.11	Boot Menu	101
4.1.12	Boot Type (Legacy/ UEFI).....	103
4.1.13	Position New Boot Device.....	104
4.1.14	Watchdog Timer for Booting.....	105
4.1.15	Legacy/ UEFI Boot Device.....	106
4.2	AMT Configuration	107
4.3	RAID Configuration	108
4.3.1	Legacy Mode RAID Configuration.....	108
4.3.2	UEFI Mode RAID Configuration	114

5 OS Support and Driver Installation

5.1	Operating System Compatibility	124
5.2	Driver Installation	125
5.2.1	Install Drivers Automatically	125
5.2.2	Install Drivers Manually.....	126
5.3	Driver Installation for Watchdog Timer Control.....	127
5.4	Intel® Optane™ Memory BIOS Setup and Driver Installation.....	128

Appendix A Using WDT & DIO

WDT and DIO Library Installation	138
WDT Functions.....	140
InitWDT	140
SetWDT	140
StartWDT	141
ResetWDT	141
StopWDT	141

Legal Information

All Neosys Technology Inc. products shall be subject to the latest Standard Warranty Policy

Neosys Technology Inc. may modify, update or upgrade the software, firmware or any accompanying user documentation without any prior notice. Neosys Technology Inc. will provide access to these new software, firmware or documentation releases from download sections of our website or through our service partners.

Before installing any software, applications or components provided by a third party, customer should ensure that they are compatible and interoperable with Neosys Technology Inc. product by checking in advance with Neosys Technology Inc.. Customer is solely responsible for ensuring the compatibility and interoperability of the third party's products. Customer is further solely responsible for ensuring its systems, software, and data are adequately backed up as a precaution against possible failures, alternation, or loss.

For questions in regards to hardware/ software compatibility, customers should contact Neosys Technology Inc. sales representative or technical support.

To the extent permitted by applicable laws, Neosys Technology Inc. shall NOT be responsible for any interoperability or compatibility issues that may arise when (1) products, software, or options not certified and supported; (2) configurations not certified and supported are used; (3) parts intended for one system is installed in another system of different make or model.

Contact Information

Headquarters
(Taipei, Taiwan)

Neosys Technology Inc.
15F, No.868-3, Zhongzheng Rd., Zhonghe Dist., New Taipei City, 23586, Taiwan
Tel: +886-2-2223-6182 Fax: +886-2-2223-6183 [Email](#), [Website](#)

Americas
(Illinois, USA)

Neosys Technology America Inc.
3384 Commercial Avenue, Northbrook, IL 60062, USA
Tel: +1-847-656-3298 [Email](#), [Website](#)

China

Neosys Technology (China) Ltd.
Room 612, Building 32, Guiping Road 680, Shanghai
Tel: +86-2161155366 [Email](#), [Website](#)

Declaration of Conformity

FCC

This equipment has been tested and found to comply with the limits for a Class A digital device, pursuant to part 15 of the FCC Rules. These limits are designed to provide reasonable protection against harmful interference when the equipment is operated in a commercial environment. This equipment generates, uses, and can radiate radio frequency energy and, if not installed and used in accordance with the instruction manual, may cause harmful interference to radio communications. Operation of this equipment in a residential area is likely to cause harmful interference in which case the user will be required to correct the interference at own expense.

CE

The product(s) described in this manual complies with all applicable European Union (CE) directives if it has a CE marking. For computer systems to remain CE compliant, only CE-compliant parts may be used. Maintaining CE compliance also requires proper cable and cabling techniques.

Copyright Notice

All rights reserved. This publication may not be reproduced, transmitted, transcribed, stored in a retrieval system, or translated into any language or computer language, in any form or by any means, electronic, mechanical, magnetic, optical, chemical, manual or otherwise, without the prior written consent of Neosys Technology, Inc.

Disclaimer

This manual is intended to be used as an informative guide only and is subject to change without prior notice. It does not represent commitment from Neosys Technology Inc. Neosys Technology Inc. shall not be liable for any direct, indirect, special, incidental, or consequential damages arising from the use of the product or documentation, nor for any infringement on third party rights.

Patents and Trademarks

Neosys, the Neosys logo, Expansion Cassette, MezIO™ are registered patents and trademarks of Neosys Technology, Inc.

Windows is a registered trademark of Microsoft Corporation.

Intel®, Core™ are registered trademarks of Intel Corporation

NVIDIA® is a registered trademark of NVIDIA Corporation

All other names, brands, products or services are trademarks or registered trademarks of their respective owners.

Safety Precautions

- Read these instructions carefully before you install, operate, or transport the system.
- Install the system or DIN rail associated with, at a sturdy location
- Install the power socket outlet near the system where it is easily accessible
- Secure each system module(s) using its retaining screws
- Place power cords and other connection cables away from foot traffic. Do not place items over power cords and make sure they do not rest against data cables
- Shutdown, disconnect all cables from the system and ground yourself before touching internal modules
- Ensure that the correct power range is being used before powering the device
- Should a module fail, arrange for a replacement as soon as possible to minimize down-time
- If the system is not going to be used for a long time, disconnect it from mains (power socket) to avoid transient over-voltage

Battery Warning

- Batteries are at risk of exploding if incorrectly installed.
- Do not attempt to recharge, force open, or heat the battery.
- Replace the battery only with the same or equivalent type recommended by the manufacturer.

Caution!



Service and Maintenance

- ONLY qualified personnel should service the system
- Shutdown the system, disconnect the power cord and all other connections before servicing the system
- When replacing/ installing additional components (expansion card, memory module, etc.), insert them as gently as possible while assuring proper connector engagement

ESD Precautions

- Handle add-on module, motherboard by their retention screws or the module's frame/ heat sink. Avoid touching the PCB circuit board or add-on module connector pins
- Use a grounded wrist strap and an anti-static work pad to discharge static electricity when installing or maintaining the system
- Avoid dust, debris, carpets, plastic, vinyl and styrofoam in your work area.
- Do not remove any module or component from its anti-static bag before installation

Restricted Access Location

The controller is intended for installation only in the certain environment where both these condition apply:

- Access can only be gained by SERVICE PERSONS or by USERS who have been instructed about the reasons for the restrictions applied to the location and about any precautions that shall be taken
- Access is through the use of a TOOL or lock and key, or other means of security, and is controlled by the authority responsible for the location.

About This Manual

This manual introduces Neosys Nuvo-8208GC series featuring Intel® 9th/ 8th Gen Core™ i hexa/ octa core 35W/ 65W LGA1151 processors and dual graphics cards. The Nuvo-8208GC system supports dual 250W NVIDIA® graphics cards for the advanced inference capabilities.

The guide also demonstrates the system's installation procedures.

Revision History

Version	Date	Description
1.0	Dec. 2019	Initial release

1 Introduction

Nuvo-8208GC is powered by Intel® Xeon® E or 9th/ 8th Gen Core CPU and Intel® C246 chipset; it has powerful computing power to support dual 250W graphics cards. In addition to the dual x16 PCIe slots for GPU installation, Nuvo-8208GC has two other x8 PCIe slots and one x4 PCIe slot for expansion cards to extend function sets like data collection, analytics, and communication.



It accepts 8~35V wide-range DC input and handles heavy power requirements from dual 250W graphics cards. Along with built-in ignition control, it's feasible for vehicle deployment and operate via the car's electrical system.

Nuvo-8208GC features Neosys' patented heat dissipation design (* R.O.C Patent No. M534371) which can effectively dissipate the heat generated by GPU, so it can function under 100% load and wide temperature settings ranging from -25°C to 60°C.

Paired with Neosys' damping brackets and patent-pending GPU press bar, Nuvo-8208GC can be securely positioned and withstand various harsh conditions.

Nuvo-8208GC features front-accessible I/O design. It has 2x GbE, 4x USB3.1 Gen2, 4x USB3.1 Gen1, 1x UBS2.0, 1x VGA, 1x DVI-D, 1x DisplayPort, and 2x COM. USB 3.1 Gen1/ Gen2 ports feature screw-lock mechanisms for securing cable connections. In addition, Nuvo-8208GC incorporates two hot-swappable 2.5" trays for easy HDD/ SSD replacement and an M.2 2280 NVMe socket for the ultimate disk performance.

1.1 Product Specifications

1.1.1 Nuvo-8208GC Specifications

System Core	
Processor	Supporting Intel® Xeon® E and 9 th / 8 th Gen Core i CPU (LGA1151 socket) Intel® Xeon® Processor E-2278GE (8C/ 16T) Intel® Xeon® Processor E-2278GEL (8C/ 16T) Intel® Xeon® Processor E-2176G Intel® Core™ i7-9700E/ i7-9700TE Intel® Core™ i7-8700/ i7-8700T Intel® Core™ i5-9500E/ i5-9500TE Intel® Core™ i5-8500/ i5-8500T
Chipset	Intel® C246 Platform Controller Hub
Graphics	Independent GPU via x16 PEG port, or integrated Intel® UHD Graphics 630
Memory	Up to 128 GB ECC/ non-ECC DDR4 2133 SDRAM (four SODIMM slots)
AMT	Supports AMT 12.0
TPM	Supports TPM 2.0
I/O Interface	
Ethernet	1x Gigabit Ethernet port by Intel® I219-LM 1x Gigabit Ethernet port by Intel® I210-IT
Native Video	1x VGA connector, supporting 1920 x 1200 resolution 1x DVI-D connector, supporting 1920 x 1200 resolution 1x DisplayPort connector, supporting 4096 x 2304 resolution
Serial Port	2x software-programmable RS-232/ 422/ 485 ports (COM1/ COM2)
USB	4x USB 3.1 Gen2 (10 Gbps) ports 4x USB 3.1 Gen1 (5 Gbps) ports 1x USB 2.0 ports (internal for dongle use)
Audio	1x 3.5mm jack for speaker-output and microphone-input
Storage Interface	
SATA	2x hot-swappable HDD trays for 2.5" HDD/ SSD installation
M.2	1x M.2 2280 M key socket (PCIe Gen3 x4) for NVMe SSD or Intel® Optane™ memory installation
mSATA	2x full-size mSATA port (mux with mini-PCIe)
Expansion Bus	
PCI Express	2x PCIe x16 slot@Gen3, 8-lanes 2x PCIe x8 slots@Gen3, 4-lanes

	1x PCIe x4 slot@Gen3, 1-lane
M.2	2x M.2 2242 B key socket with dual front-accessible SIM sockets, supporting dual SIM mode with selected M.2 LTE module
Mini-PCIe	2x full-size mini PCI Express socket
Power Supply	
DC Input	2x 4-pin pluggable terminal block for 8~35V DC input and 1x 3-pin ignition control */ **
Mechanical	
Dimension	235 mm (W) x 360 mm (D) x 185.6 mm (H)
Weight	~ 8.6Kg
Mounting	Wall-mounting with damping brackets
Environmental	
Operating temperature	with 35W CPU and dual NVIDIA® 250W GPU -25°C ~ 60°C **** with >= 65W CPU and dual NVIDIA® 250W GPU -25°C ~ 60°C **** (configured as 35W TDP mode) -25°C ~ 50°C ***/ **** (configured as 65W TDP mode)
Storage temperature	-40°C ~85°C
Humidity	10%~90% , non-condensing
Vibration	Operating, MIL-STD-810G, Method 514.6, Category 4; 3Grms, 5-500Hz 3 Axes
Shock	Operating, MIL-STD-810G, Method 516.6, Procedure I, functional shock=20g
EMC	CE/ FCC Class A, according to EN 55024 & EN 55032

* When NVIDIA® graphics card is used (single or dual), DC input should be greater than 12V.

** Max current for DC input is 30A (per PWR pin) and max power consumption for the system is 1000W.

*** For i7-8700 and i7-9700E running at 65W mode, the highest operating temperature shall be limited to 50°C and thermal throttling may occur when sustained full-loading applied. Users can configure CPU power in BIOS to obtain higher operating temperature.

**** For sub-zero operating temperature, a wide temperature HDD drive or Solid State Disk (SSD) is required.

1.2 Nuvo-8208GC Dimension

 **NOTE**
All measurements are in millimeters (mm).

1.2.1 Nuvo-8208GC I/O Panel View

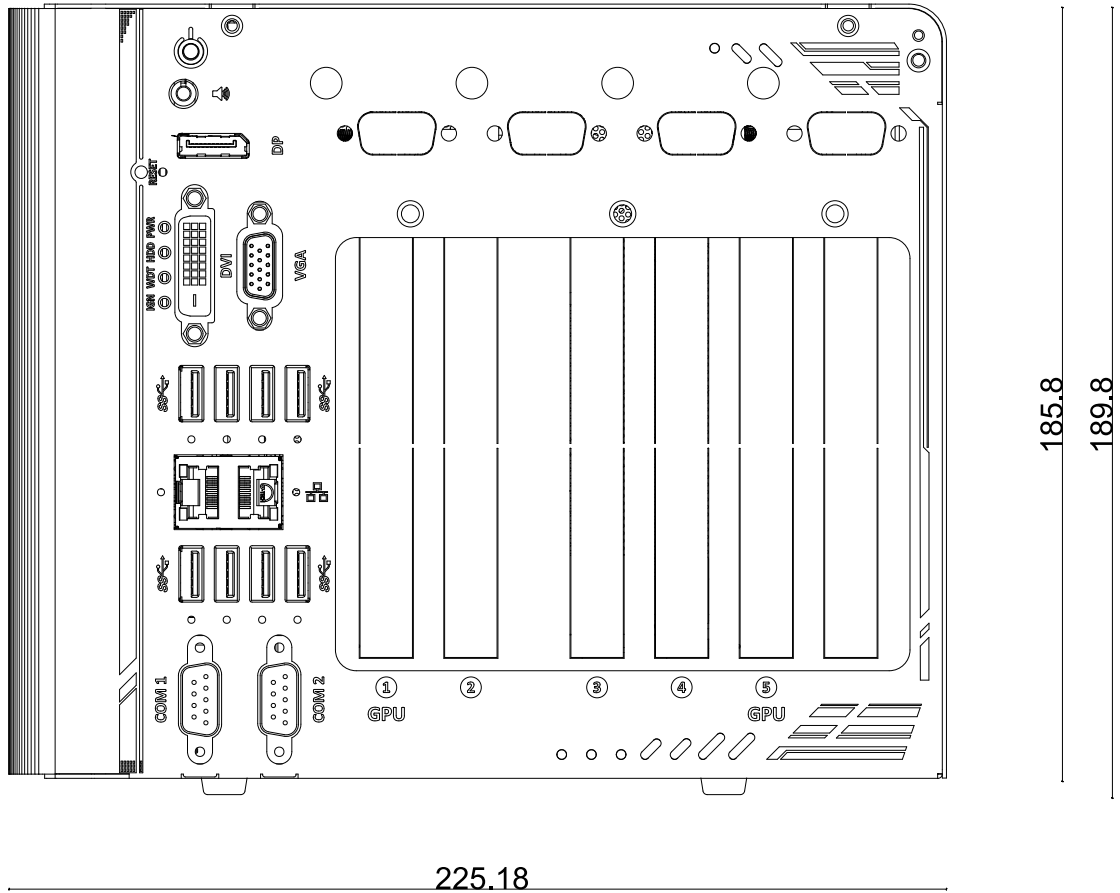

1.2.2 Nuvo-8208GC Ignition/ Dual 4-Pin Terminal Block Panel View

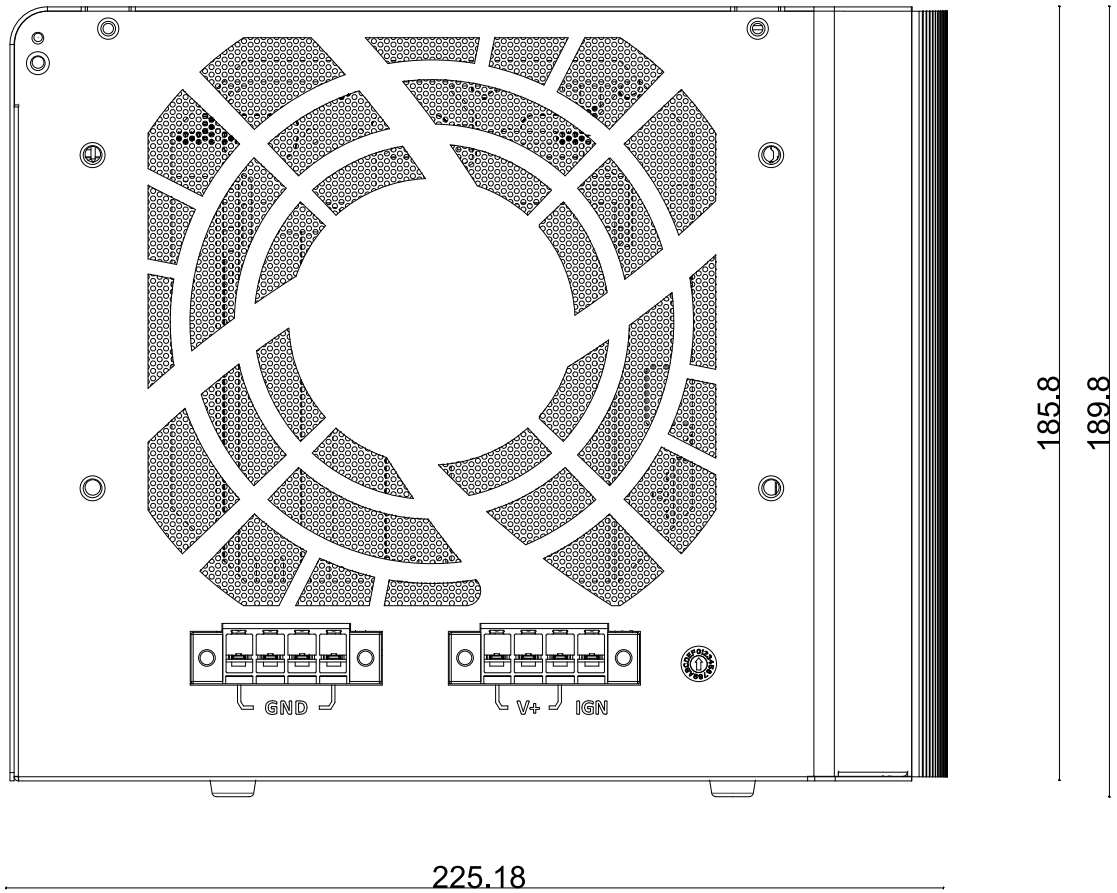

1.2.3 Nuvo-8208GC Top Panel View

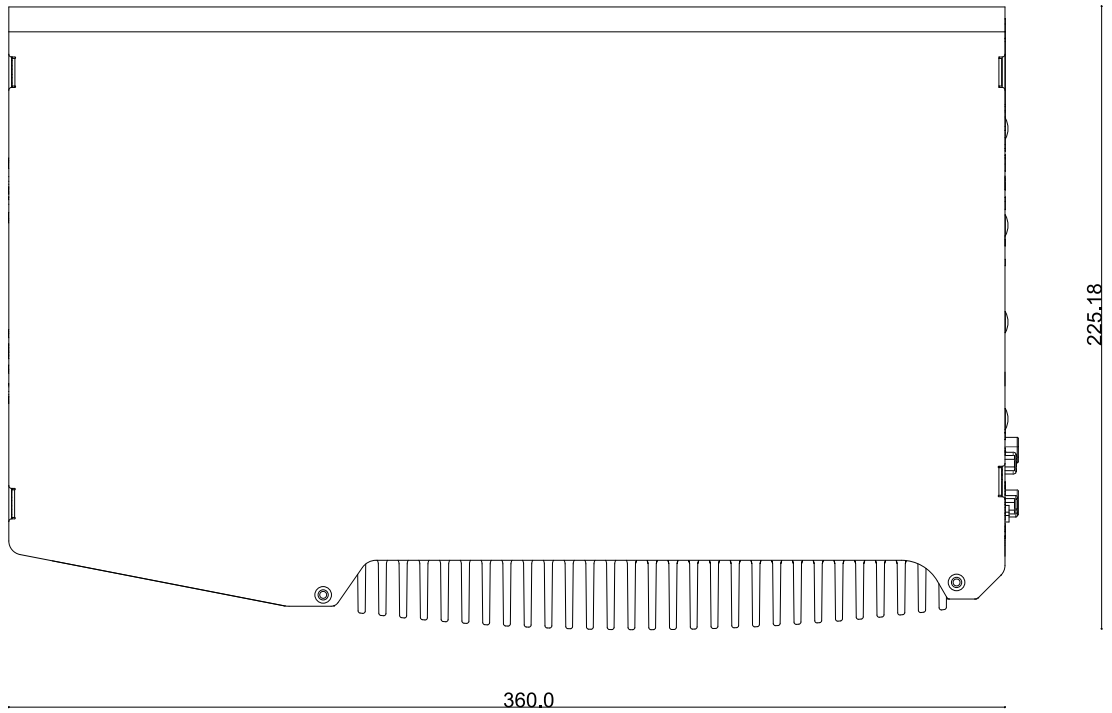

1.2.4 Nuvo-8208GC Hot-swap Panel View

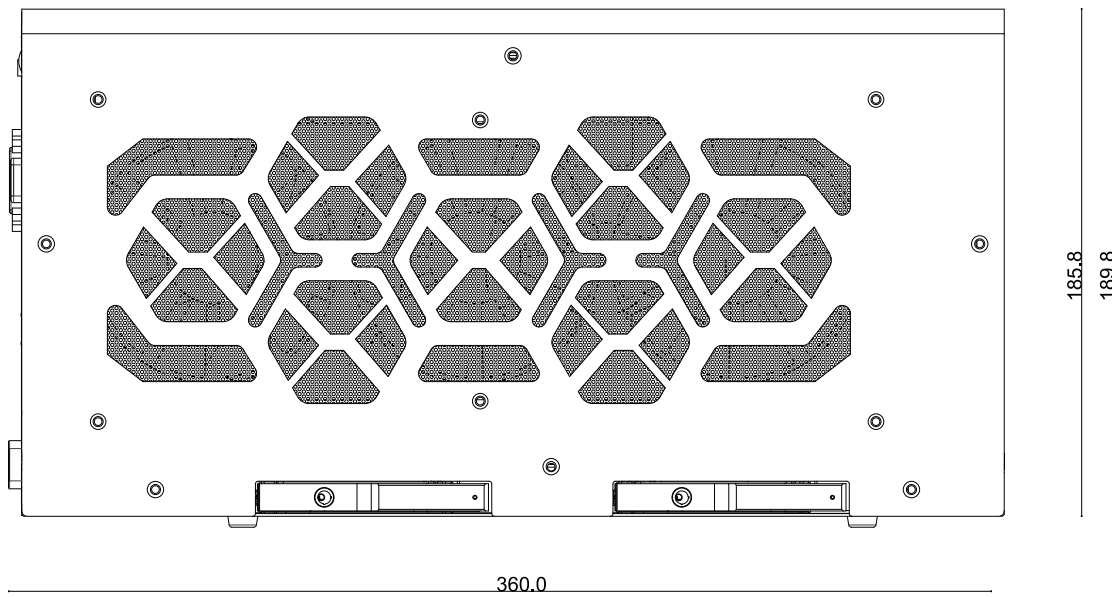

1.2.5 Nuvo-8208GC Bottom View

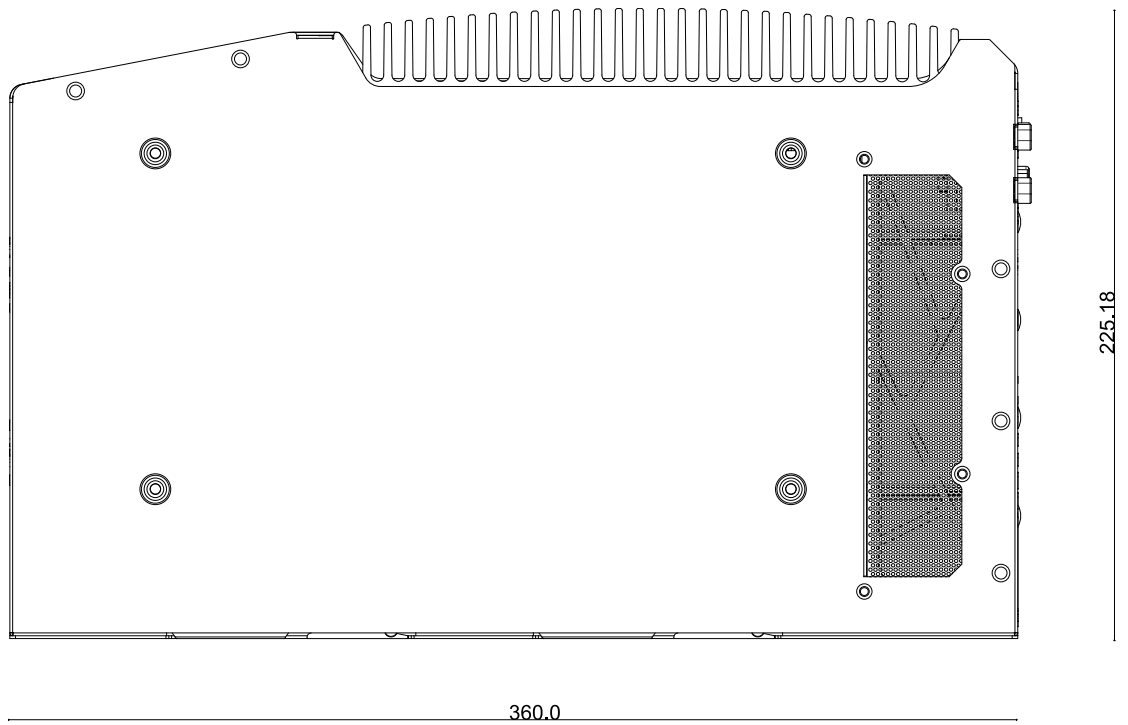

1.2.6 Nuvo-8208GC Wall-mount Dimension

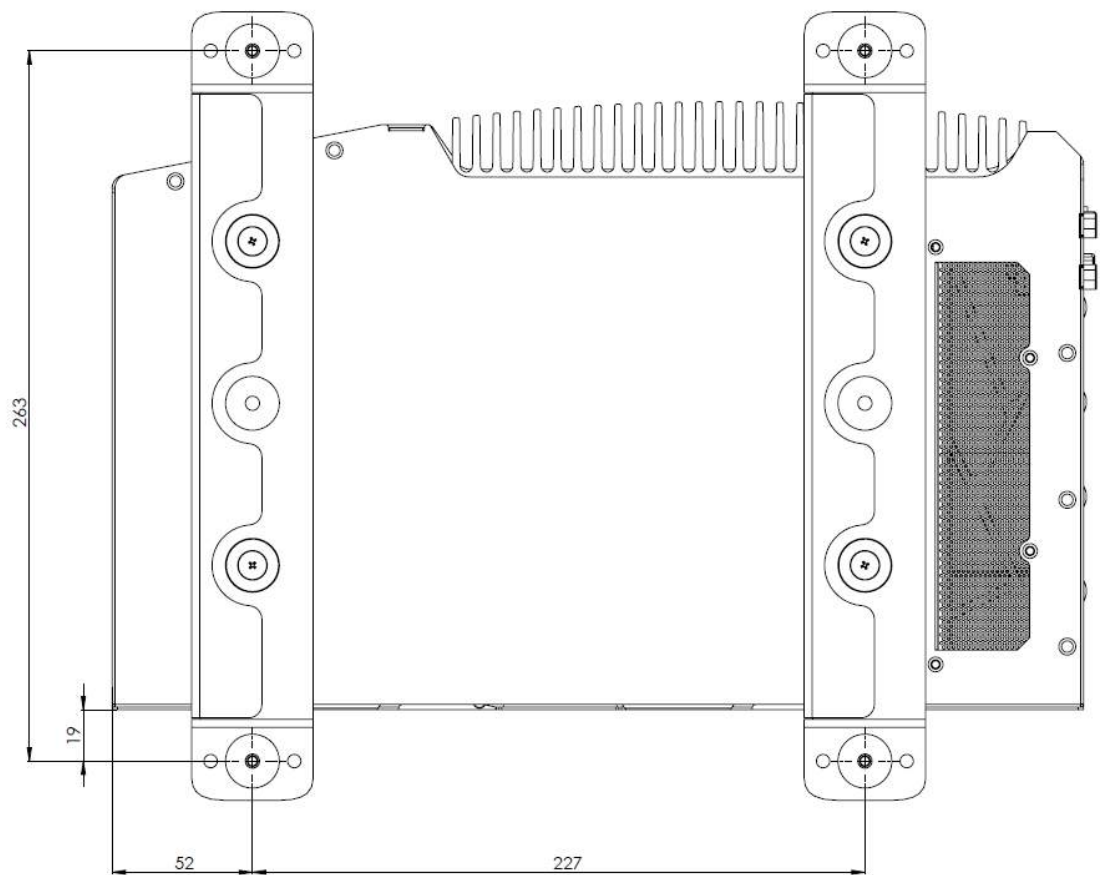

2 System Overview

Upon receiving and unpacking your Nuvo-8208GC system, please check immediately if the package contains all the items listed in the following table. If any item(s) are missing or damaged, please contact your local dealer or Neosys Technology.

2.1 Nuvo-8208GC Packing List



System Pack	Nuvo-8208GC	Qty
1	Nuvo-8208GC system (If you ordered CPU/ RAM/ HDD, please verify these items)	1
2	Accessory box, which contains <ul style="list-style-type: none"> ● CPU bracket ● Neosys drivers & utilities DVD ● Wall-mount bracket (with 6 anti-vibration grommet) ● Hex key ● 4-pin power terminal block ● Anti-vibration grommet ● Screw pack ● 16cm graphics card power cable <ul style="list-style-type: none"> ■ 6-pin to 6-pin ■ 6-pin to 8-pin ■ 8-pin to 8-pin ● 25cm graphics card power cable <ul style="list-style-type: none"> ■ 6-pin to 6-pin ■ 6-pin to 8-pin ■ 8-pin to 8-pin 	1 1 2 2 2 4 1 1 1 1 1 1 1 1 1

2.2 External I/O Panel

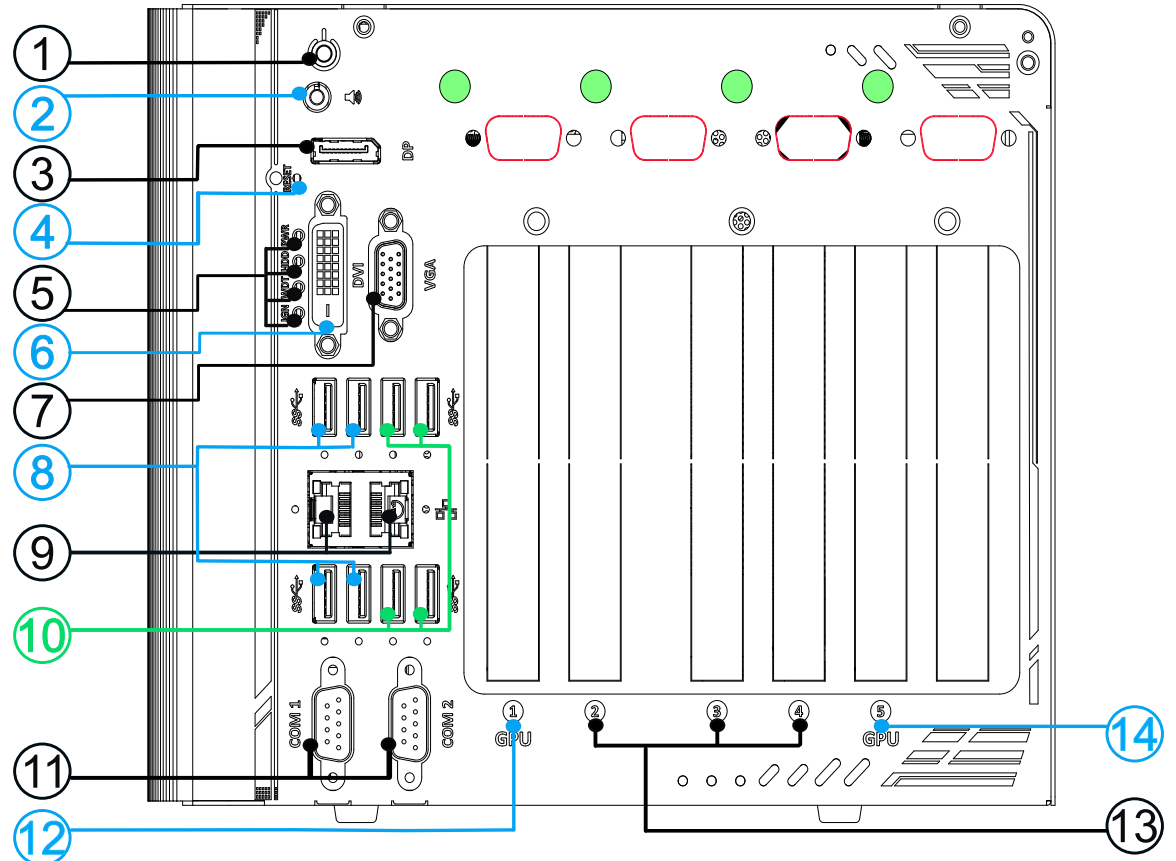
The Nuvo-8208GC I/O panel features Gen2/ Gen1 USB3.0, DisplayPort, DVI, VGA, dual Ethernet and COM ports.

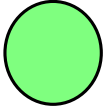

No.	Item	Description
1	Power button	Use this button to turn on or shutdown the system.
2	4-pole 3.5mm speaker-out/ microphone-in jack	3.5mm jack for speaker-output and microphone-input.
3	DisplayPort	Support display resolutions up to 4096 x 2304. Compatible with HDMI/ DVI via respective adapter/ cable (resolution may vary).
4	Reset button	Use this button to manual reset the system.
5	LED indicator	From top to bottom, the four system LEDs are PWR (system power), HDD (hard disk drive), WDT (watchdog timer) and IGN (ignition control).
6	DVI port	DVI-D output supports resolution up to 1920x1200@60Hz and is compatible with other digital connections via an adapter.
7	VGA port	VGA output supports resolution up to 1920x1200@60Hz
8	USB 3.1 Gen2	USB3.1 Gen 2 port (SuperSpeed+) offers up to 10Gbps, twice the

	port	bandwidth over existing SuperSpeed USB3.1 Gen. 1 connection. It is also backwards compatible with USB3.0 and USB2.0
9	GbE port	1x Gigabit Ethernet port by Intel® I219-LM 1x Gigabit Ethernet port by Intel® I210-IT
10	USB 3.1 Gen1 port	USB3.1 Gen 1 offers up to 5Gbps of data-throughput performance
11	COM port	The software-selectable RS-232/422/485 ports. The operation mode of COM1 and COM2 can be set in BIOS.
12	GPU slot	PCIe x16 slot @ Gen3, 8-lanes expansion slot
13	PCIe slots	2x PCIe x8 slots @ Gen3, 4-lanes expansion slot 1x PCIe x4 slot @ Gen3, 1-lane expansion slot
14	GPU slot	PCIe x16 slot @ Gen3, 8-lanes expansion slot
		Reserved antenna opening
		Reserved DB9 connector opening

2.2.1 Power Button

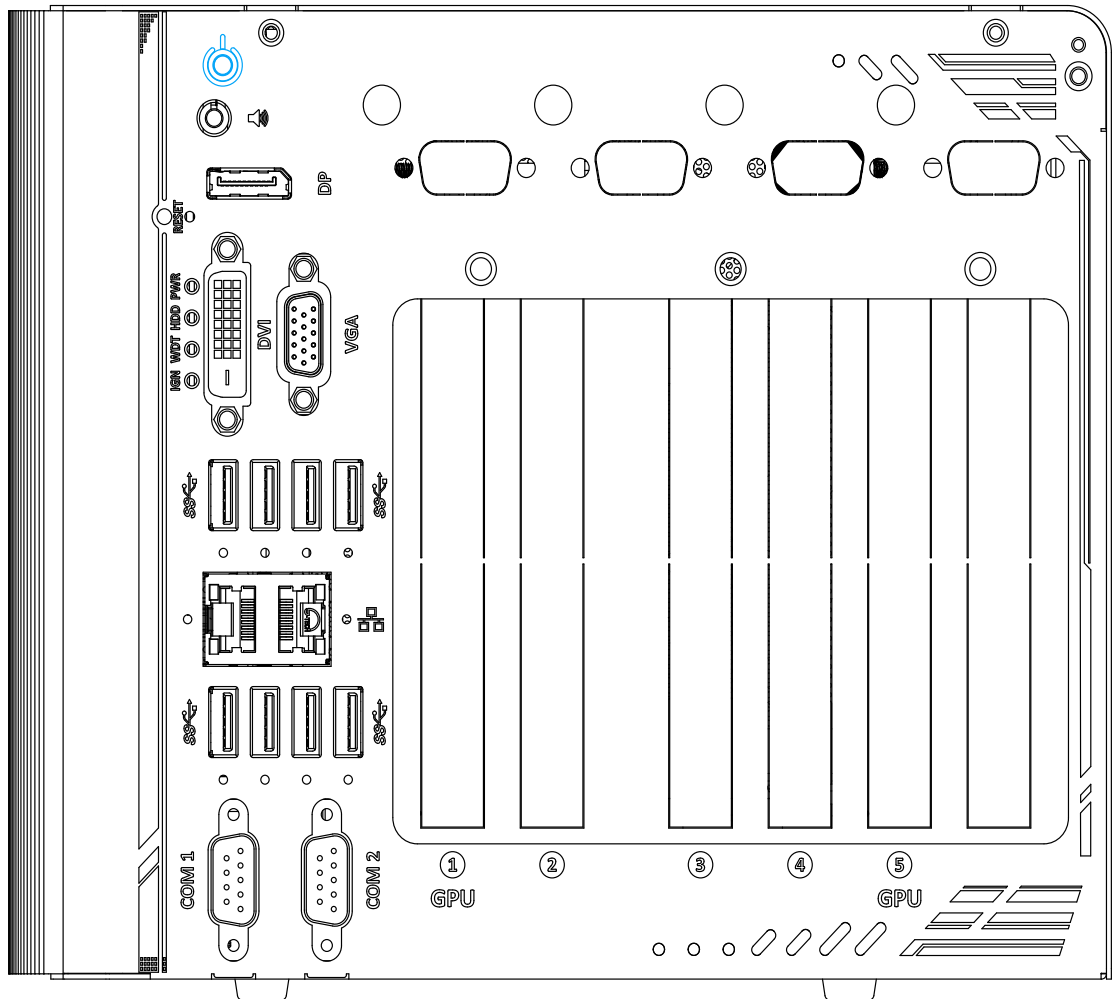

The power button is a non-latched switch for ATX mode on/off operation. To turn on the system, press the power button and the PWR LED should light-up green. To turn off the system, issuing a shutdown command in OS is preferred, or you can simply press the power button. To force shutdown when the system freezes, press and hold the power button for 5 seconds. Please note that there is a 5-second interval between on/off operations (i.e. once the system is turned off, there is a 5-second wait before you can power-on the system).

2.2.2 4-pole 3.5mm Speaker-out/ Microphone-in Jack

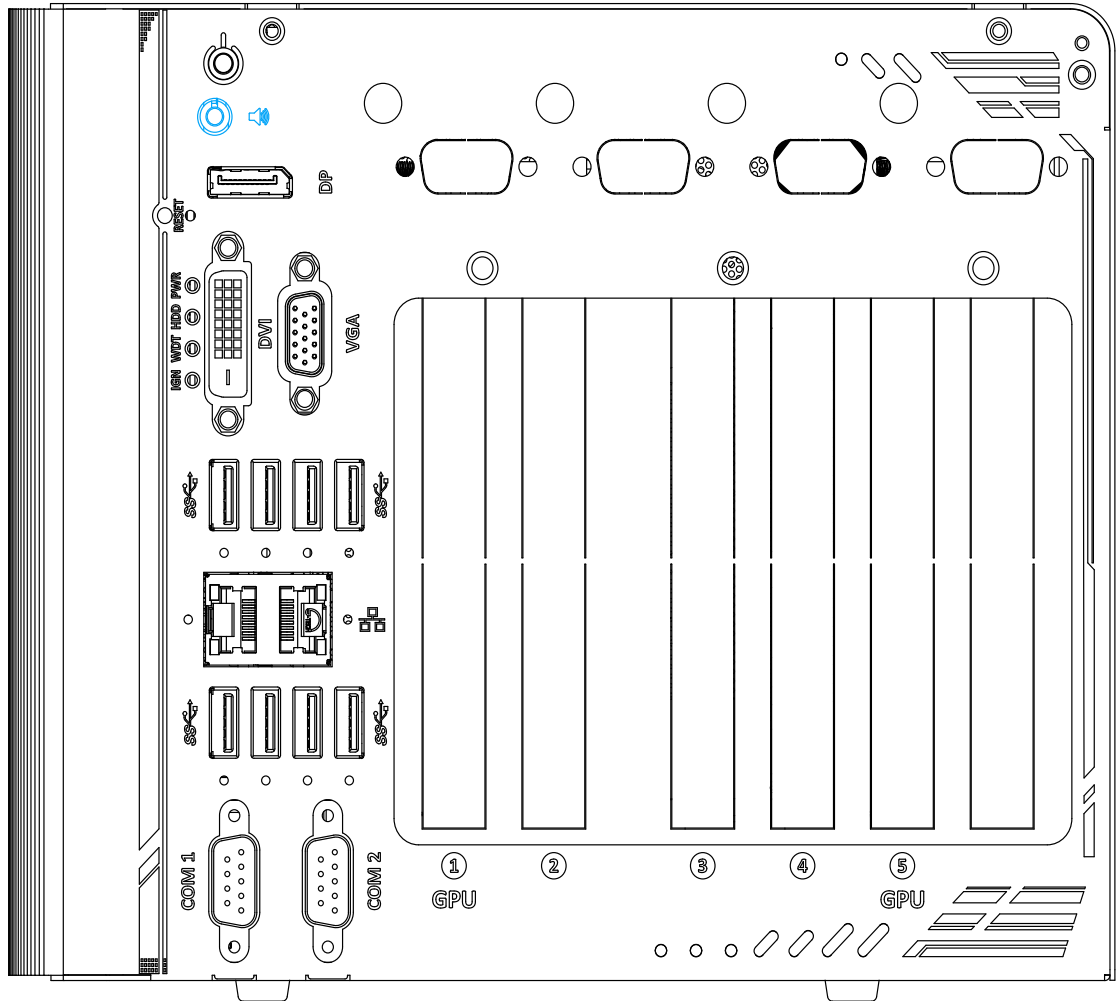

The system audio function uses high definition audio. There is a female 4-pole  audio jack for headphone (speaker) output and microphone input. To utilize the audio function in Windows, you need to install corresponding drivers for both Intel® C246 chipset and audio device drivers.

2.2.3 DisplayPort

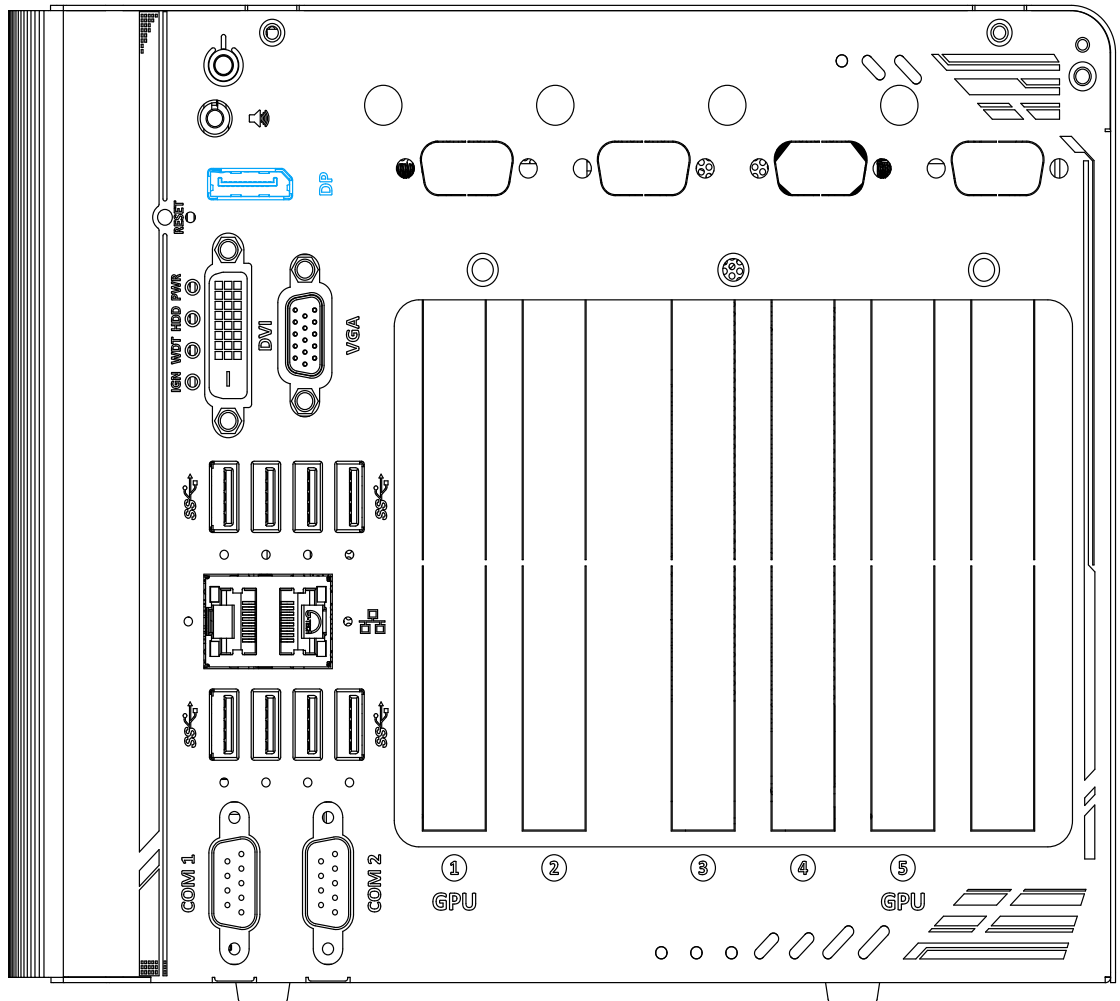

The DisplayPort (DP) output is a digital display interface that mainly connect video source and carry audio to a display device. When connecting a DP, it can deliver up to 4K UHD (4096 x 2304) in resolution. The system is designed to support passive DP adapter/ cable. You can connect to other display devices using DP-to-HDMI cable or DP-to-DVI cable.



DP-to-HDMI



DP-to-DVI

The system supports triple independent display outputs by connecting display devices to VGA, DVI and DisplayPort connection. To support multiple display outputs and achieve best DisplayPort output resolution in Windows, you need to install corresponding graphics drivers. Please refer to section [OS Support and Driver Installation](#) for details.

2.2.4 Reset Button

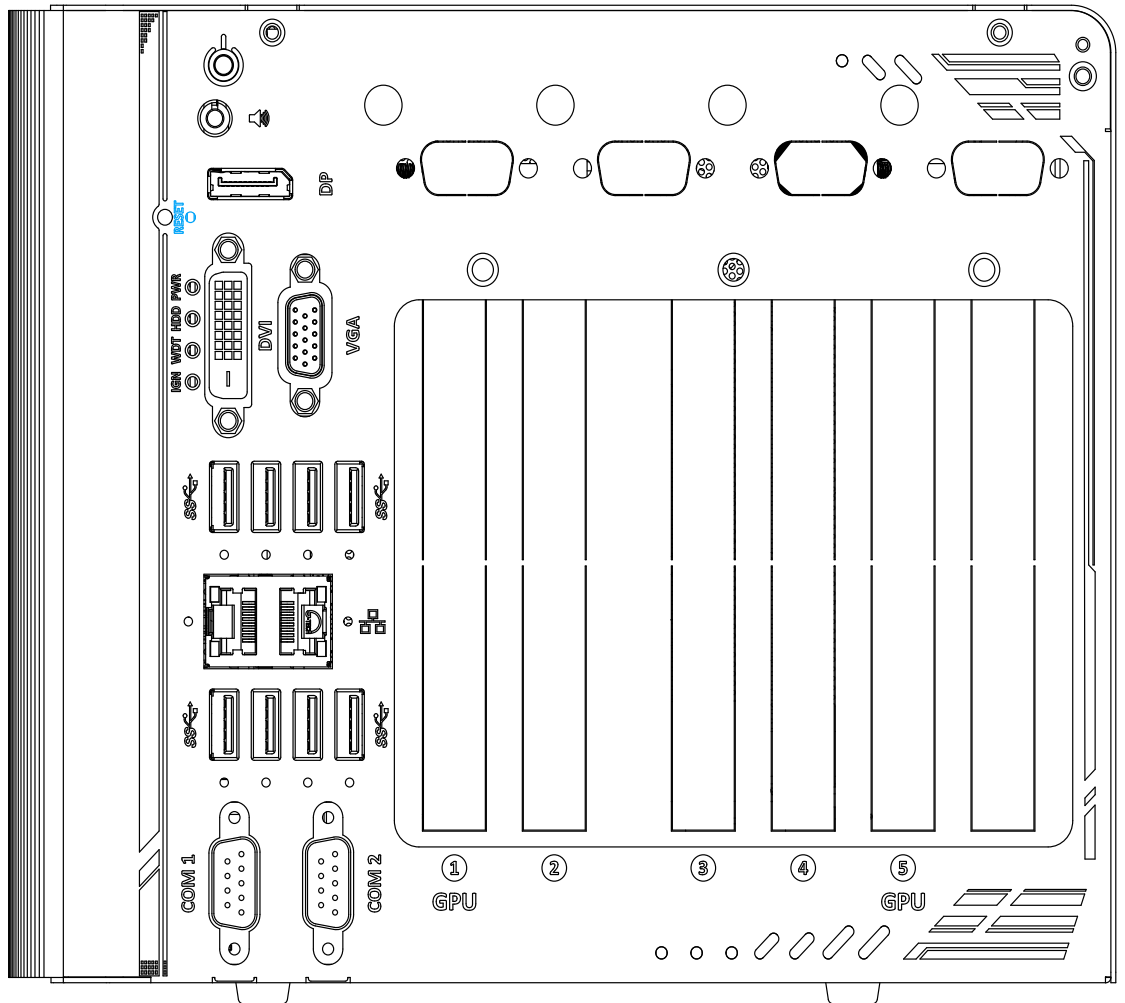

The reset button is used to manually reset the system in case of system halt or malfunction. To avoid unexpected reset, the button is purposely placed behind the panel. To reset, please use a pin-like object (eg. tip of a pen) to access the reset button

2.2.5 LED Indicators

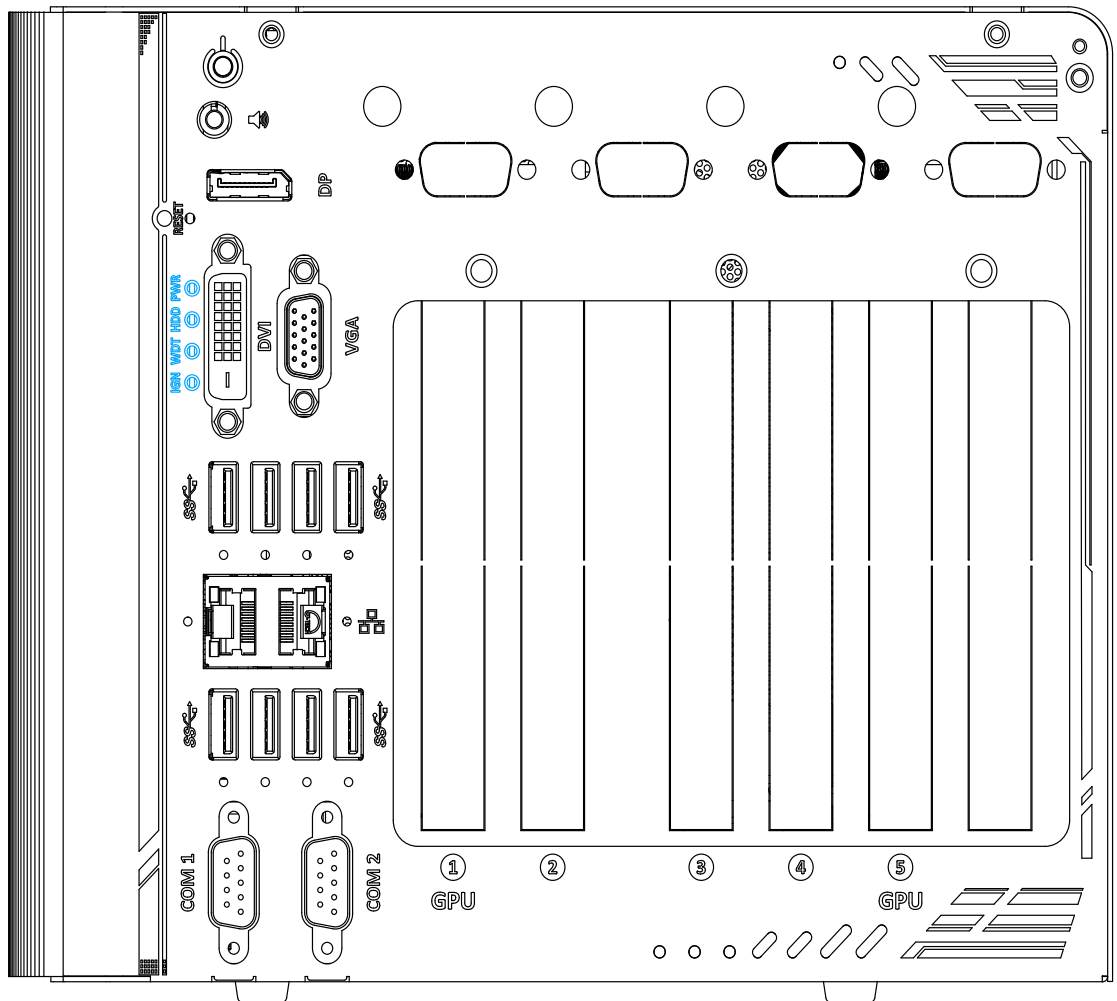

There are four LED indicators on the I/O panel: IGN, WDT, HDD and PWR. The descriptions of these four LED are listed in the following table.

Indicator	Color	Description
PWR	Green	Power indicator, lid when system is on.
HDD	Red	Hard drive indicator, flashing when hard disk drive is active.
WDT	Yellow	Watchdog timer LED, flashing when WDT is active.
IGN	Yellow	Ignition signal indicator, lid when IGN is high (12V/ 24V).

2.2.6 DVI Port

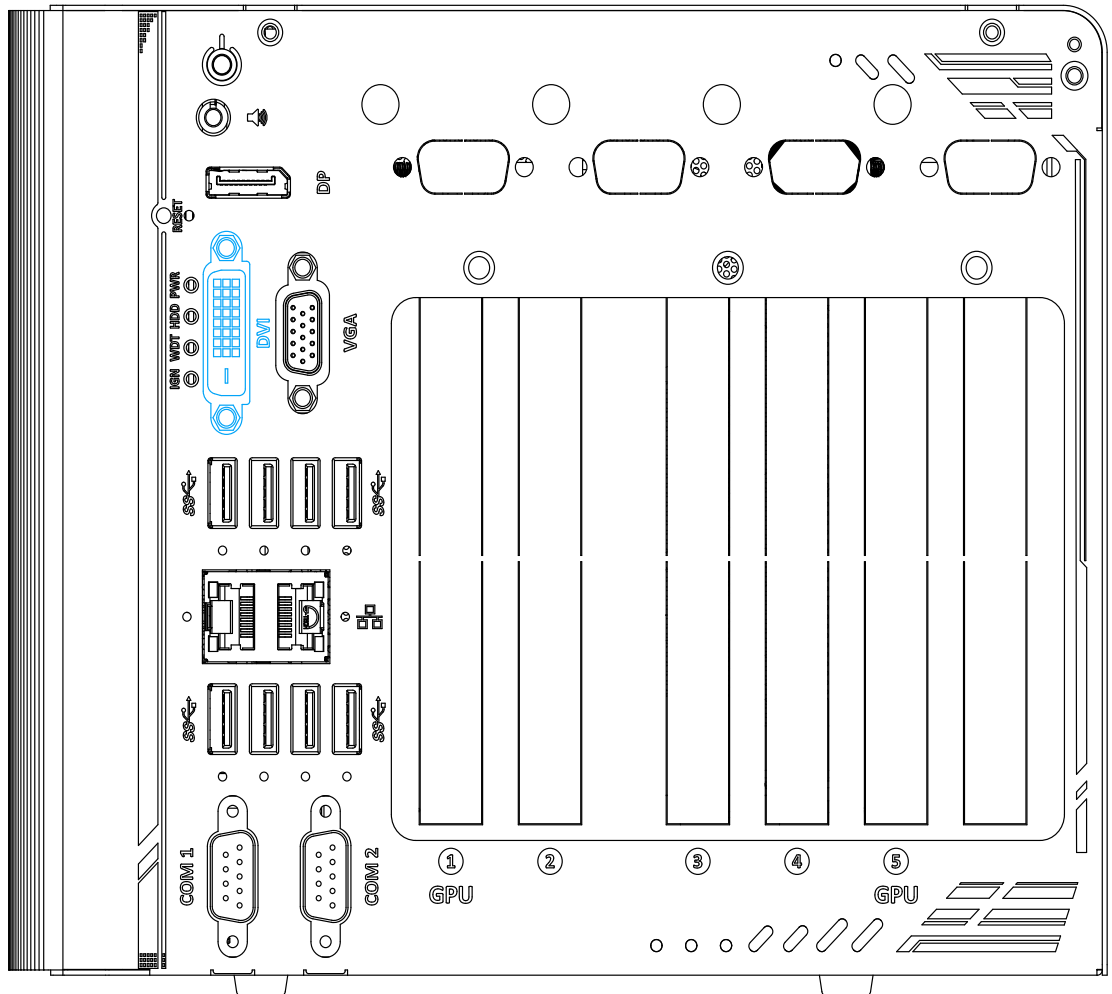

DVI-D transmits graphics data in digital format and therefore can deliver better image quality at high resolution. The DVI connector on the front panel can either output DVI signals or other digital signals (via an adapter/ cable) depending on the display device connected. It supports resolutions up to 1920x1200@60Hz.

The system supports triple independent display outputs by connecting display devices to VGA, DVI and DisplayPort. To support multiple display outputs and achieve best DVI output resolution in Windows, you need to install corresponding graphics driver. Please refer to section [OS Support and Driver Installation](#) for details.

2.2.7 VGA Port

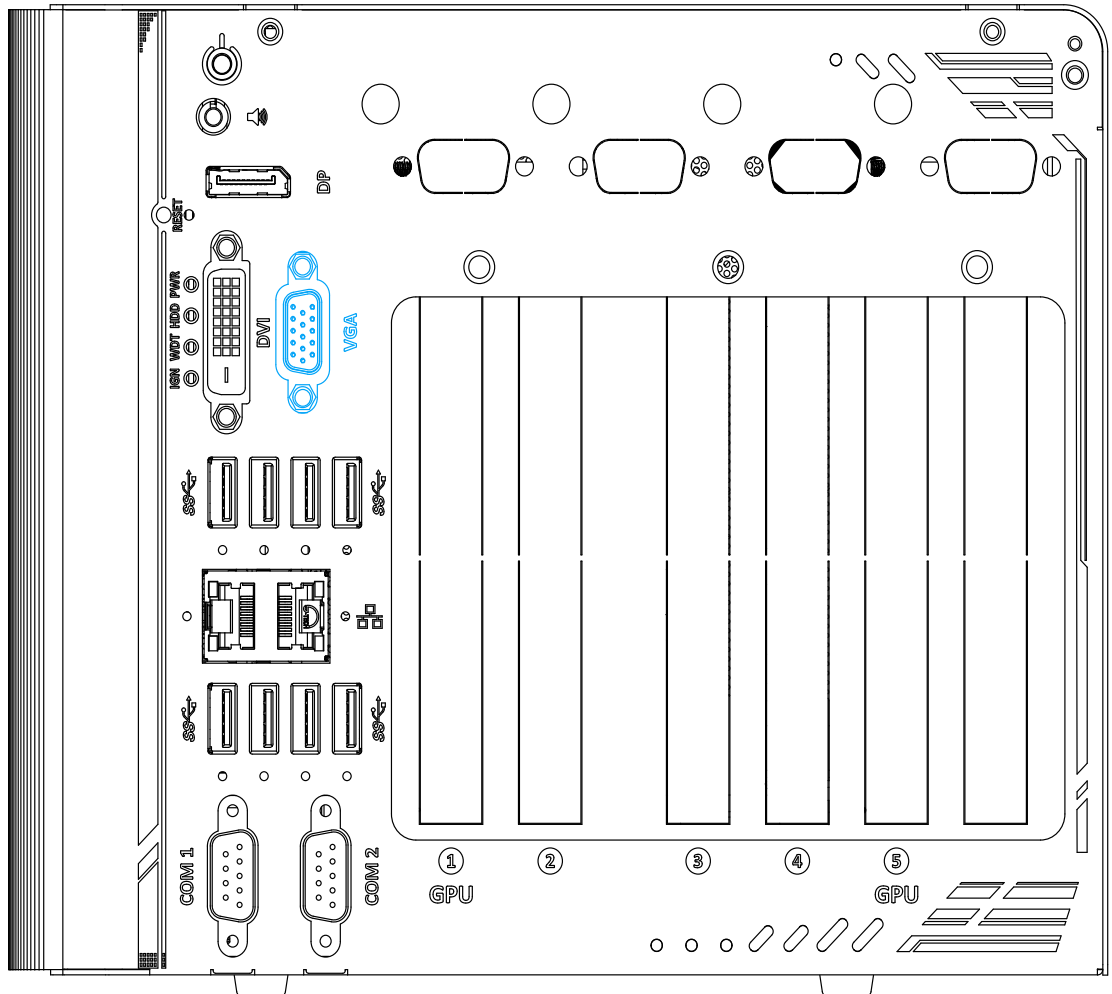

VGA connector is the most common video display connection. The VGA output supports up to 1920x1200@60Hz resolution.

The system supports triple independent display outputs by connecting display devices to VGA, DVI and DisplayPort. To support multiple display outputs and achieve best VGA output resolution in Windows, you need to install corresponding graphics drivers. Please refer to section [OS Support and Driver Installation](#) for details.



NOTE

Please make sure your VGA cable includes SDA and SCL (DDC clock and data) signals for correct communication with monitor to get resolution/timing information. A cable without SDA/ SCL can cause blank screen on your VGA monitor due to incorrect resolution/timing output.

2.2.8 USB3.1 Gen 2 Port

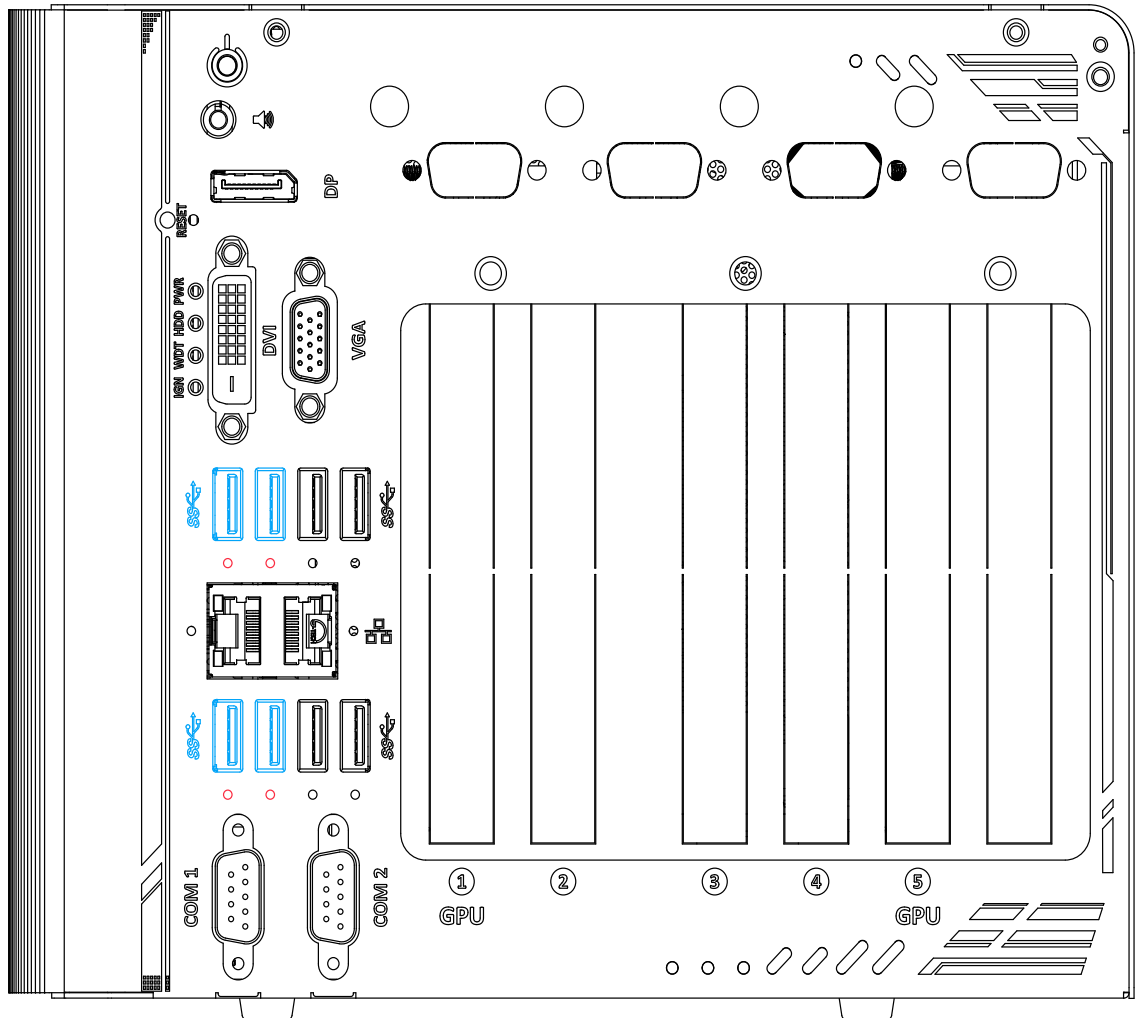

The system's USB 3.1 Gen 2 ports (10Gbps) are implemented via native xHCI (eXtensible Host Controller Interface) controller and are backward compatible with USB3.1 Gen.1 USB 2.0, USB 1.1 and USB 1.0 devices. Legacy USB is also supported so you can use USB keyboard/mouse in DOS environment. There are also screw-lock openings (indicated in red) for each USB port.

xHCI driver is supported natively in Windows 10, therefore you do not need to install xHCI driver in prior to utilize USB functions.

2.2.9 Gigabit Ethernet Port

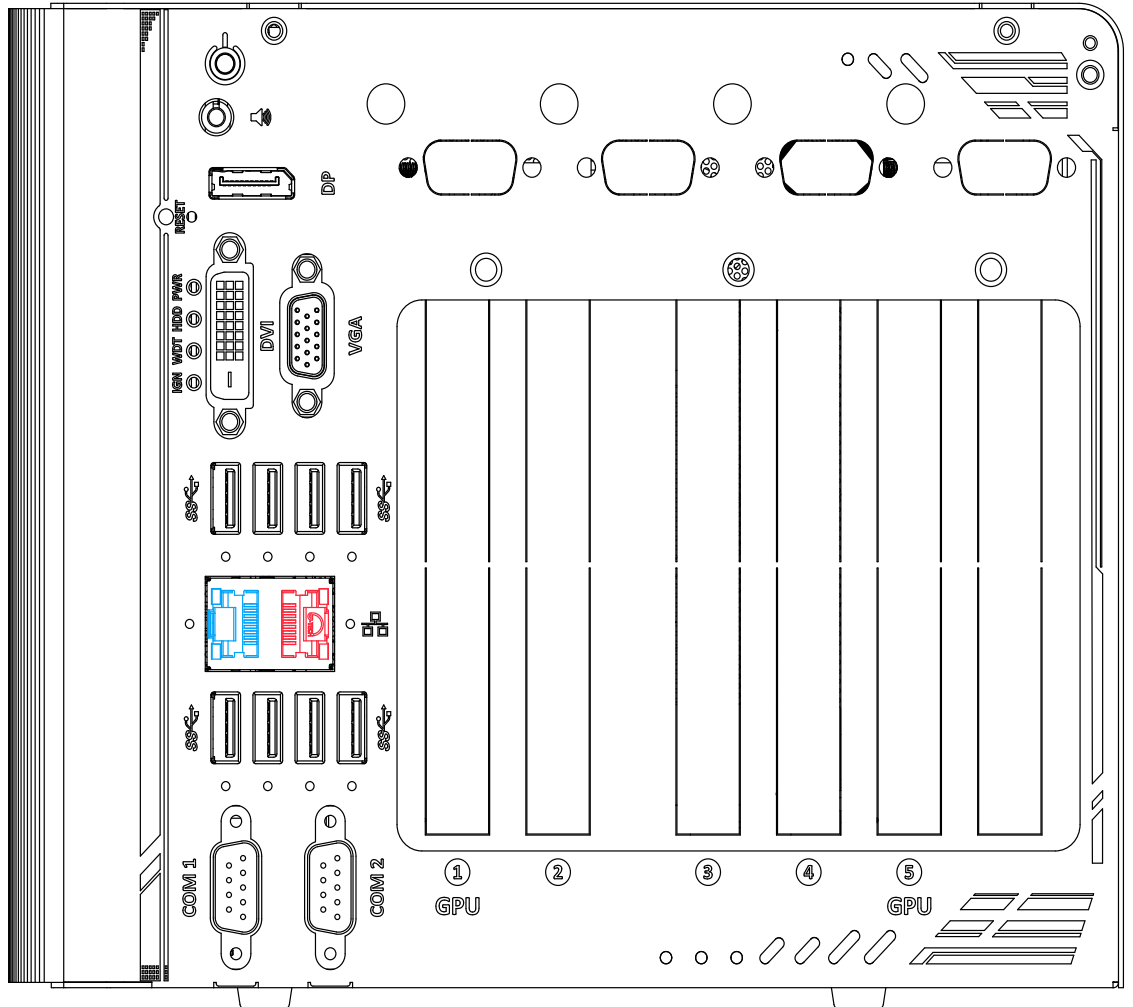

The system offers 2 GbE ports on its I/O panel. The GbE ports are marked in **blue/ red** and are implemented with Intel® I219-LM/ Intel® I210-IT controllers, respectively. Each port has one dedicated PCI Express link for maximum performance. When an Ethernet connection is established, the LED indicators on the RJ45 connector represents the following connection statuses:

Active/Link LED

LED Color	Status	Description
Green	Off	Ethernet port is disconnected
	On	Ethernet port is connected and no data transmission
	Flashing	Ethernet port is connected and data is transmitting/receiving

Speed LED

LED Color	Status	Description
Green or Orange	Off	10 Mbps
	Green	100 Mbps
	Orange	1000 Mbps

The port implemented using Intel® I219-LM (in **blue**) supports Wake-on-LAN function. Drivers may be required to utilize the GbE port in Windows environment.

2.2.10 USB3.1 Gen 1 Port

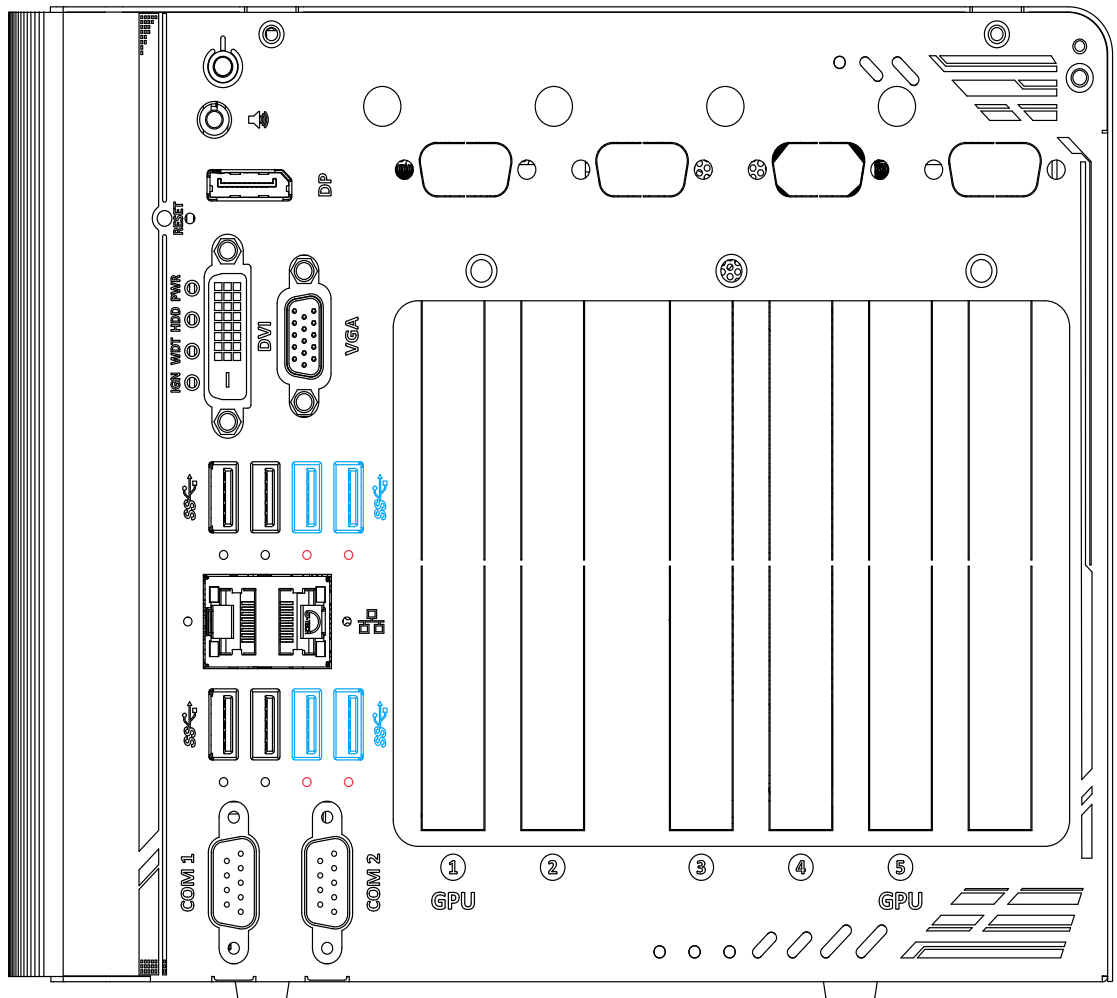

The system's USB 3.0 Gen 1 ports (5Gbps) are implemented via native xHCI (eXtensible Host Controller Interface) controller and are backward compatible with USB 2.0, USB 1.1 and USB 1.0 devices. Legacy USB is also supported so you can use USB keyboard/mouse in DOS environment. There are also screw-lock openings (indicated in **red**) for each USB port. xHCI driver is supported natively in Windows 10, therefore you do not need to install xHCI driver in prior to utilize USB functions.

2.2.11 COM Port

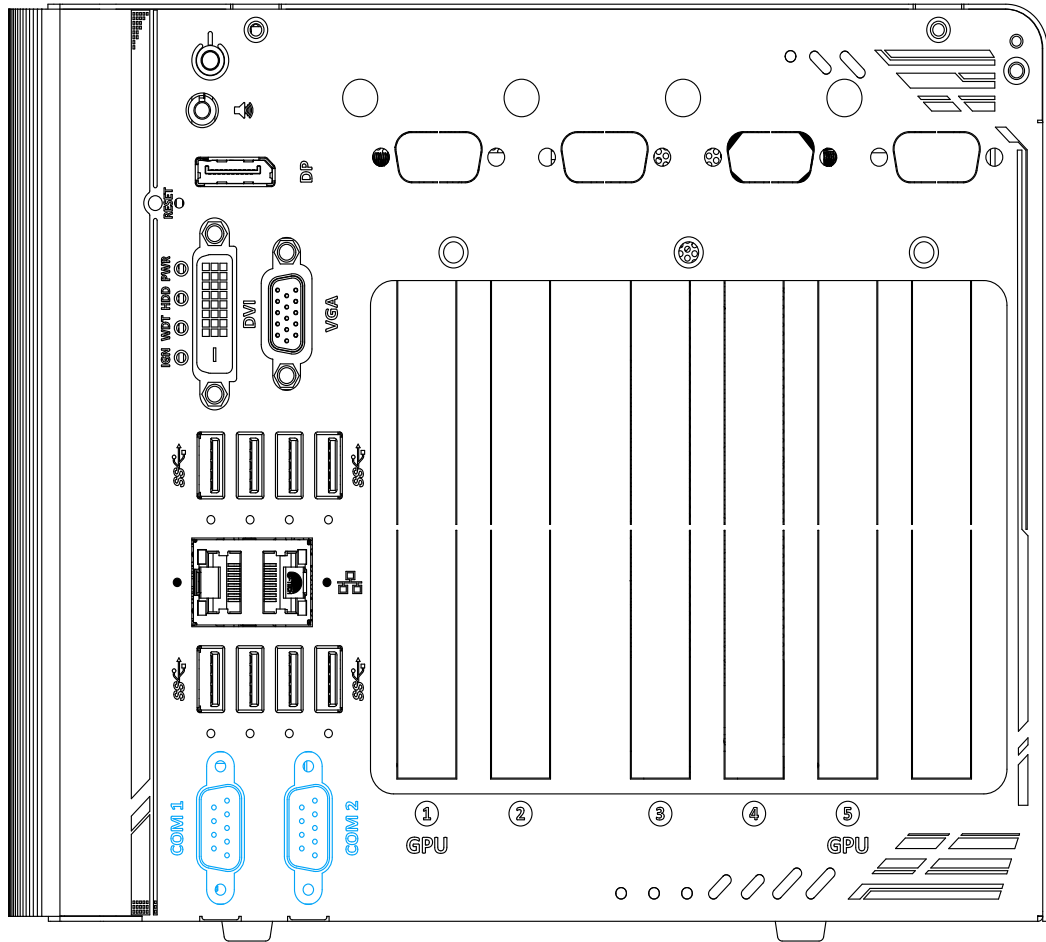

The two COM ports are implemented using industrial-grade ITE8786 Super IO chip (-40 to 85°C) and provide up to 115200 bps baud rate. COM1 and COM2 (in red) are software-configurable RS-232/422/485 ports. COM3 and COM4 (in blue) are standard 9-wire RS-232 ports. The operation mode of COM1 and COM2 can be set in BIOS setup utility. The following table describes the pin definition of COM ports.

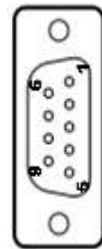

COM Port Pin Definition

Pin#	COM1 & COM2		
	RS-232 Mode	RS-422 Mode	RS-485 Mode
1	DCD		
2	RX	422 TXD+	485 TXD+/RXD+
3	TX	422 RXD+	
4	DTR	422 RXD-	
5	GND	GND	GND
6	DSR		
7	RTS		
8	CTS	422 TXD-	485 TXD-/RXD-
9	RI		

2.3 Ignition/ Dual 4-Pin Terminal Block

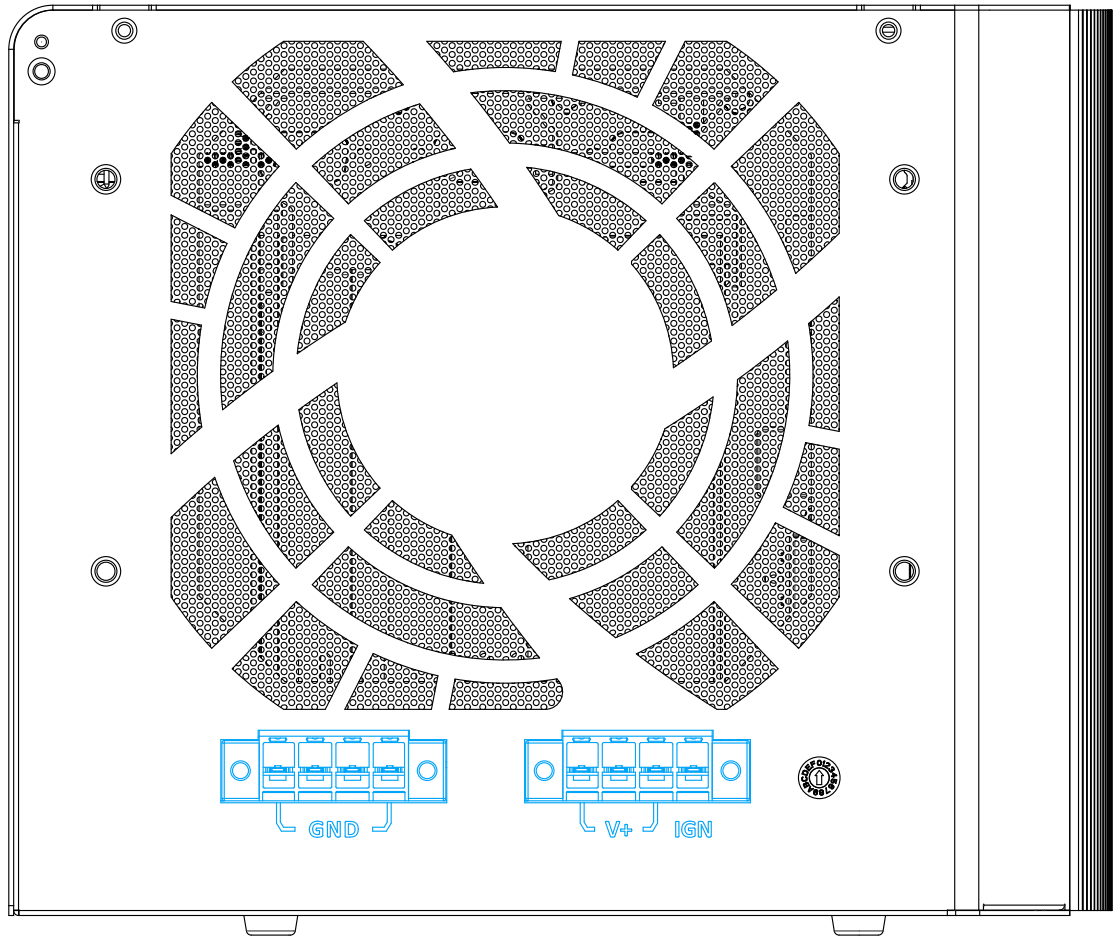

The system accepts a wide range of DC power input from 8 to 35V via dual 4-pin pluggable terminal block, which is fit for field usage where DC power is provided. The screw clamping mechanism on the terminal block offers connection reliability when wiring DC power. In addition to DC power input, this terminal block can also accept ignition signal input (IGN) for in-vehicle applications.

WARNING

*Please make sure the voltage of DC power is correct before you connect it to the system.
Supplying a voltage over 35V will damage the system.*

2.4 Ignition Control Switch

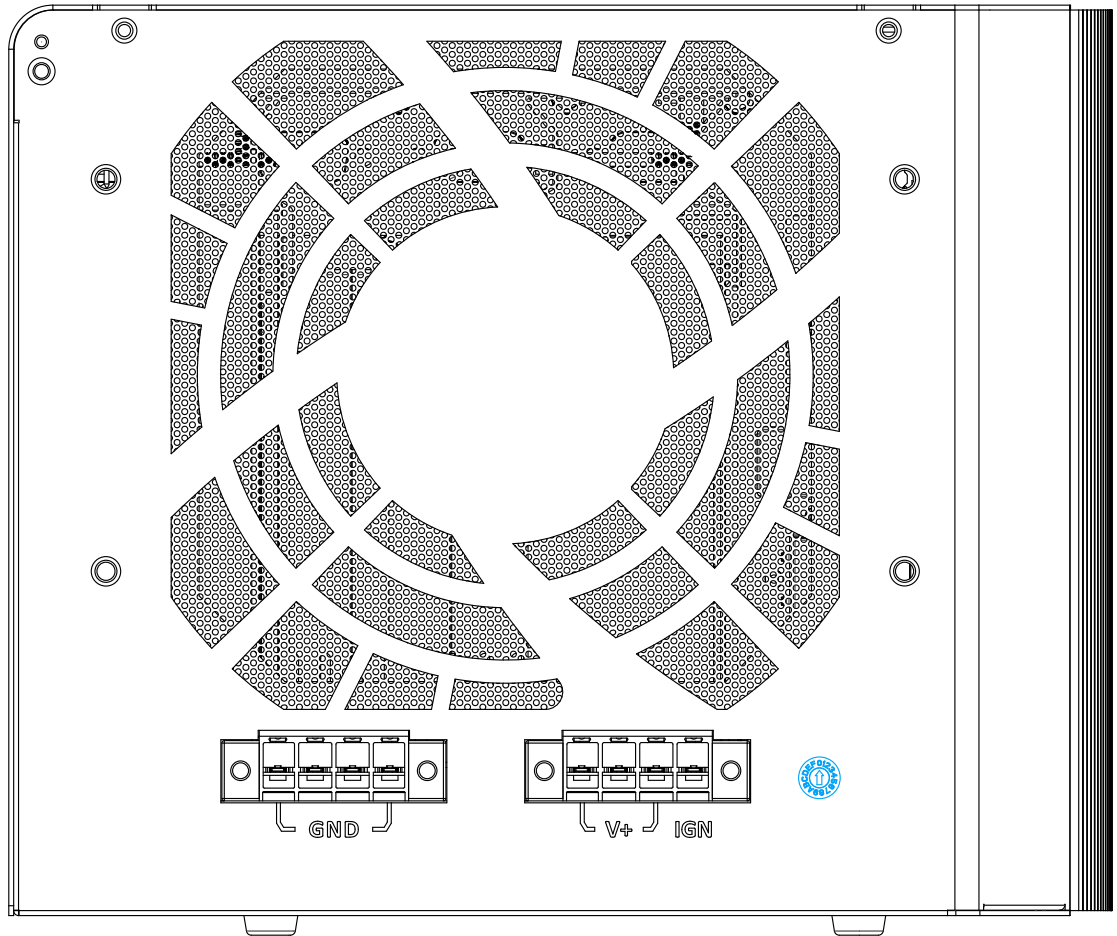

The ignition power control switch features multiple modes for pre and post ignition settings. Please refer to the section Ignition Power Control for details. Please use a flathead screwdriver to adjust the position of the ignition power control switch.

For details, please refer to the section [Ignition Power Control](#) for details

2.5 Internal I/O Functions

In addition to I/O connectors on the front panel, the system also provides internal on-board connectors, such as remote on/off control, LED status output, internal USB 2.0 ports, etc. In this section, we'll illustrate these internal I/O functions.

2.5.1 SODIMM DRAM Slot

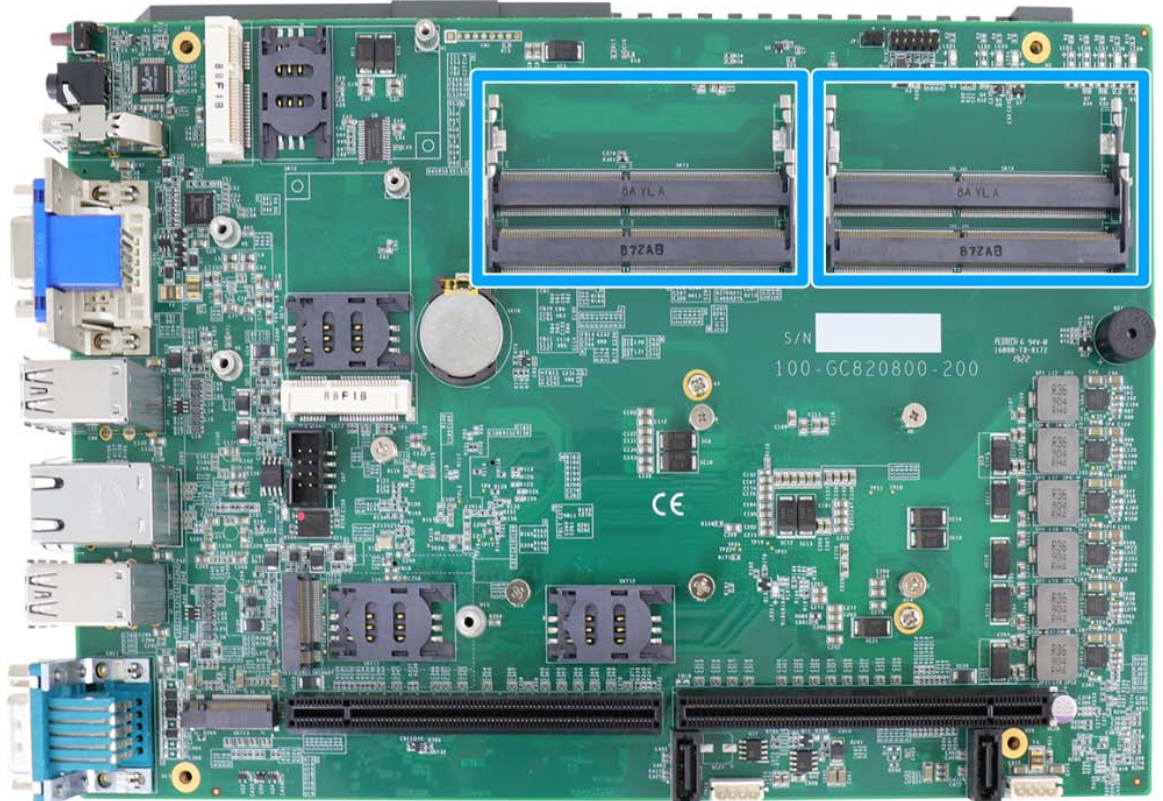

The system motherboard supports four 260-pin SODIMM socket for installing DDR4 memory module up to 128GB. Each slot supports single module DDR4 2133MHz SODIMM up to 32GB capacity.



NOTE

When changes are made to DRAM module(s), such as additionally install or remove and reinstall (into the same/ different slot, it will result in an approximately 30~60 seconds delay when booting up for the first time after such change(s).

2.5.2 Dual Mode mSATA/ mini-PCle Socket & Pin Definition

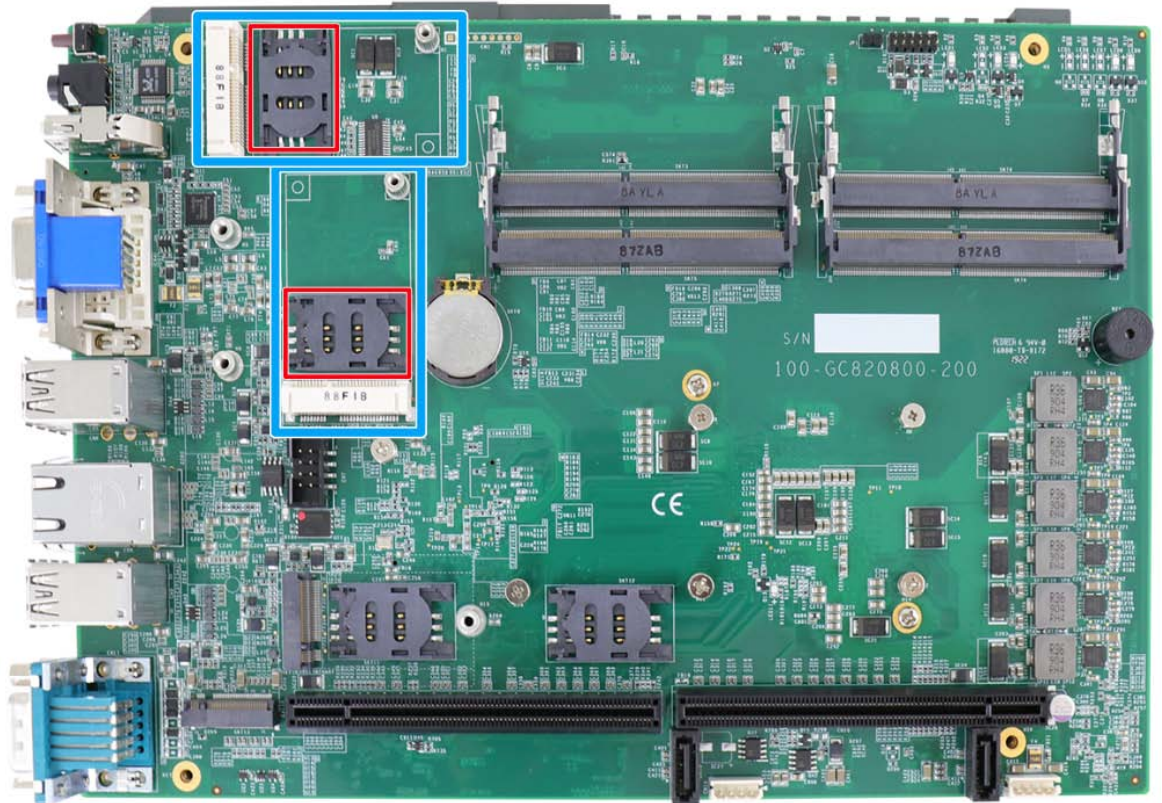

The system provides a dual mode mSATA/ mini-PCle socket (indicated in **blue**) that is in compliance with mini-PCle specification rev. 1.2. You can install either an mSATA SSD or mini-PCle module into this socket and the system will automatically detect and configure it to run PCIe or SATA signals. This mini-PCle socket is designed with SIM card (slot indicated in **red**) support. With a SIM card installed, your system can access the internet via your network provider's 3G/ 4G network.

For wireless (WIFI/ 3G/ 4G) communication, multiple SMA antenna apertures (indicated in **blue**) can be located on the front and rear panel.

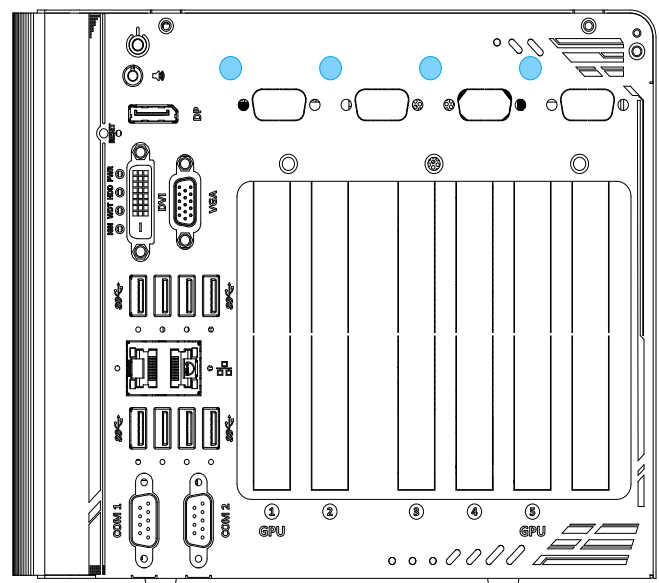

Dual mode mSATA/ mini-PCle socket definition

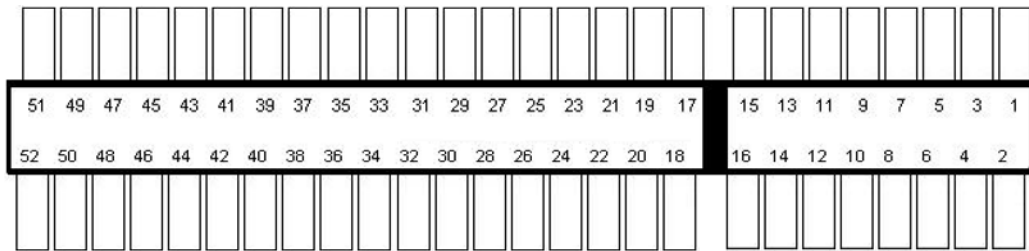

Pin	Signal (mPCle)	Signal (mSATA)	Pin #	Signal (mPCle)	Signal (mSATA)
1	WAKE#	-	2	+3.3Vaux	3.3V
3	-	-	4	GND	GND
5	-	-	6	+1.5V	+1.5V
7	CLKREQ#	-	8	UIM_PWR	-
9	GND	GND	10	UIM_DATA	-
11	REFCLK-	-	12	UIM_CLK	-
13	REFCLK+	-	14	UIM_RESET	-
15	GND	GND	16	UIM_VPP	-
Mechanical Key					
17	Reserved*	-	18	GND	GND
19	Reserved*	-	20	W_DISABLE#	-
21	GND	GND	22	PERST#	-
23	PERn0	SATA_Rxp	24	3.3V	3.3V
25	PERp0	SATA_Rxn	26	GND	GND
27	GND	GND	28	+1.5V	+1.5V
29	GND	GND	30	SMB_CLK	SMB_CLK
31	PETn0	SATA_Txn	32	SMB_DATA	SMB_DATA
33	PETp0	SATA_Txp	34	GND	GND
35	GND	GND	36	USB_D-	-
37	GND	GND	38	USB_D+	-
39	3.3V	3.3V	40	GND	GND
41	3.3V	3.3V	42	-	-
43	GND	-	44	-	-
45	Reserved	-	46	-	-
47	Reserved	-	48	+1.5V	+1.5V
49	Reserved	-	50	GND	GND
51	Reserved	-	52	3.3V	3.3V

 **WARNING**

Some off-the-shelf mini-PCle 4G modules are not compliant to standard mini-PCle interface. They use 1.8V I/O signals instead of standard 3.3V I/O and may have signal conflict. Please consult with Neosys for compatibility when in doubt!

Installing an incompatible 4G module may damage the system or the module itself may be damaged.

2.5.3 M.2 2242 (B Key), Dual-SIM Card Slot & Pin Definition



The dual SIM card functionality is only available when Sierra Wireless EM7455/ 7430 solution is installed. For other 4G add-on solutions, SIM card slot 1 is the default functioning slot.

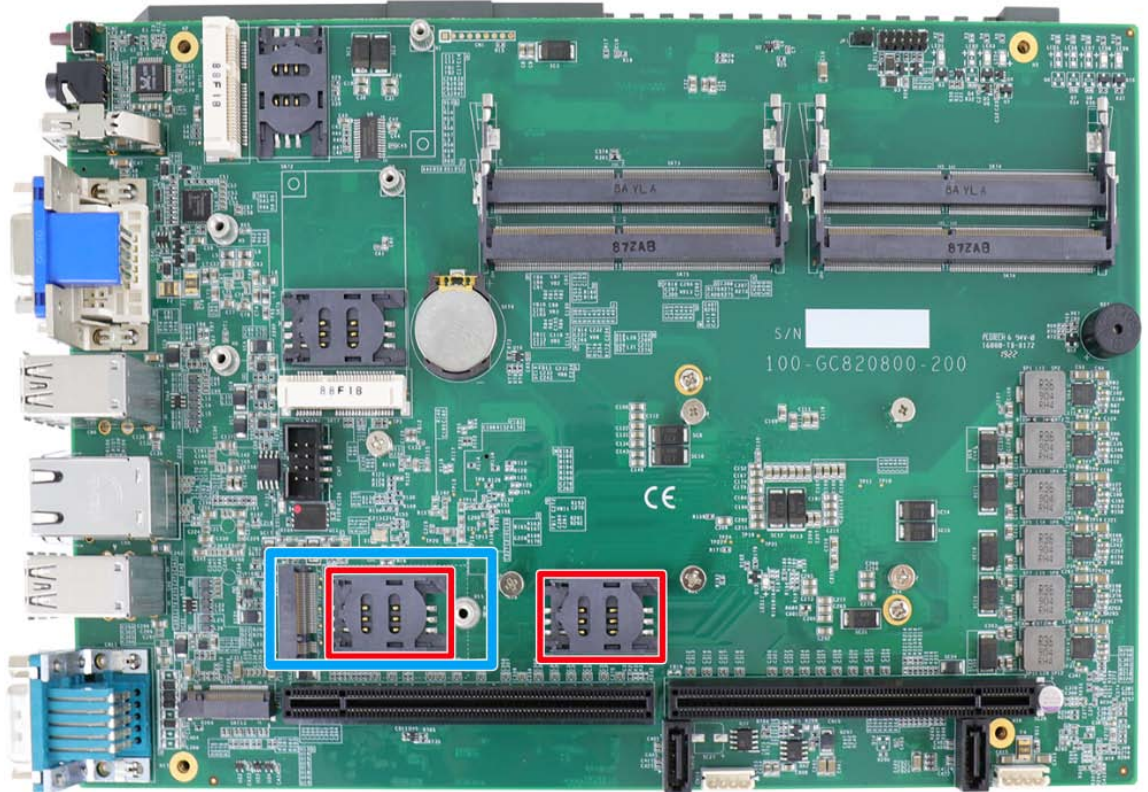

The system has an M.2 2242 slot (indicated in **blue**) that works with dual SIM slots (4G + 3G) indicated in **red**. By installing a 3G or 4G M.2 module and SIM card, you can access the internet via the provider's network.

For wireless 3G/ 4G, multiple SMA antenna apertures (indicated in **blue**) can be located on the front and rear panel.

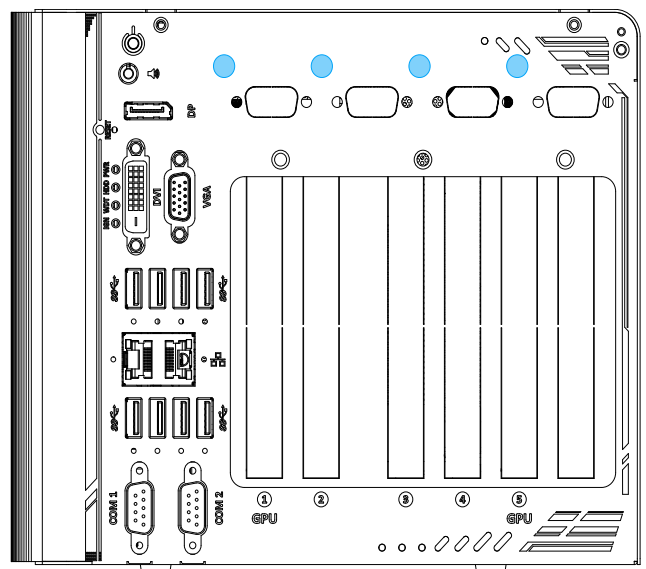

M.2 (B Key) Slot Pin Definition

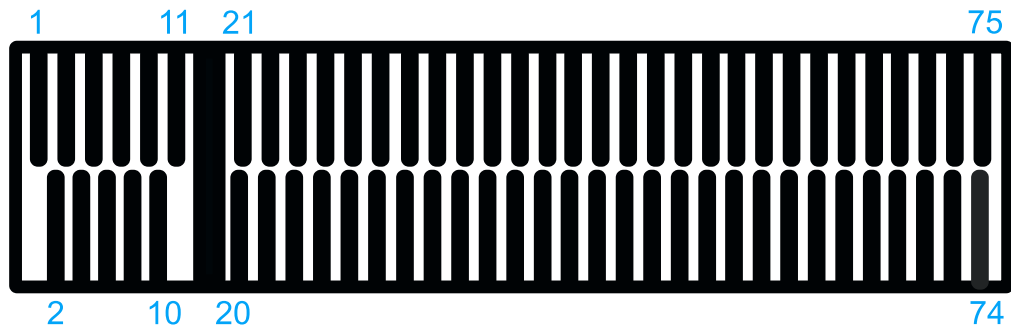

Pin #	Signal	Pin #	Signal
1	-	2	+3V3
3	GND	4	+3V3
5	GND	6	FULL_CARD_POWER_OFF_N
7	USB_D+	8	W_DISABLE_N
9	USB_D-	10	-
11	GND		
Mechanical Key			
21	-	20	-
23	-	22	-
25	-	24	-
27	GND	26	-
29	USB3.0-RX-	28	-
31	USB3.0-RX+	30	UIM1-RESET
33	GND	32	UIM1-CLK
35	USB3.0-TX-	34	UIM1-DATA
37	USB3.0-TX+	36	UIM1-PWR
39	GND	38	-
41	PERn0 / SATA-B+	40	UIM2-DET
43	PERp0 / SATA-B-	42	UIM2-DATA
45	GND	44	UIM2-CLK
47	PETn0 / SATA-A-	46	UIM2-RST
49	PETp0 / SATA-A+	48	UIM2-PWR
51	GND	50	PERST_N
53	REFCLKN	52	-
55	REFCLKP	54	-
57	GND	56	-
59	-	58	-
61	-	60	-
63	-	62	-
65	-	64	-
67	RESET_N	66	UIM1_DETECT
69	CONFIG_1	68	-
71	GND	70	+3V3
73	GND	72	+3V3
75	-	74	+3V3

2.5.4 SATA Ports

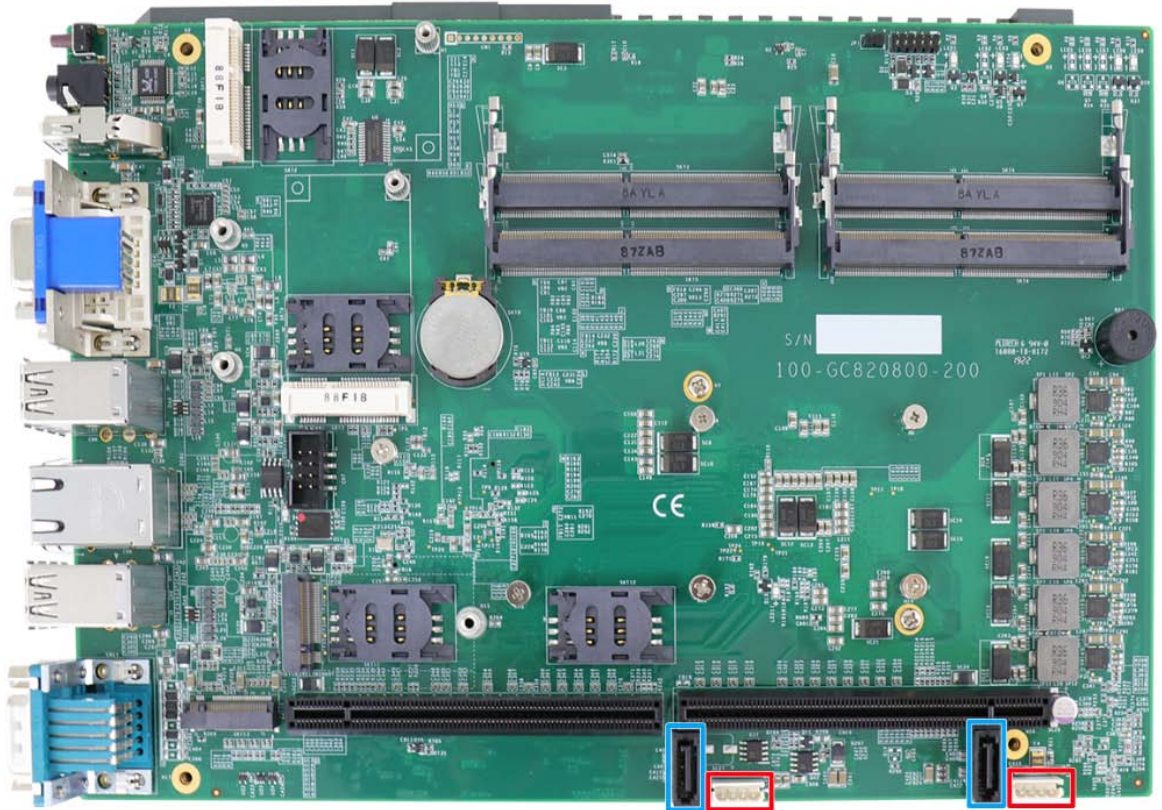

The system provides two SATA ports which support Gen3, 6 Gb/s SATA signals. Each SATA port (indicated in **blue**) features a 7-pin SATA connector and a 4-pin power connector.

The power connector (indicated in **red**) each accommodates a 2.5" HDD/ SSD in internal HDD bracket. Standard 22-pin SATA connectors are provided with the system. You may refer to the SATA Configuration section for SATA settings.

2.5.5 Status LED Output & Remote On/ Off Control and Pin Definition

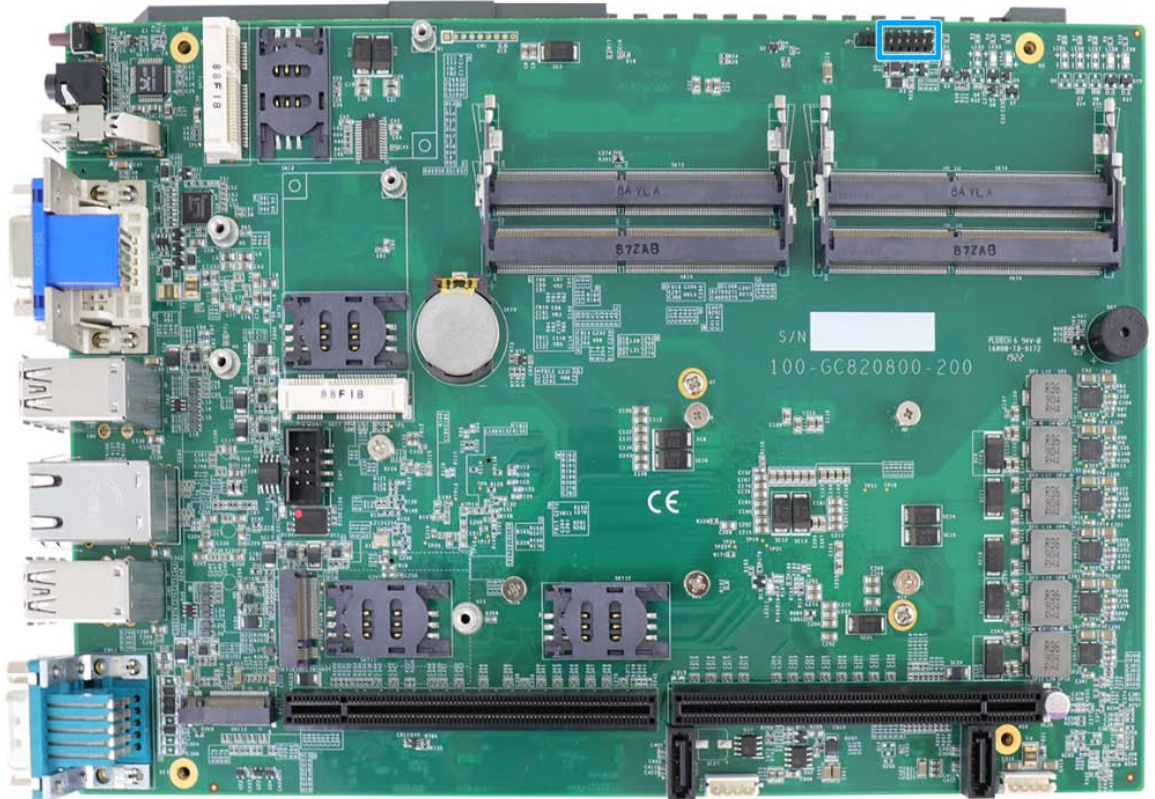

Pin#	Definition	Description
1	WDT_LED-	[Output] Watchdog timer indicator, flashing when Watchdog timer is active
2	WDT_LED+	
3	Standby Power-	[Output] Standby power indicator, on if DC power is applied and system is in S5 (standby) mode.
4	Standby Power+	
5	HDD-	[Output] Hard drive indicator, flashing when SATA hard drive is active.
6	HDD+	
7	Power-	[Output] System power indicator, on if system is turned on, off if system is turned off.
8	Power+	
9	Ctrl-	[Input] Remote on/off control, connects to an external switch to turn on/off the system (polarity is negligible).
10	Ctrl+	
11	IGN_LED-	[Output] Ignition control indicator, on if ignition control is on, off if ignition control is off.
12	IGN_LED+	

2.5.6 Internal USB Port on Extension Board



The system's daughter board has an internal USB2.0 port on the PCBA. You can utilize this USB port to connect a USB protection dongle inside the chassis of the system.

2.5.7 M.2 2280 (M Key) Slot for NVMe SSD or Optane™ Memory

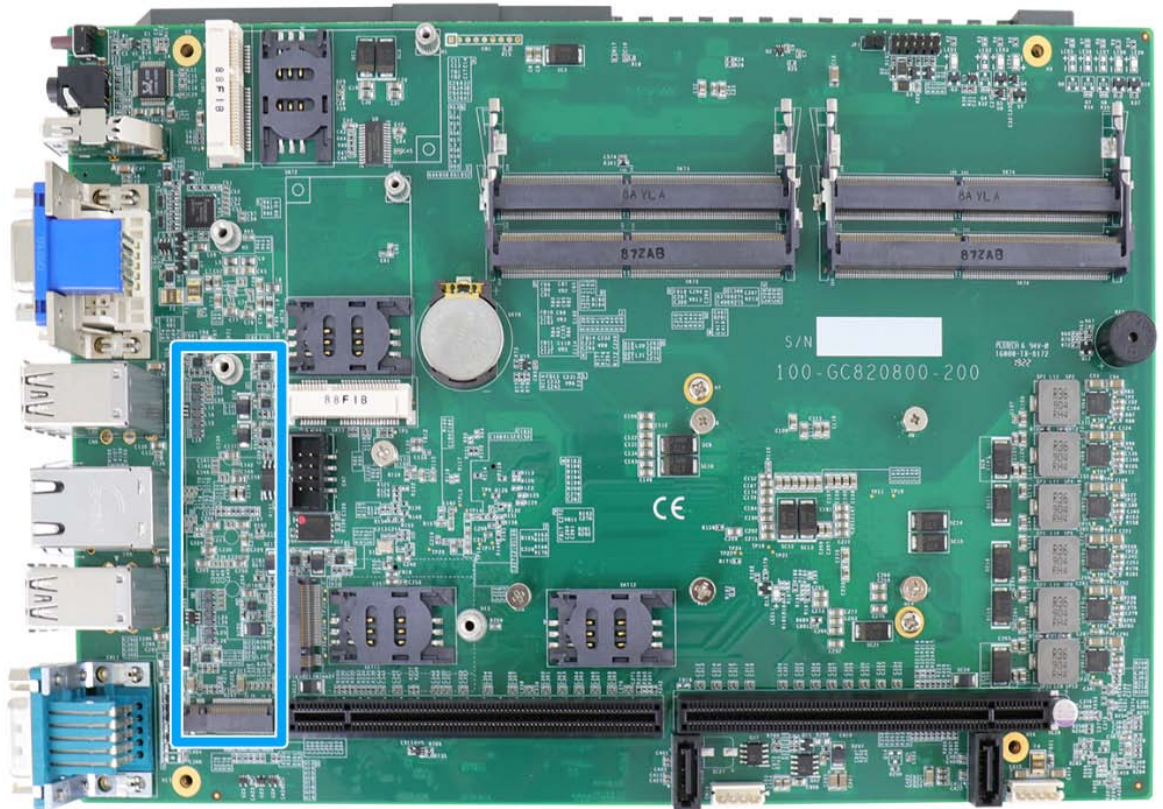

The system has an x4 PCIe M.2 2280 slot (also in compliance with SATA signal) for you to install an NVMe SSD for the ultimate performance or an Intel® Optane™ memory to accelerate the read/ write performances of traditional hard disk drive. An NVMe SSD offers exceptional performance over 2.5" SSDs while Intel® Optane™ memory can dramatically boost your traditional hard disk drives' read/ write performances.



NOTE

The M.2 slot will automatically detect and configure the slot to run PCIe or SATA signal depending on the installed device.

M.2 (M Key) Slot Pin Definition

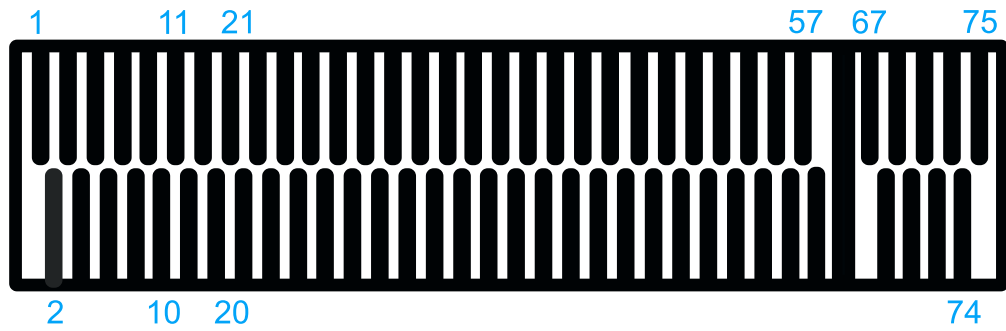

Pin #	Signal	Pin #	Signal
1	GND	2	+3V3
3	GND	4	+3V3
5	PERN3	6	-
7	PERP3	8	-
9	GND	10	DAS/DSS_N
11	PETN3	12	+3V3
13	PETP3	14	+3V3
15	GND	16	+3V3
17	PERN2	18	+3V3
19	PERP2	20	-
21	GND	22	-
23	PETN2	24	-
25	PETP2	26	-
27	GND	28	-
29	PERN1	30	-
31	PERP1	32	-
33	GND	34	-
35	PETN1	36	-
37	PETP1	38	-
39	GND	40	-
41	PERn0 / SATA-B+	42	-
43	PERp0 / SATA-B-	44	-
45	GND	46	-
47	PETn0 / SATA-A-	48	-
49	PETp0 / SATA-A+	50	PERST_N
51	GND	52	-
53	REFCLKN	54	-
55	REFCLKP	56	-
57	GND	58	-
Mechanical Key			
67	-	68	SUSCLK
69	PEDET	70	+3V3
71	GND	72	+3V3
73	GND	74	+3V3
75	GND		

3 System Installation

Before disassembling the system enclosure and installing components and modules, please make sure you have done the following:

- It is recommended that only qualified service personnel should install and service this product to avoid injury or damage to the system.
- Please observe all ESD procedures at all times to avoid damaging the equipment.
- Before disassembling your system, please make sure the system has powered off, all cables and antennae (power, video, data, etc.) are disconnected.
- Place the system on a flat and sturdy surface (remove from mounts or out of server cabinets) before proceeding with the installation/ replacement procedure.

3.1 Disassembling the System

To access system internal components, the system needs to be disassembled. To disassemble the system enclosure, you need to remove the Cassette module and screws on both I/O panels.

1. One the I/O panel, remove two screws indicated.



2. Remove six screws indicated on the side panel.



3. Remove two screws indicated on the top.



4. On the rear exhaust fan panel, remove two screws indicated in **blue**, and remove four screws indicated in **red** holding the exhaust fan in place.

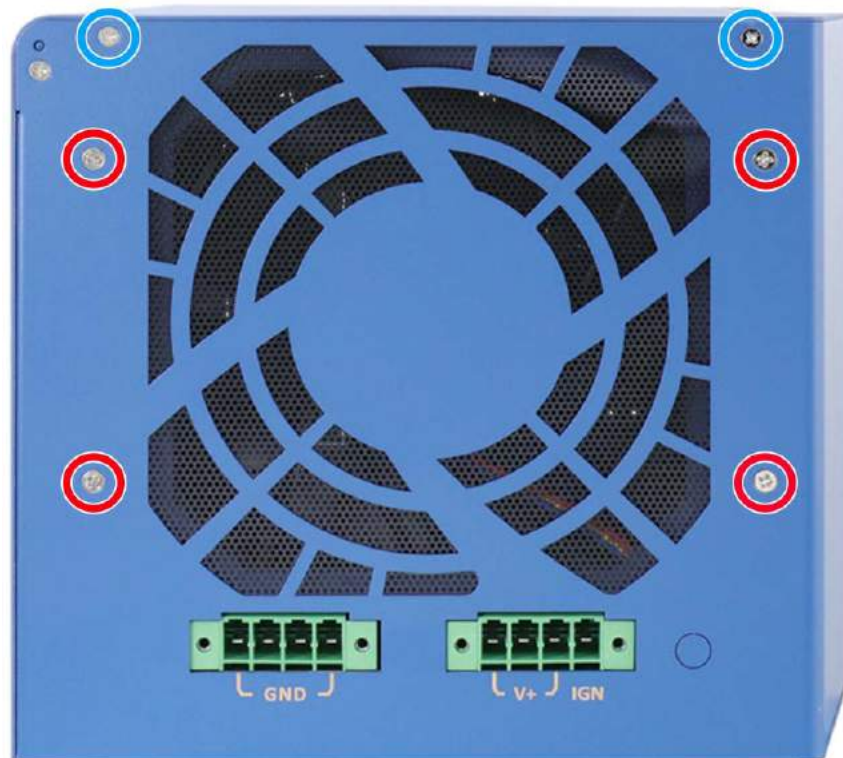

5. Gently lift the L-shape cover panel to separate it from the enclosure.



6. With the L-shape panel removed, remove the screws indicated to gain access to internal IO connectors.



7. If you did not purchase CPU/ RAM/ graphics card(s) with the system, please skip steps 8/ 9/ 10 and go to step 11.
8. If you would like to gain access to the installed CPU, the daughter board and exhaust fan need to be removed to gain access to the main motherboard and heatsink. Please continue with the steps below.
9. Gently wiggle off the exhaust fan as the rubber stands may become stuck to the vent and disconnect the fan's 4-pin plug.



10. Looking from the top, remove screws indicated and disengage the daughter-board from the motherboard.



Remove screws securing the daughter-board



Disengage the daughter-board from the motherboard

 **WARNING**

Please disengage the daughter-board gradually as there are capacitors situated underneath the PCIe slots that may come in contact with enclosure structures when removed with excessive force.

11. Remove screws indicated to separate the heatsink and motherboard from the enclosure.

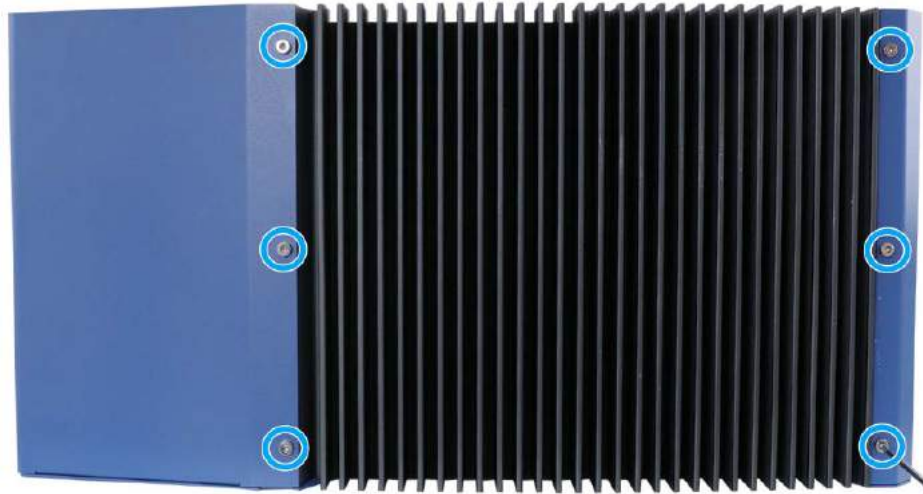

12. Remove the screws indicated to separate the motherboard from the heatsink.

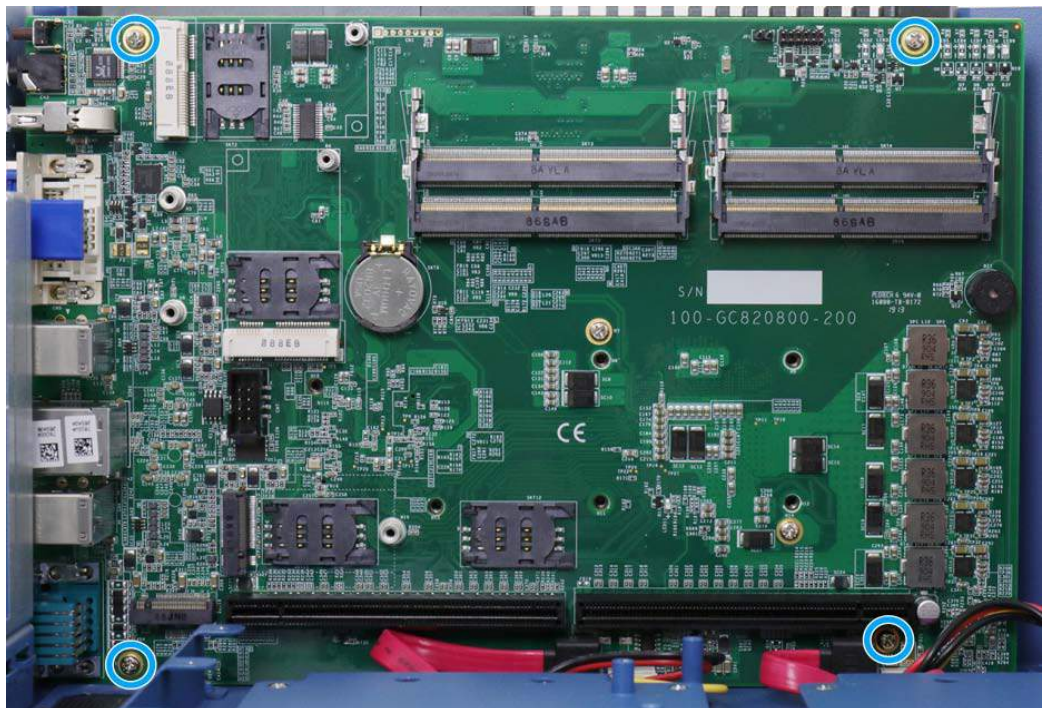

13. If your system has these six screws secured, please remove them as well before separating the motherboard from the heatsink.

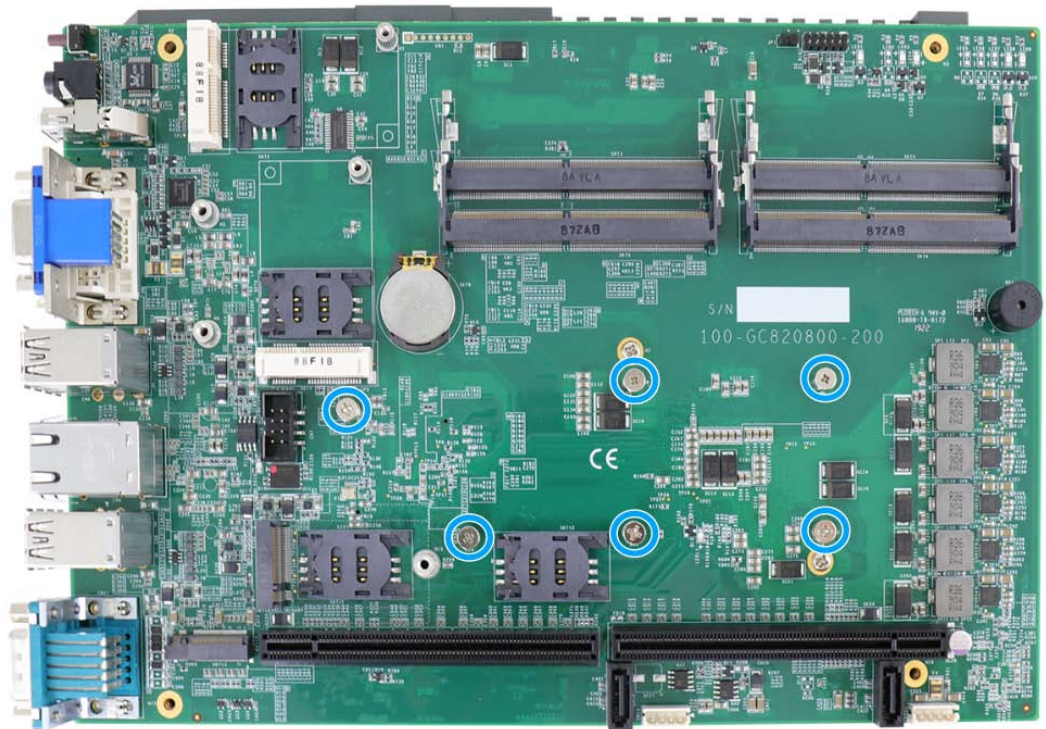

3.2 Installing Internal Components

3.2.1 CPU Installation Procedure

1. To install the CPU, you will need to separate the heatsink and the motherboard, please refer to [Disassembling the System](#).
2. If you are installing the CPU for the first time, you'll see the CPU socket protective cover, place finger tips underneath the sign "REMOVE" for leverage and gently lift the cover.



WARNING

*With the protective cover removed, please be careful when handling the motherboard.
DO NOT touch the pins in the LGA socket!*

3. Remove the CPU from its container/ tray. Match the two notches on the side to the protrusions in the socket, gently lower the CPU into the socket.



4. Locate the CPU retention bracket from the accessory box. Place the retention bracket on the CPU and hold it in place.



5. Turn the motherboard around and secure the bracket by tightening two M3 P-head screws.



6. Remove all thermal pads' protective films on the heatsink.

- With the four motherboard standoffs aligned, gently lower the motherboard onto the heatsink and secure the four screws. If you need to install other components, please refer to respective sections.

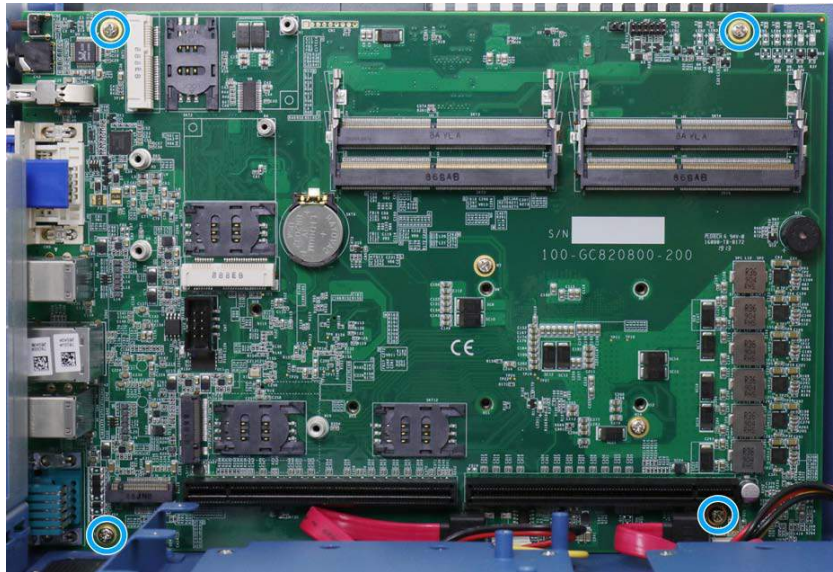

- Once the motherboard has been installed, you're ready to secure the screws that help the heatsink apply pressure to the CPU/ chipset die. You'll want to apply even pressure to the corners by gradually tightening each screw. Please refer to the recommended order when tightening the screws.

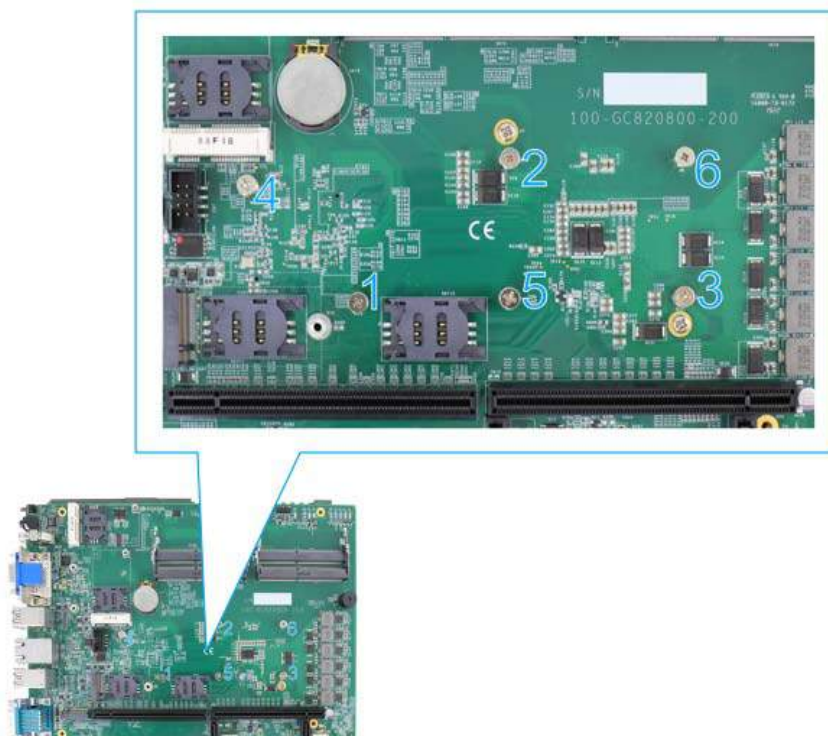

- To install other components, please refer to respective sections.

3.2.2 DDR4 SO-DIMM Installation

There are four SO-DIMM memory slots (indicated in **blue**) on the motherboard that supports a total maximum of 128GB ECC/ non-ECC DDR4-2666. Please follow the procedures below to replace or install the memory modules.

1. Please refer to the section “[Disassembling the System](#)”.
2. Locate the SODIMM memory module slots on the motherboard.

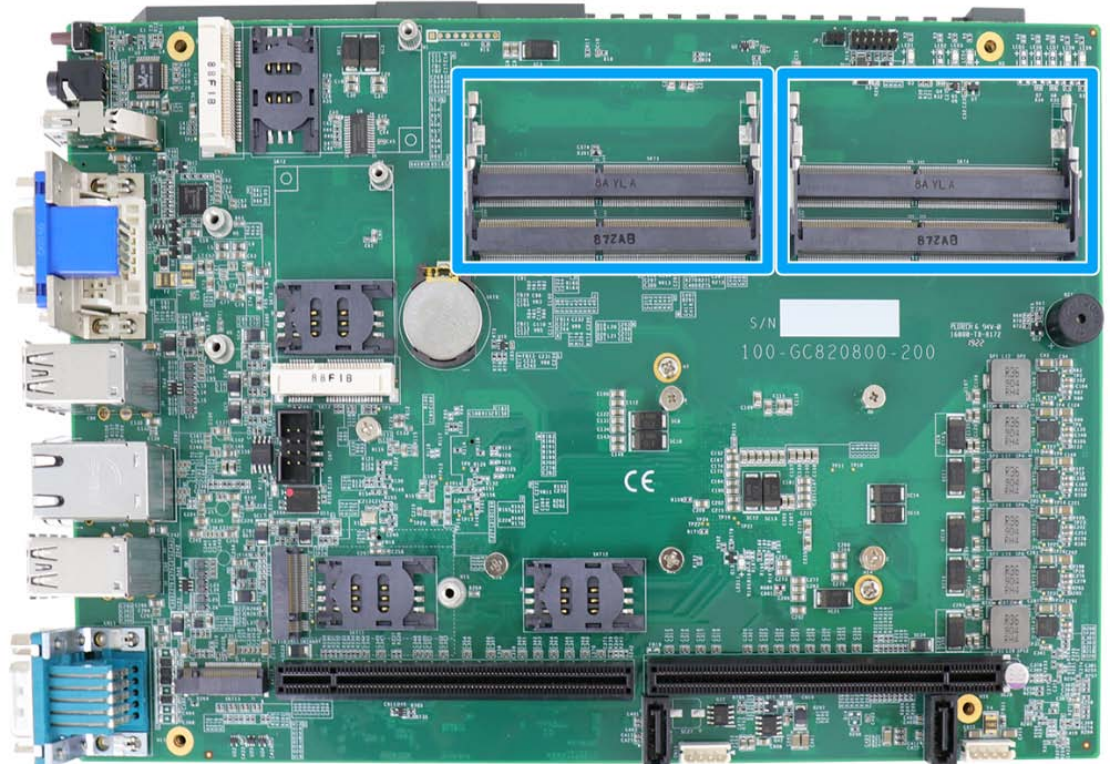

3. To install the memory module, insert gold fingers into the slot at 45-degree angle, push down on the memory module to clip the module into position.



4. Push the memory module down until it is clipped-in.



5. Repeat steps 3 and 4 to install the other module.
6. [Reinstall the system enclosure](#) and panel when done.
7. If you need to install other components, please refer to respective sections.

3.2.3 mPCIe Module, Mini-SIM (2FF) Card and Antennae Installation

The system has two mPCIe slots (indicated in **blue**) coupled with Mini-SIM socket (indicated in **red**) for installing 3G/ 4G module. For installation, please refer to the following instructions.

1. Please refer to the section "[Disassembling the System](#)".
2. Locate the mPCIe and Mini-SIM card slots on the motherboard.

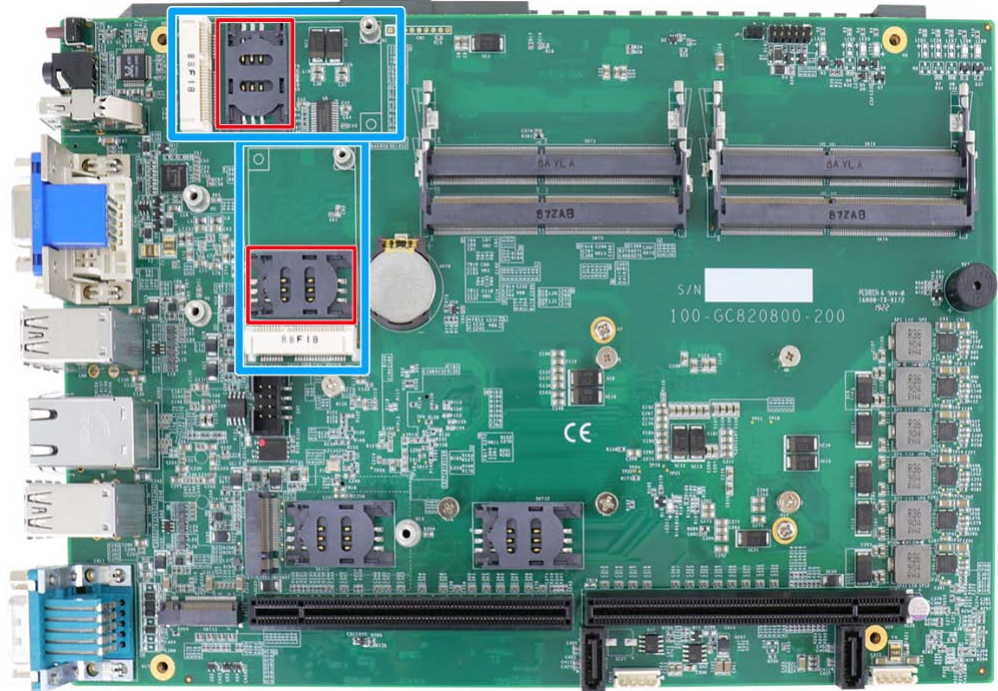

3. Before installing the mPCIe module, you need to insert the Mini-SIM card. Slide the Mini-SIM slot holder and lift the holder. Insert the Mini-SIM card (pins facing up), shut the Mini-SIM holder and slide it to lock the SIM card in-place.

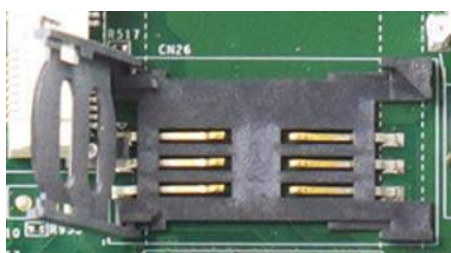

Slide and lift SIM card holder



Insert Mini-SIM card with pins facing up

4. Secure the Mini-SIM card by sliding the holder.



5. Insert the mPCIe module on a 45 degree angle into the mPCIe slot and secure the module.



Insert on 45 degree angle

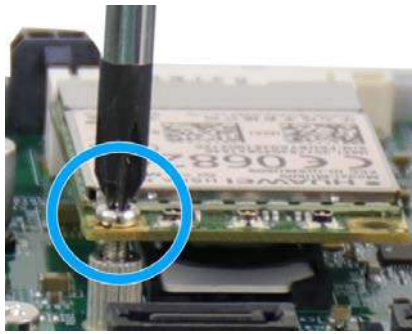

Secure the module

6. Clip on the IPEZ-to-SMA cable to the module and secure the antenna to the I/O panel. Please refer to the module's manual for clip-on connection.



Clip on IPEZ-to-SMA cable

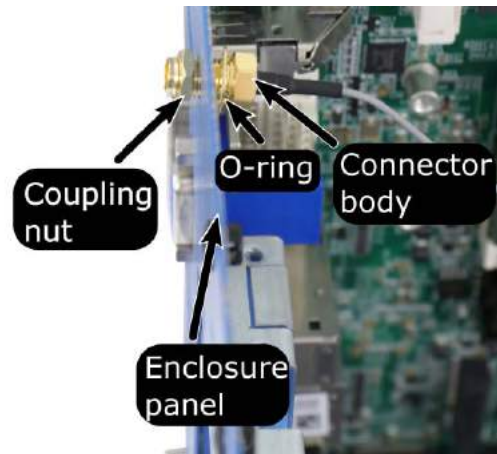

Secure antenna body to rear panel

7. Secure the external antenna to complete the installation.



8. [Reinstall the system enclosure](#) and panel when done.
9. If you need to install other components, please refer to respective sections.

3.2.4 M.2 2242 (B Key) Module and Micro-SIM (3FF) Card Installation

The system has an M.2 slot (indicated in **blue**) for installing 3G/ 4G or a WiFi module that can be coupled with dual Micro-SIM card slots (indicated in **red**). For installation, please refer to the following instructions.

1. Please refer to the section "[Disassembling the System](#)".
2. Locate the M.2 2242 (B Key) and SIM card slots on the motherboard.

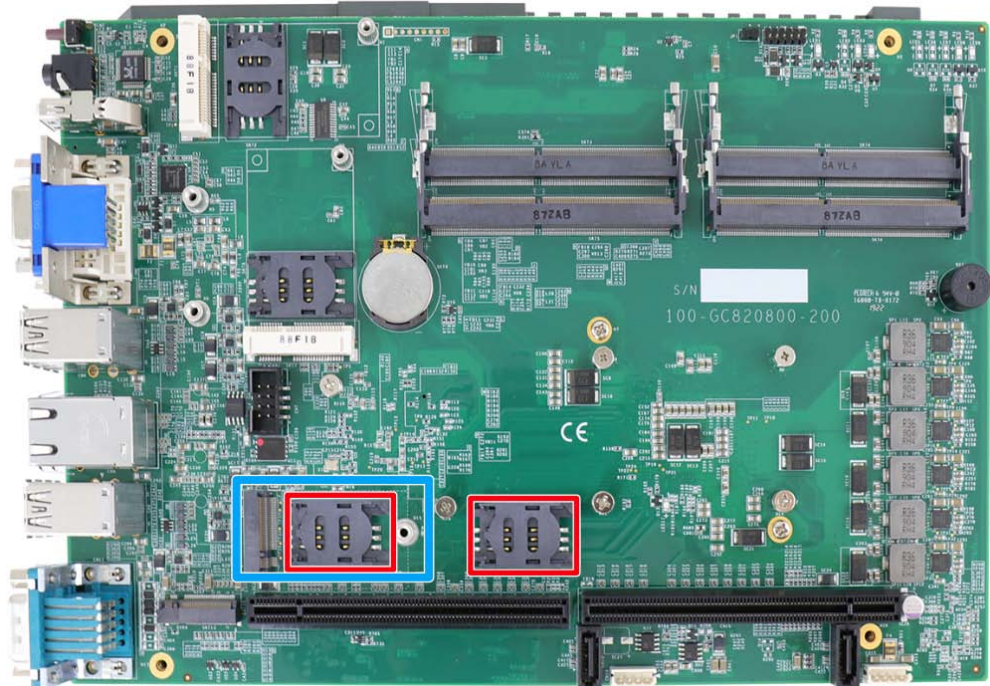

3. Before installing the mPCIe module, you need to insert the Mini-SIM card. Slide the SIM slot holder and lift the SIM card holder. Insert the Mini-SIM card (pins facing up), shut the SIM holder and slide it to lock the SIM card in-place.

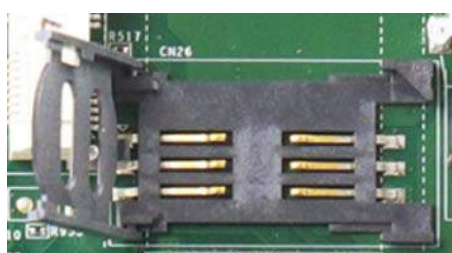

Slide and lift SIM card holder



Insert Mini-SIM card with pins facing up

4. Secure the SIM card by sliding the holder.



5. Insert the module on a 45 degree angle, gently press down and secure the module with an M2.5 P-head screw



Insert on 45 degree angle



Secure the module

6. Clip on the IPEZ-to-SMA cable to the module and secure the antenna to the front or rear panel. Please refer to the module's manual for clip-on connection.



Clip on IPEZ-to-SMA cable

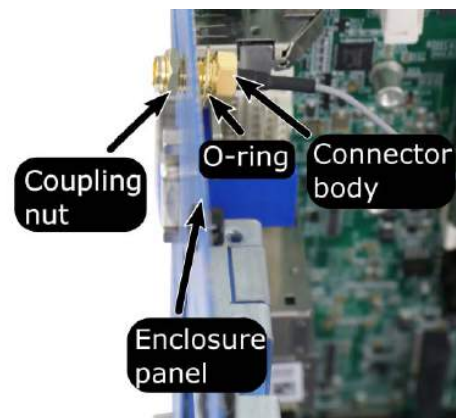

Secure antenna body to rear panel

7. Secure the external antenna to complete the installation.



8. [Reinstall the system enclosure](#) and panel when done.
9. If you need to install other components, please refer to respective sections.

3.2.5 M.2 (M Key) 2280 NVMe SSD or Intel® Optane™ Memory Installation

The system has a x4 PCIe M.2 (M key) 2280 slot for you to install an NVMe SSD for the ultimate performance or an Intel® Optane™ memory to accelerate the read/ write performances of traditional hard disk drive. An NVMe SSD offers exceptional performance over 2.5" SSDs while Intel® Optane™ memory can dramatically boost your traditional hard disk drives' read/ write performances. For installation, please refer to the following instructions.

1. Please refer to the section "[Disassembling the System](#)", you may not need to completely dismantle the system to gain access to the M.2 slot.
2. Locate the M.2 2280 slot on the motherboard

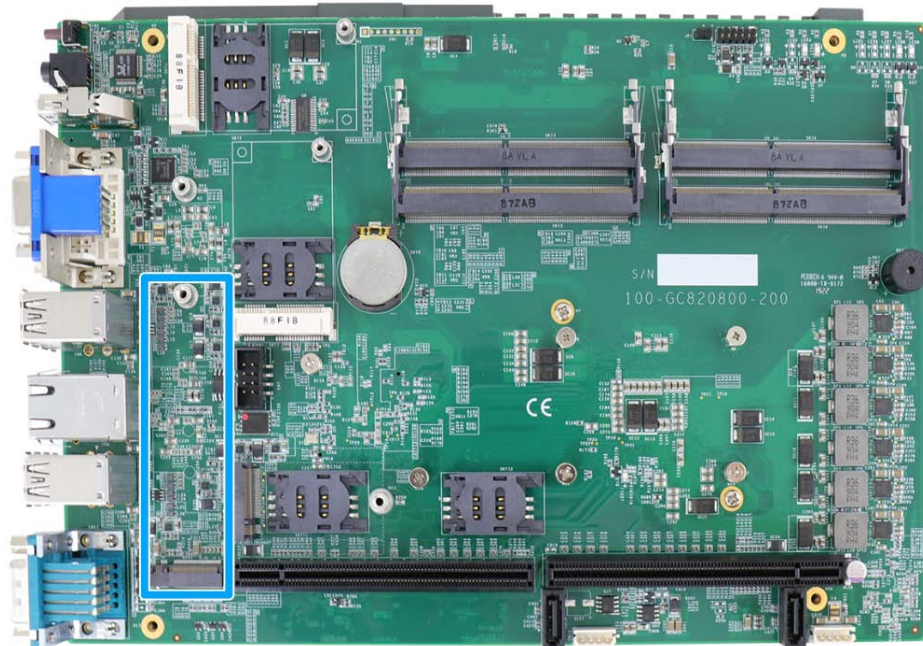

3. Insert the module on a 45 degree angle.



4. Gently press down and secure the module with an M2.5 P-head screw.

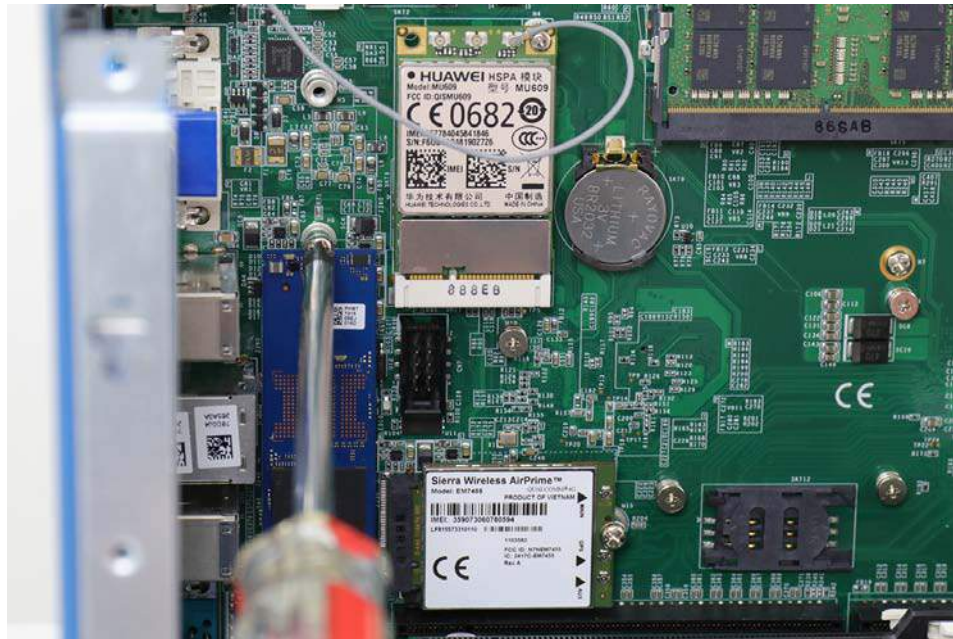

5. [Reinstall the system enclosure](#) and panel when done.
6. If you need to install other components, please refer to respective sections.
7. Please refer to the section [Intel® Optane™ Memory BIOS Setup and Driver Installation](#) for traditional hard drive acceleration.

3.2.6 Graphics Card Installation

 **WARNING**

To reduce the risk of damage, **DO NOT** remove the graphics card from the antistatic bag before it is ready to be installed into the Cassette module!

 **NOTE**

For installation compatibility, please consult with Neosys before purchasing a graphics card.

Nuvo-8208GC can support up to two 250W NVIDIA graphics cards. The placement of the rear exhaust fan creates a sealed wind tunnel to bring in cold air to the graphics cards and expels hot air to offer extreme system stability and reliability. To install a PCIe graphics card, please refer to the following procedure:

1. Please refer to the section "[Disassembling the System](#)".
2. Locate the PCIe x16 slots on the daughter board, indicated in **red** and **blue**. It is recommended to install your initial graphics card into the red PCIe slot as this makes the second graphics card installation procedure more convenient. For instruction and demonstration purposes, the following procedure will install into the **blue** PCIe slot.

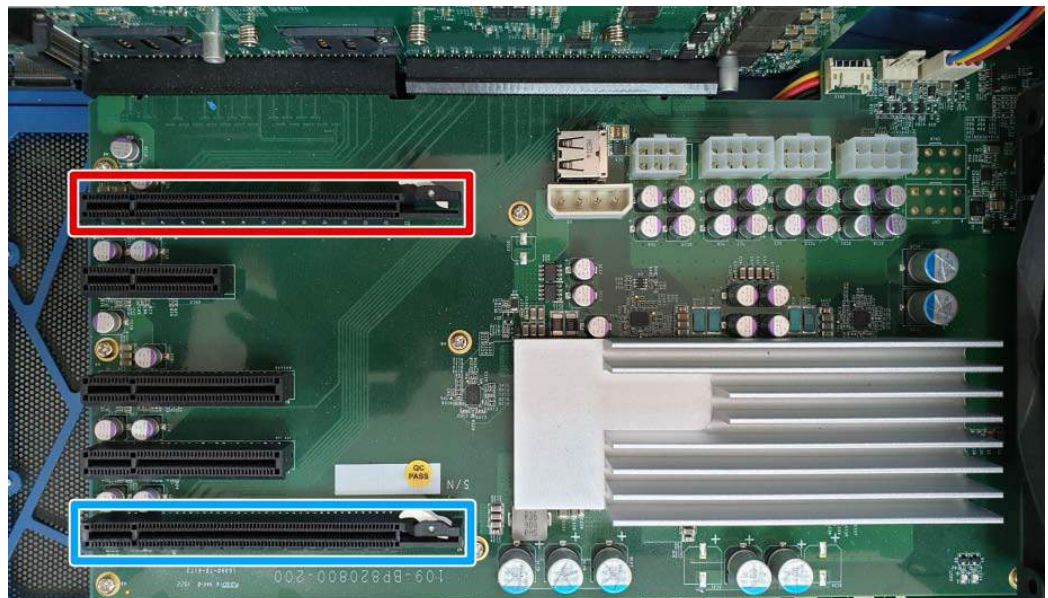

3. Remove the corresponding enclosure bezel(s) to the PCIe slot you wish to install to.



4. Remove the graphics card from the antistatic bag and gently lower it into the PCIe slot while ensuring the gold-fingers meet, graphics card panel is properly inserted and secured with screws.

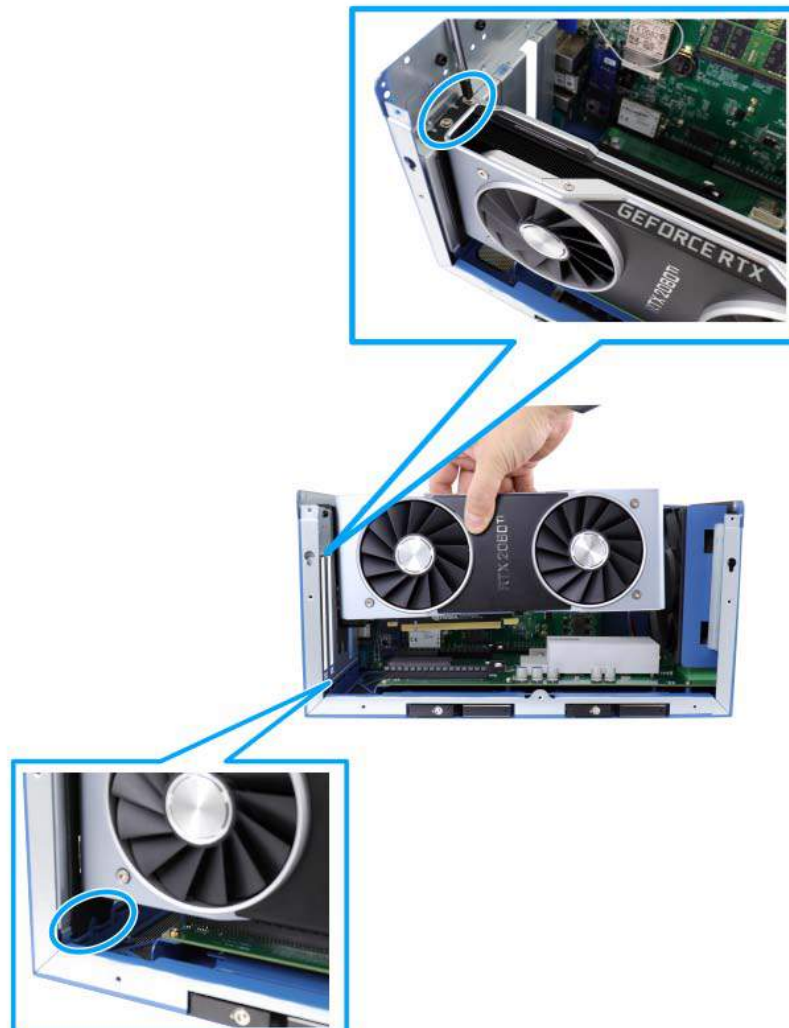

5. Connect power cables from the daughter board to the graphics card.

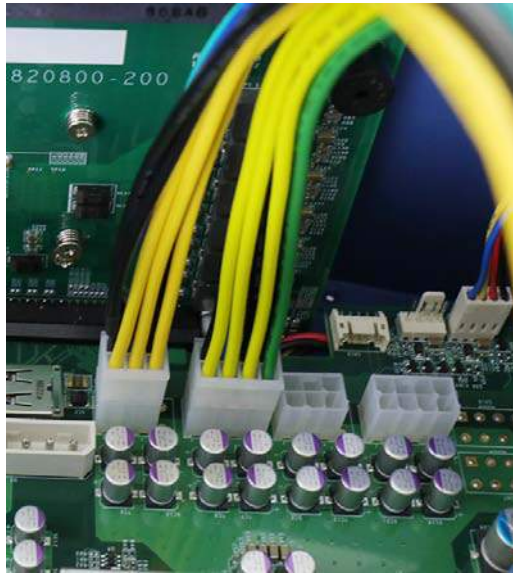

6/ 8-pin power connector on daughter board



6 or 8/ 8-pin power connector on graphics card



NOTE

Please make sure you use short power cables for the graphics card installed closest to the motherboard and long power cables for the graphics card installed furthest from the motherboard.

A variety of 6-pin to 8-pin / 8-pin to 8-pin power cables are provided, please refer to the packing list for details.

6. Please refer to the GPU bracket provided, please note that the screws indicated in **blue** allow the side-way adjustment of the graphics card; the screws indicated in **red** allow the positioning of the bracket along the graphics card; and the screws indicated in **green** gently pushes down and secures the graphics card in place.

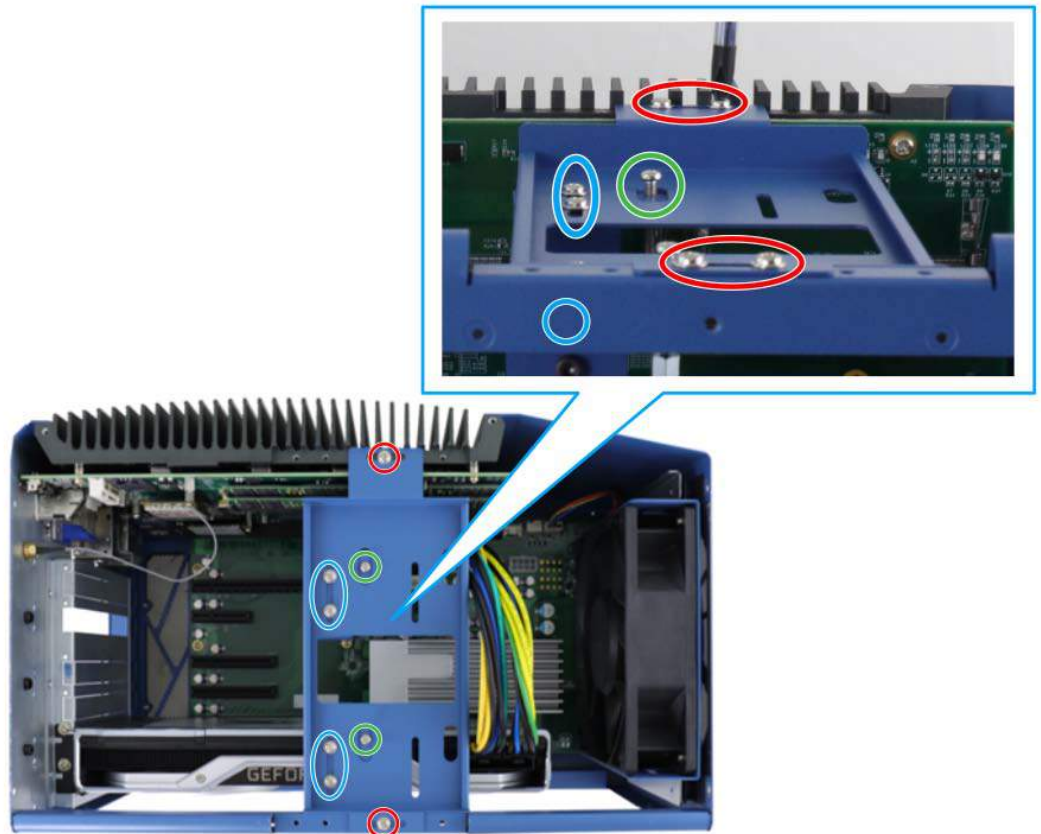

7. Gently lower the graphics card bracket onto the enclosure and graphics card. Make sure the position of the bracket **DOES NOT OBSTRUCT** graphics card's fan.



Lower and secure graphics card bracket

Make sure bracket **DOES NOT OBSTRUCT** graphics card's fan

8. Due to graphics card thickness, you need to adjust the bracket to firmly secure the graphics card. Use the hexa screw provided to adjust the bracket until it firmly clamps down the graphics card.

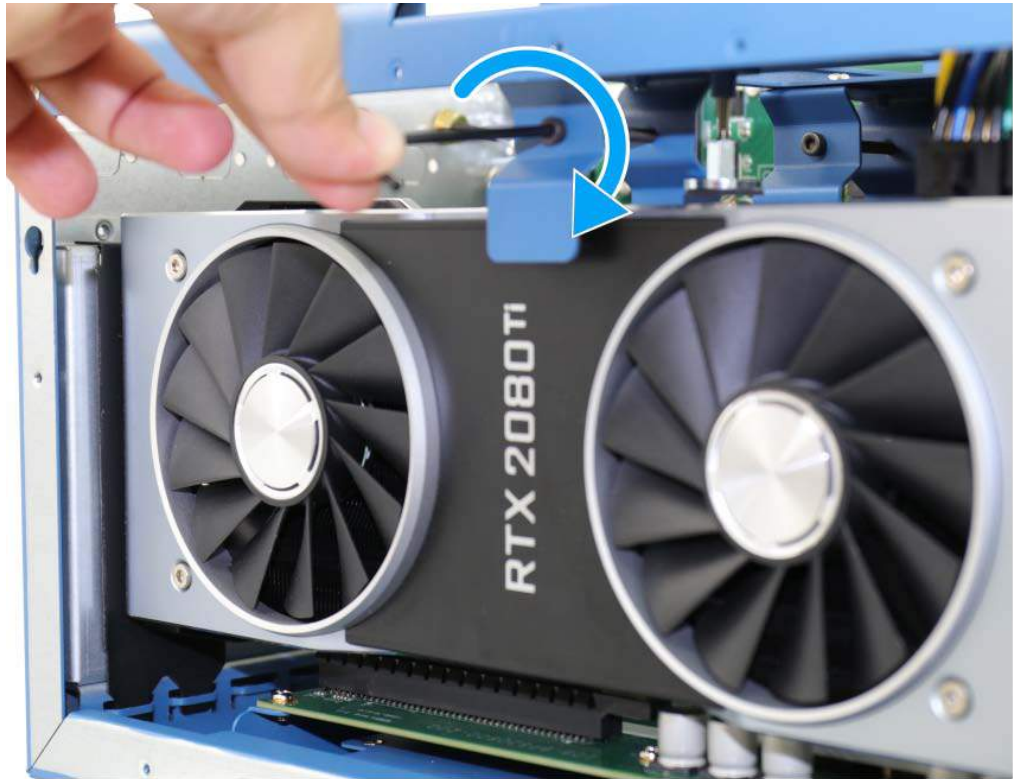

9. Repeat steps 3~7 if you need to install another graphics card.
10. [Reinstall the enclosure](#) and panel when done.
11. If you need to install other components, please refer to respective sections.

3.2.7 HDD/ SSD Installation

 **NOTE**
The system's hot swappable slots support up to 9mm 2.5inch SSD/ HDD specifications.

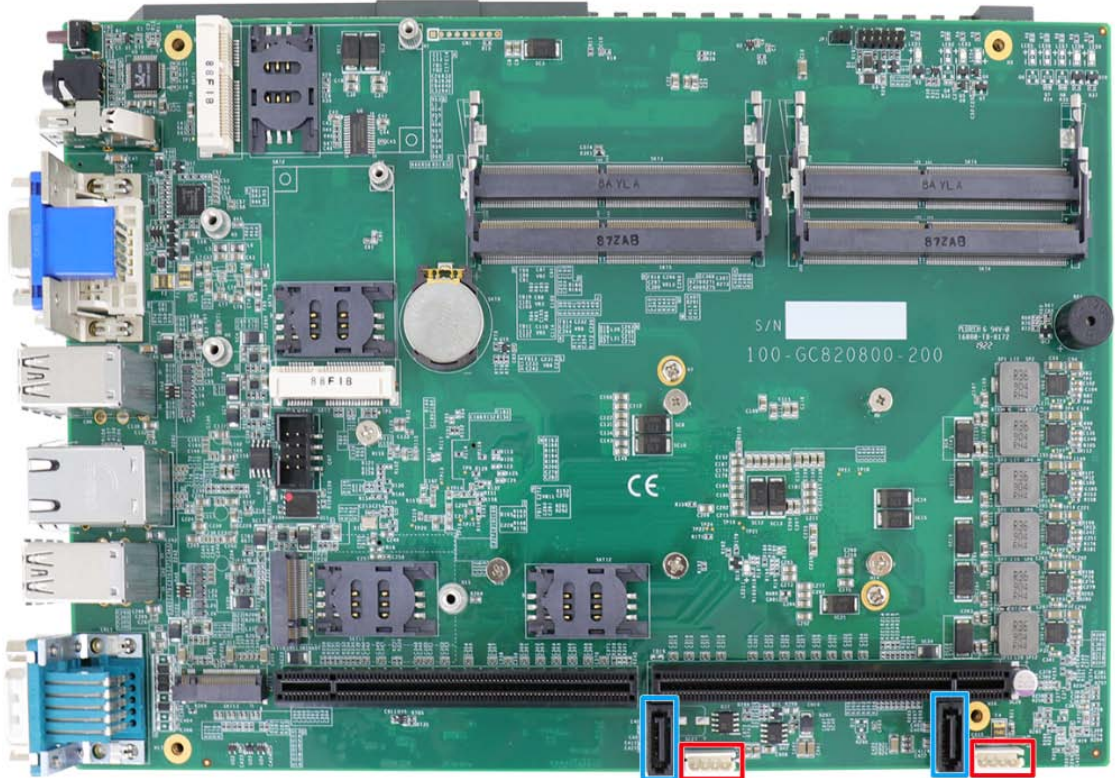

The system has two SATA ports (indicated in **blue**) and two four pin power connectors (indicated in **red**). The SATA and power cables should already be connected on the motherboard so users only need to install the HDD/ SSD. Please refer to the following instructions on how to install 2.5" SATA HDD/SSD.

1. The two hot-swappable slots are situated at the bottom, on the side of the enclosure.

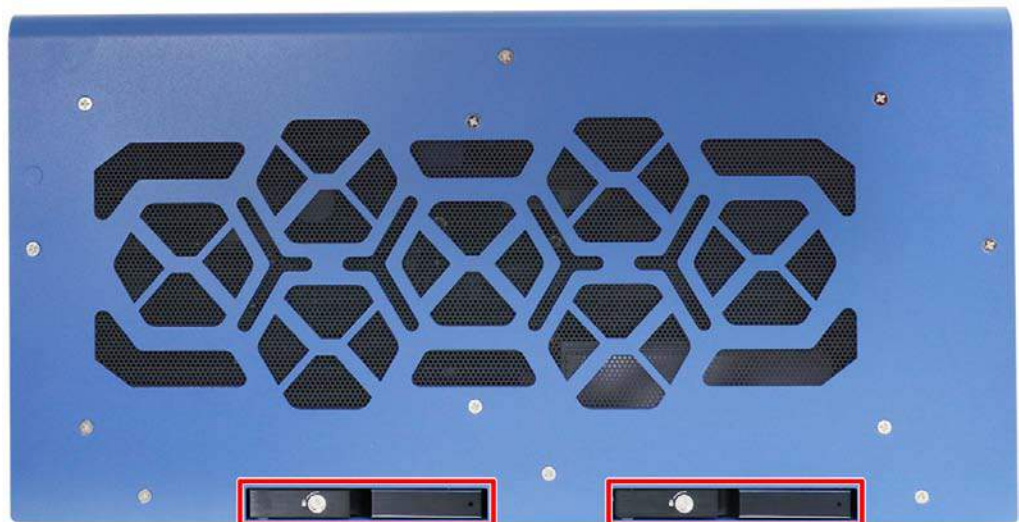

2. You may insert and install the HDD/ SSD without disassembling the enclosure. Simply lift to spring open the lever to gain access to the hot-swap slot.

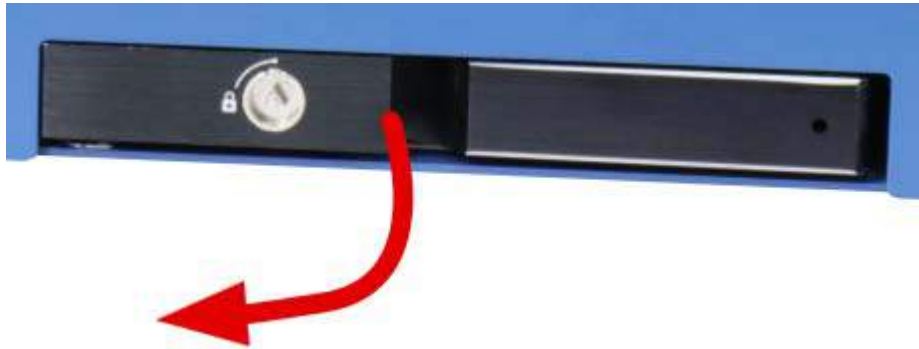

3. Insert the HDD/ SSD (with labels facing up) and the SATA connector end towards the slot, insert it 3/4 of way in and use the lever to fully push the HDD/ SSD into the slot. You should hear a click sound to ensure the HDD/ SSD is properly inserted and engaged.



4. Repeat steps 2 and 3 to install the other HDD/ SSD.
5. If you need to install other components, please refer to respective sections.

3.2.8 Ethernet Port Panel Screw Holes

The system's RJ45 Ethernet ports have panel screw holes (indicated in **blue circles**) for a firm cable connection.

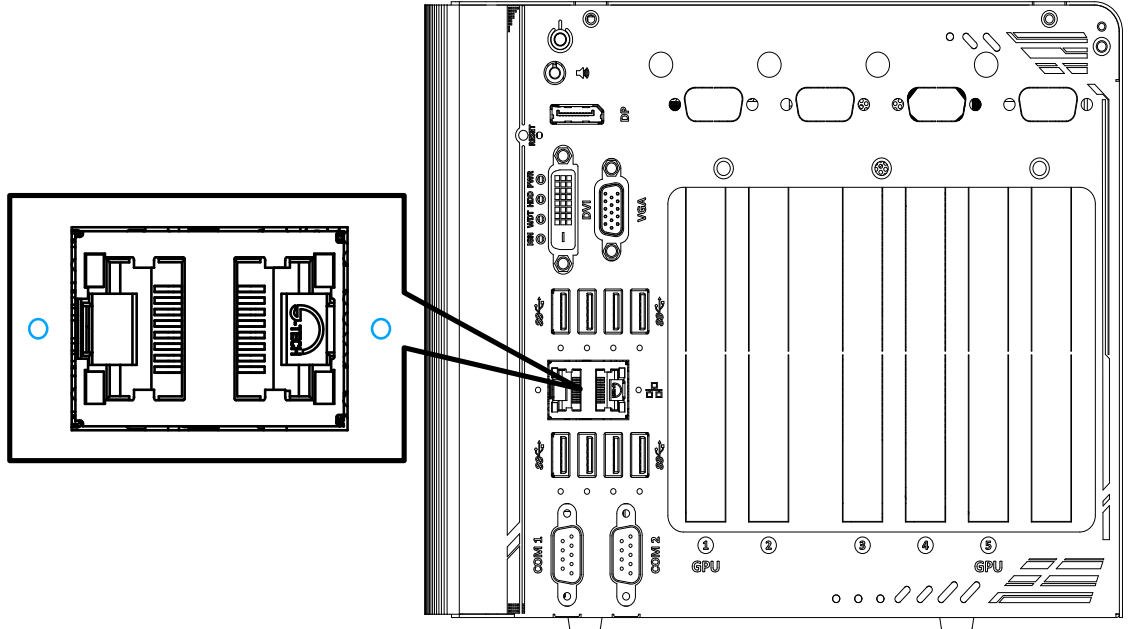

1. To install and make use to the panel screw hole connection, you must acquire cables with screws shown in the illustration below.



2. Simply insert the RJ45 connector into the RJ45 port and secure the top and bottom screws using your fingers or a screw driver.



3.3 Installing the System Enclosure

1. To reinstall the system enclosure, place the L-shape panel onto the enclosure while making sure the notch inside the panel is inserted into the slide-and-lock hinges.



Place L-shape side panel onto the enclosure

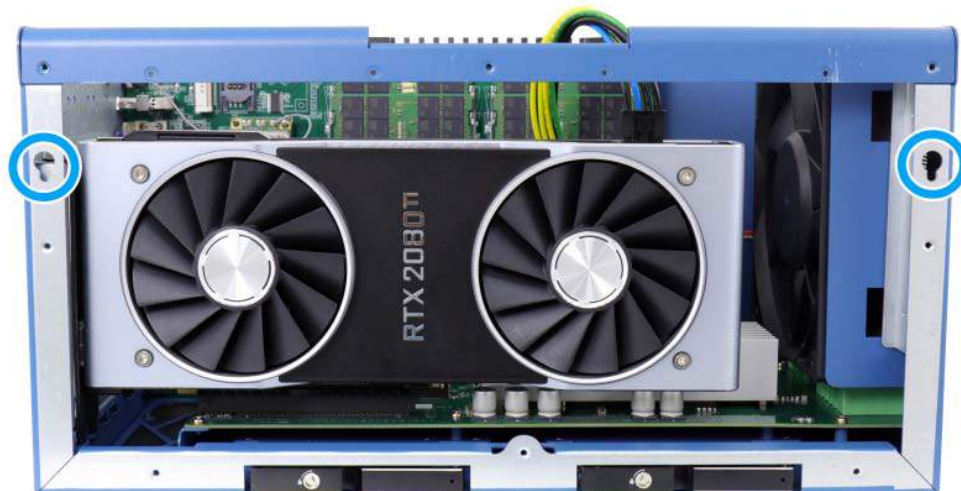

Slide-and-lock into the indicate hinges

- Secure the two screws indicated on the I/O panel.



- Secure the six screws indicated on the side panel.



- Secure the two screws indicated on the top of the enclosure.



- Secure the two screws indicated to complete the enclosure installation process.

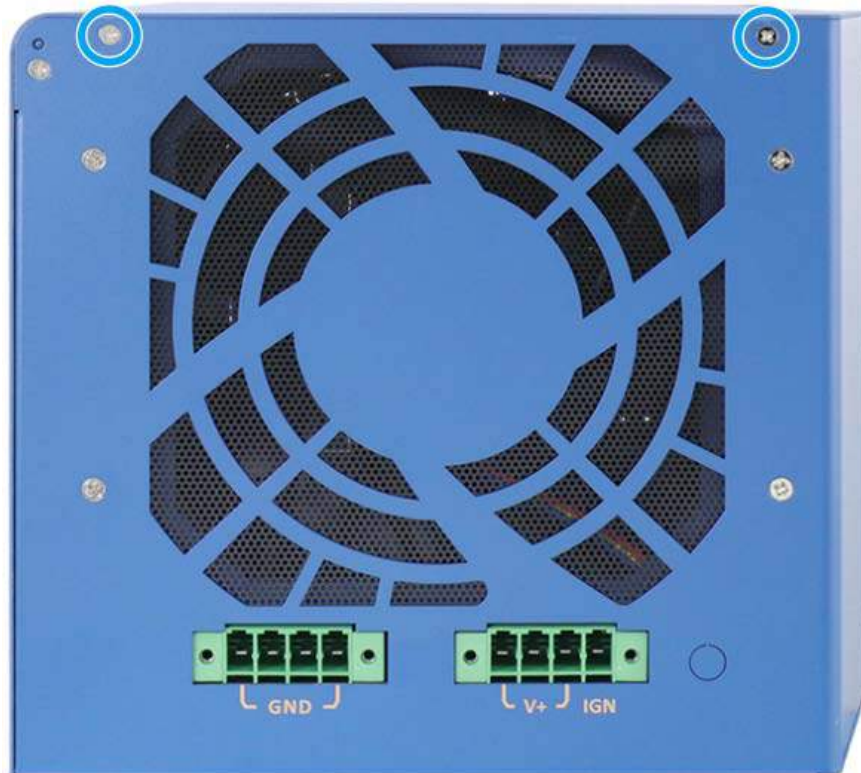

3.4 Mounting and Anti-vibration Damping Bracket Installation



NOTE

You will need to remove the four (4) rubber stands at the bottom of the enclosure if they have been attached.

The mounting and damping bracket offers superior operating vibration resistance up to 1Grm with HDD or up to 5Grm with SSD. Please refer to the Nuvo-8208GC exploded illustration below on installing damping and mounting brackets. The brackets, damping brackets and screws can all be found in the accessory box.

1. Take out anti-vibration damping bracket, eight M4 screws (red), eight sleeves (blue) and ten anti-vibration grommets (green) from the accessory box. Insert the M4 screws into the sleeves and through the anti-vibration grommets to secure the system to the bracket; and the bracket on top of a flat horizontal surface.

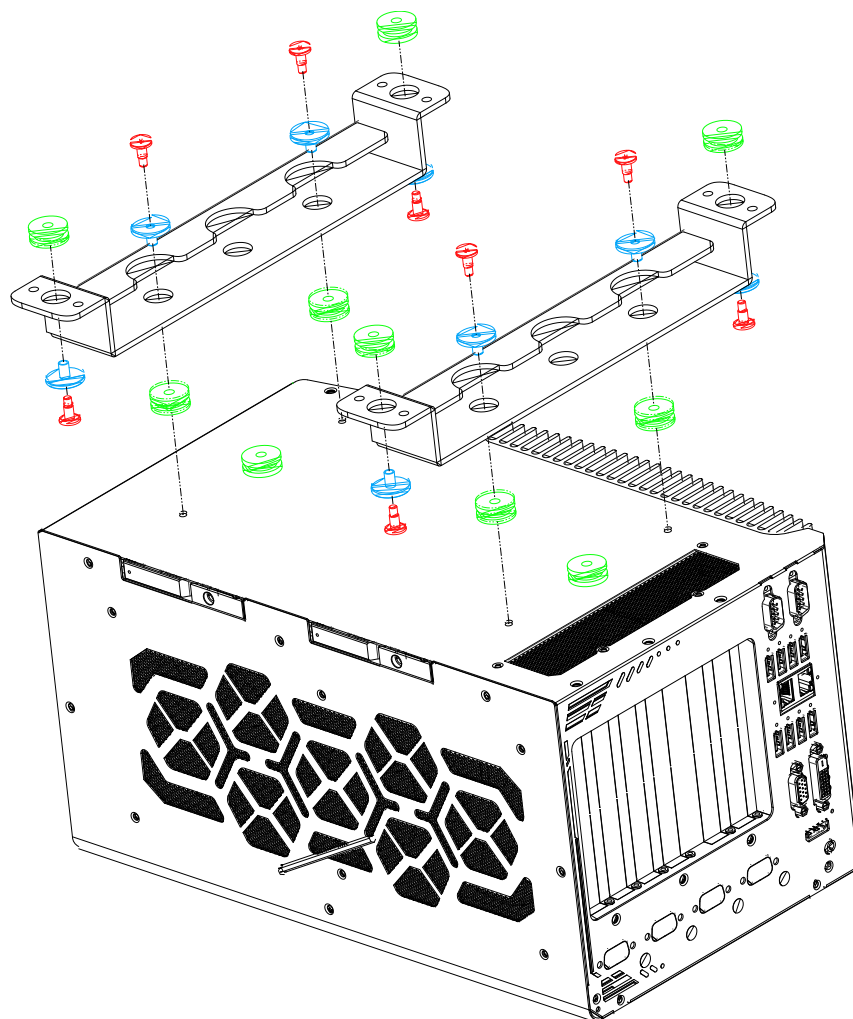

- Place the system on top of a flat horizontal surface and secure it with screws.

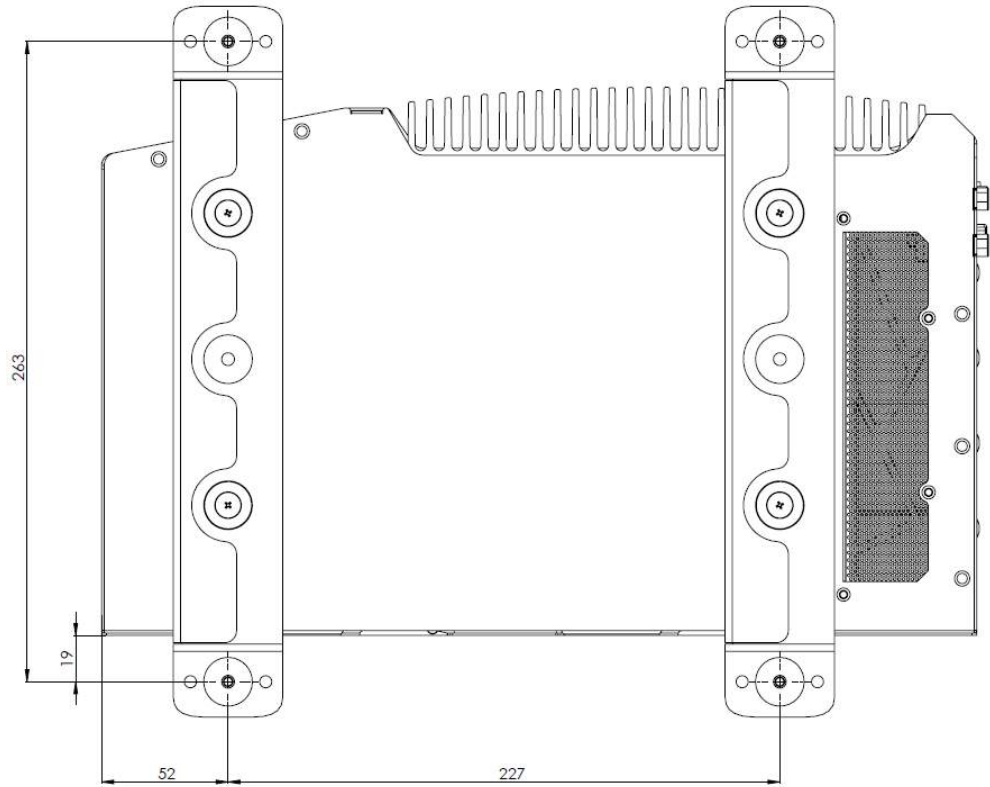

3.5 Powering On the System

There are three methods to power on the system

- Pressing the power button
- Sending a LAN packet via Ethernet (Wake-on-LAN)
- Powering on via ignition control (please refer to [Ignition Control](#) section)

3.5.1 Powering On Using the Power Button

This is the simplest way to turn on your system. The power button is a non-latched switch and behaves as the ATX-mode on/off control. With DC power connected, pushing the power button will turn on the system and the PWR LED indicator will light up. Pushing the button when system is on will turn off the system. If your operating system supports ATX power mode (i.e. Microsoft Windows or Linux), pushing the power button while the system is in operation will result in a pre-defined system behavior, such as shutdown or hibernation.

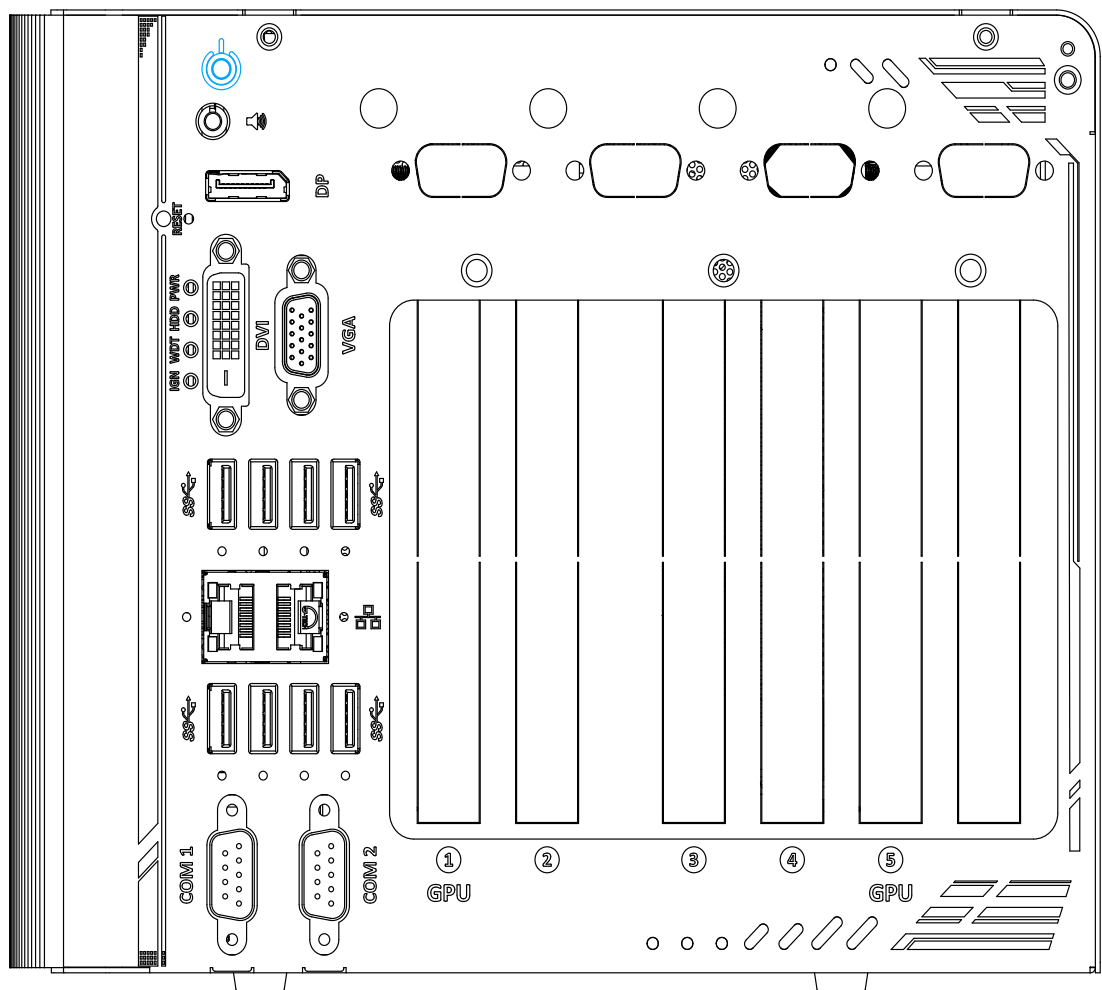

3.5.2 Powering On Using Wake-on-LAN

Wake-on-LAN (WOL) is a mechanism to wake up a computer system from a S5 (system off with standby power) state via issuing a magic packet. The system's Wake-on-LAN compatible GbE port is shown below.

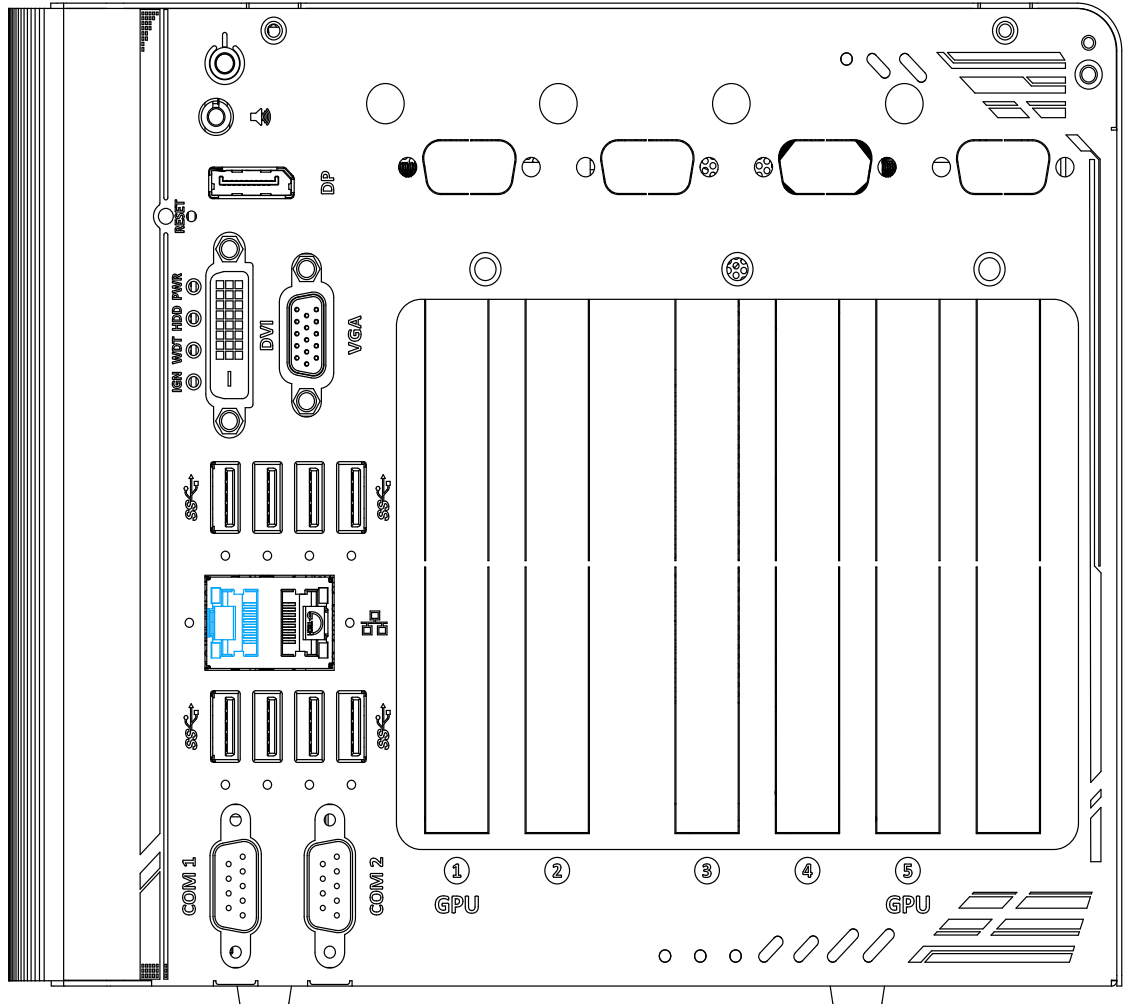

 **NOTE**

Please make sure the Intel chipset and Ethernet driver has been properly installed prior to setting up WOL function.

To enable WOL function, please set up WOL settings in the BIOS and in the operating system by follow the steps described below.

1. When the system boots up, press F2 to enter BIOS setup utility.
2. Go to the **[Power]>[Wake On LAN]** and set it to **[Enabled]**.
3. Press F10 to **“Save changes and exit BIOS”** and allow the system boot into the operating system.
4. Once booted into the Windows system, press **“Windows key + E”**, right-click on

“Network>Properties>Change adapter settings”. Locate and double-click on the adapter Intel® I219 Gigabit Network Connection, click on **Configure...**

5. Click on the **Power Management** tab and check the following options. Click on OK when done.

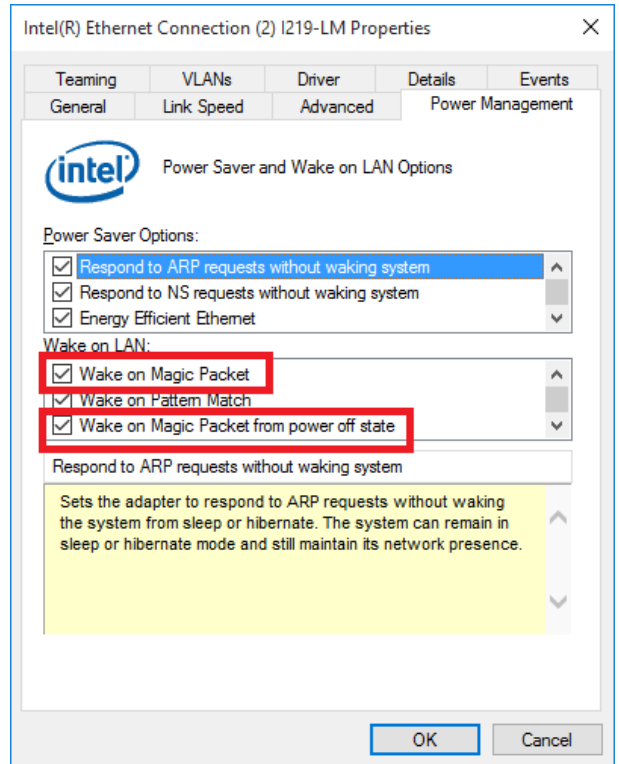

Magic Packet

The magic packet is a broadcast frame containing anywhere within its payload 6 bytes of all 255 (FF FF FF FF FF FF in hexadecimal), followed by sixteen repetitions of the target computer's 48-bit MAC address.

For example, NIC's 48-bit MAC Address is 78h D0h 04h 0Ah 0Bh 0Ch
 DESTINATION SOURCE MISC
 FF FF FF FF FF FF

78 D0 04 0A 0B 0C	78 D0 04 0A 0B 0C
78 D0 04 0A 0B 0C	78 D0 04 0A 0B 0C
78 D0 04 0A 0B 0C	78 D0 04 0A 0B 0C
78 D0 04 0A 0B 0C	78 D0 04 0A 0B 0C
78 D0 04 0A 0B 0C	78 D0 04 0A 0B 0C
78 D0 04 0A 0B 0C	78 D0 04 0A 0B 0C
78 D0 04 0A 0B 0C	78 D0 04 0A 0B 0C
78 D0 04 0A 0B 0C	78 D0 04 0A 0B 0C
78 D0 04 0A 0B 0C	78 D0 04 0A 0B 0C
MISC	CRC

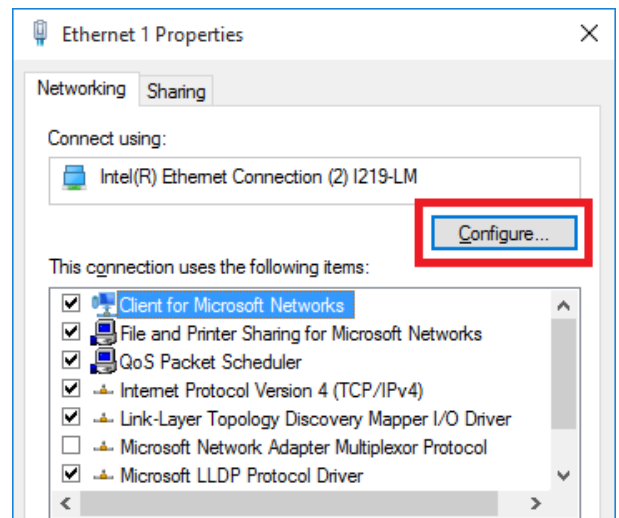

There are some free tools available on Internet that can be used to send a magic packet. Please refer to the following link to understand more about [Magic Packet](#).

3.6 Ignition Power Control

The ignition power control module for in-vehicle applications is a MCU-based implementation that monitors the ignition signal and reacts to turn on/off the system according to predefined on/off delay. Its built-in algorithm supports other features such as ultra-low power standby, battery-low protection, system hard-off, etc. In this section, we'll illustrate the principle of ignition power control and operation modes.

3.6.1 Principles of Ignition Power Control

The basic concept of ignition power control module is to control the timing correlation between ignition signal and system power status. A typical timing correlation is described in following diagram.

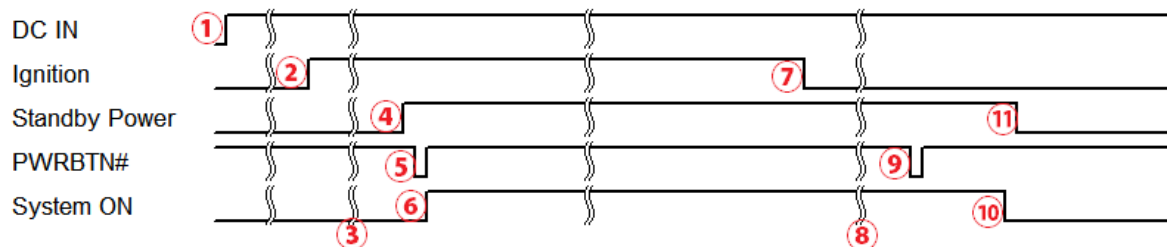

1. When DC power is supplied to the system, MCU starts to periodically detect ignition signal. Note that only MCU is working at this moment and the overall power consumption is less than 2 mW.
2. Ignition signal is active (both 12VDC and 24VDC ignition signals are accepted).
3. MCU starts to count a pre-defined power-on delay.
4. Once power-on delay expired, MCU turns on necessary standby power for the system (3.3VSB & 5VSB).
5. A PWRBTN# pulse is then issued to turn on the system (equivalent to one pressing the power button on the front panel).
6. The system is booting and becomes operational.
7. After a period of time, the ignition signal becomes inactive.
8. MCU starts to count a pre-defined power-off delay.
9. Once power-off delay expired, another PWRBTN# pulse is issued to perform a soft-off for the system (ex. a normal shutdown process for Windows system).
10. The system is completely shut down.
11. As MCU detects system is off, it turns off the standby power for the system, and operates in low power mode again (< 2mW power consumption).

3.6.2 Additional Features of Ignition Power Control

In addition to the typical timing correlation, the ignition power control module offers additional features to provide additional reliability for in-vehicle applications.

1. Low battery detection

The ignition power control module continuously monitors the voltage of DC input when the system is operational. If input voltage is less than 9V (for 12VDC input) or less than 18V (for 24VDC input) over a 60-second duration, it will shut down the system automatically.

2. Guarded power-on/ power-off delay duration

If ignition signal goes inactive during the power-on delay duration, the ignition power control module will cancel the power-on delay process and go back to idle status. Likewise if ignition signal goes active during the power-off delay duration, the ignition power control module will cancel the power-off delay process and keep the system running.

3. System hard-off

In some cases, system may fail to shutdown via a soft-off operation due to system/application halts. The ignition power control module offers a mechanism called “hard-off” to handle this unexpected condition. By detecting the system status, it can determine whether the system is shutting down normally. If not, the ignition power control module will force cut-off the system power 10 minutes after the power-off delay duration.

4. Smart off-delay

The ignition power control module offers two modes (mode 13 & mode 14) which have very long power-off delay duration for applications require additional off-line time to process after the vehicle has stopped. In these two modes, the ignition power control module will automatically detect the system status during the power-off delay duration. If the system has shutdown (by the application software) prior to power-off delay expiring, it will cut off the system power immediately to prevent further battery consumption.

3.6.3 Wiring Ignition Signal

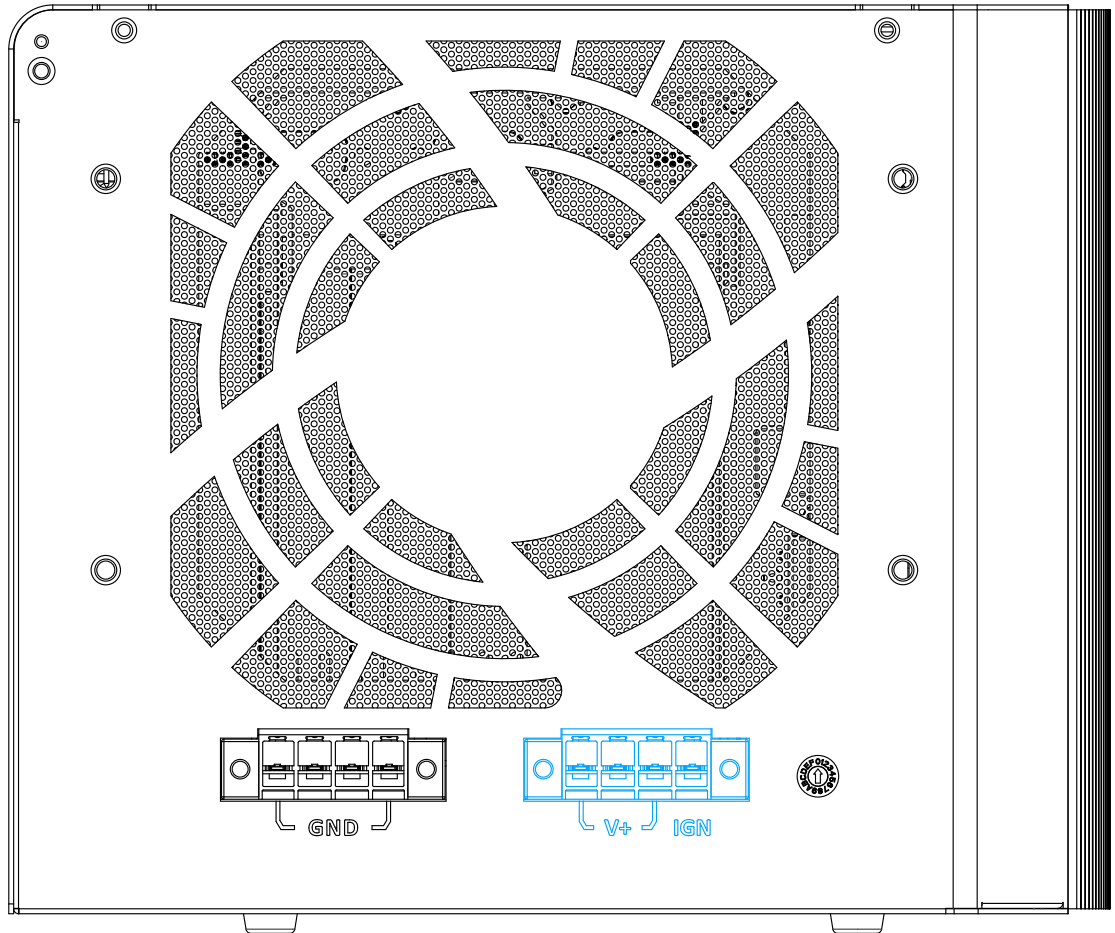

To have ignition power control for in-vehicle usage, you need to supply IGN signal to the system. The IGN input is located on the 4-pin pluggable terminal block (shared with DC power input). Below is the typical wiring configuration for in-vehicle applications.

1. Connect car Battery+ line (12V for sedan, 24V for bus/truck) to V+.
2. Connect car Batter-/ GND line to GND.
3. Connect ACC line to IGN.



WARNING

Please make sure your DC power source and IGN signal share the same ground.

IGN input accepts 8~48VDC. Supply a voltage higher than 48VDC may damage the system.

3.6.4 Configure your Windows system

When applying ignition power control to your system, please make sure you've configured your Windows system to initiate a shutdown process when pressing the power button. By default, Windows 7/ 8/ 10 goes to sleep (S3) mode when power button is pressed. As sleep (S3) is not a complete shutdown behavior, the ignition control function does not recognize the finish of a normal shut down process and thus users will encounter a system hard-off (power cut-off after 10 minutes). Please configure "When I press the power button" to "Shut down" in your Windows system settings.

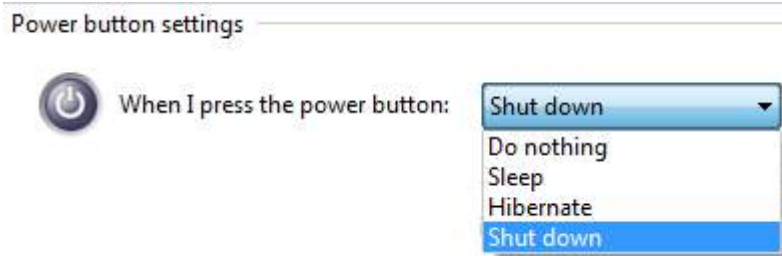

3.6.5 Operation Modes of Ignition Power Control

You can use the rotary switch to configure the operation mode. The system offers 16 (0~15) operation modes with different power-on/power-off delay configurations.

When rotary switch is set to mode 15 (0xF), the ignition power control is set to executed according to parameters configured in BIOS setup menu, which allows richer combination of power-on/ power-off delay and more detailed control parameters.

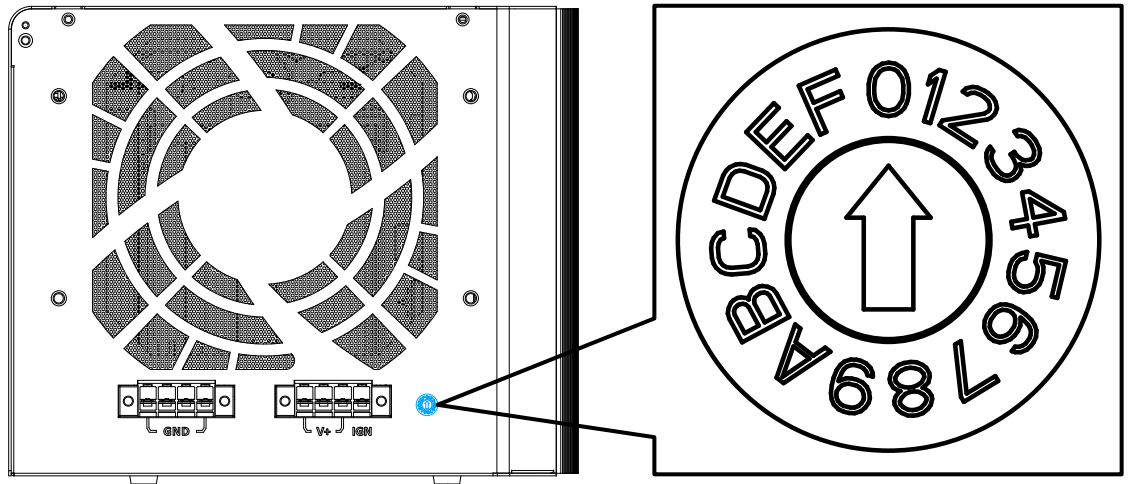

- **Mode 0**

Mode 0 is the ATX mode without power-on and power-off delay. User can only use the power button on the front panel to turn on or turn off the system.

Mode	Power-on Delay	Power-off Delay	Hard-off Timeout
0	N/A	N/A	N/A

- **Mode 1**

Mode 1 is AT mode without power-on and power-off delay. The system automatically turns on when DC power is applied. A retry mechanism is designed to repeat the power-on cycle if the system fails to boot up.

Mode	Power-on Delay	Power-off Delay	Hard-off Timeout
1	N/A	N/A	N/A

- **Mode 2**

Mode 2 is designed to have a very minor power on/ off delay of 160ms for applications that requires the system to start up almost at the same as the rest of the equipment it is working in collaboration with.

Mode	Power-on Delay	Power-off Delay	Hard-off Timeout
2	160ms	160ms	10 minutes

- **Mode 3 ~ Mode 12**

Mode 3 ~ Mode 12 have various power-on delay and power-off delay. Each mode supports a hard-off timeout of 10 minutes.

Mode	Power-on Delay	Power-off Delay	Hard-off Timeout
3	10 seconds	10 seconds	10 minutes
4	10 seconds	1 minute	10 minutes
5	10 seconds	5 minutes	10 minutes
6	30 seconds	1 minute	10 minutes
7	30 seconds	5 minutes	10 minutes
8	30 seconds	10 minutes	10 minutes
9	3 minutes	1 minute	10 minutes
10 (A)	3 minutes	10 minutes	10 minutes
11 (B)	3 minutes	30 minutes	10 minutes
12 (C)	10 minutes	30 minutes	10 minutes

- **Mode 13 (D) / Mode 14 (E)**

Mode 13 and Mode 14 are ignition power control modes with very long power-off delay. Both modes support the feature of “smart off-delay”, which automatically detect system status during power-off delay duration and cut off system power if system is off in prior to power-off delay expired.

Mode	Power-on Delay	Power-off Delay	Hard-off Timeout
13 (D)	30 seconds	2 hours	10 minutes
14 (E)	3 minutes	2 hours	10 minutes
15 (F)	Reserved		

[BIOS POST Check]

Enabled	This option secures a boot-to-OS operation. If the system is failed to boot to OS (e.g. disk failure or no bootable device) within 60 seconds, ignition control module will cut off system power and retry another power on cycle.
Disabled	BIOS POST check is skipped.

[Power On Delay]

Specifies the power-on delay duration. Once IGN signal goes active and sustains for the duration of power-on delay, ignition control module turns on system power and boot up the system.

[Power Off Delay]

Specifies the power-off delay duration. Once IGN signal goes inactive and sustains for the duration of power-off delay, ignition control module performs system shutdown (soft-off) and then cut off system power.

[Hard-off Timeout]

Specifies system hard-off timeout. Once system failed to normally shutdown via a soft-off operation due to system/application halts (e.g. Windows BSOD), ignition control module can compulsively cut off system power after the given hard-off timeout.

[Battery Voltage]

Specifies the battery voltage of the vehicle where System VTC is deployed. Typically it's 12 VDC for sedan and 24 VDC for bus/truck.

[Low Battery Threshold]

When system is running, ignition control module continuously monitors the battery voltage. Once the battery voltage is lower than the specified threshold, it performs system shutdown (soft-off) and cut off system power to prevent battery drain-out. You should specify the low battery threshold according to the given battery voltage.

Press F10 to "Save Changes and Exit". The ignition control module will be reset and operate according to parameters configured in BIOS setup menu.

4 System Configuration

4.1 BIOS Settings

The system is shipped with factory-default BIOS settings meticulously programmed for optimum performance and compatibility. In this section, we'll illustrate some of BIOS settings you may need to modify. Please always make sure you understand the effect of change before you proceed with any modification. If you are unsure of the function you are changing, it is recommended to change one setting at a time to see its effect(s).

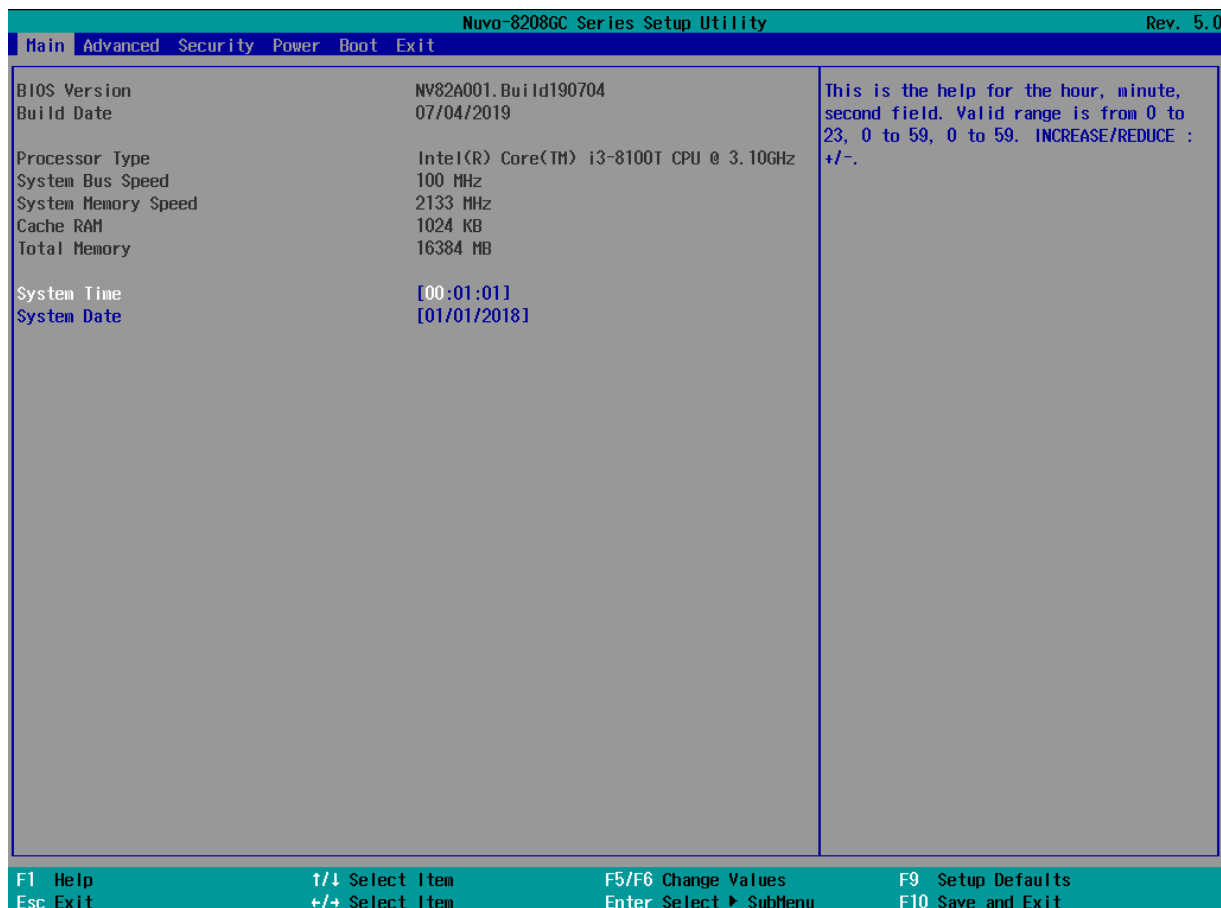

NOTE

Not all BIOS settings will be discussed in this section. If a particular setting/ function you are after requires specific BIOS settings but is not discussed in this section, please contact Neousys Technical Support staff.

4.1.1 COM Port Configuration

The system's [COM1/ COM2](#) ports support RS-232 (full-duplex), RS-422 (full-duplex) and RS-485 (half-duplex) mode. You can set the COM1 operating mode via BIOS settings. Another option in BIOS called "Slew Rate" defines how sharp the rising/falling edge is for the output signal of COM1. For long-distance RS-422/ 485 transmission, you may set the "Slew Rate" option as "High" to improve signal quality. For RS-422/485 communication, the "RS-422/ 485 Termination" option determines whether to enable/disable internal termination of RS-422/ 485 transceiver according to your wiring configuration (e.g. with or without external termination).

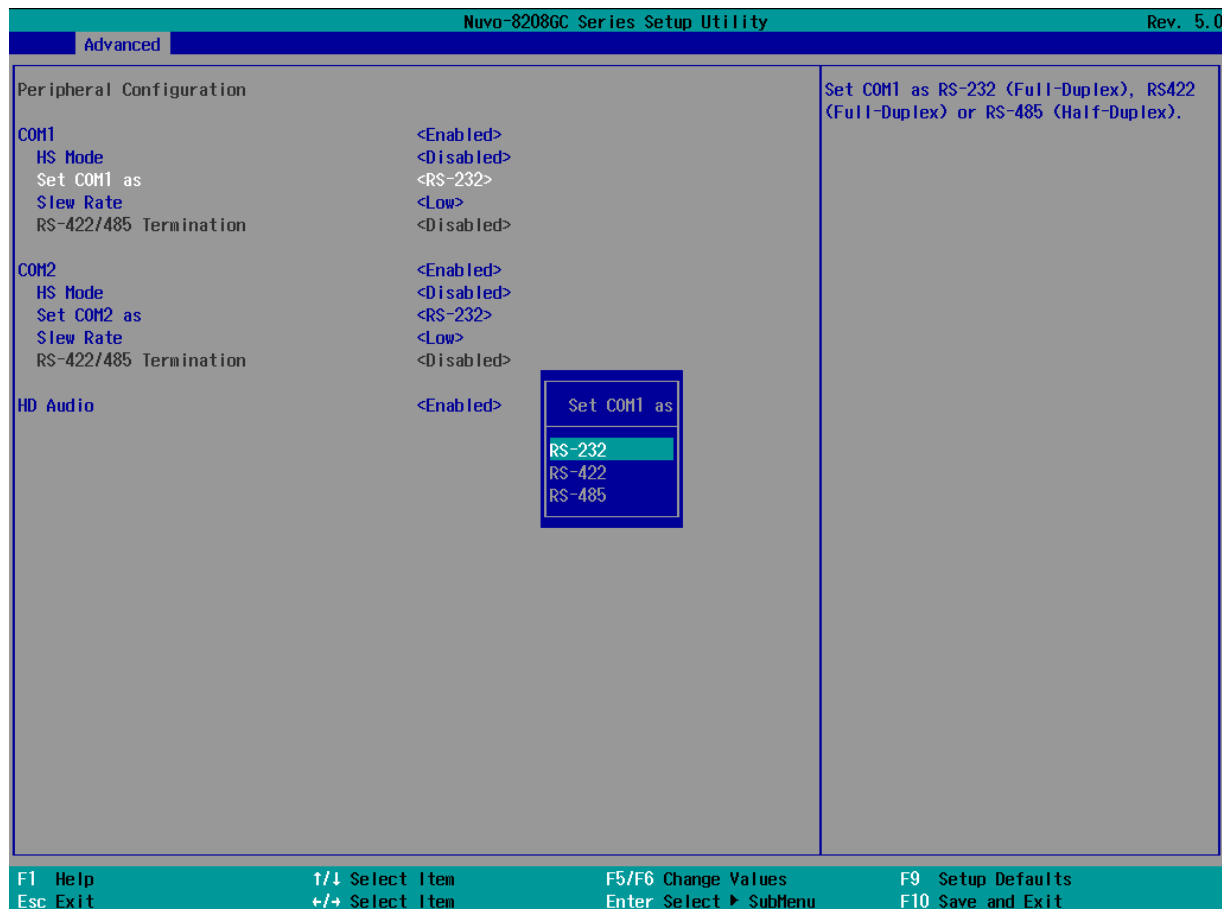

To set COM port operating mode:

1. Press **F2** when the system boots up to enter the BIOS setup utility.
2. Go to **[Advanced] → [Peripheral Configuration]**.
3. Set the **[Set COM1 Mode as]** option to the desired mode.
4. Once set, press **F10** to save setting and exit.

4.1.2 COM Port High Speed Mode

The high speed mode of each COM port effectively allows for the port's baud rate generator to operate at 8x the speed with an effective baud rate of 921,600 bps (115,200 x 8). Please refer to the following instructions on how to enable the high speed mode for your COM port (COM1 used as an example).

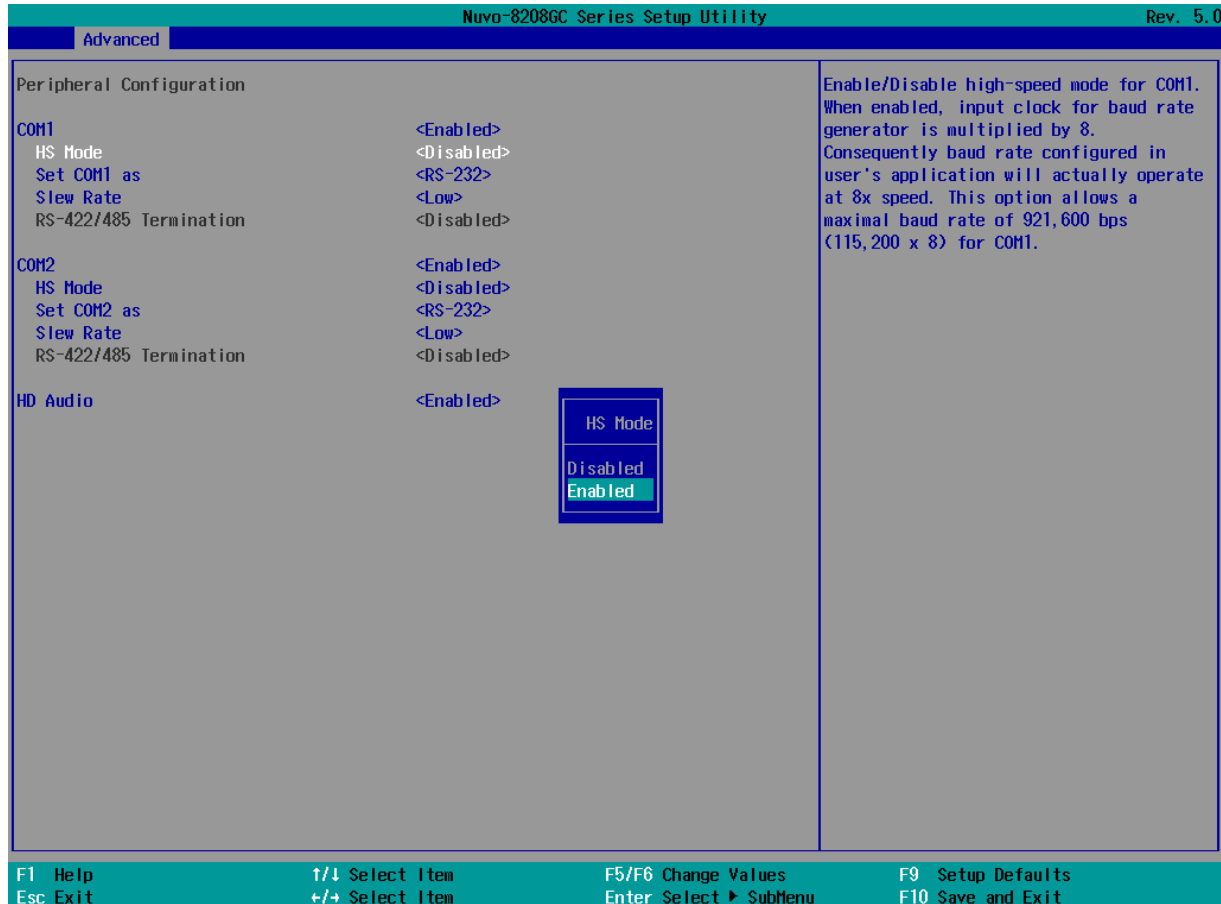

To set COM port high speed mode:

1. Press **F2** when the system boots up to enter the BIOS setup utility.
2. Go to **[Advanced] > [Peripheral Configuration]**.
3. Enable or set the **[Set COM1 Mode as]** option to the desired mode.
4. Highlight **[HS Mode]** and press ENTER to bring up options, highlight **[Enable]** and press ENTER.
5. Once set, press **F10** to save setting and exit.

4.1.3 Primary Display

This setting offers display output selection. Users can choose between Auto (auto detection), IGFX (integrated graphics card on CPU where applicable) or PEG (PCIe graphics card).

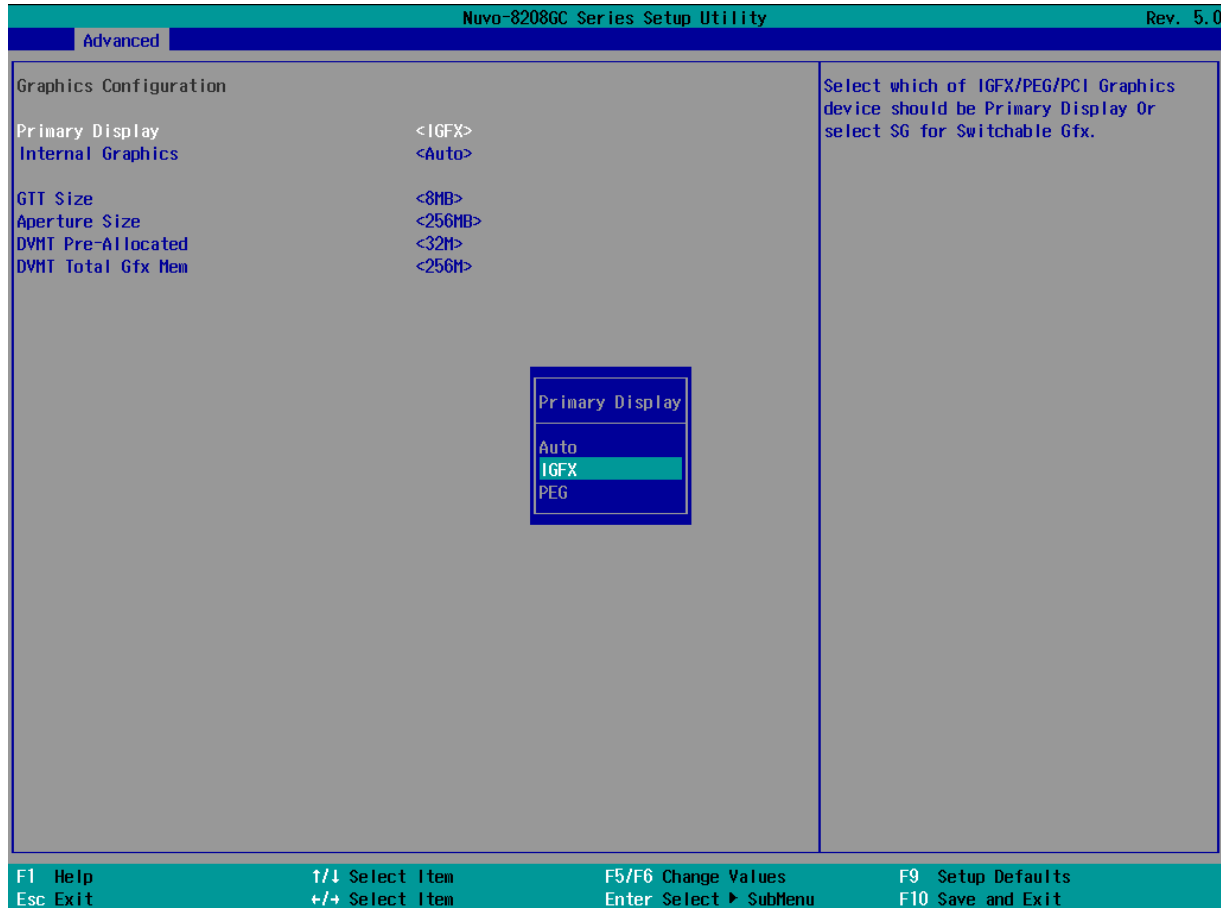

To set the primary display:

1. When system boots up, press F2 to enter BIOS setup utility.
2. Go to **[Advanced] > [System Agent (SA) Configuration] > [Graphics Configuration] > [Primary Display]** and press ENTER.
3. Use the arrow key to select your primary display settings: Auto/ IGFX/ PEG and press Enter to make your selection.
4. When done, press F10 to "Exit Saving Changes"

4.1.4 SATA Configuration

The SATA controller of your system supports two (2) operating modes: **AHCI** and **Intel RST Premium With Intel Optane System Acceleration mode**. The **AHCI** mode, which exposes SATA's advanced capabilities such as hot swapping and native command queuing, is supported in several later version of operating systems. The **Intel RST Premium With Intel Optane System Acceleration** mode allows the user to greatly accelerate SATA hard drive read/ write speeds by installing an Optane memory into the M.2 slot. Please refer to the section “**Intel RST Premium With Intel Optane System Acceleration**” for details.

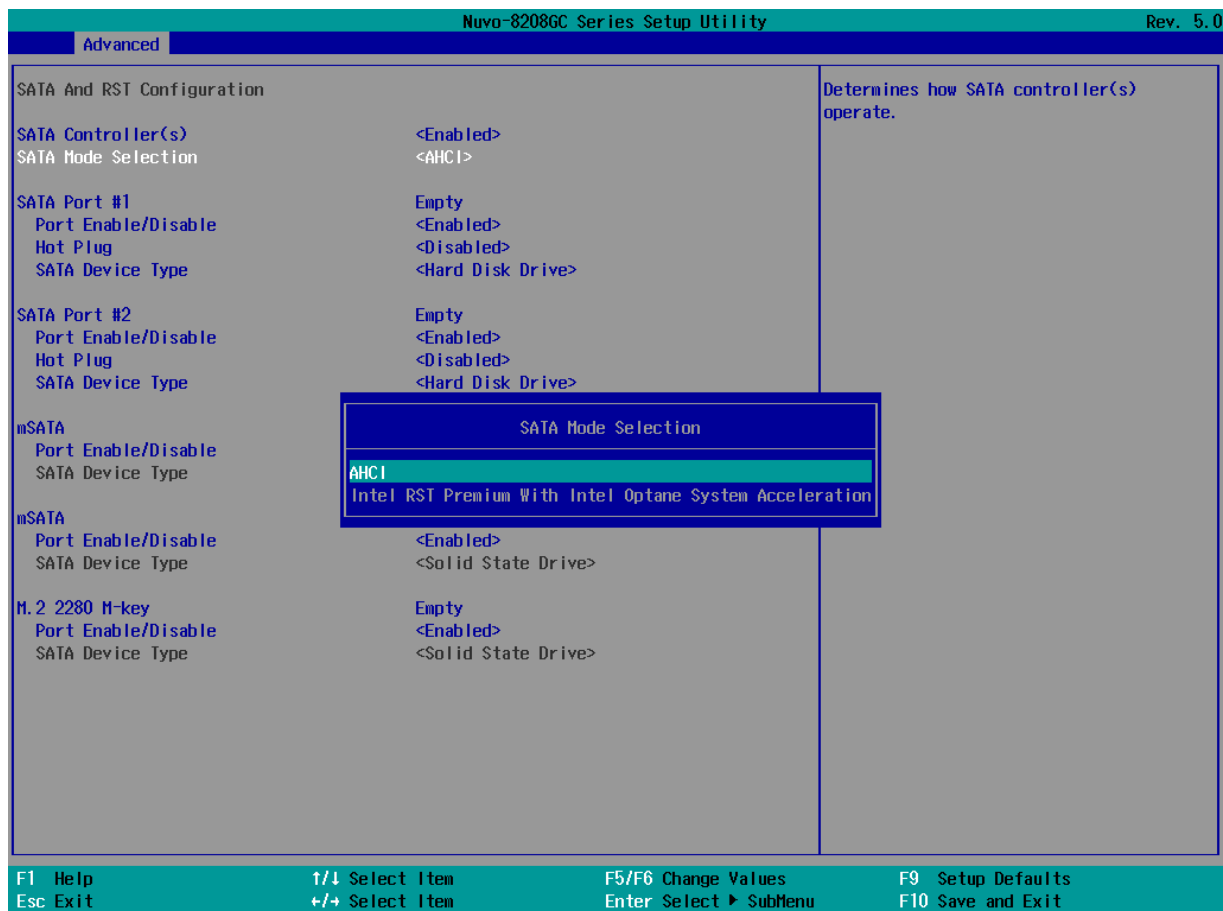

Recommended SATA controller mode settings:

- If you're using Windows Vista, Windows 10, or Linux with kernel 4.15.18 or later, you can select **AHCI** mode for better performance.
- If you are looking for faster hard drive read/ write performance, please install an SSD (M.2, mPCIe, SATA) or install an Intel® Optane™ memory for hard drive acceleration.

To set SATA controller mode:

1. When system boots up, press F2 to enter BIOS setup utility.
2. Go to **[Advanced] > [SATA Configuration]**.
3. Highlight the SATA, mSATA or M.2 port you wish to set and press ENTER to bring up setting options. Scroll to and highlight the setting you wish to set and press ENTER.



4. Repeat step 3 to set other SATA ports.
5. Press F10 to "Exit Saving Changes".

4.1.5 Fan Control Configuration

The fan control configuration allows users to set the fan operation mode to auto or fixed speeds operation. The auto mode configuration also offers minimum temperature setting to trigger the fan and the maximum temperature setting before the fan operates at 100% rotation speed.

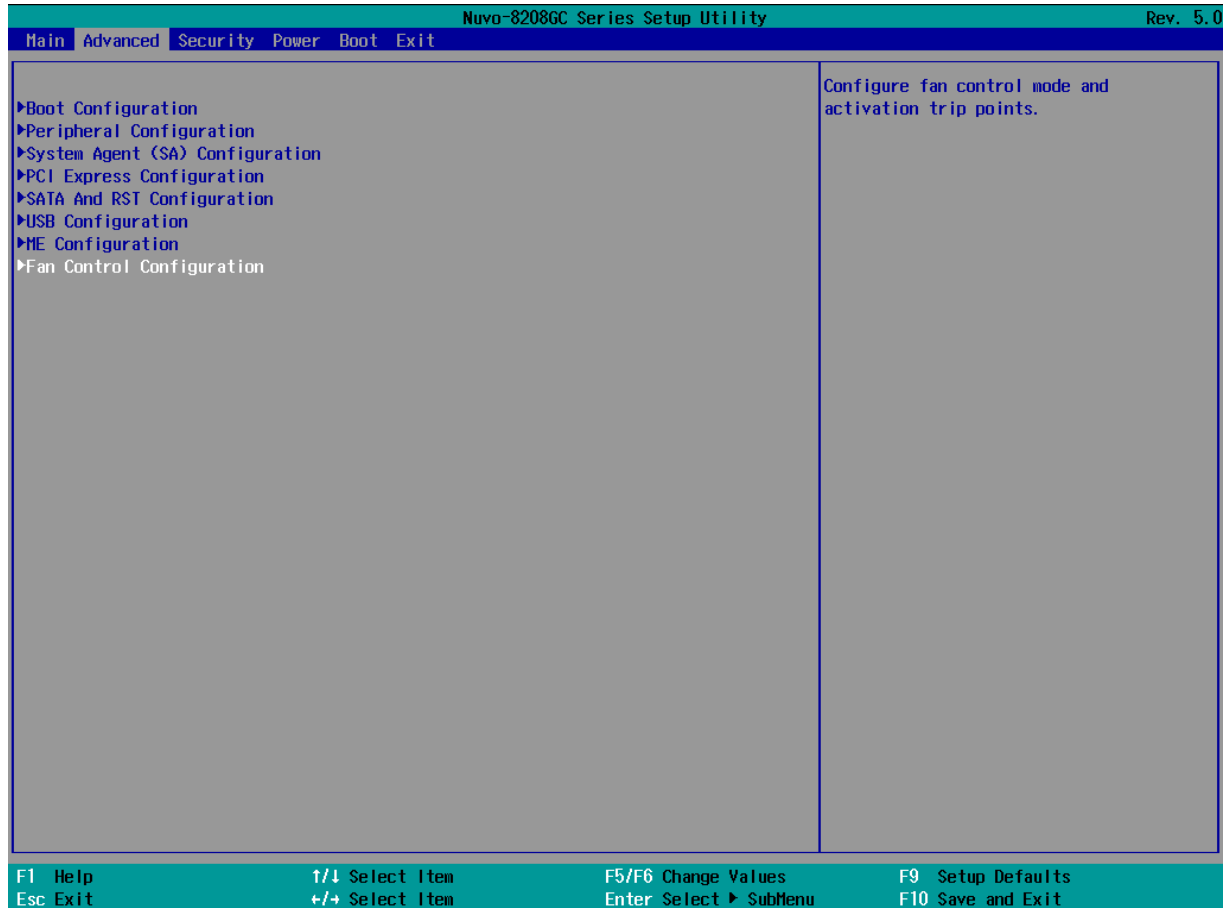

To set Fan Control Configuration to Auto mode:

1. When system boots up, press F2 to enter BIOS setup utility.
2. Go to **[Advanced]** > **[Fan Control Configuration]** and press ENTER.
3. To set auto fan control, highlight **[Fan Control Mode]** and press ENTER, highlight **[Auto]**

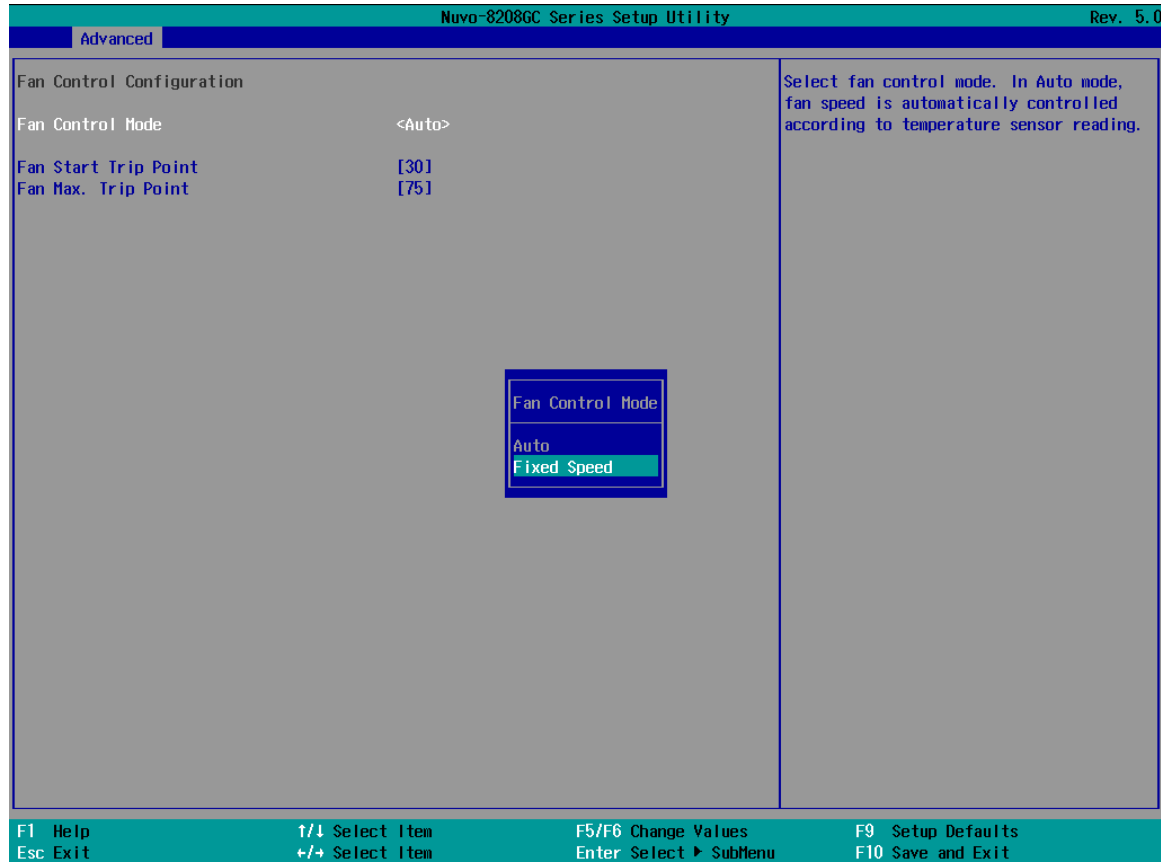

4. Use the up/ down arrow keys to highlight Fan Start Trip Point or Fan Max. Trip Point and press ENTER, a window appears and you may enter the temperature in degree Celsius.

- **Fan Start Trip Point:** The minimum temperature which the fan being to operate
- **Fan Max. Trip Point:** The maximum temperature where the fan begins to operate at 100% rotation speed



5. When done, press F10 to “Exit Saving Changes”.

To set Fan Control Configuration to Fixed Speed mode:

1. When system boots up, press F2 to enter BIOS setup utility.
2. Go to **[Advanced]** > **[Fan Control Configuration]** and press ENTER.
3. To set auto fan control, highlight **[Fan Control Mode]** and press ENTER, highlight **[Fixed Speed]**.

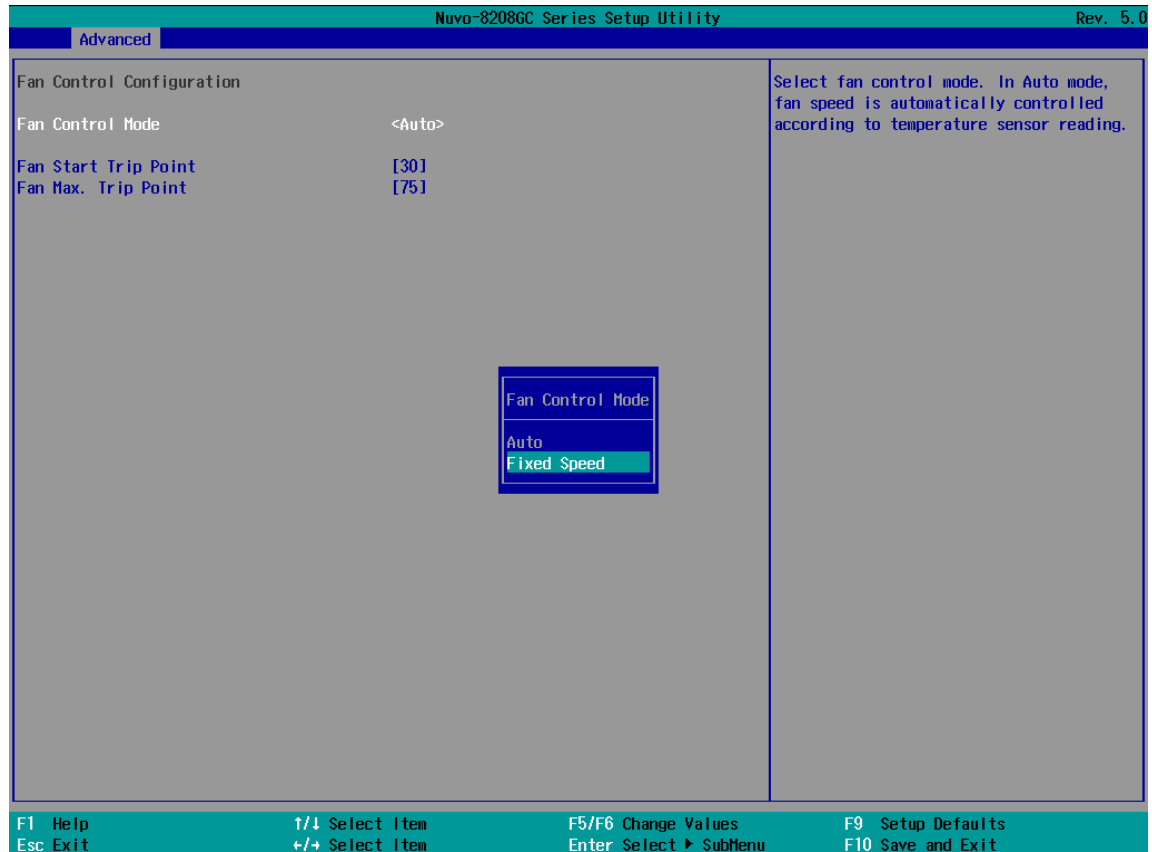

4. Highlight **[Fan Speed]** and press ENTER.
5. A window appears and you may use the up/ down arrow keys to select between 20~100% as your fixed fan rotation speed.

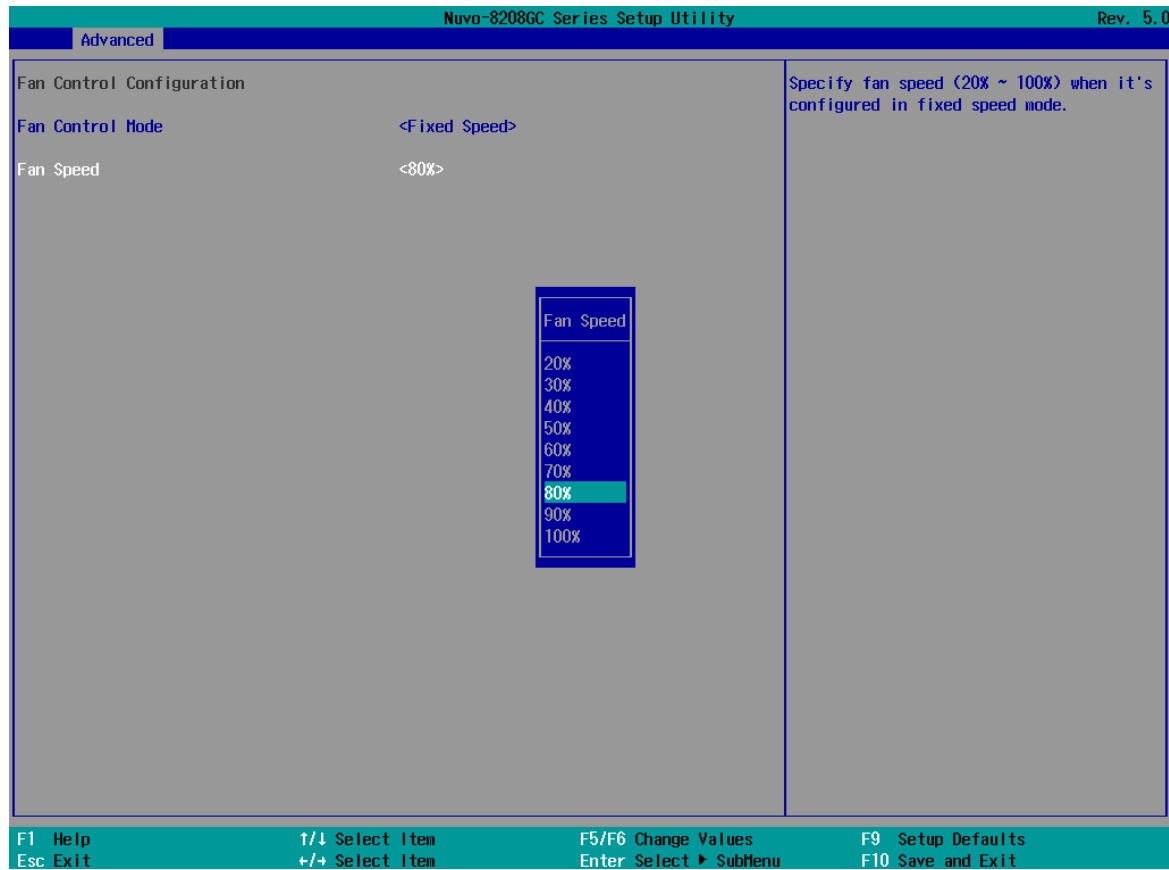

6. When done, press F10 to “Exit Saving Changes”.

4.1.6 TPM Availability

Trusted Platform Module (TPM) is a hardware-based cryptoprocessor to secure hardware by integrating cryptographic keys into devices. The system is designed with on-board TPM 2.0 module. As TPM 2.0 requires 64-bit Windows 7/8/10 with UEFI boot mode, it is disabled in BIOS by default. For customers who want to utilize TPM feature, you will need to enable TPM in BIOS as well as install Windows with UEFI mode.

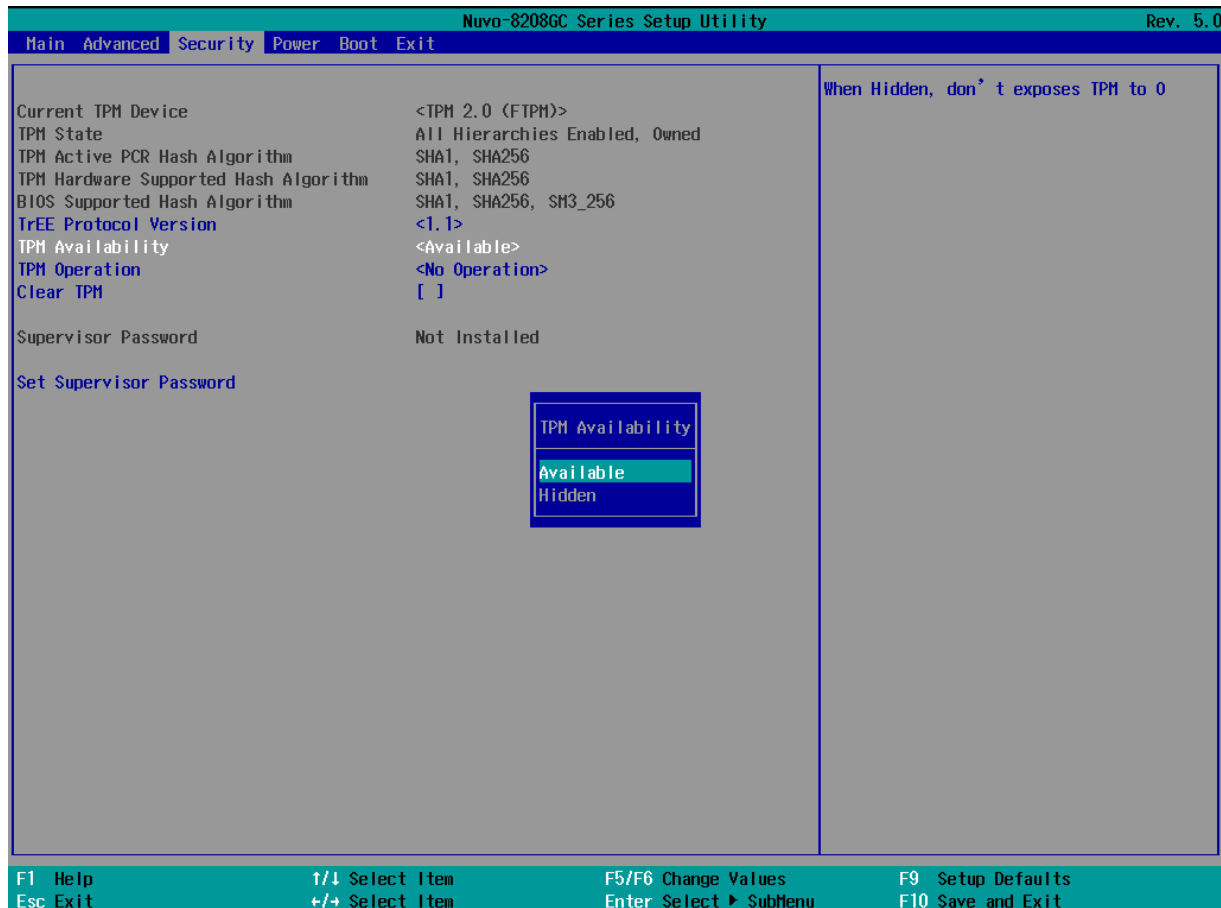

To enable TPM availability:

1. When system boots up, press F2 to enter BIOS setup utility.
2. Go to **[Security] > [TPM Availability]**, press ENTER to bring up Options, Available/Hidden.
3. Highlight your selection, press ENTER and press F10 to “Exit Saving Changes”.

4.1.7 Auto Wake on S5

When the system is set to operate in S5 state, the user can specify a time to turn on the system, daily or monthly.



Value	Option	Description
Auto Wake on S5	Disabled	The system does not turn on when operating in state S5.
	By Every Day	The system turns on each day when operating in state S5. Specify the time of day.
	By Day of Month	The system turns on each month when operating in state S5. Specify the day and time.

Highlight your selection, press ENTER and press F10 to “Exit Saving Changes”.

4.1.8 Power On After Power Failure Option

This option defines the behavior of System series when DC power is supplied.

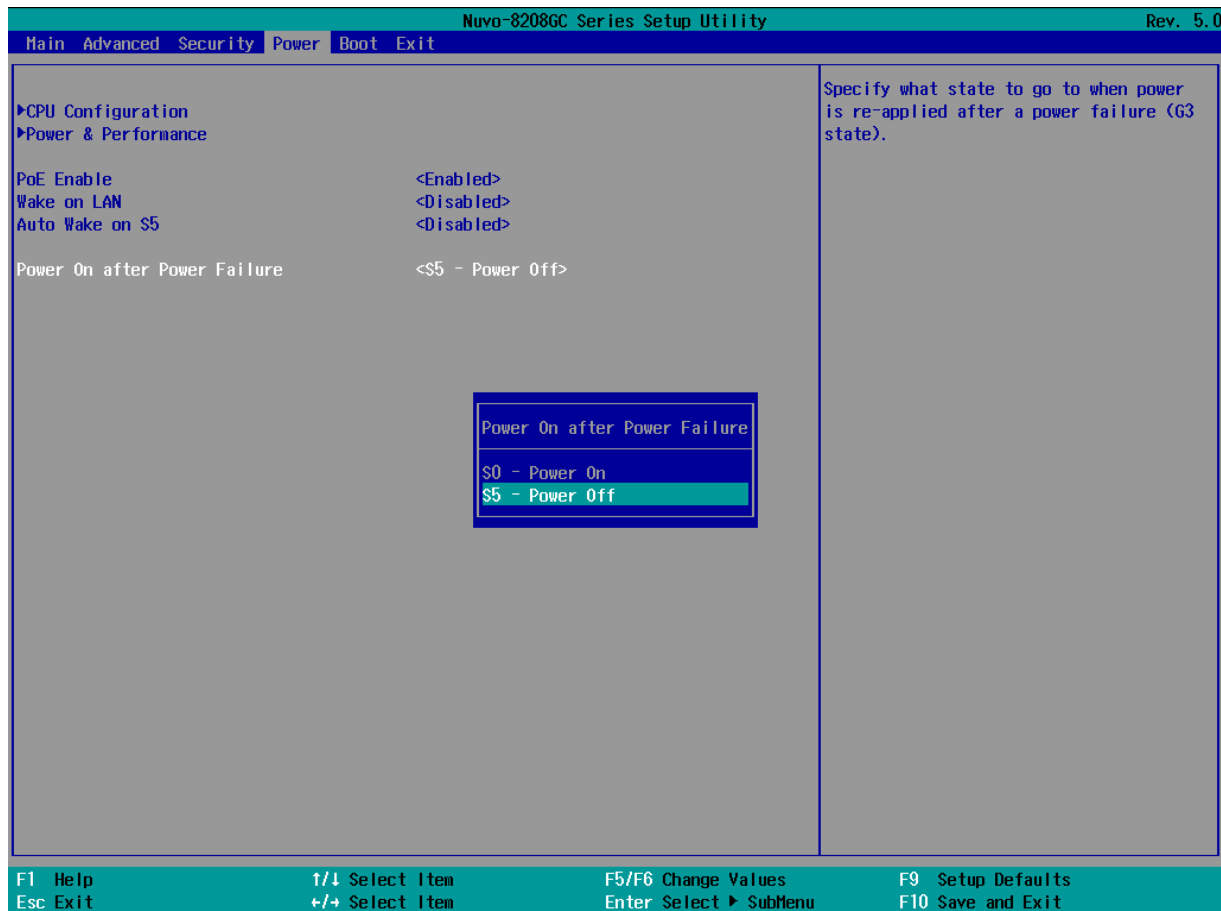

Value	Description
S0 – Power On	System is powered on when DC power is supplied.
S5 – Power Off	System is kept in off state when DC power is supplied.

To set “Power On after Power Failure” option:

1. When system boots up, press F2 to enter BIOS setup utility.
2. Go to **[Power] > [Power On after Power Failure]**.
3. Scroll down to highlight **[Power On after Power Failure]**, press ENTER to bring up setting options, S0 – Power On or S5 – Power Off, and press ENTER to select the setting.
4. Press F10 to “Exit Saving Changes”.

4.1.9 Power & Performance (CPU SKU Power Configuration)

The system supports various 9th/ 8th-Gen Core i and Xeon CPUs. A unique feature, “**SKU Power Config**” is implemented in BIOS to allow users to specify user-defined SKU power limit. Although the system is designed to have best thermal performance with CPUs of 35W TDP, you can install a 65W CPU and limit its SKU power (to 35W) to obtain more computing power. This feature gives you the flexibility of CPU selection and great balance between computing power and operating temperature range. Depending on the CPU installed, SKU Power Config settings may include Max/ 65W/ 45W/ 35W/ 25W/ 15W options.

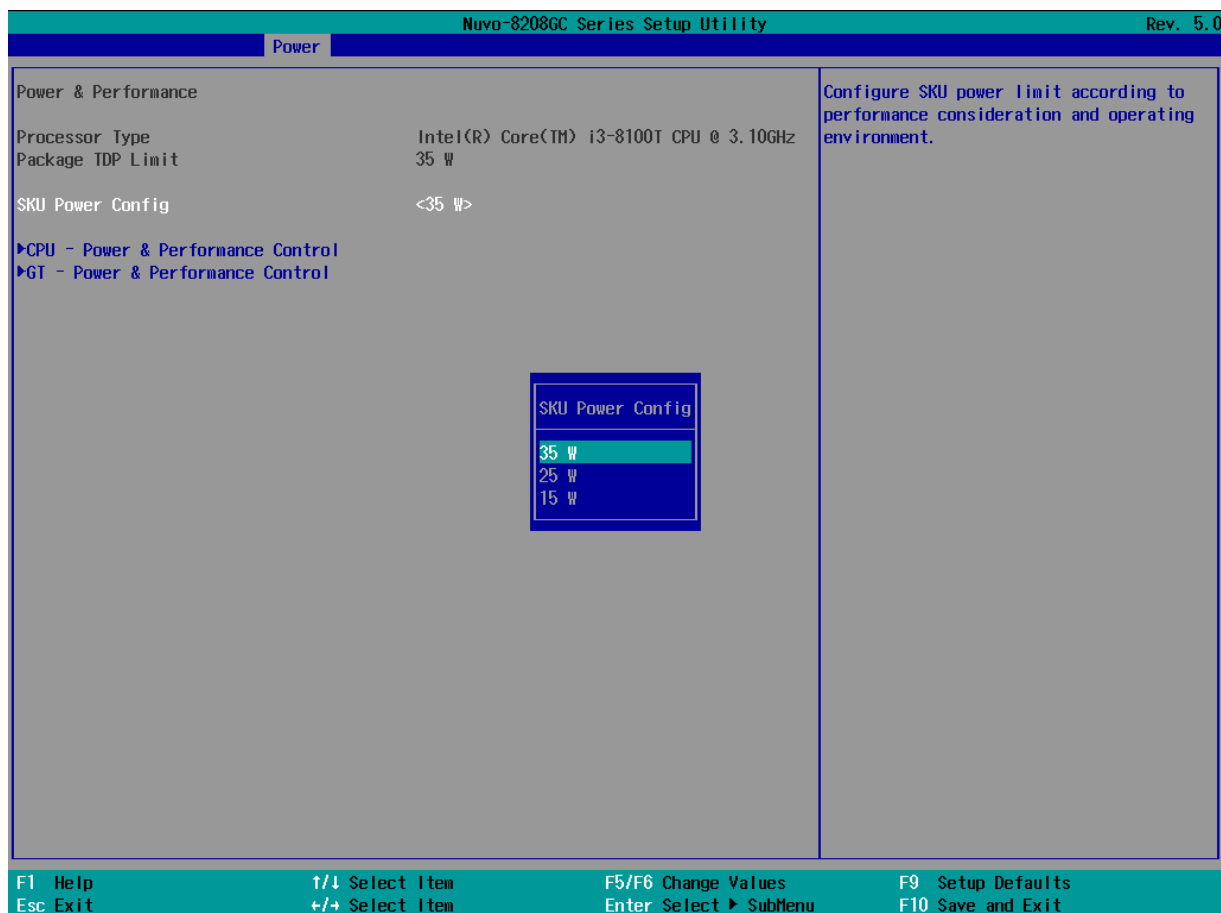

To configure the CPU SKU power limit:

1. When the system boots up, press F2 to enter BIOS setup utility.
2. Go to **[Power]** → **[Power & Performance]**.
3. Select a proper value of SKU power limit for **[SKU Power Config]** option.
4. Press F10 to "Exit Saving Changes".

4.1.10 Wake on LAN Option

Wake-on-LAN (WOL) is a mechanism which allows you to turn on your System series via Ethernet connection. To utilize Wake-on-LAN function, you have to enable this option first in BIOS settings. Please refer "[Powering On Using Wake-on-LAN](#)" to set up the system.



To enable/ disable “Wake on LAN” option:

1. When system boots up, press F2 to enter BIOS setup utility.
2. Go to **[Power]> [Wake on LAN]**.
3. Press ENTER to bring up setting options, scroll to the setting you desire and press ENTER to set.
4. Press F10 to “Exit Saving Changes.”

4.1.11 Boot Menu

The Boot menu in BIOS allows you to specify the system’s boot characteristics by setting bootable device components (boot media) and method. Or, you may press F12 upon system start up and select a device you wish boot from.

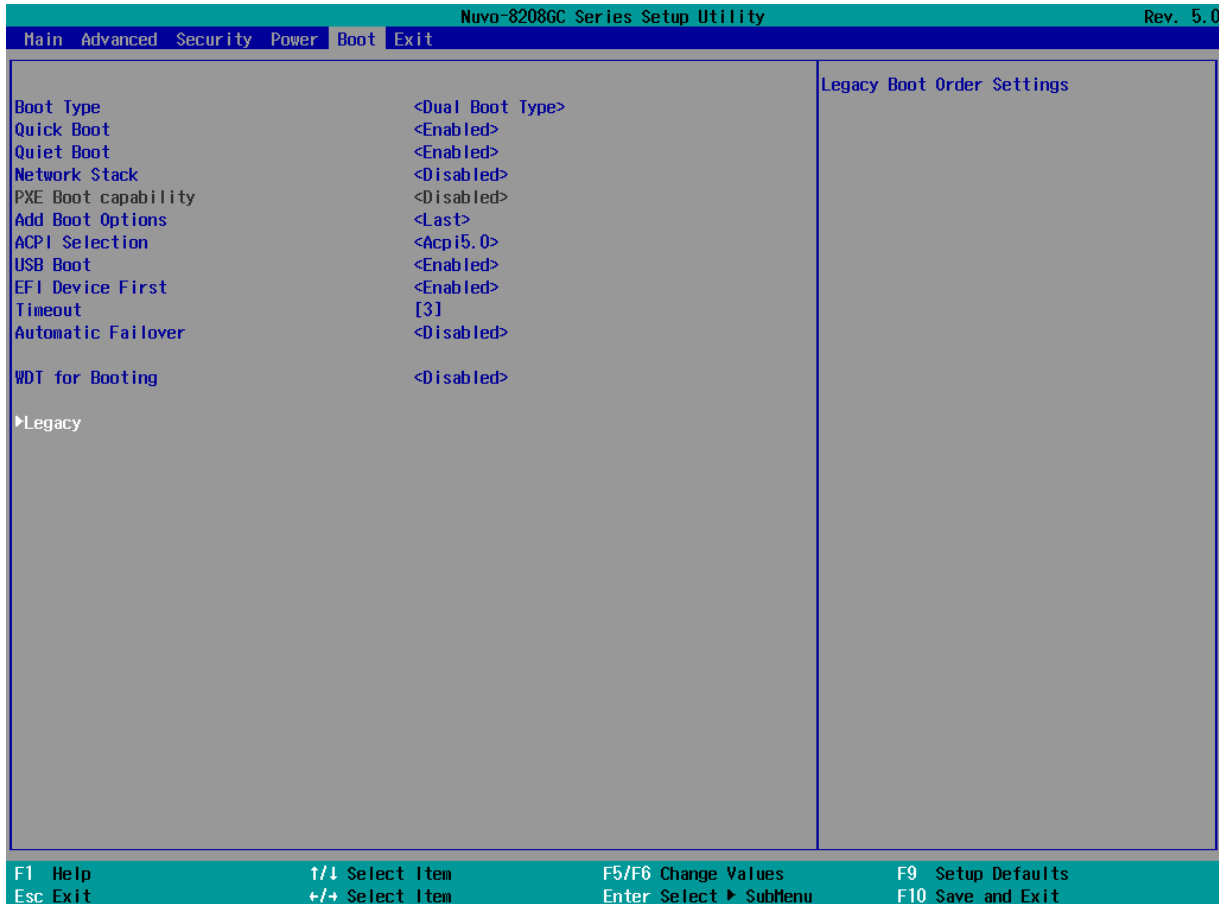



Value	Option	Description
Boot Type	Dual Boot Type	Both legacy and EFI boot media listed are approved as boot media
	Legacy Boot Type	Only legacy boot media listed are approved as boot media
	UEFI Boot Type	Only legacy boot media listed are approved as boot media
Quick Boot	Enabled	The system starts up faster because BIOS skips various hardware function tests
	Disabled	The system starts up slower because BIOS goes through various hardware functions tests
Quiet Boot	Enabled	When enabled, the BIOS will display the full-screen logo during the boot-up sequence, hiding normal POST messages
	Disabled	When disabled, the BIOS will display the normal POST messages

Network Stack	Enabled	The system is available for network access using UEFI
	Disabled	The system is not available for network access using UEFI
PXE Boot capability	Disabled	Only UEFI Network Stack is supported: Preboot eXecution Environment (PXE) is not supported
	Enabled	By enabling the PXE boot, one can choose to boot via I219 Only/ I210 Only or All NICs
Add Boot Options	First	Newly detected boot media are placed at the top of the boot order
	Last	Newly detected boot media are placed at the bottom of the boot order
ACPI Selection	1.0B/ 3.0/ 4.0/ 5.0/ 6.0	Advanced Configuration and Power Interface allows the operating system to control system power management
USB Boot	Enabled	Allow boot from bootable USB devices
	Disabled	Does not allow boot from bootable USB devices
EFI Device First	Enabled	Set to boot bootable EFI media first
	Disabled	Will not boot bootable EFI media first
Timeout	1, 2, 3, etc (in seconds)	Boot delay time in seconds to give the user time to activate the hotkey to access the BIOS
Automatic Failover	Enabled	Automatically checks for the next bootable device when the set default device fails
	Disabled	Will only boot from the designated device
WDT for booting	Disabled, 1, 3, 5, 10 (minutes)	WDT ensures a successful system boot by specifying a timeout value

4.1.12 Boot Type (Legacy/ UEFI)

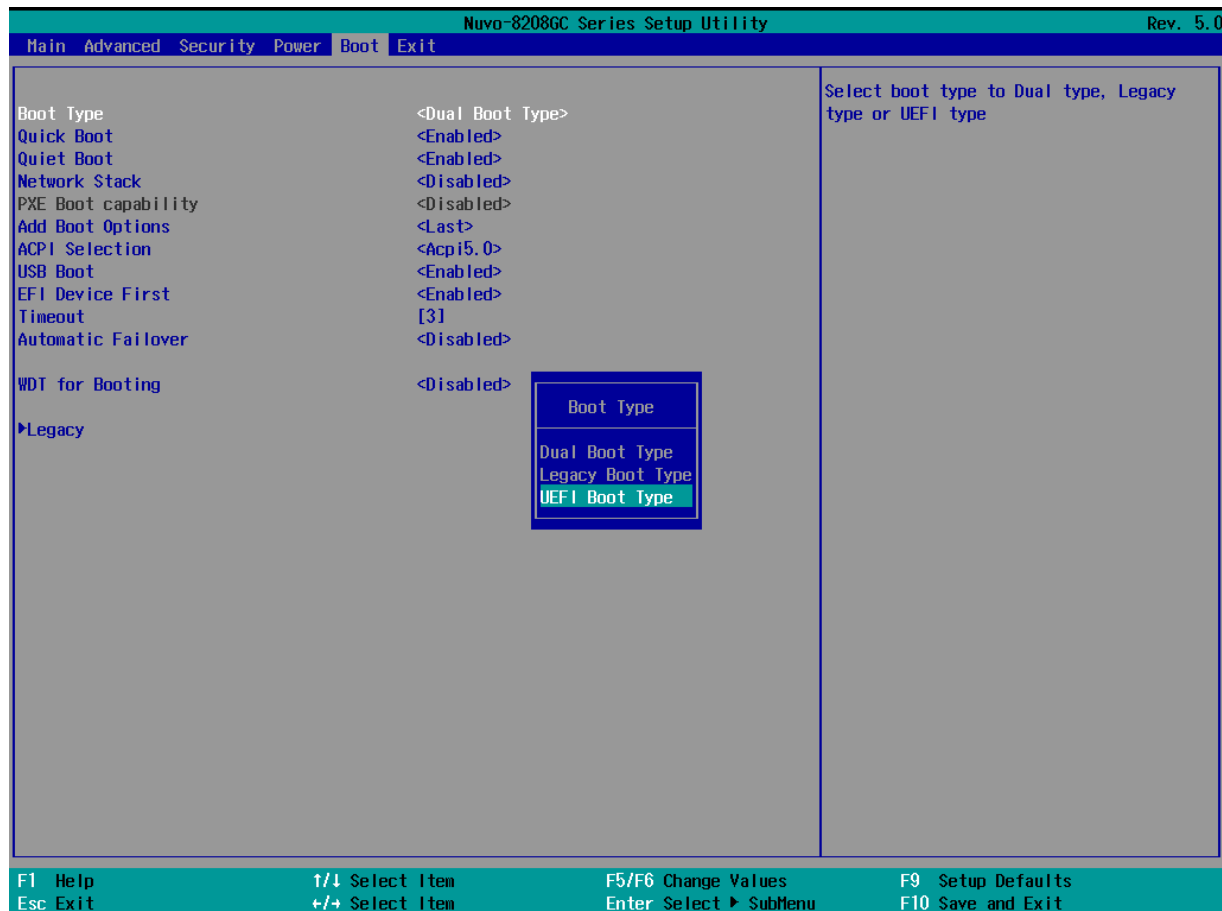
The system supports both Legacy and Unified Extensible Firmware Interface (UEFI) boot modes. UEFI is a specification proposed by Intel to define a software interface between operating system and platform firmware. Most modern operating systems, such as Windows 10 and Linux support both Legacy and UEFI boot modes. The Legacy boot mode uses MBR partition for disk and VBIOS for video initialization, the UEFI boot mode uses GPT partition which supports greater than 2TB partition size and GOP driver for faster video initialization.



 **NOTE**

If you choose Legacy mode, you will not be able to create disk partitions greater than 2TB or use TPM 2.0 function.

To configure Boot Type:

1. When system boots up, press F2 to enter BIOS setup utility.
2. Go to **[Boot]>[Boot Type]**, press Enter to bring up options, Dual Boot (Legacy+UEFI), Legacy Boot Type, UEFI Boot Type.
3. Highlight your selection and press Enter.
4. Press F10 to “Exit Saving Changes”.

4.1.13 Position New Boot Device

The “Add Boot Options” allow you to determine whether a newly added device (eg. USB flash disk) is to boot as the first device to boot or the last in the boot sequence.

To set the newly-installed boot device as the first or last boot device:

1. Press **F2** when the system boots up to enter the BIOS setup utility.
2. Go to **[Boot] > [Add Boot Options]** menu.
3. Select **[First]** or **[Last]** for your newly-added boot device and press ENTER.

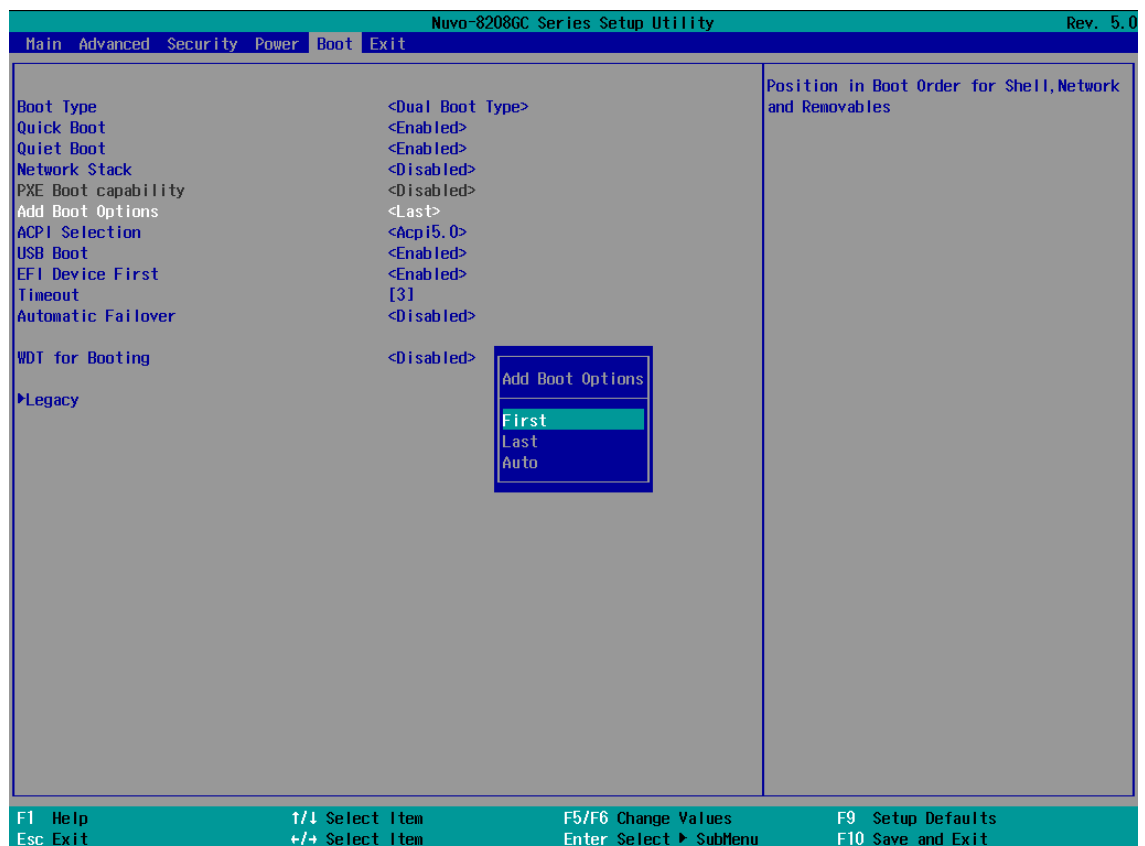

4. Once set, press **F10** to save setting and exit.

4.1.14 Watchdog Timer for Booting

The watchdog timer secures the boot process by means of a timer. Once the timer expires, a reset command is issued to initiate another booting process. There are two options in BIOS menu, “*Automatically after POST*” and “*Manually after Entering OS*”. When “*Automatically after POST*” is selected, the BIOS automatically stops the watchdog timer after POST (Power-On Self Test) OK. When “*Manually after Entering OS*” is selected, the user must stop the watchdog timer once booted into the OS. This guarantees the system can always boot into the OS, otherwise another booting process will be initiated. For information about programming watchdog timer, please refer to [Watchdog Timer & Isolated DIO](#).

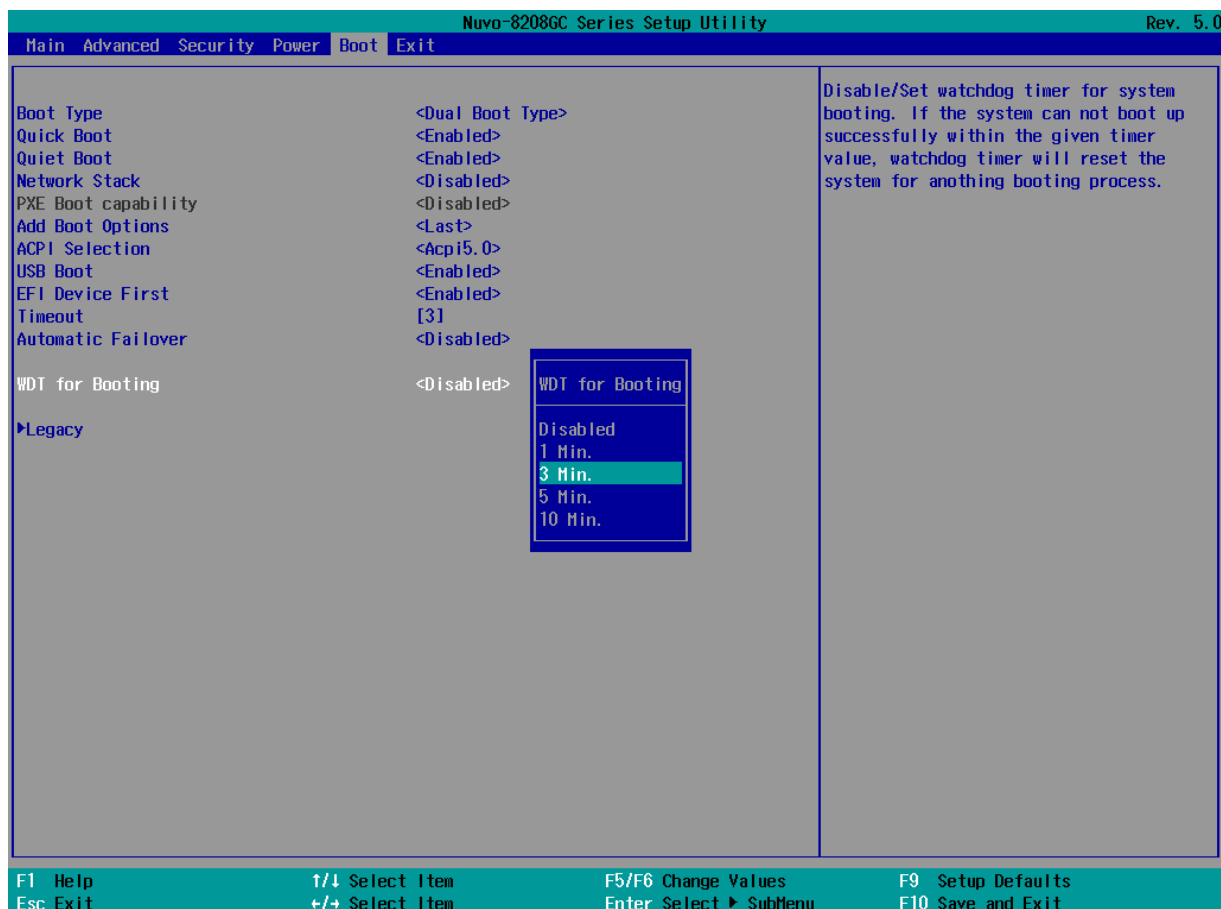

To set the watchdog timer for boot in BIOS:

1. When system boots up, press F2 to enter BIOS setup utility.
2. Go to **[Boot]** menu.
3. Disable or select timeout value for **[WDT for Booting]** option.
4. Once you give a timeout value, the **[WDT Stop Option]** option appears. You can select “*Automatically after POST*” or “*Manually after Entering OS*”.
5. Press F10 to “Exit Saving Changes.

4.1.15 Legacy/ UEFI Boot Device

When you wish to set a designated boot device, you may set it as the first device to boot in Legacy or UEFI Boot Device setting. Or if you wish to manually select a boot device, you may do so by pressing F12 when the system boots up.

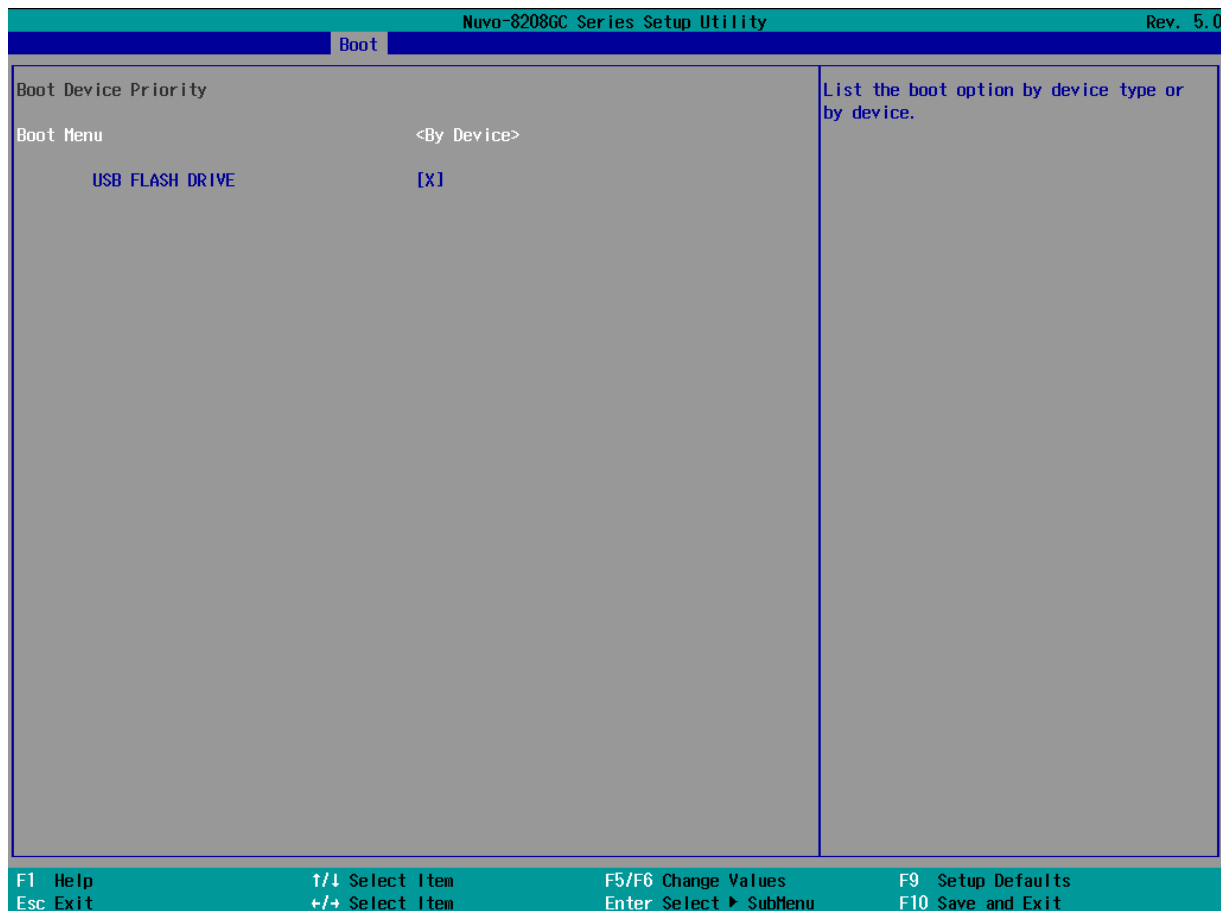

To set boot order for devices in UEFI Boot Device:

1. When system boots up, press F2 to enter BIOS setup utility
2. Go to **[Boot] > [UEFI Boot Device]**
3. Highlight the device you wish to make boot order changes to and press F5/ F6 or +/- to change device boot order.

To select boot order for devices in Legacy Boot Device:

1. When system boots up, press F2 to enter BIOS setup utility
2. Go to **[Boot] > [Legacy Boot Device]**, you can choose the type of device to list by selecting "By Device or By Device Type".
3. Highlight the device you wish to make boot order changes to and press F5/ F6 or +/- to change device boot order.

4.2 AMT Configuration

Intel® AMT (Active Management Technology) is a hardware-based technology for remotely managing target PCs via Ethernet connection. The system supports AMT function via its Ethernet port implemented with Intel I219-LM. Prior to using the AMT function to remotely control the system, you need to configure AMT password and network settings.

1. Connect Ethernet cable to I219-LM Ethernet port (indicated in blue).

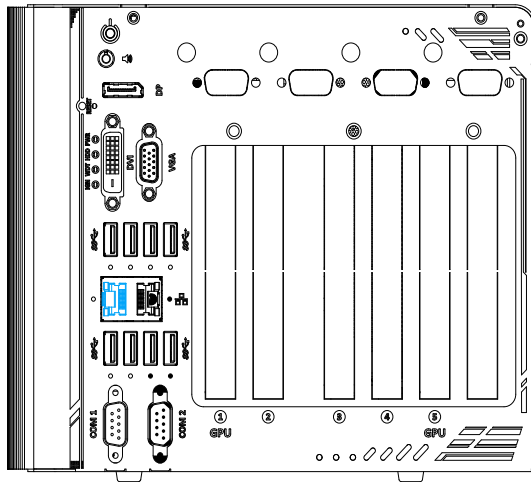

2. When the system boots up, press F10 to enter the MEBx configuration menu.

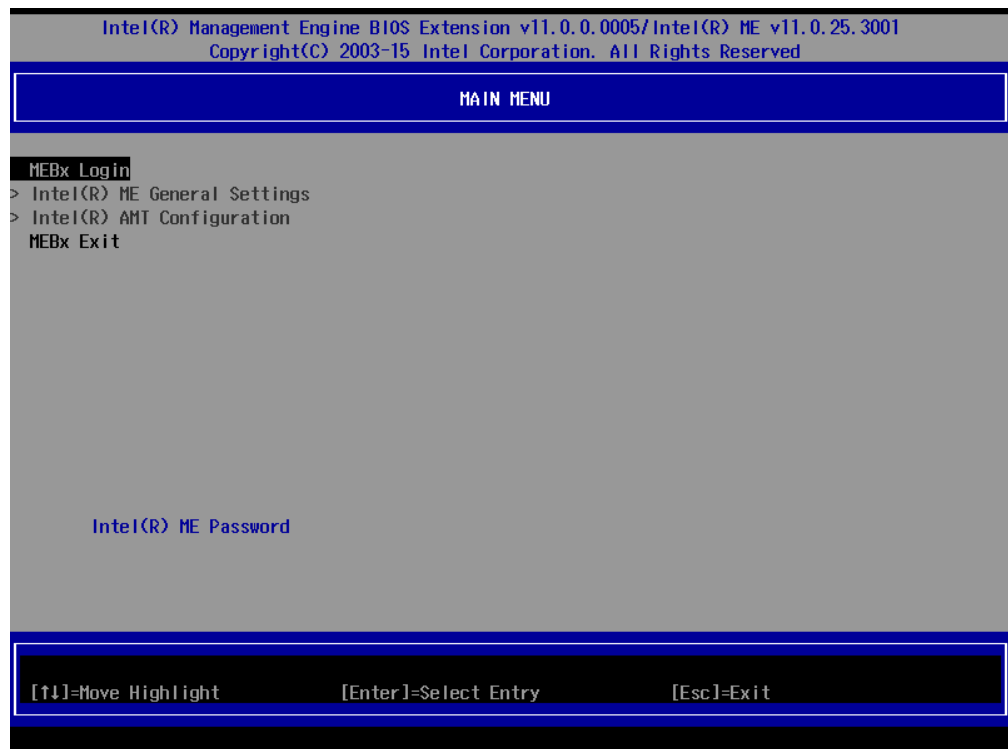

3. Highlight MEBx Login and press Enter, a prompt will appear asking for password. The default password is "admin". For further MEBx configuration details, please refer to [Intel® MEBX User Guide](#).

4.3 RAID Configuration

To set up a RAID 0 or 1 volume in Legacy or UEFI mode, you need to have at least two hard drives or SSDs installed. The system supports RAID configurations in RAID 0 (striping) or RAID 1 (mirror) mode. Users can select the configuration that best suit their needs with RAID 0 (striping) mode offering better hard drive read/ write performances while RAID 1 (mirror) offers better data security.



WARNING

Please back up hard drive data before you create or modify RAID volume(s) as the process may cause irreversible data deletion. When creating a RAID volume, it is also recommended to use hard drives from the same batch (same brand, model, capacity, rpm rate, etc.) to avoid performance or capacity allocation issues.

4.3.1 Legacy Mode RAID Configuration

To set up RAID configuration, you need to pre-configure the SATA mode setting in the BIOS. Please refer to the following steps:

1. When system boots up, press **F2** to enter BIOS setup utility.
2. Go to **[Advanced] > [SATA And RST Configuration] > [SATA Mode Selection]** > highlight **[Intel RST Premium With Intel Optane System Acceleration]** and press ENTER.



- Go to [Boot] > highlight [**Legacy Boot Type**] and press ENTER to set boot type.

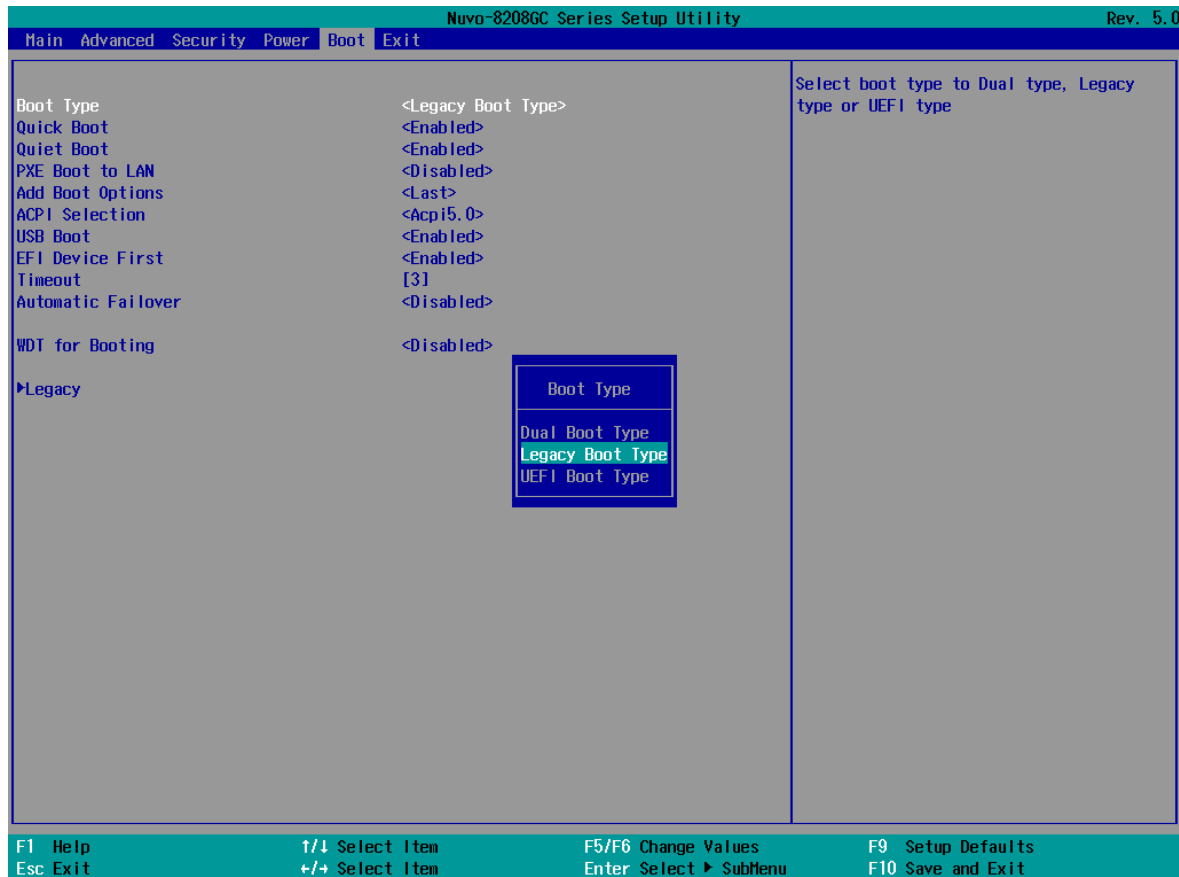

- Press F10 to "Exit Saving Changes" and reboot the system.
- When the system reboots, press [**Ctrl + I**] to enter the RAID configuration utility.
- Once you're in the Configuration Utility, highlight [**Create RAID Volume**] and press ENTER.



7. The following screen allows you to enter the **Name** of the RAID volume you wish to create. Enter a name and press ENTER to access the **RAID Level** setting.

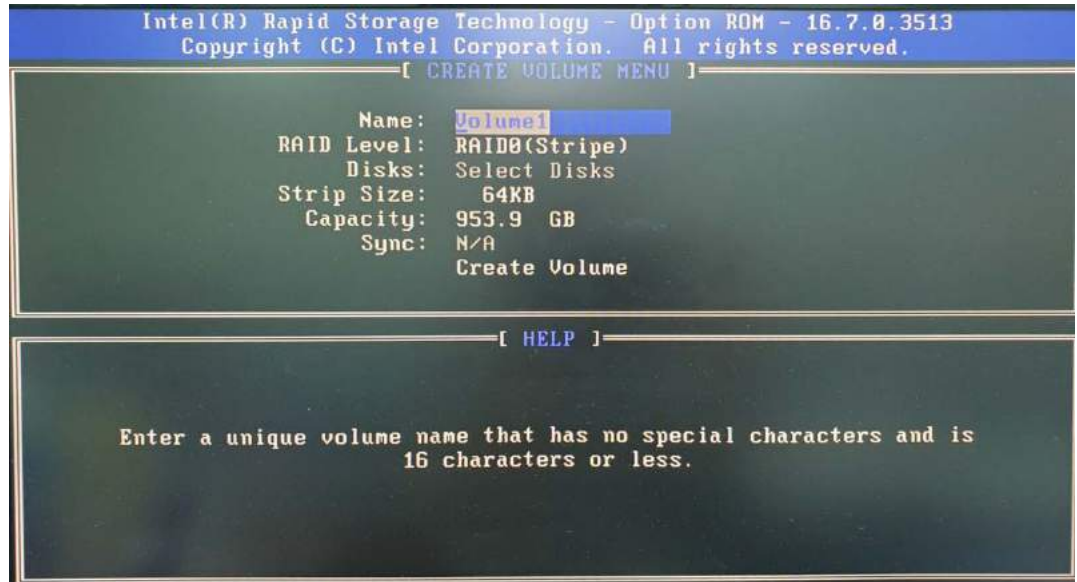

8. For **RAID Level**, use the up and down arrow key to select between **RAID0 (Stripe)** or **RAID1 (Mirror)** settings. Select a RAID mode and press ENTER to access **Stripe Size** setting (not applicable to Mirror mode).

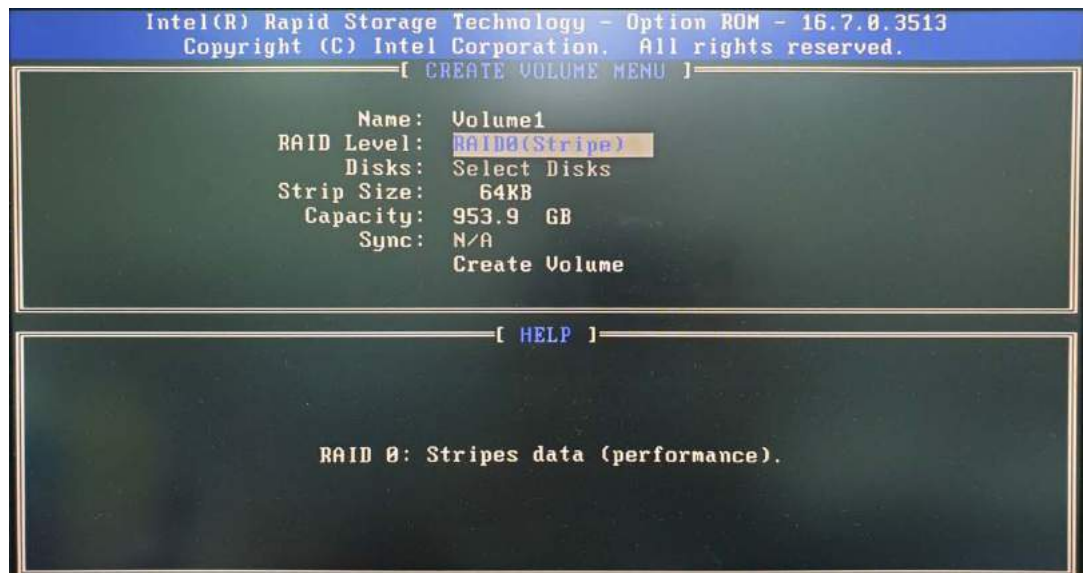

- For **Stripe Size**, use the up and down arrow key to select between 4KB, 8KB, 16KB, 32KB, 64KB, 128KB for your RAID volume stripe size and press ENTER to access the **Capacity** setting.

*RAID1(Mirror) does not offer Stripe Size options.

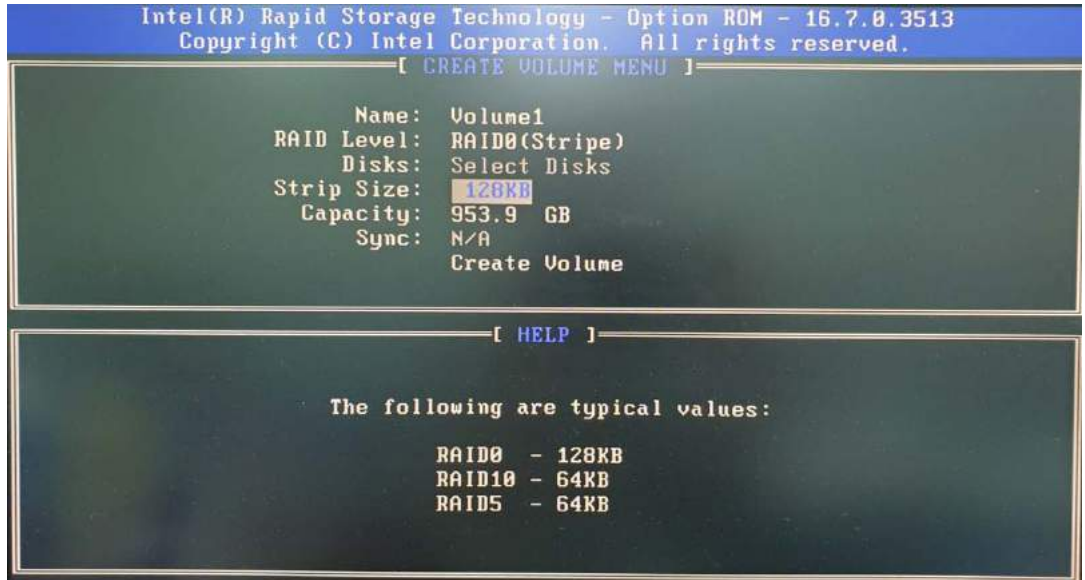

- You may enter the RAID volume capacity you wish to create at this step and press the Enter key to complete your RAID settings. By default, the maximum capacity will be applied. Once you have entered a capacity, press ENTER to confirm.

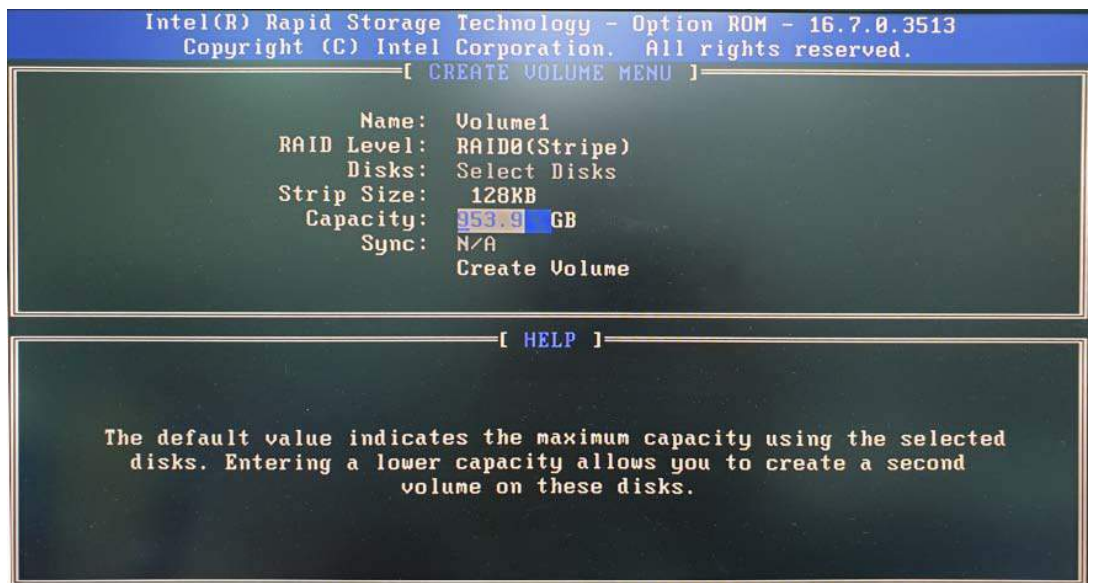

11. Reviewed your settings and if you wish to change any setting(s), you will need to press [ESC] and start again from **Step 5**. If all settings are correct and you wish to continue, with **“Create Volume”** highlighted, press ENTER to begin creating the RAID volume.

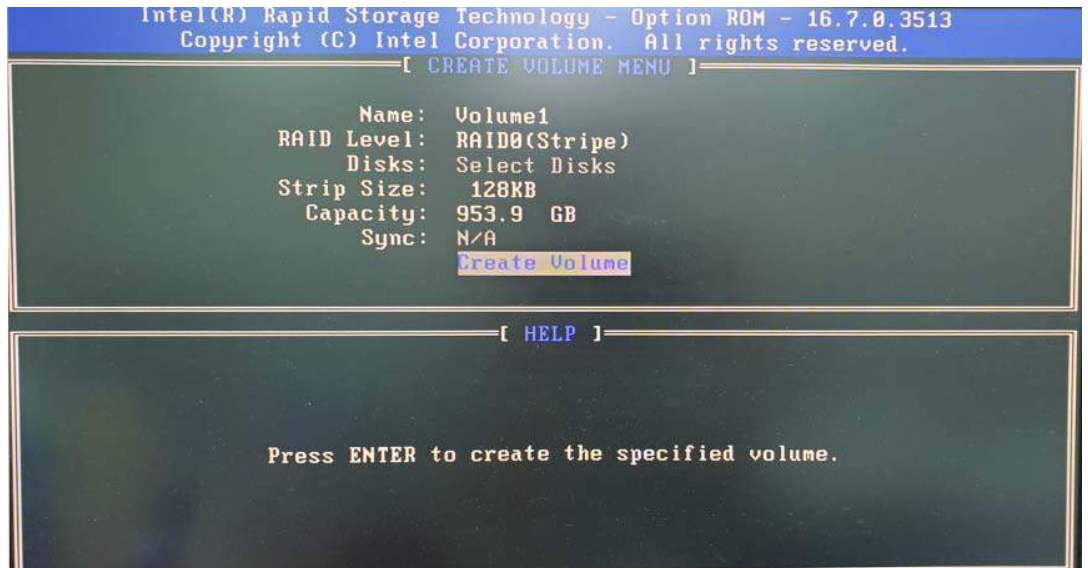

12. A data deletion warning will appear, enter “Y” to continue and “N” to stop the volume creation process.

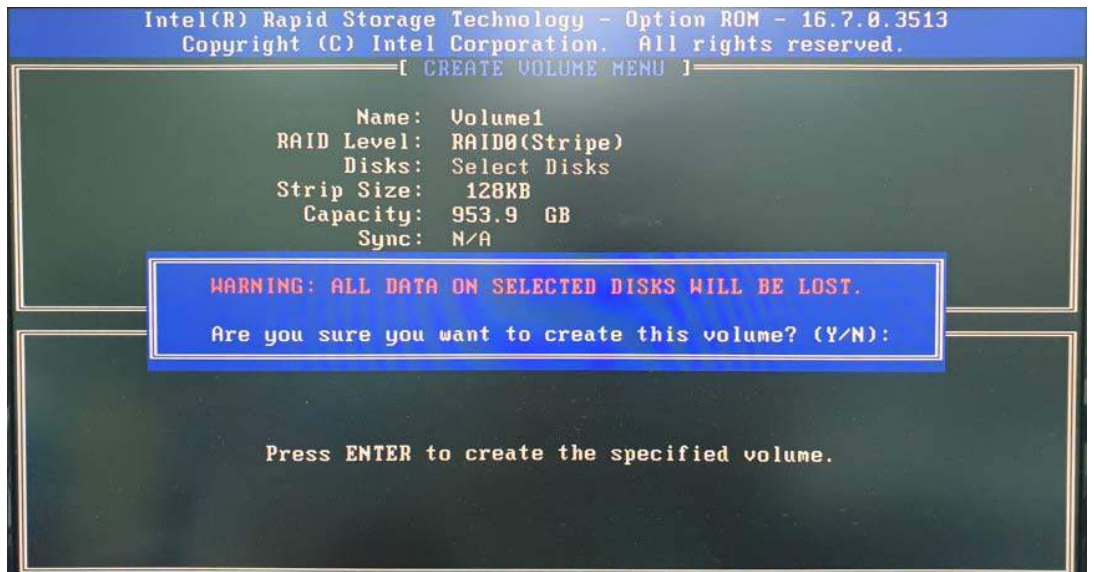

13. Once the RAID volume has been created, the configuration utility will bring you back to the main screen showing the RAID volume and their member disks.

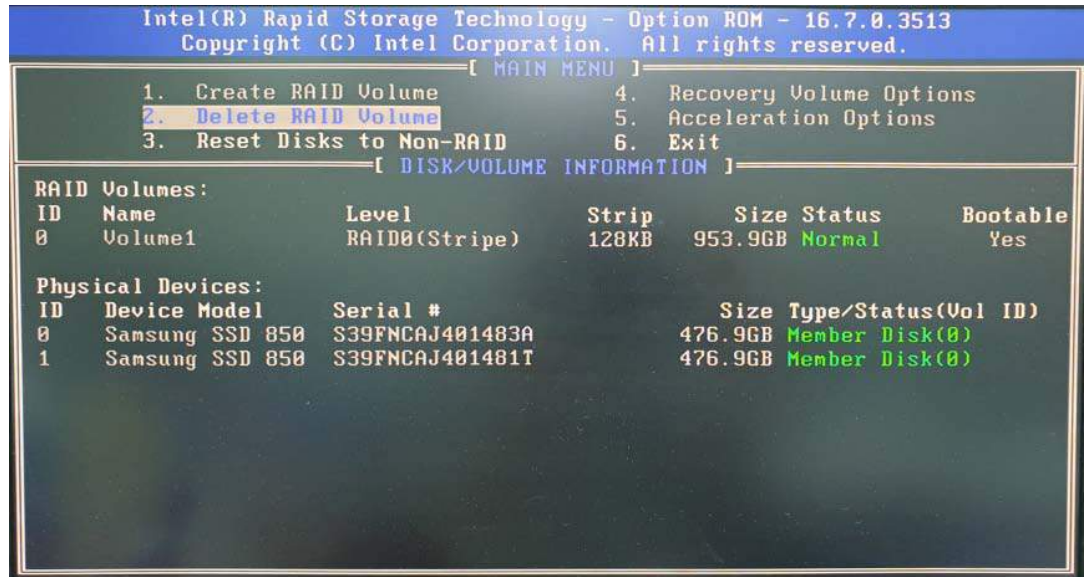

14. The above process was to create a RAID-0 volume. If you wish to create a RAID-1 volume, please perform steps 5 to 13 in this section and select RAID-1 during step 8.

4.3.2 UEFI Mode RAID Configuration

To enable RAID functionality in UEFI mode:

1. When system boots up, press F2 to enter BIOS setup utility.
2. Go to **[Advanced] > [SATA And RST Configuration] > [SATA Mode Selection] > highlight [Intel RST Premium With Intel Optane System Acceleration]** and press ENTER.

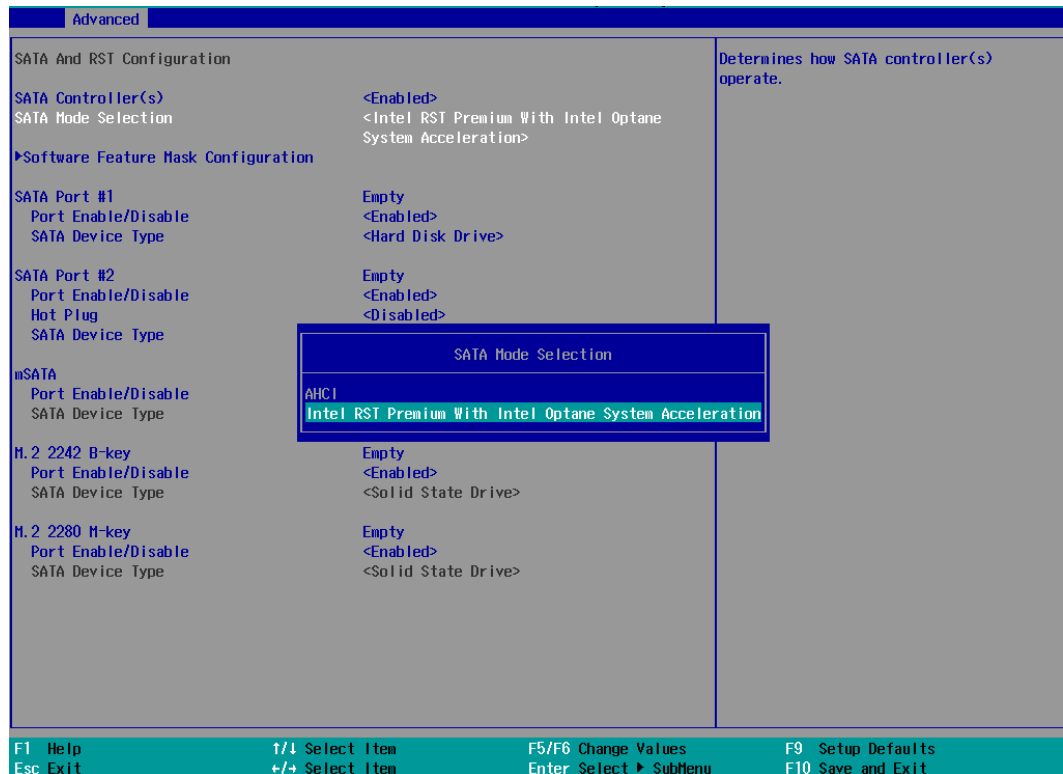

- Go to **[Boot]**, highlight **[UEFI Boot Type]** and press ENTER to set boot type.

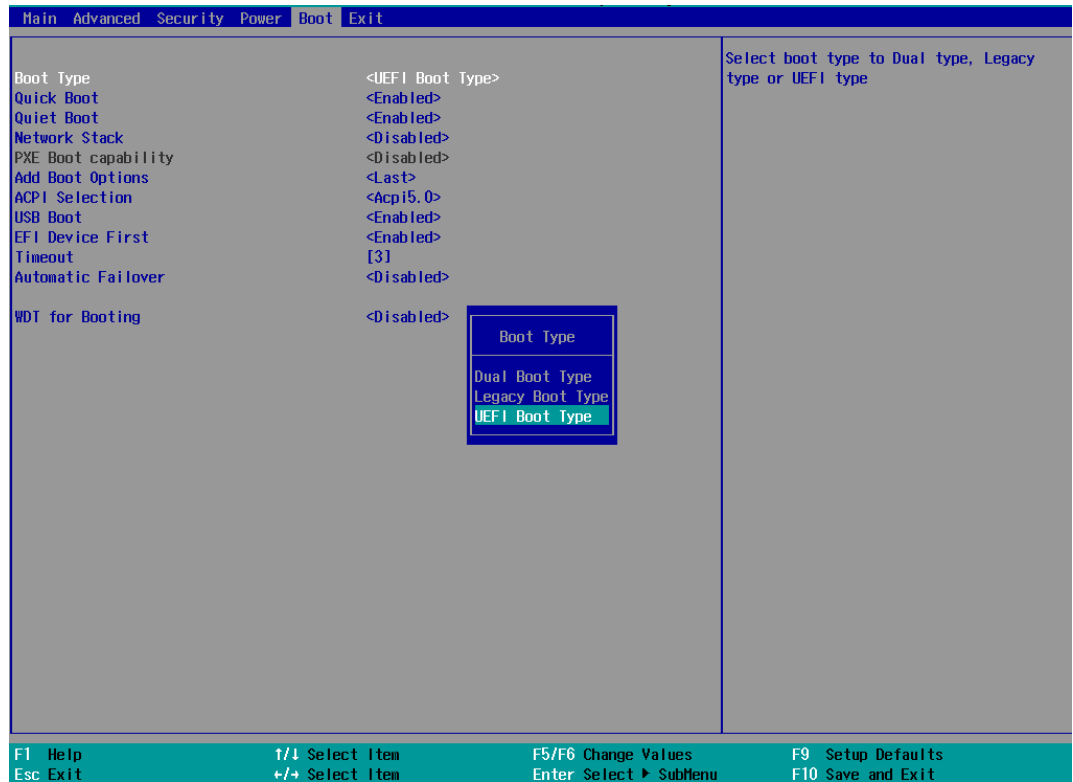

- Press F10 to “Exit Saving Changes” and reboot the system.
- When the system reboots, press **[F3]** to enter the Configuration Utility.
- Once you’re in the Configuration Utility, highlight **[Intel® Rapid Storage Technology]** and press ENTER.



- The following screen shows Non-RAID physical disks and the option “**Create RAID Volume**”. Highlight “**Create RAID Volume**” and press ENTER to begin creating your RAID volume.

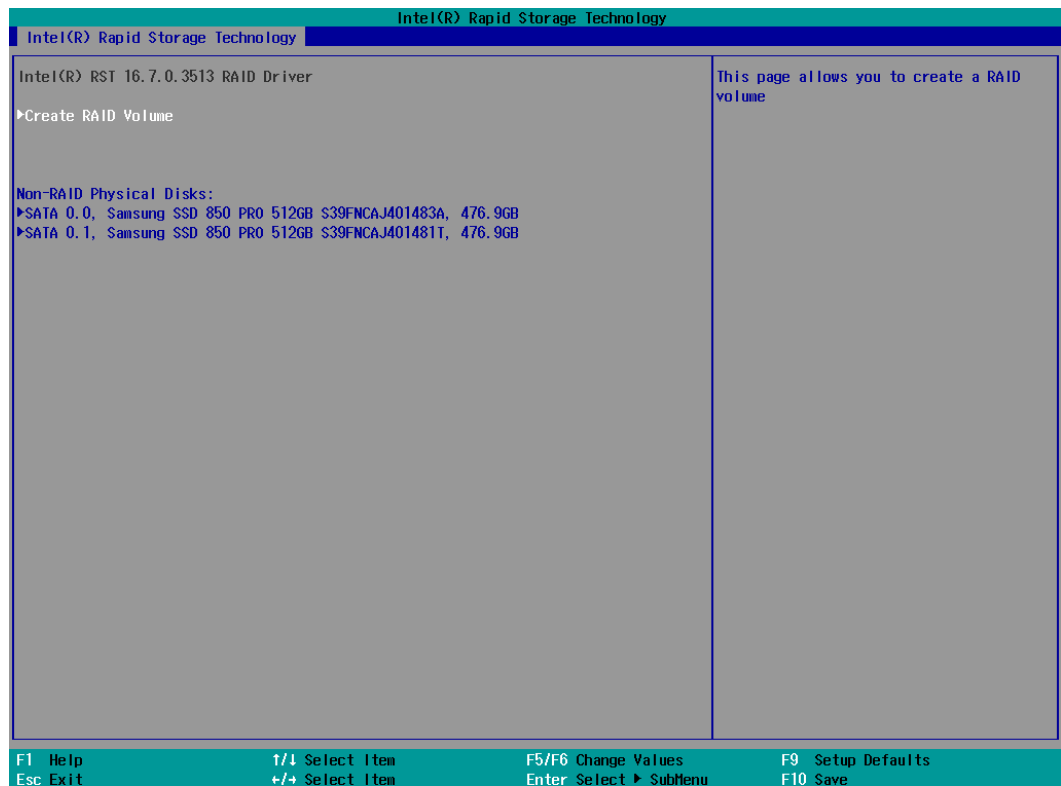

8. The Name option allows you to name your RAID volume. Press ENTER when ready to go to the next option.

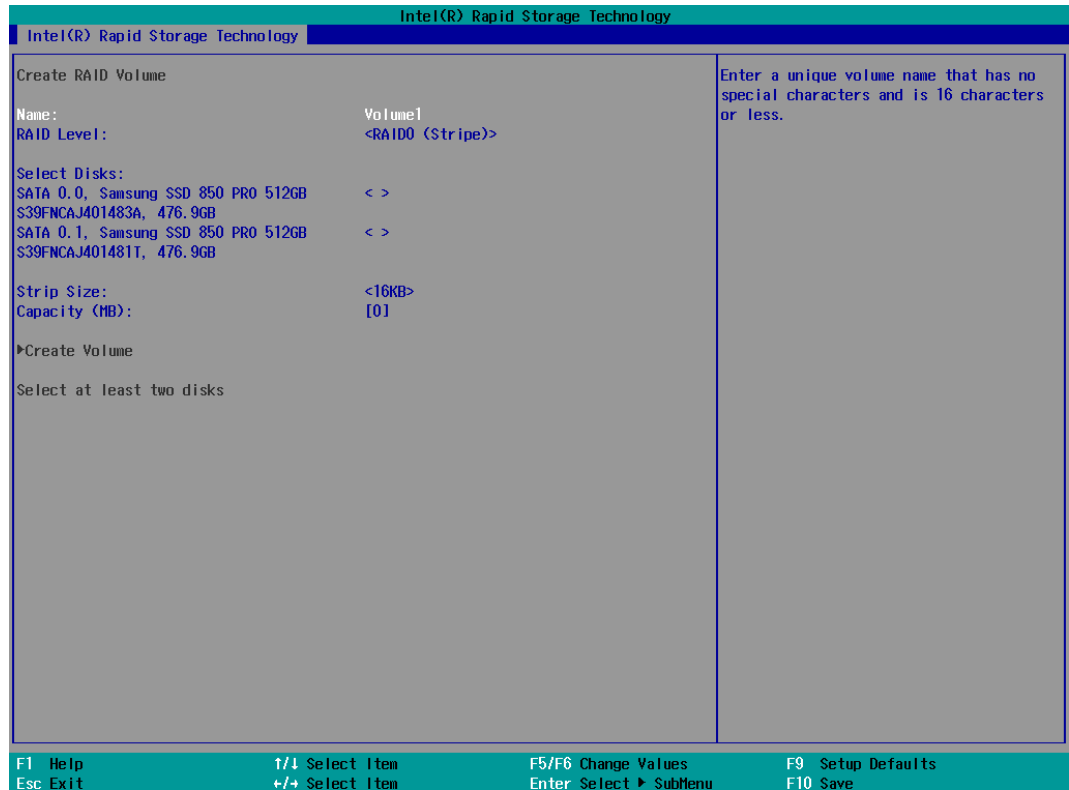

9. The RAID Level option allows you to select RAID-0 (striping) or RAID-1 (mirror) for your RAID volume. Press ENTER when ready.



- The Select Disks option allows you to select disk drives for your RAID volume. Highlight a drive and press ENTER, use up/ down arrow keys to highlight "x" and press ENTER to confirm the selection. A minimum of two disk drives must be selected for RAID-0 or RAID-1 configuration. Press ENTER when ready.

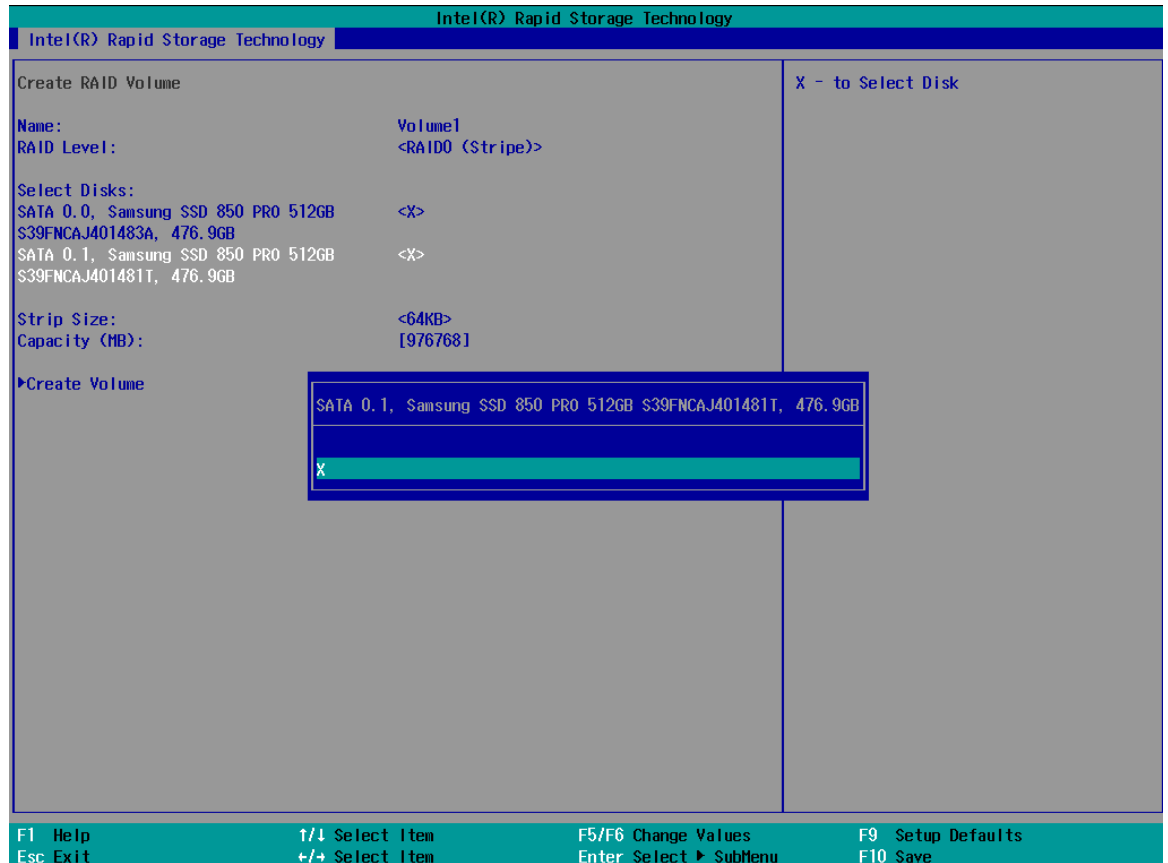

11. The Stripe Size option allows you to configure the stripe size of your RAID volume. Available stripe sizes are 4KB, 8KB, 16KB, 32KB, 64KB, 128KB, use the up and down arrow keys to highlight and press ENTER to confirm the stripe size selection.

*RAID1(Mirror) does not offer Stripe Size options.

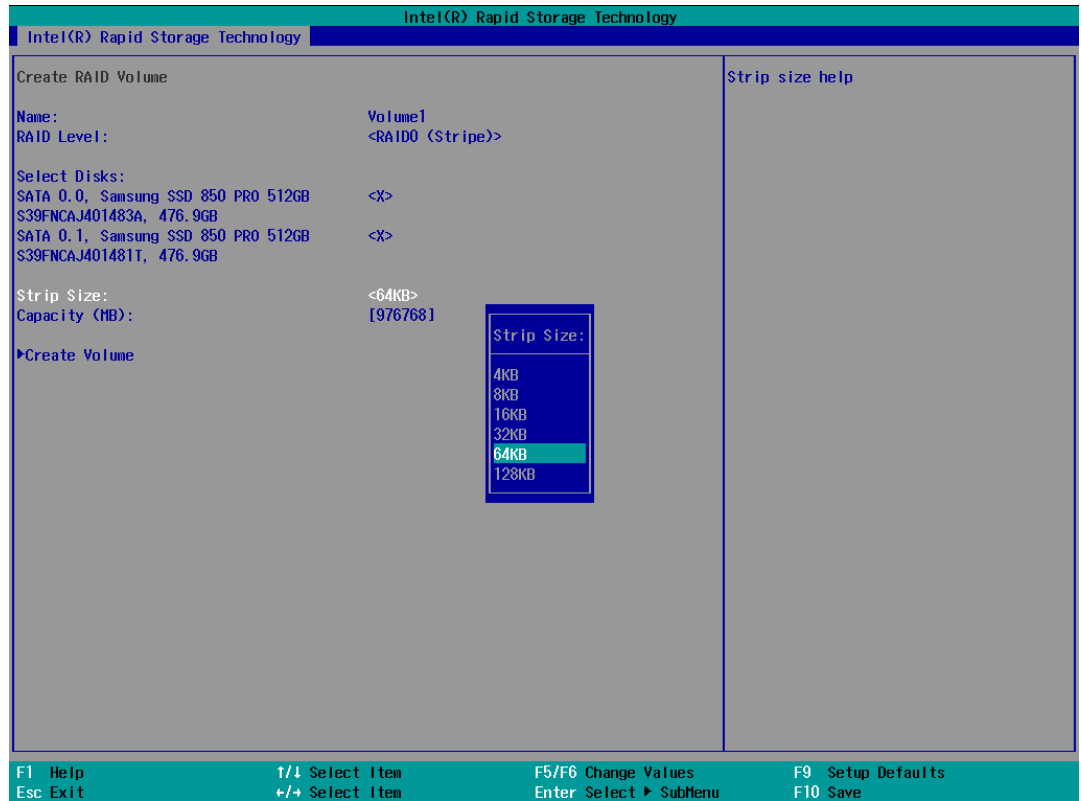

- The Capacity (MB) option allows you to configure the storage capacity of your RAID volume. By default, the full storage capacity will be applied. Once you have entered a capacity, press ENTER to confirm.



- The Create Volume option is the final step in the volume creation process. Highlight **“Create Volume”** and press ENTER to begin creating your RAID volume base on the settings you just configured.

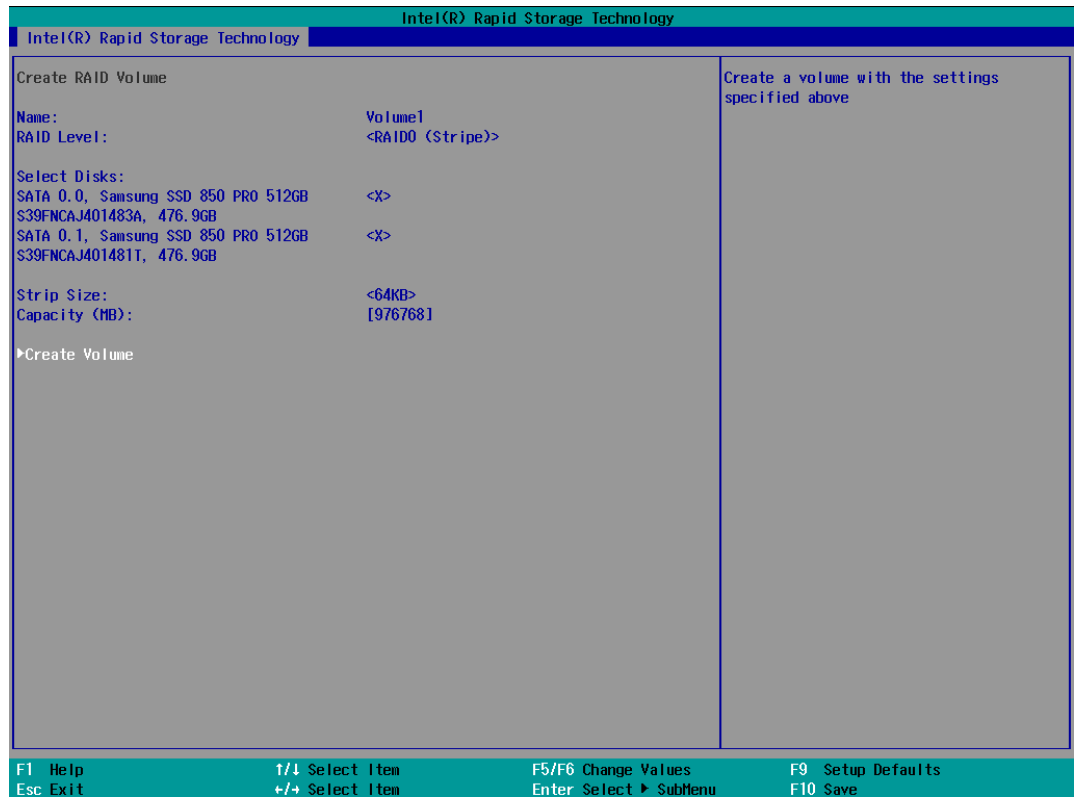

- A summary and status of the RAID volume will be shown when the RAID volume is successfully created.

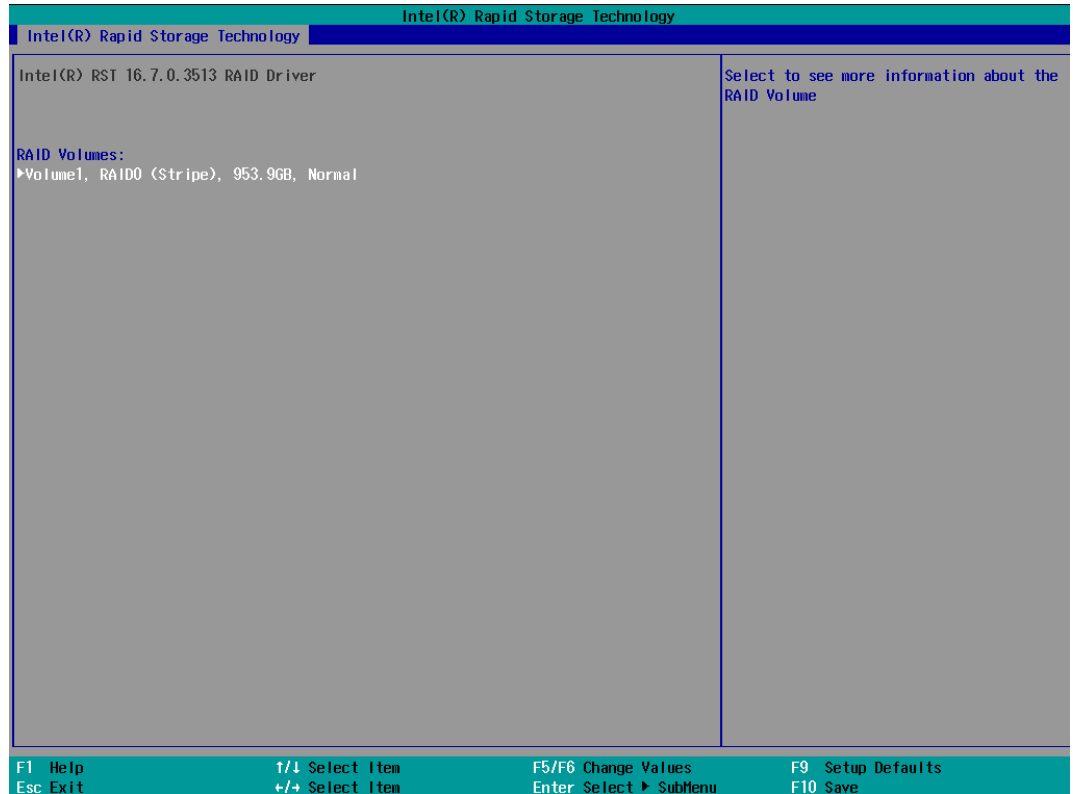

- Press F10 to save and Esc to exit the Intel® Rapid Storage Technology configuration page.



NOTE

The above process was to create a RAID-0 volume. If you wish to create a RAID-1 volume, please perform steps 5 to 13 in this section and select RAID-1 during step 9.

5 OS Support and Driver Installation

5.1 Operating System Compatibility

The system supports most operating system developed for Intel® x86 architecture. The following list contains the operating systems which have been tested by Neousys Technology.

- Microsoft Window 10 (x64)
- Fedora 29**
- Ubuntu 16.04.5 LTS** & Ubuntu18.04.0 LTS**



NOTE

For other Linux OS, Linux kernel should upgrade to 4.15.18.

**For Linux system, user may need to manually compile and install the driver for Intel graphics or I210 GbE controller if the driver is not embedded in kernel. You can visit Intel website for further information.*

***For distributions, graphics driver and RAID function may not be completely implemented in its kernel. You may encounter restrictions when using these features, such as triple independent display and RAID. For optimum operation, it is the users' responsibility to manually check for new drivers and upgrades!*

Neousys may remove or update operating system compatibility without prior notice. Please contact us if your operating system of choice is not on the list.

5.2 Driver Installation

The system comes with a “Drivers & Utilities” DVD that offers “one-click” driver installation process or you can choose to install driver manually.

5.2.1 Install Drivers Automatically

The system comes with a “Drivers & Utilities” DVD that offers “one-click” driver installation process. It automatically detects your Windows operating system and installs all necessary drivers for you system with a single click.

To install drivers automatically, please refer to the following procedures.

1. Insert the “Drivers & Utilities” DVD into a USB DVD-drive connect to your system. A setup utility launches and the following dialog appears.



2. Click on “**Automatic Driver Installation**” and the setup utility will automatically detect your Windows operating system and install all necessary drivers. The installation process takes about 6~8 minutes depending on your Windows version. Once driver installation is done, the setup utility reboots your Windows and you may begin using your system.

5.2.2 Install Drivers Manually

You can also manually install each driver for the system. Please note when installing drivers manually, you need to install the drivers in the following sequence mentioned below.

Windows 10 (x64)

The recommended driver installation sequence is

1. Chipset driver (x:\Driver_Pool\Chipset_10_APL\Win_ALL\SetupChipset.exe)
2. Graphics driver (x:\Driver_Pool\Graphics_SKL_APL\Win_7_8_10_APL_64\Setup.exe)
3. Audio driver (x:\Driver_Pool\Audio_ALC262\Win_ALL_64\Setup.exe)
4. LAN driver
(x:\Driver_Pool\GbE_I210_I350\Win_ALL_64\APPS\PROSETDX\Win10_x64\DxSetup.exe)
5. ME driver (x:\Driver_Pool\ME_10_Series\Win_ALL_AMT\SetupME.exe)

5.3 Driver Installation for Watchdog Timer Control

Neosys provides a driver package which contain function APIs for Watchdog Timer control function. You should install the driver package (WDT_DIO_Setup.exe) in prior to use these functions. Please note that you must install WDT_DIO_Setup_v2.2.9.x or later versions.

Windows 10 (x64)

Please execute the driver setup program in the following directory.

x:\Driver_Pool\WDT_DIO\Win7_8_64\WDT_DIO_Setup_v2.2.9.x(x64).exe

Windows 10 (WOW64)

Please execute the driver setup program in the following directory.

x:\Driver_Pool\WDT_DIO\Win7_8_WOW64\WDT_DIO_Setup_v2.2.9.x(wow64).exe

5.4 Intel® Optane™ Memory BIOS Setup and Driver

Installation

The system is compatible with Intel® Rapid Storage Technology that supports the installation of Intel® Optane™ memory to significantly boost traditional hard disk drive read and write performances. Intel® Optane™ memory is Intel® RST's latest system acceleration solution featuring a dual-media/disk combination (ultrafast media for file and block caching + slow media for storage capacity) that is presented to the host OS as a single SSD. The ultrafast media utilizes PCIe NVMe SSDs that are based on Intel® Optane™ technology with read speed of up to 3000Mb/ sec and write speed of up to 2000Mb/ sec.

To setup Intel® Optane™ memory, please perform the following steps:

1. Press the power button to startup your system (please restart if your system is already up and running) and press F2 to enter BIOS.
2. Go to "Advanced > SATA And RST Configuration".

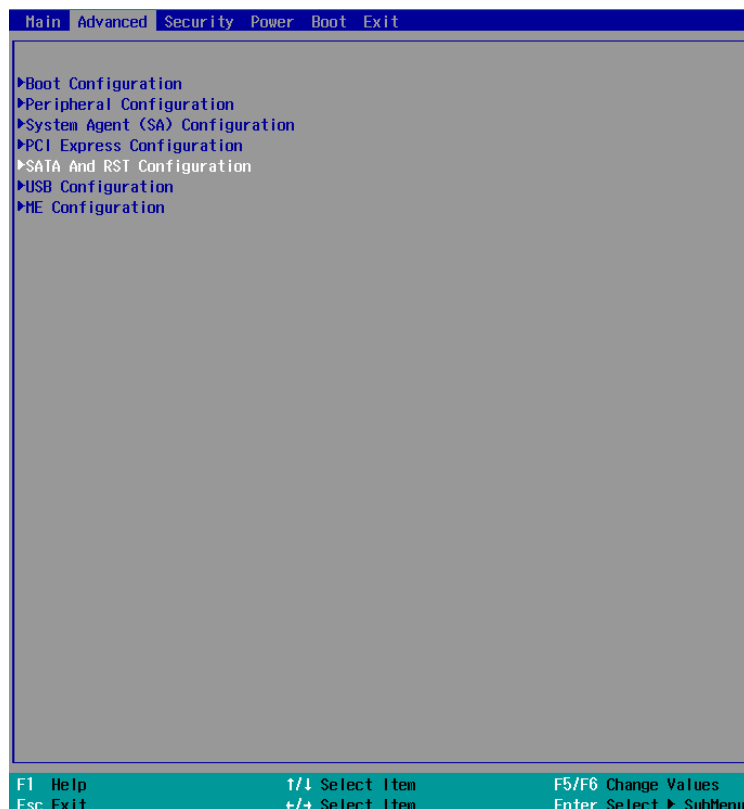

- Go to "SATA Mode Selection", press the Enter key to bring up options, select "Intel RST Premium With Intel Optane System Acceleration" and press ENTER to select the option.

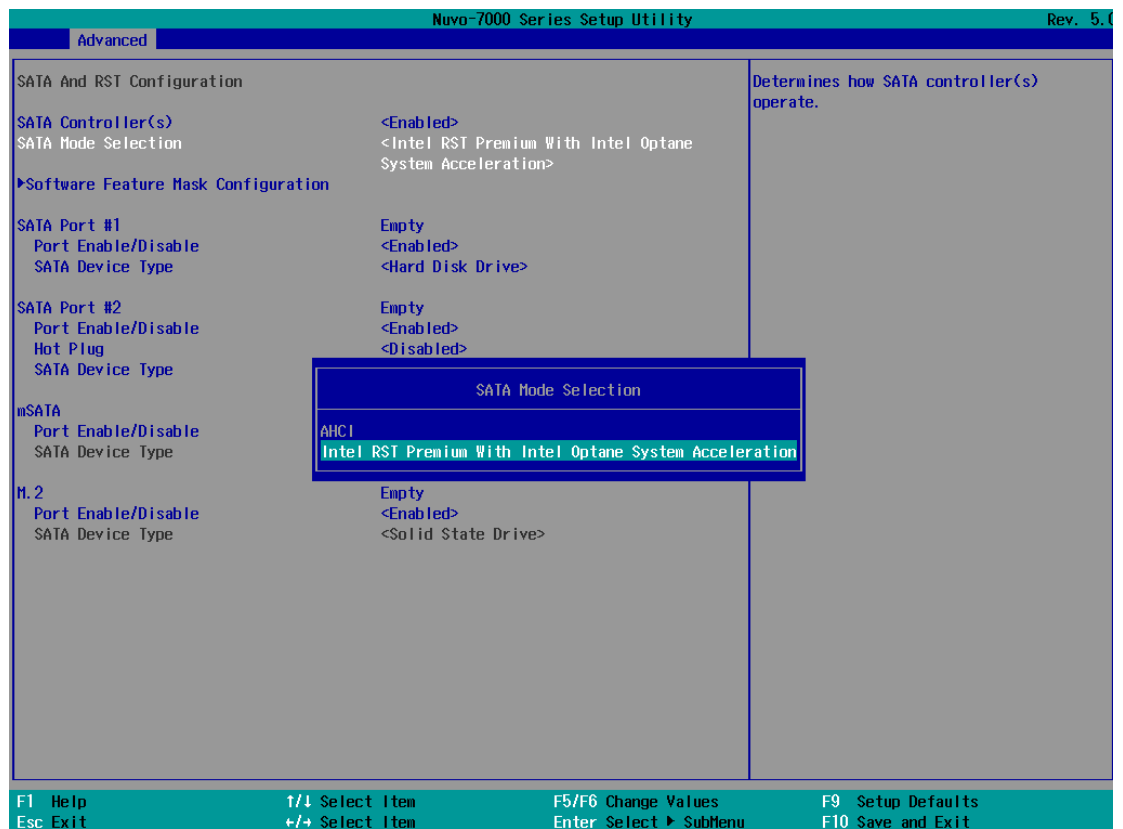

- Go to “M.2 2280 NVMe Storage Device” and press the Enter key to bring up the selection, select “RST Controlled” and press the Enter key to select the option.



- Press F10 to save and exit, and allow the system to boot into Windows.
- In Windows, download [Intel® RST driver](#) if you don't already have it on hand. Right-click



on the SetupOptaneMemory.exe and left-click on “Run as administrator” to execute the setup file.

7. Follow the 6 step setup procedure as instructed.

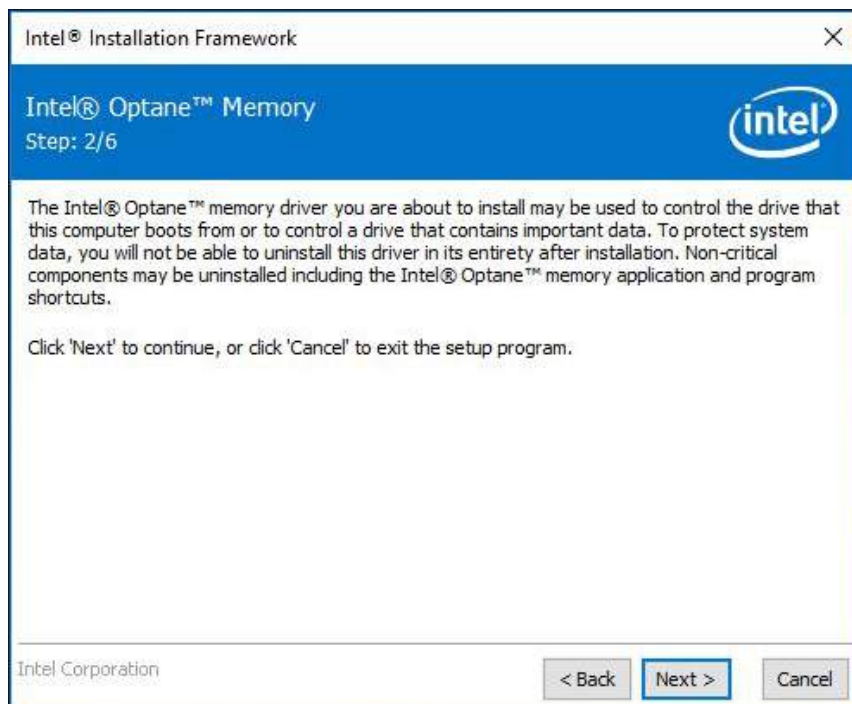
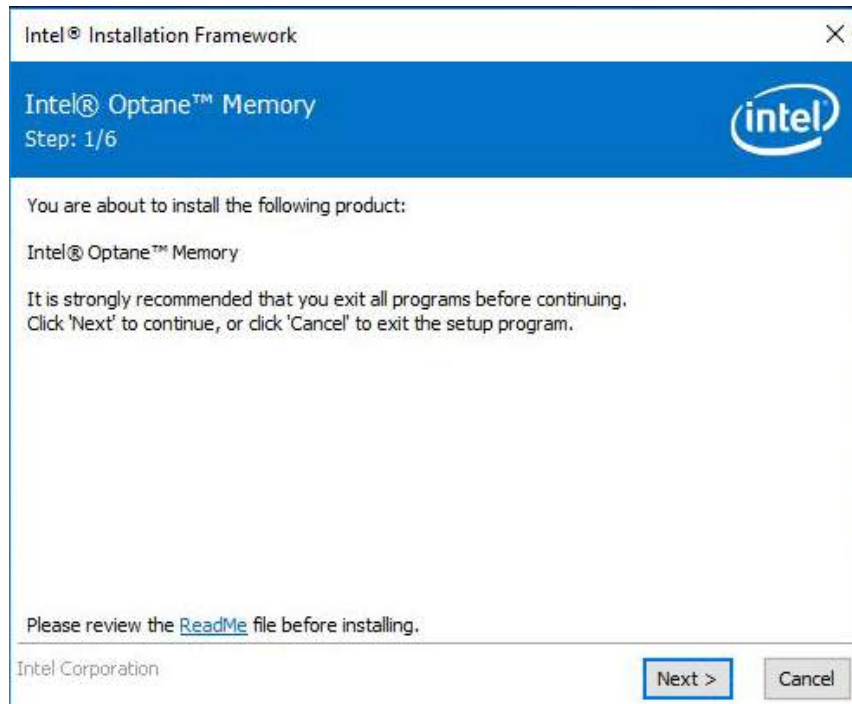

8. Check the "I accept the terms in the License Agreement" box and click on "Next >" to continue the installation process.

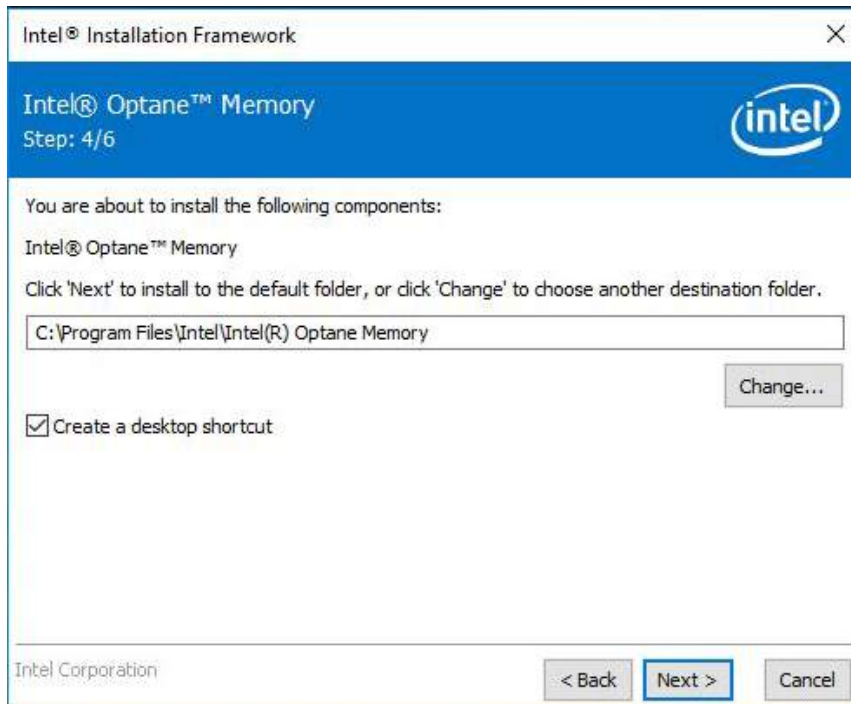
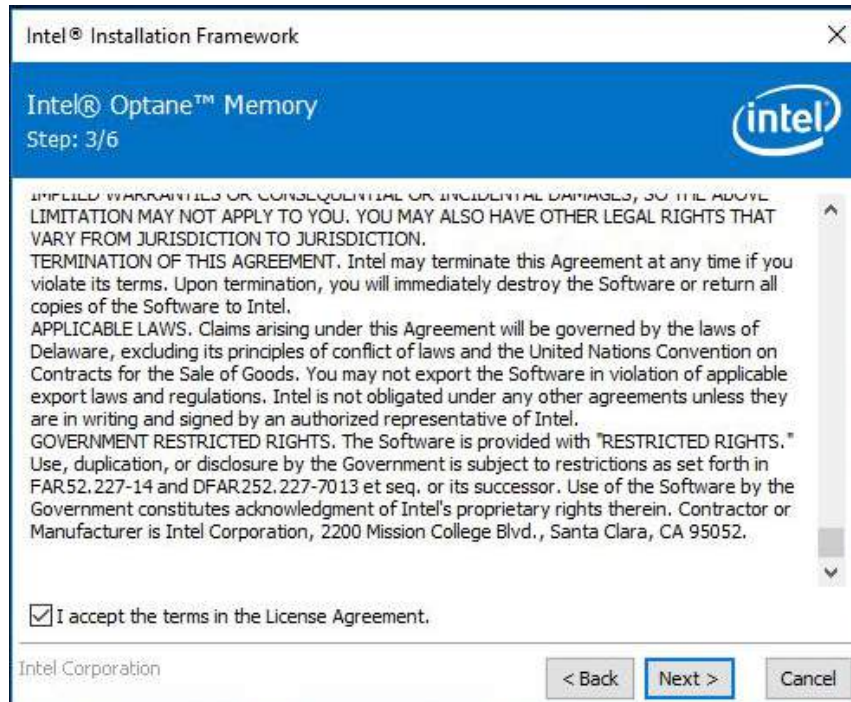

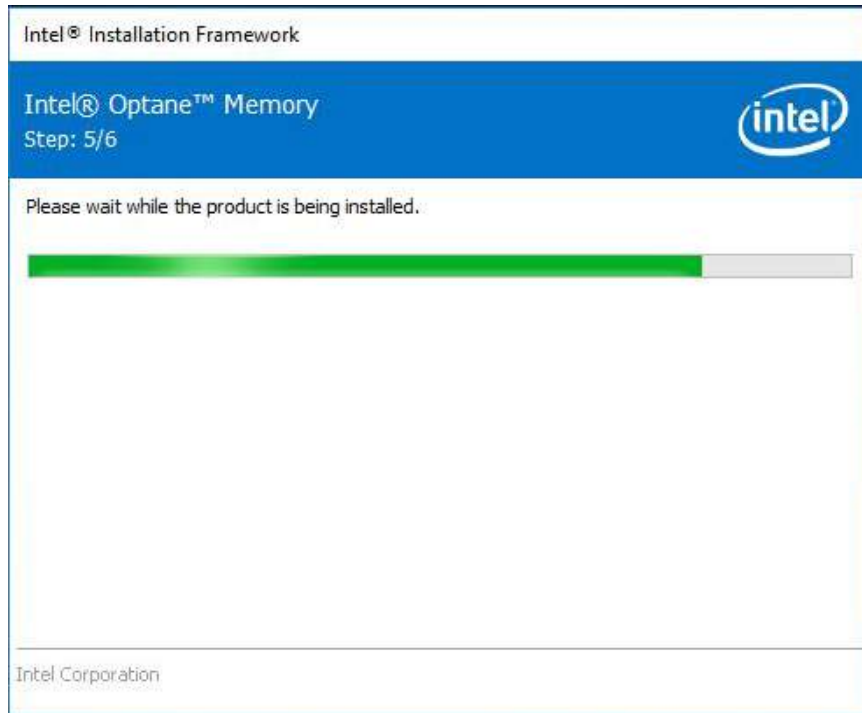

- 9. When done, click on "Finish" and restart the system.

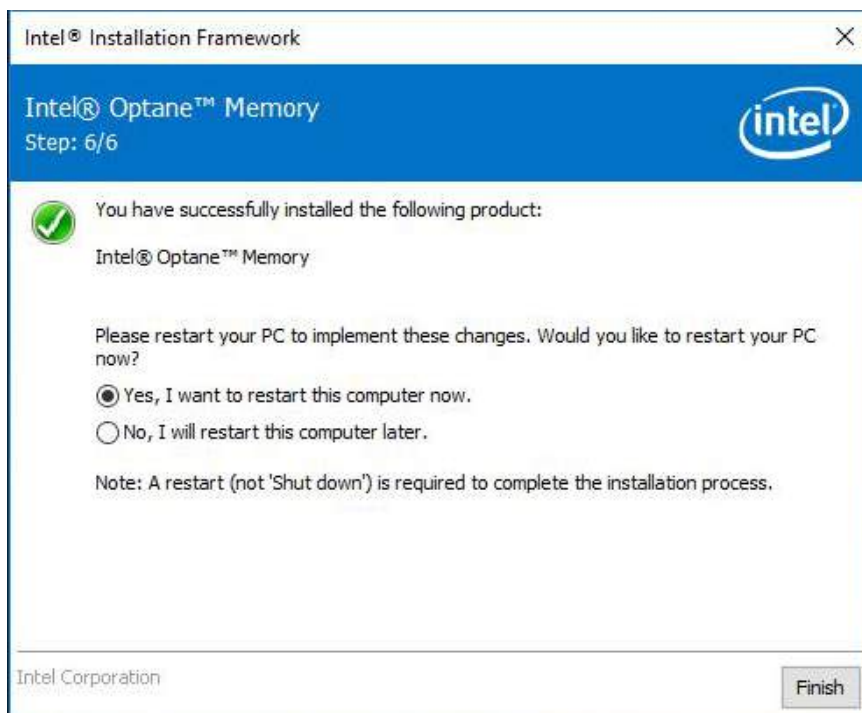

- Upon system restart, the following initialization screen will appear. Click on Next to continue.

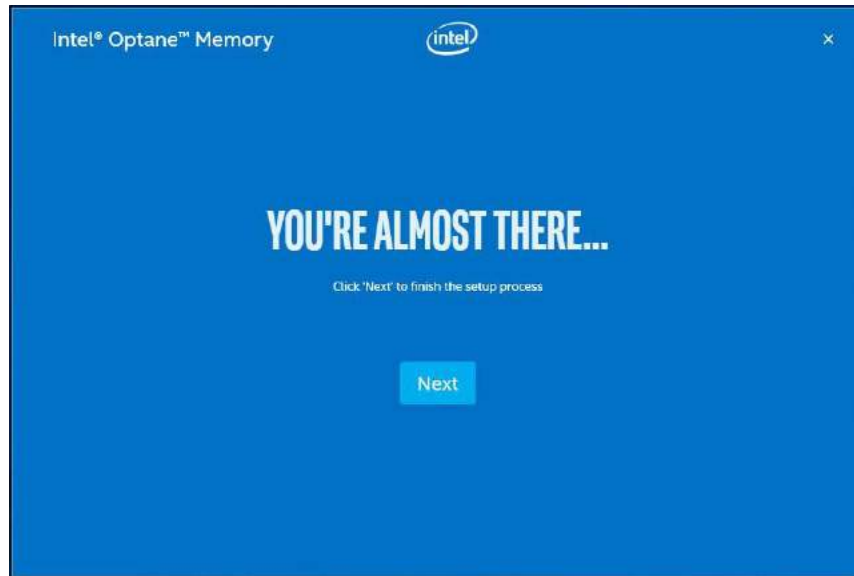

- In the Setup section, you will see your Intel® Optane™ memory drive and compatible drive(s) that can be accelerated. Click on the downward arrow to bring up a selection of drives to be accelerated. Click on “Enable” when ready.

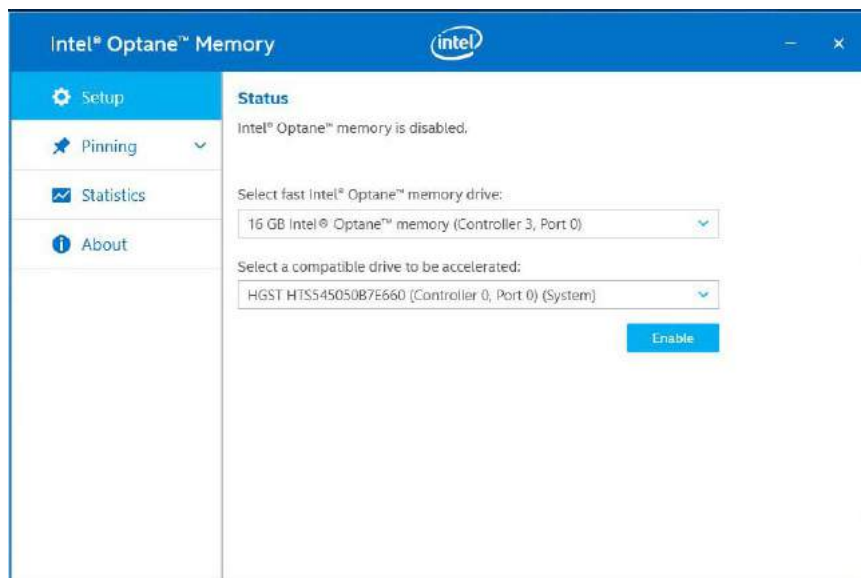

12. The data backup warning will appear, please backup any data you may have stored on your Intel® Optane™ memory module before proceeding. Check the box “Erase all data on Intel® Optane™ memory module” and click on Continue.

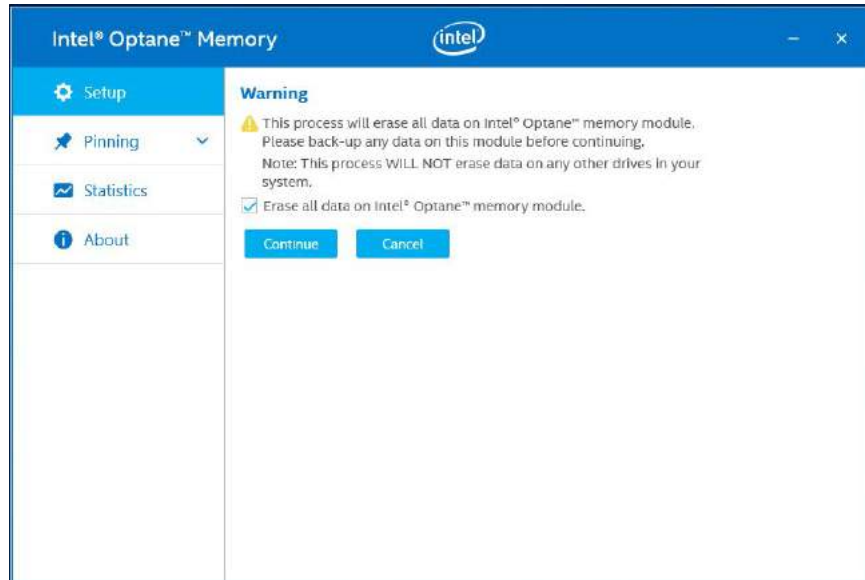

13. When the Intel® Optane™ memory module has been enabled, the installation window and a notification window at the bottom right corner will prompt you to restart the system.

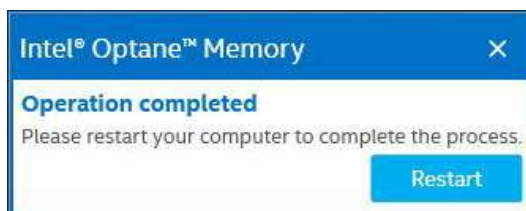
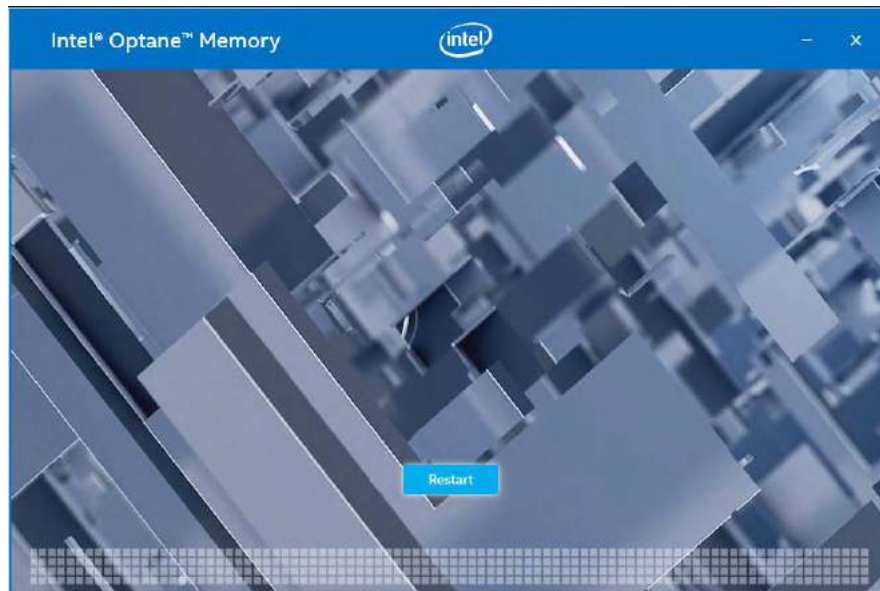

14. Upon system restart, a successful enablement message will appear to indicate the Intel® Optane™ memory module has been enable successfully.

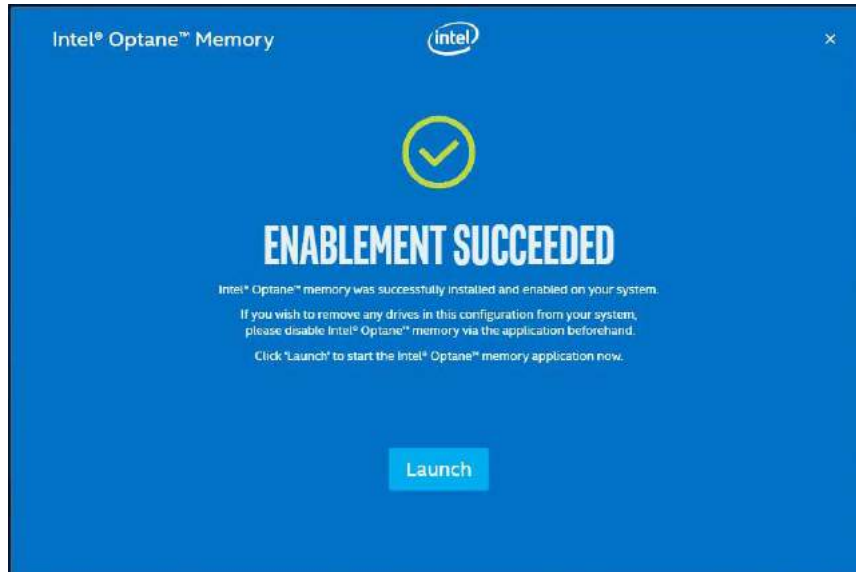

15. Once enabled, the RST software Setup section should show your configuration information.

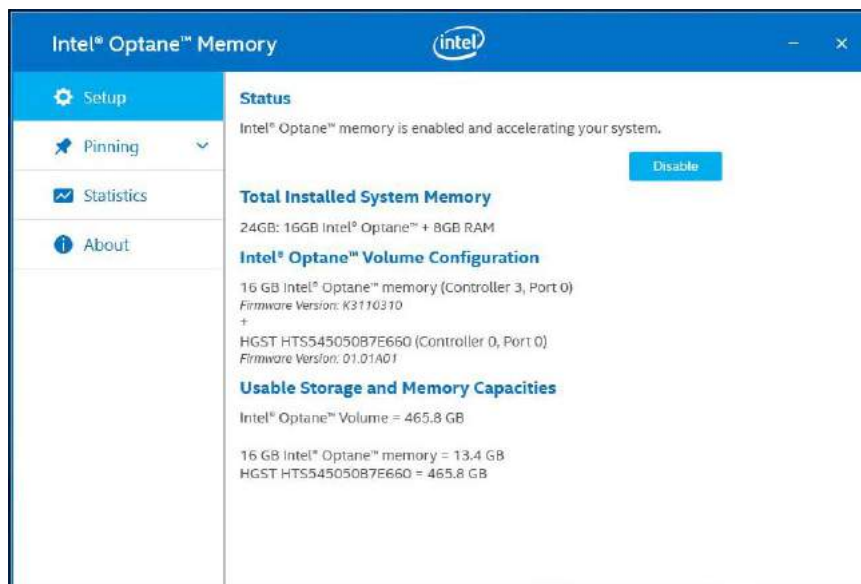

Appendix A Using WDT & DIO

The watchdog timer (WDT) function to ensure reliable system operation. The WDT is a hardware mechanism to reset the system if the watchdog timer is expired. Users can start the WDT and keeping resetting the timer to make sure the system or program is running. Otherwise, the system shall be reset.

In this section, we'll illustrate how to use the function library provided by Neosys to program the WDT functions. Currently, WDT driver library supports Windows 10 x64 and WOW64 platform. For other OS support, please contact Neosys Technology for further information.

Installing WDT_DIO Library

The WDT_DIO function library is delivered in the form of a setup package named **WDT_DIO_Setup.exe**. In prior to program WDT, you should execute the setup program and install the WDT library. Please use the following WDT_DIO_Setup packages according to your operating systems and application.

- For Windows 10 64-bit OS with 64-bit application (x64 mode), please install WDT_DIO_Setup_v2.2.9.x(x64).exe or later version.
- For Windows 10 64-bit OS with 32-bit application (WOW64 mode), please install WDT_DIO_Setup_v2.2.9.x(wow64).exe or later version.

WDT and DIO Library Installation

To setup WDT & DIO Library, please follow instructions below.

1. Execute **WDT_DIO_Setup.2.2.9.x.exe**. and the following dialog appears.

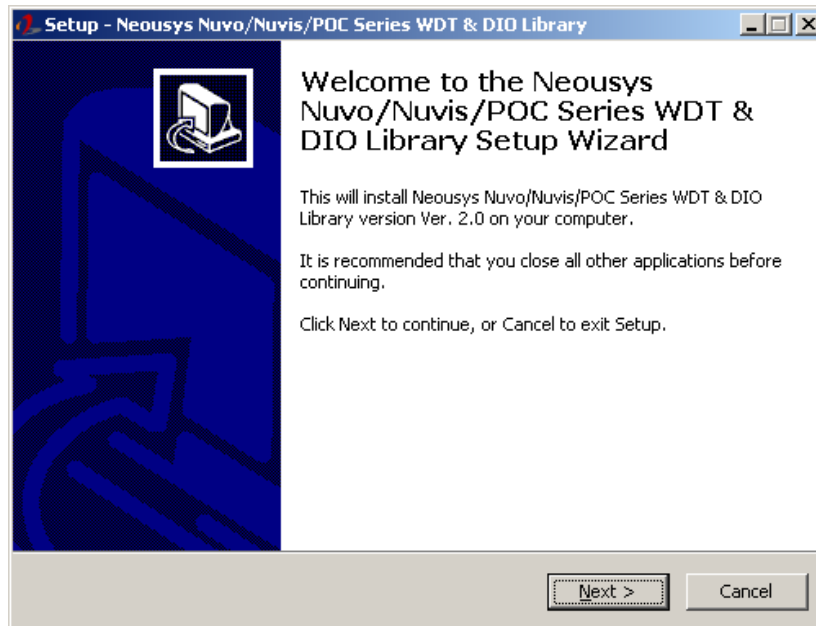

2. Click "Next >" and specify the directory of installing related files. The default directory is *C:\Neosys\WDT_DIO*.

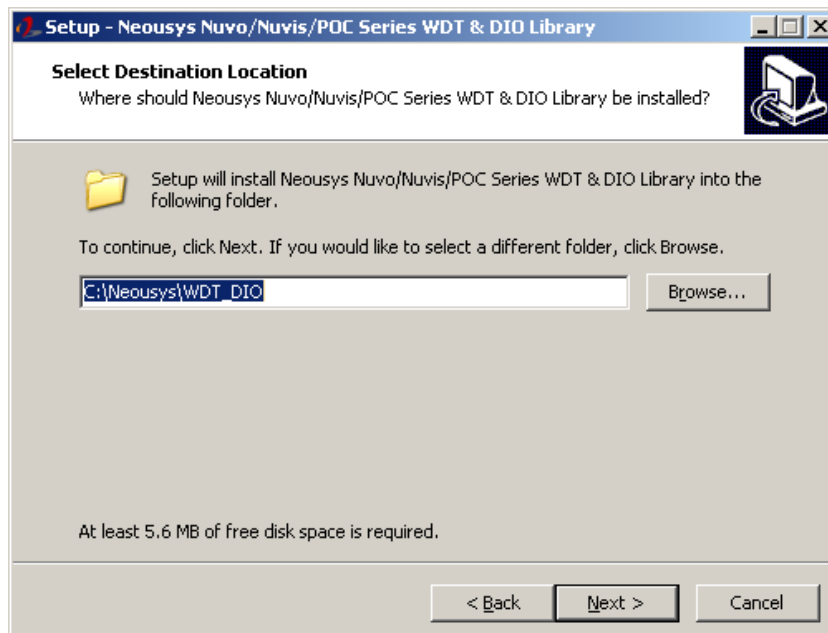

- Once the installation has finished, a dialog will appear to prompt you to reboot the system. The WDT & DIO library will take effect after the system has rebooted.

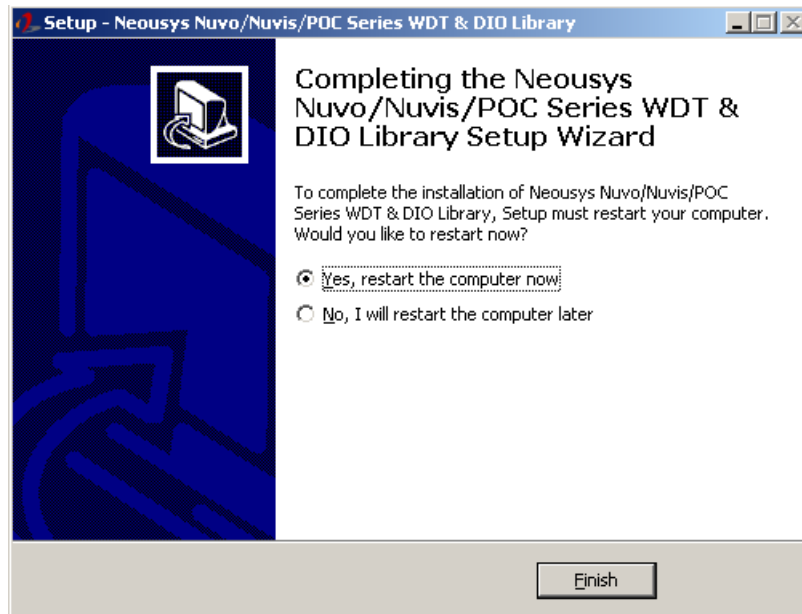

- When programming your WDT or DIO program, the related files are located in

Header File:	\Include
Library File:	\Lib
Function	\Manual
Reference:	
Sample Code:	\Sample\WDT_Demo (Demo for Watchdog Timer)



WDT Functions

InitWDT

Syntax	BOOL InitWDT(void);
Description:	Initialize the WDT function. You should always invoke InitWDT() before set or start watchdog timer.
Parameter	None
Return Value	TRUE: Successfully initialized FALSE: Failed to initialize
Usage	BOOL bRet = InitWDT()

SetWDT

Syntax	BOOL SetWDT(WORD tick, BYTE unit);
Description	Set timeout value and unit for watchdog timer. When InitWDT() is invoked, a default timeout value of 255 seconds is assigned.
Parameter	<i>tick</i> WORD value (1 ~ 65535) to indicate timeout ticks. <i>unit</i> BYTE value (0 or 1) to indicate unit of timeout ticks. 0 : unit is minute 1 : unit is second
Return Value	If value of unit is correct (0 or 1), this function returns TRUE, otherwise FALSE.
Usage	WORD tick=255; BYTE unit=1; //unit is second. BOOL bRet = SetWDT(tick, unit); //timeout value is 255 seconds

StartWDT

Syntax	BOOL StartWDT(void);
Description	Starts WDT countdown. Once started, the WDT LED indicator will begin blinking. If ResetWDT() or StopWDT is not invoked before WDT countdowns to 0, the WDT expires and the system resets.
Parameter	None
Return Value	If the timeout value is given in correct format (WDT started), this function returns TRUE, otherwise FALSE
Usage	BOOL bRet = StartWDT()

ResetWDT

Syntax	BOOL ResetWDT(void);
Description	Reset the timeout value to the value given by SetWDT().If ResetWDT() or StopWDT is not invoked before WDT countdowns to 0, the WDT expires and the system resets.
Parameter	None
Return Value	Always returns TRUE
Usage	BOOL bRet = ResetWDT()

StopWDT

Syntax	BOOL StopWDT(void);
Description	Stops the countdown of WDT. When WDT has stopped, the WDT LED indicator stops blinking.
Parameter	None
Return Value	Always returns TRUE
Usage	BOOL bRet = StopWDT()