

# **Neosys Technology Inc.**

**Nuvo-2600 Series**

**User Manual**

Revision 1.0

# Table of Contents

Table of Contents .....	2
Legal Information .....	4
Contact Information .....	5
Declaration of Conformity .....	5
Copyright Notice .....	6
Safety Precautions .....	7
Hot Surface Warning .....	7
Battery Warning .....	7
Service and Maintenance .....	8
ESD Precautions .....	8
Restricted Access Location .....	8
About This Manual .....	9

## 1 Introduction

<b>1.1 Product Specifications.....</b>	<b>11</b>
1.1.1 Nuvo-2600E .....	11
1.1.2 Nuvo-2600J.....	13
<b>1.2 Nuvo-2600 Dimensions .....</b>	<b>15</b>
1.2.1 Nuvo-2600 Top View .....	15
1.2.2 Nuvo-2600 Front View .....	16
1.2.3 Nuvo-2600 Rear View .....	16
1.2.4 Nuvo-2600 Side View .....	16
<b>1.3 Nuvo-2600 Wall-mount Dimensions.....</b>	<b>17</b>
1.3.1 Top View with Wall-mount Installed.....	17
1.3.2 Panel View with Wall-mount Installed .....	17
1.3.3 Side View with Wall-mount Installed .....	18
1.3.4 Bottom View with Wall-mount Installed .....	18

## 2 System Overview

<b>2.1 Nuvo-2600 Packing List .....</b>	<b>19</b>
<b>2.2 Front Panel I/O .....</b>	<b>20</b>
2.2.1 Power Button .....	22
2.2.2 3.5mm 4-pole Audio Jack.....	22
2.2.3 CMOS Reset Button .....	23
2.2.4 USB3.1 Gen1 Port .....	23
2.2.5 USB2.0 Port.....	24
2.2.6 Reset Button .....	24
2.2.7 COM Ports (COM2/ COM3/ COM4).....	25
2.2.8 COM 1 Port.....	26
2.2.9 System Status LED .....	27
2.2.10 DVI-I Port .....	28
<b>2.3 Rear Panel I/O .....</b>	<b>29</b>
2.3.1 3-pin Terminal Block DC Input/ Optional Ignition Control .....	30
2.3.2 3-pin Remote On/ Off.....	31
2.3.3 RJ45 Power over Ethernet Port (Optional).....	32
2.3.4 Isolated Digital Input/ Output.....	33
<b>2.4 Internal I/O Functions.....</b>	<b>34</b>
2.4.1 M.2 2280 (SATA Signal Only) Slot for SSD .....	34
2.4.2 DRAM SO-DIMM Slot .....	36
2.4.3 Mini-PCIe Slot (USB2.0 Signal Only) .....	37
2.4.4 Mini-PCIe Slot (PCIe and USB2.0 Signal) .....	39
2.4.5 M.2 3042/ 3052 B Key Socket.....	41
2.4.6 Ignition Rotary Switch (Optional).....	43

## 3 System Installation

<b>3.1</b>	<b>Disassembling the System .....</b>	<b>45</b>
<b>3.2</b>	<b>Installing Internal Components .....</b>	<b>47</b>
3.2.1	DDR4 SO-DIMM Installation .....	47
3.2.2	M.2 2280 SSD Installation .....	49
3.2.3	M.2 3042/ 3052 B Key Installation .....	51
3.2.4	miniPICe Installation .....	54
<b>3.3</b>	<b>Installing the System Enclosure .....</b>	<b>56</b>
<b>3.4</b>	<b>2.5" Hard Drive/ SSD Installation .....</b>	<b>59</b>
<b>3.5</b>	<b>PCIe Add-on Card Installation (Nuvo-2600E Only) .....</b>	<b>61</b>
<b>3.6</b>	<b>Wall Mount Bracket for Nuvo-2600 Series (Optional) .....</b>	<b>65</b>
3.6.1	Wall-mounting Nuvo-2600 (Optional Accessory) .....	65
<b>3.7</b>	<b>Powering On the System .....</b>	<b>67</b>
3.7.1	Powering On Using the Power Button .....	67
3.7.2	Powering On Using Wake-on-LAN .....	68
<b>3.8</b>	<b>Ignition Power Control (Optional) .....</b>	<b>70</b>
3.8.1	Principles of Ignition Power Control .....	70
3.8.2	Additional Features of Ignition Power Control .....	71
3.8.3	Wiring Ignition Signal (Optional) .....	72
3.8.4	Configure your Windows system .....	73
3.8.5	Operation Modes of Ignition Power Control (Optional) .....	74

## **4 System Configuration**

<b>4.1</b>	<b>BIOS Settings .....</b>	<b>76</b>
4.1.1	COM 1PortConfiguration .....	77
4.1.2	COM 2/ 3/ 4 Ports .....	78
4.1.3	COM Port High Speed Mode .....	79
4.1.4	Power On After Power Failure Option .....	80
4.1.5	Wake on LAN Option .....	81
4.1.6	Add Boot Options .....	82
4.1.7	Watchdog Timer for Booting .....	83

## **5 OS Support and Driver Installation**

<b>5.1</b>	<b>Operating System Compatibility .....</b>	<b>84</b>
<b>5.2</b>	<b>Driver Installation .....</b>	<b>84</b>
<b>5.3</b>	<b>Driver Installation for Watchdog Timer Control .....</b>	<b>84</b>

## **Appendix A Using WDT & DIO**

<b>Watchdog Timer .....</b>	<b>85</b>
<b>Installing WDT_DIO Library .....</b>	<b>85</b>
<b>WDT and DIO Library Installation .....</b>	<b>86</b>
<b>WDT Functions .....</b>	<b>88</b>
InitWDT .....	88
SetWDT .....	88
StartWDT .....	89
ResetWDT .....	89
StopWDT .....	89
<b>DIO Functions .....</b>	<b>90</b>
InitDIO .....	90
DReadLine .....	90
DReadPort .....	90
DWriteLine .....	91
DWritePort .....	91

## **Appendix B PoE On/ Off Control**

<b>GetStatusPoEPort .....</b>	<b>92</b>
<b>EnablePoEPort .....</b>	<b>93</b>
<b>DisablePoEPort .....</b>	<b>94</b>

# Legal Information

All Neosys Technology Inc. products shall be subject to the latest Standard Warranty Policy

Neosys Technology Inc. may modify, update or upgrade the software, firmware or any accompanying user documentation without any prior notice. Neosys Technology Inc. will provide access to these new software, firmware or documentation releases from download sections of our website or through our service partners.

Before installing any software, applications or components provided by a third party, customer should ensure that they are compatible and interoperable with Neosys Technology Inc. product by checking in advance with Neosys Technology Inc.. Customer is solely responsible for ensuring the compatibility and interoperability of the third party's products. Customer is further solely responsible for ensuring its systems, software, and data are adequately backed up as a precaution against possible failures, alternation, or loss.

For questions in regards to hardware/ software compatibility, customers should contact Neosys Technology Inc. sales representative or technical support.

To the extent permitted by applicable laws, Neosys Technology Inc. shall NOT be responsible for any interoperability or compatibility issues that may arise when (1) products, software, or options not certified and supported; (2) configurations not certified and supported are used; (3) parts intended for one system is installed in another system of different make or model.

# Contact Information

---

**Headquarters**  
**(Taipei, Taiwan)**

**Neosys Technology Inc.**  
15F, No.868-3, Zhongzheng Rd., Zhonghe Dist., New Taipei City, 23586, Taiwan  
Tel: +886-2-2223-6182 Fax: +886-2-2223-6183 [Email](#), [Website](#)

---

**Americas**  
**(Illinois, USA)**

**Neosys Technology America, Inc.**  
3384 Commercial Avenue, Northbrook, IL 60062, USA  
Tel: +1-847-656-3298 [Email](#), [Website](#)

---

**China**

**Neosys Technology China Co., Ltd.**  
Room 429 /431, Building 32, Guiping Road 680, Shanghai, 200233, China  
Tel: +86-2161155366 [Email](#), [Website](#)

---

# Declaration of Conformity

**FCC**

This equipment has been tested and found to comply with the limits for a Class A digital device, pursuant to part 15 of the FCC Rules. These limits are designed to provide reasonable protection against harmful interference when the equipment is operated in a commercial environment. This equipment generates, uses, and can radiate radio frequency energy and, if not installed and used in accordance with the instruction manual, may cause harmful interference to radio communications. Operation of this equipment in a residential area is likely to cause harmful interference in which case the user will be required to correct the interference at own expense.

---

**CE**

The product(s) described in this manual complies with all applicable European Union (CE) directives if it has a CE marking. For computer systems to remain CE compliant, only CE-compliant parts may be used. Maintaining CE compliance also requires proper cable and cabling techniques.

# Copyright Notice

All rights reserved. This publication may not be reproduced, transmitted, transcribed, stored in a retrieval system, or translated into any language or computer language, in any form or by any means, electronic, mechanical, magnetic, optical, chemical, manual or otherwise, without the prior written consent of Neosys Technology, Inc.

---

## **Disclaimer**

This manual is intended to be used as an informative guide only and is subject to change without prior notice. It does not represent commitment from Neosys Technology Inc. Neosys Technology Inc. shall not be liable for any direct, indirect, special, incidental, or consequential damages arising from the use of the product or documentation, nor for any infringement on third party rights.

---

## **Patents and Trademarks**

Neosys, the Neosys logo, Expansion Cassette, MezIO™ are registered patents and trademarks of Neosys Technology, Inc.

Windows is a registered trademark of Microsoft Corporation.

Intel®, Core™ are registered trademarks of Intel Corporation

NVIDIA®, GeForce® are registered trademarks of NVIDIA Corporation

All other names, brands, products or services are trademarks or registered trademarks of their respective owners.

# Safety Precautions

Read these instructions carefully before you install, operate, or transport the system.

- Install the system or DIN rail associated with, at a sturdy location
- Install the power socket outlet near the system where it is easily accessible
- Secure each system module(s) using its retaining screws
- Place power cords and other connection cables away from foot traffic. Do not place items over power cords and make sure they do not rest against data cables
- Shutdown, disconnect all cables from the system and ground yourself before touching internal modules
- Ensure that the correct power range is being used before powering the device
- Should a module fail, arrange for a replacement as soon as possible to minimize down-time
- By means of a power cord connected to a socket-outlet with earthing connection
- This product is intended to be supplied by a Listed Power Adapter or DC power source, rated 24Vdc, 16A, Tma 60 degree C and 5000m altitude during operation. If further assistance is required, please contact Neousys Technology
- If the system is not going to be used for a long time, disconnect it from mains (power socket) to avoid transient over-voltage

## Hot Surface Warning



*HOT SURFACE. DO NOT TOUCH.*"ATTENTION: Surface chaude. Ne pas toucher."

### **WARNING!**

Components/ parts inside the equipment may be hot to touch!  
Please wait one-half hour after switching off before handling parts.

## Battery Warning

*Caution!*



- Batteries are at risk of exploding if incorrectly installed
- Do not attempt to recharge, force open, or heat the battery
- Replace the battery only with the same or equivalent type recommended by the manufacturer

## Service and Maintenance

- ONLY qualified personnel should service the system
- Shutdown the system, disconnect the power cord and all other connections before servicing the system
- When replacing/ installing additional components (expansion card, memory module, etc.), insert them as gently as possible while assuring proper connector engagement

## ESD Precautions

- Handle add-on module, motherboard by their retention screws or the module's frame/ heat sink. Avoid touching the PCB circuit board or add-on module connector pins
- Use a grounded wrist strap and an anti-static work pad to discharge static electricity when installing or maintaining the system
- Avoid dust, debris, carpets, plastic, vinyl and styrofoam in your work area
- Do not remove any module or component from its anti-static bag before installation

## Restricted Access Location

The controller is intended for installation only in certain environments where both of the following conditions apply:

- Access can only be gained by **QUALIFIED SERVICE PERSONNEL** who have been instructed on the reasons for restrictions applied to the location and any precautions that shall be taken
- Access is through the use of a **TOOL**, lock and key, or other means of security, and is controlled by the authority responsible for the location



# About This Manual

This guide introduces Neosys Nuvo-2600 series system, an Intel® Elkhart Lake Atom® fanless in-vehicle computer.

The guide also demonstrates the system's basic installation procedures.

## Revision History

Version	Date	Description
1.0	Oct. 2022	Initial release

# 1 Introduction

The Nuvo-2600 series is an Intel® Elkhart Lake Atom® fanless computer with flexible expansions to fulfill versatile factory automation and machine vision applications that require a compact footprint, Gigabit PoE+ capability, and front-accessible data storage with CPU performance at 12W of low power consumption..



Front panel

Rear panel

Powered by Intel® Elkhart Lake Atom® x6425E quad-core CPU, the Nuvo-2600 series delivers 320% CPU performance improvement compared with our previous Nuvo-2500E series. The Nuvo-2600 series has four Gigabit PoE+ and one USB 3.1 ports with screw-lock mechanisms to secure camera connections. In addition to its internal M.2 2280 SATA SSD for system storage, Nuvo-2600 has one front-accessible 2.5" HDD tray accommodating a 7-15mm 2.5" SSD/HDD up to 5TB in storage capacity. It also has one isolated RS-485 port and isolated DIO to provide robust connections with industrial devices. For internal expansion, the Nuvo-2600 series provides two mini-PCIe sockets and one M.2 3042/3052 B Key socket to support 4G/ 5G mobile broadband.

To meet diverse deployment requirements, the Nuvo-2600 series comes in two variants. The Nuvo-2600E has a PCIe Cassette for an additional PCIe card, e.g., USB or GbE frame grabber, isolated DIO, or industrial communication card. While Nuvo-2600J has an integrated SuperCAP UPS that can withstand power interruption or voltage fluctuation in industrial environments. Featuring Intel Elkhart Lake Atom® quad-core CPU, wide temperature operation, industrial I/O interfaces, and expansion Cassette module, Nuvo-2600 series is the perfect, multi-purpose fanless Industrial PC for factory automation and machine vision applications.

## 1.1 Product Specifications

### 1.1.1 Nuvo-2600E

<b>System Core</b>	
<b>Processor</b>	Intel® Elkhart Lake Atom® x6425E quad-core 2.0GHz/3.0GHz 12W processor
<b>Graphics</b>	Integrated Intel® UHD Graphics
<b>Memory</b>	Up to 32GB DDR4-3200 SDRAM by one SODIMM socket
<b>I/O Interface</b>	
<b>Ethernet Port</b>	4x Gigabit Ethernet ports via RJ-45 connectors by Intel® I210 with screw-lock
<b>Power over Ethernet</b>	In compliance with IEEE 802.3at PoE+ PSE, maximum 25.5W output per port. Compatible with 802.3at (PoE+) and 802.3af (PoE) PD
<b>USB</b>	1x USB 3.2 Gen1 (5 Gbps) ports with screw-lock 2x USB 2.0 port with screw-lock
<b>Video Port</b>	VGA and DVI dual display outputs via one DVI-I connector
<b>Serial Port</b>	1x isolated RS-485 port with 15 kV ESD protection (COM1) 3x 3-wire RS-232 ports (COM2/3/4) or 1x RS-422/485 (COM2)
<b>Isolated DIO</b>	4-CH isolated DI and 4-CH isolated DO
<b>Audio</b>	1x 3.5 mm jack for mic-in and speaker-out
<b>Storage Interface</b>	
<b>M.2 SATA</b>	1x M.2 2280 M key (SATA interface only) socket for SATA SSD installation
<b>SATA HDD</b>	1x front-accessible HDD tray for 2.5" HDD/ SSD installation (up to 15mm height)
<b>Internal I/O</b>	
<b>PCIe</b>	1x PCIe x4 slot @ 2-lane PCIe 3.0 signal in Cassette module
<b>Mini PCI Express</b>	1x full-size mini PCI Express socket with PCIe and USB 2.0 signal 1x full-size mini PCI Express socket with USB 2.0 signal
<b>M.2 B Key</b>	1x M.2 3042/3052 B key (USB 3.1 + USB 2.0) for 4G/ 5G module with dual internal micro SIM sockets
<b>Power Supply</b>	
<b>DC Input</b>	1x 3-pin pluggable terminal block for 8V to 35V DC input with built-in ignition power control (IGN/ GND/ V+)
<b>Remote Ctrl. &amp; LED Output</b>	1x 3-pin pluggable terminal block for remote control and PWR LED output

<b>Max. Power Consumption</b>	<ul style="list-style-type: none"> <li>● CPU 12W / 16GB D4-3200 / 256 GB SATA SSD - 100% CPU loading: 32W @ 35V</li> <li>● CPU 12W / 16GB D4-3200 / 256 GB SATA SSD - 100% CPU loading + 4x PoE (25.5W each): 135W @ 35V</li> </ul>
<b>Mechanical</b>	
<b>Dimension</b>	205 mm (W) x 156 mm (D) x 86.15 mm (H)
<b>Weight</b>	2.3Kg
<b>Mounting</b>	Wall-mount (optional)
<b>Environmental</b>	
<b>Operating Temperature</b>	-25°C to 70°C*
<b>Storage Temperature</b>	-40°C to 85°C*
<b>Humidity</b>	10%~90% , non-condensing
<b>Vibration</b>	Operating, MIL-STD-810G, Method 514.7, Category 4
<b>Shock</b>	Operating, MIL-STD-810G, Method 516.7, Procedure I
<b>EMC</b>	CE/FCC Class A, according to EN 55032 & EN 55035

\* For sub-zero and over 50°C ambient operating temperatures, a wide temperature HHD or Solid State Disk (SSD) is required.

### 1.1.2 Nuvo-2600J

<b>System Core</b>	
<b>Processor</b>	Intel® Elkhart Lake Atom® x6425E quad-core 2.0GHz/3.0GHz 12W processor
<b>Graphics</b>	Integrated Intel® UHD Graphics
<b>Memory</b>	Up to 32GB DDR4-3200 SDRAM by one SODIMM socket
<b>I/O Interface</b>	
<b>Ethernet Port</b>	4x Gigabit Ethernet ports via RJ-45 connectors by Intel® I210 with screw-lock
<b>Power over Ethernet</b>	In compliance with IEEE 802.3at PoE+ PSE, maximum 25.5W output per port. Compatible with 802.3at (PoE+) and 802.3af (PoE) PD
<b>USB</b>	1x USB 3.2 Gen1 (5 Gbps) ports with screw-lock 2x USB 2.0 port with screw-lock
<b>Video Port</b>	VGA and DVI dual display outputs via one DVI-I connector
<b>Serial Port</b>	1x isolated RS-485 port with 15 kV ESD protection (COM1) 3x 3-wire RS-232 ports (COM2/3/4) or 1x RS-422/485 (COM2)
<b>Isolated DIO</b>	4-CH isolated DI and 4-CH isolated DO
<b>Audio</b>	1x 3.5 mm jack for mic-in and speaker-out
<b>Storage Interface</b>	
<b>M.2 SATA</b>	1x M.2 2280 M key (SATA interface only) socket for SATA SSD installation
<b>SATA HDD</b>	1x front-accessible HDD tray for 2.5" HDD/ SSD installation (up to 15mm height)
<b>Internal I/O</b>	
<b>Mini PCI Express</b>	1x full-size mini PCI Express socket with PCIe and USB 2.0 signal 1x full-size mini PCI Express socket with USB 2.0 signal
<b>M.2 B Key</b>	1x M.2 3042/3052 B key (USB 3.1 + USB 2.0) for 4G/ 5G module with dual internal micro SIM sockets
<b>Power Supply</b>	
<b>DC Input</b>	1x 3-pin pluggable terminal block for 8V to 35V DC input with built-in ignition power control (IGN/ GND/ V+)
<b>Remote Ctrl. &amp; LED Output</b>	1x 3-pin pluggable terminal block for remote control and PWR LED output
<b>Power Backup Module</b>	Supercapacitor 2500 watt-second power backup module

<b>Max. Power Consumption</b>	<ul style="list-style-type: none"> <li>● CPU 12W / 16GB D4-3200 / 256 GB SATA SSD - 100% CPU loading: 32W @ 35V</li> <li>● CPU 12W / 16GB D4-3200 / 256 GB SATA SSD - 100% CPU loading + 4x PoE (25.5W each): 135W @ 35V</li> </ul>
<b>Mechanical</b>	
<b>Dimension</b>	205 mm (W) x 156 mm (D) x 86.15 mm (H)
<b>Weight</b>	2.5Kg
<b>Mounting</b>	Wall-mount (optional)
<b>Environmental</b>	
<b>Operating Temperature</b>	-25°C to 70°C*
<b>Storage Temperature</b>	-40°C to 85°C*
<b>Humidity</b>	10%~90% , non-condensing
<b>Vibration</b>	Operating, MIL-STD-810G, Method 514.7, Category 4
<b>Shock</b>	Operating, MIL-STD-810G, Method 516.7, Procedure I
<b>EMC</b>	CE/FCC Class A, according to EN 55032 & EN 55035

\* For sub-zero and over 50°C ambient operating temperatures, a wide temperature HHD or Solid State Disk (SSD) is required.

## 1.2 Nuvo-2600 Dimensions



### NOTE

*The Nuvo-2600 series share the same dimensions. All measurements are in millimeters (mm).*

### 1.2.1 Nuvo-2600 Top View

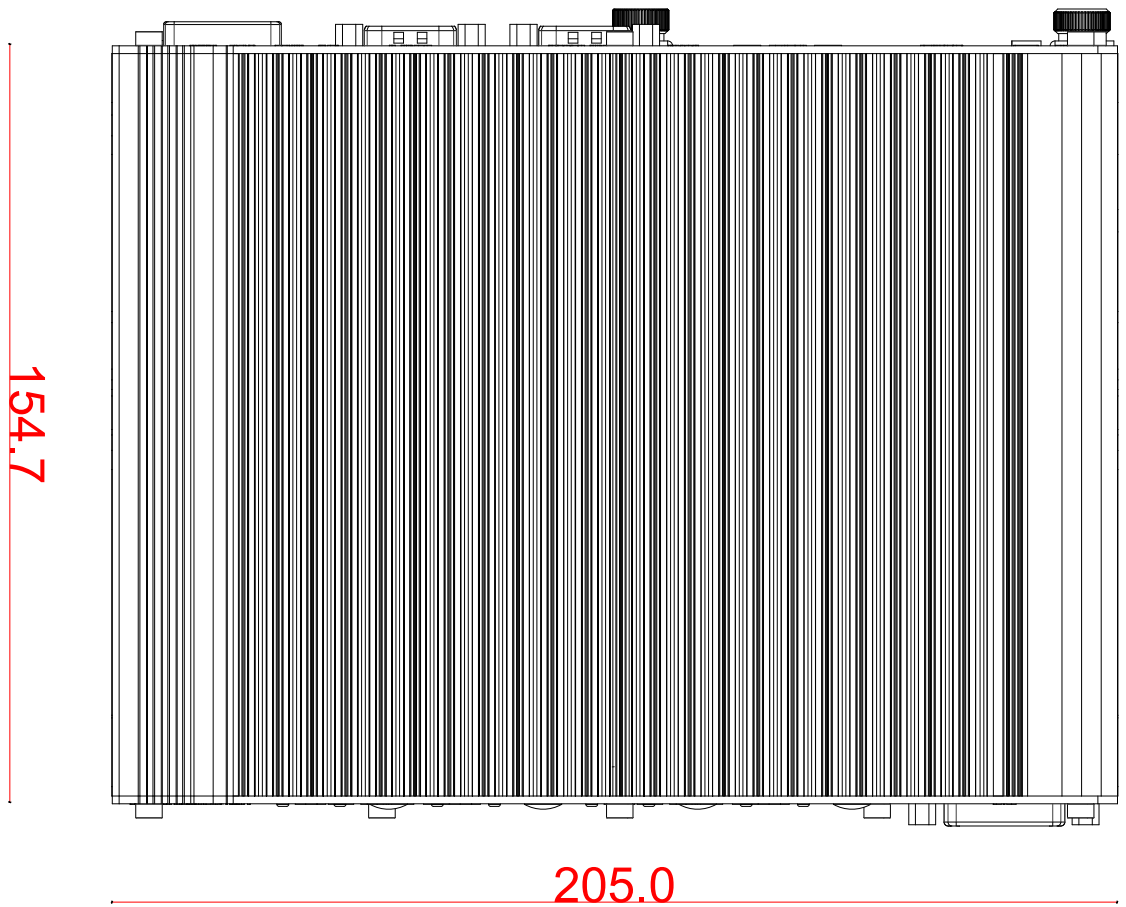

### 1.2.2 Nuvo-2600 Front View

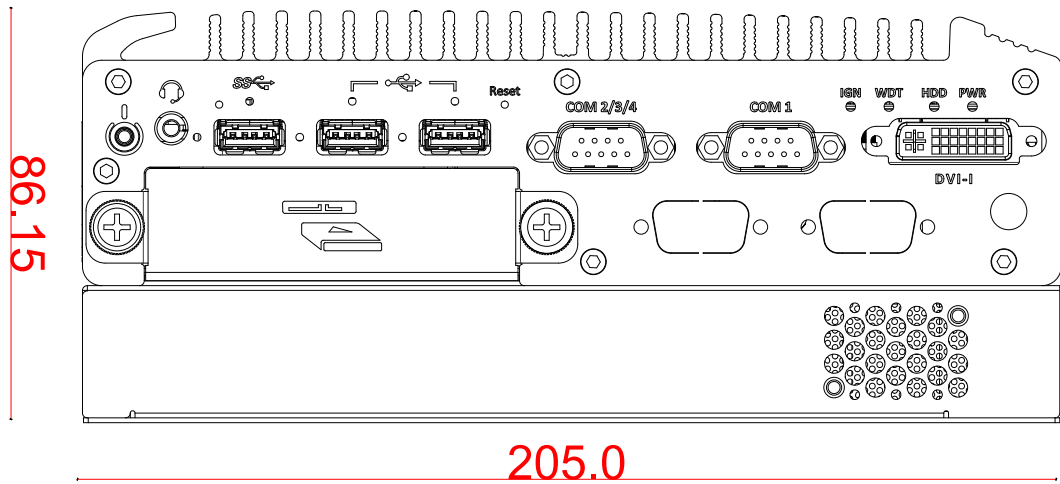

### 1.2.3 Nuvo-2600 Rear View

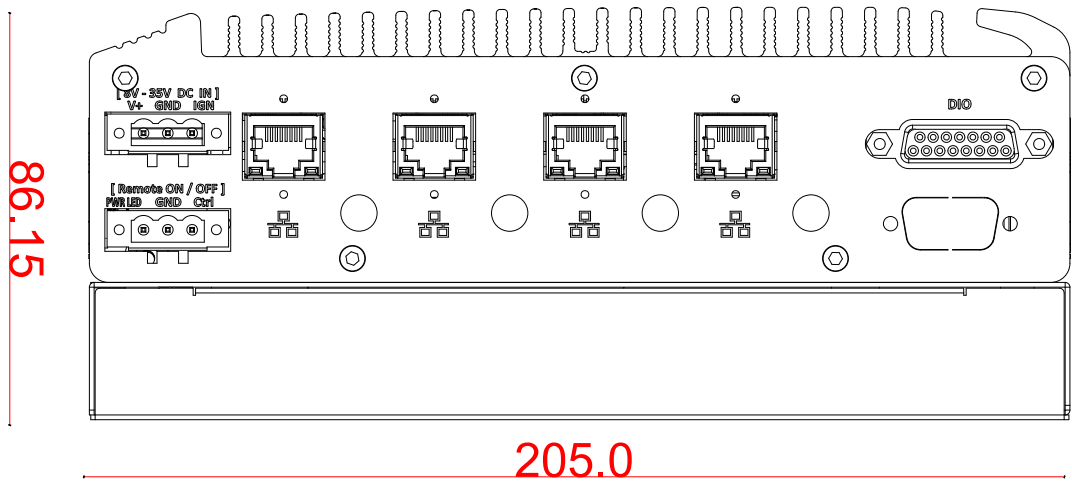

### 1.2.4 Nuvo-2600 Side View

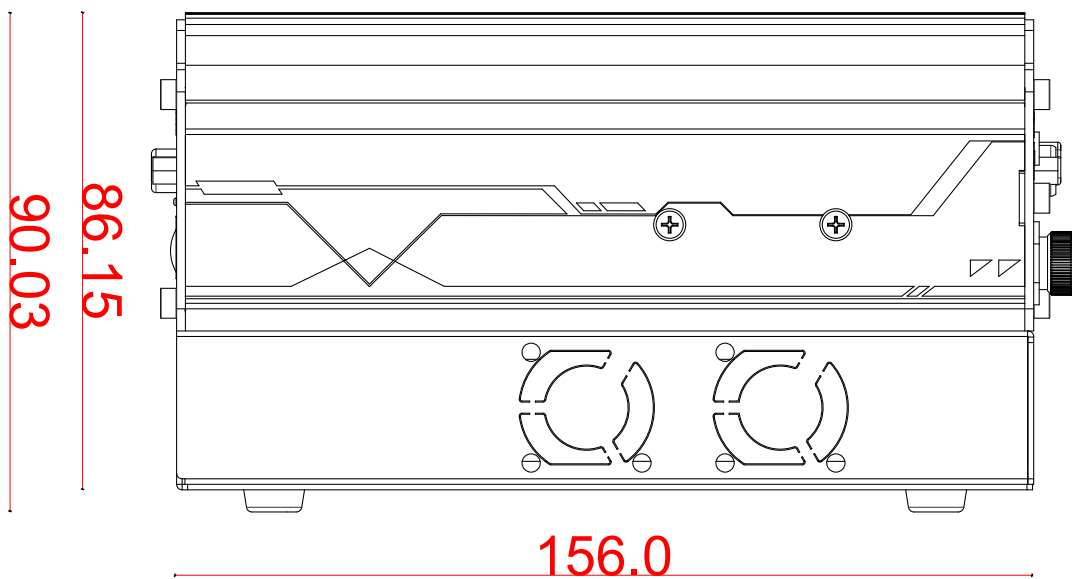



### 1.3 Nuvo-2600 Wall-mount Dimensions

 **NOTE**  
*All measurements are in millimeters (mm).*

#### 1.3.1 Top View with Wall-mount Installed

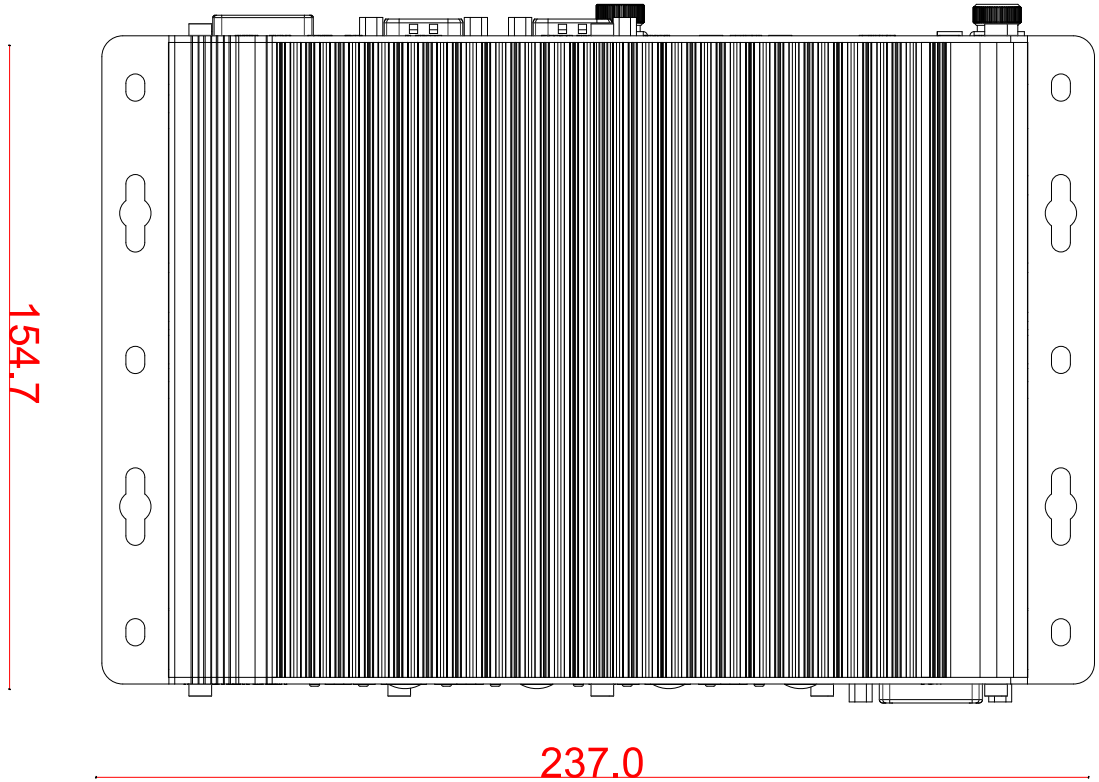

#### 1.3.2 Panel View with Wall-mount Installed

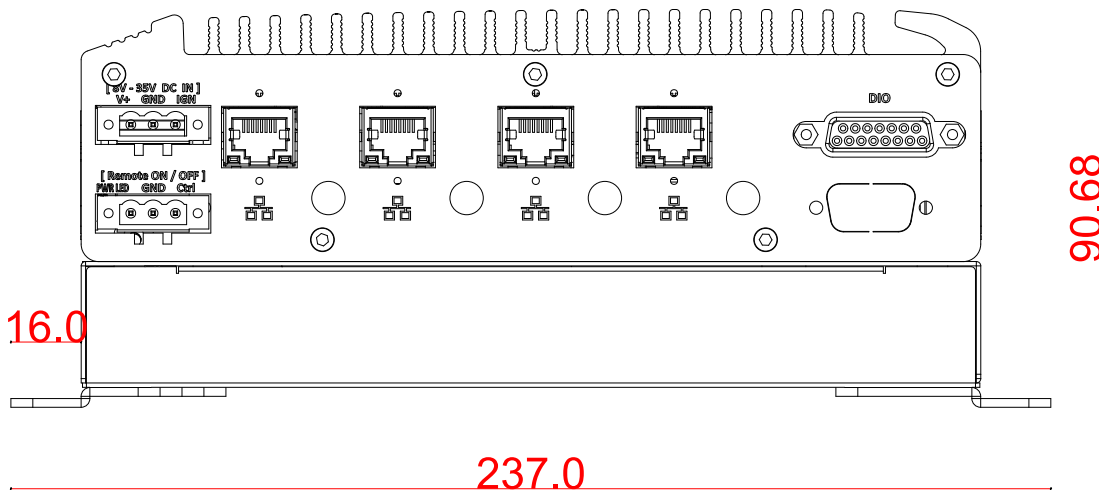

### 1.3.3 Side View with Wall-mount Installed

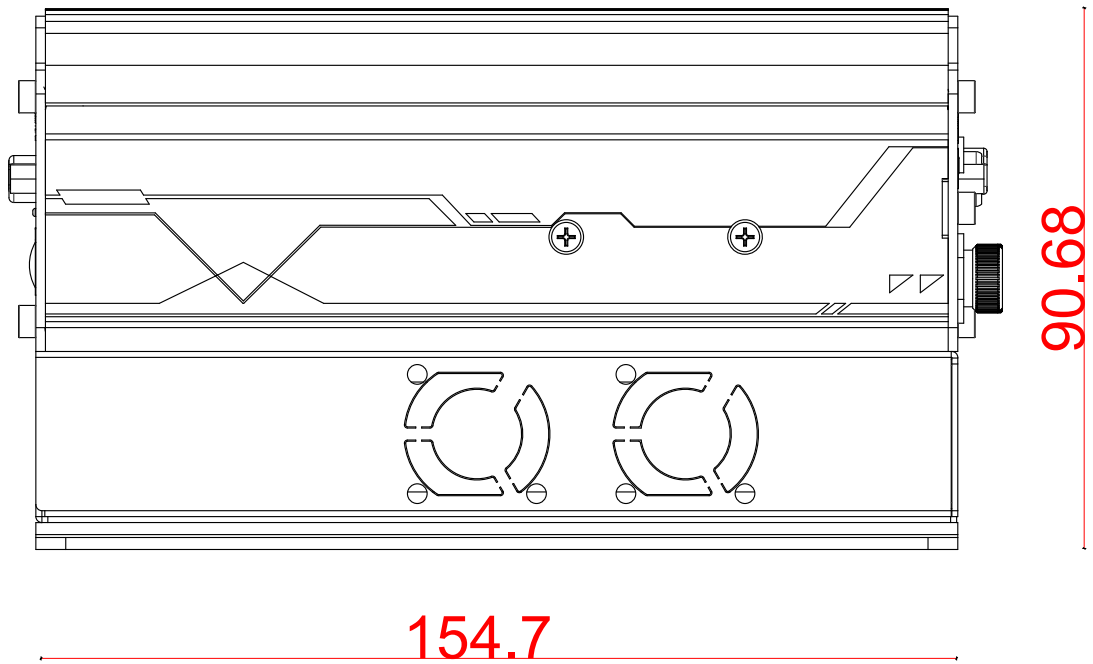

### 1.3.4 Bottom View with Wall-mount Installed

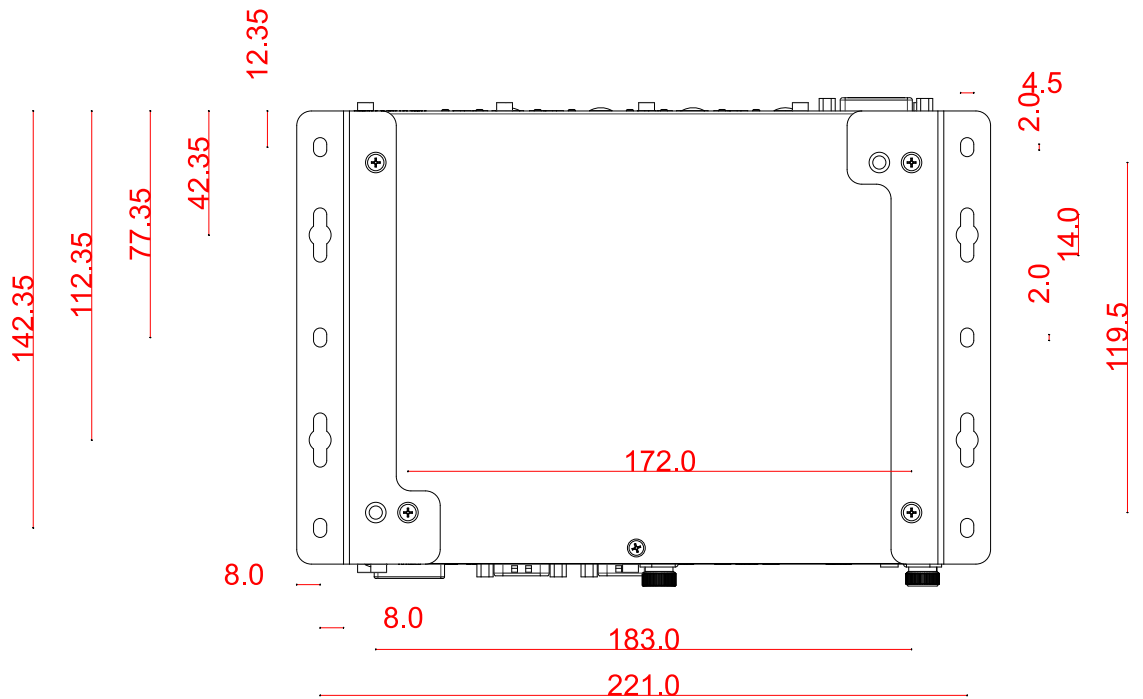

## 2 System Overview

Upon receiving and unpacking your Nuvo-2600 series system, please check immediately if the package contains all the items listed in the following table. If any item(s) are missing or damaged, please contact your local dealer or Neousys Technology.

### 2.1 Nuvo-2600 Packing List

System Pack	Nuvo-2600	Qty
1	Nuvo-2600 series system (If you ordered RAM/SSD or HDD, please verify these items)	1
2	Accessory box, which contains <ul style="list-style-type: none"> <li>● 3-pin power terminal block</li> <li>● M3 standoff for M.2 B Key module</li> <li>● Rubber spacer (8x8x6 mm)</li> <li>● Wall mount assembly (optional)</li> </ul>	1 1 4 2

## 2.2 Front Panel I/O



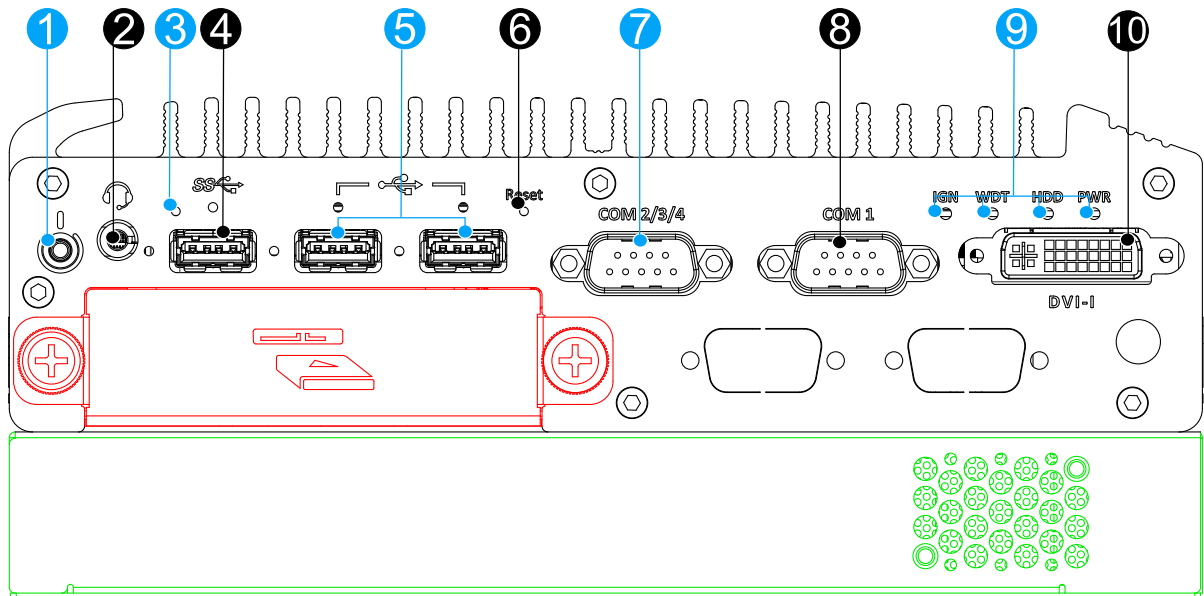

### NOTE

For demonstration purposes, Nuvo-2600E-PoE-IGN illustration will be used.



No.	Item	Description
1	<a href="#">Power button</a>	Use this button to turn on or shutdown the system.
2	<a href="#">3.5mm 4-pole audio jack</a>	The 4-pole 3.5mm jack accepts microphone voice input and headphone speaker sound output.
3	<a href="#">CMOS reset button</a>	Use this button to manually reset the CMOS
4	<a href="#">USB 3.1 Gen1 port</a>	USB 3.0 port supports up to 5 Gbit/s data transfer bandwidth.
5	<a href="#">USB 2.0</a>	USB 2.0 port supports up to 480Mb/s data transfer bandwidth.
6	<a href="#">Reset button</a>	Use this button to manually reset the system.
7	<a href="#">COM port 2/ 3/ 4</a>	<b>Can be configured as:</b> <b>COM2:</b> single RS-422/ 485 port <b>COM2/ COM3/ COM4:</b> three 3-wire RS-232 ports
8	<a href="#">COM port 1</a>	Isolated RS-485 port with 15 kV ESD protection
9	<a href="#">System status LEDs</a>	Four system LEDs, ignition (IGN), watchdog timer (WDT), hard disk drive (HDD) and power (PWR).
10	<a href="#">DVI-I port</a>	DVI-I offers both DVI and VGA signals. You can use the DVI-to-VGA adapter to connect a VGA display, or use Y-cable to

		<p>have DVI/VGA dual display output. They support resolutions up to 1920 x 1080.</p>
		<p>Front-accessible 2.5" HDD tray (supports up to 15mm in height), please refer to the <a href="#">2.5" hard drive/ SSD installation</a> section for details.</p>
		<p>Cassette module enclosure (Nuvo-2611VTC/ Nuvo 2612VTC only).</p>

### 2.2.1 Power Button

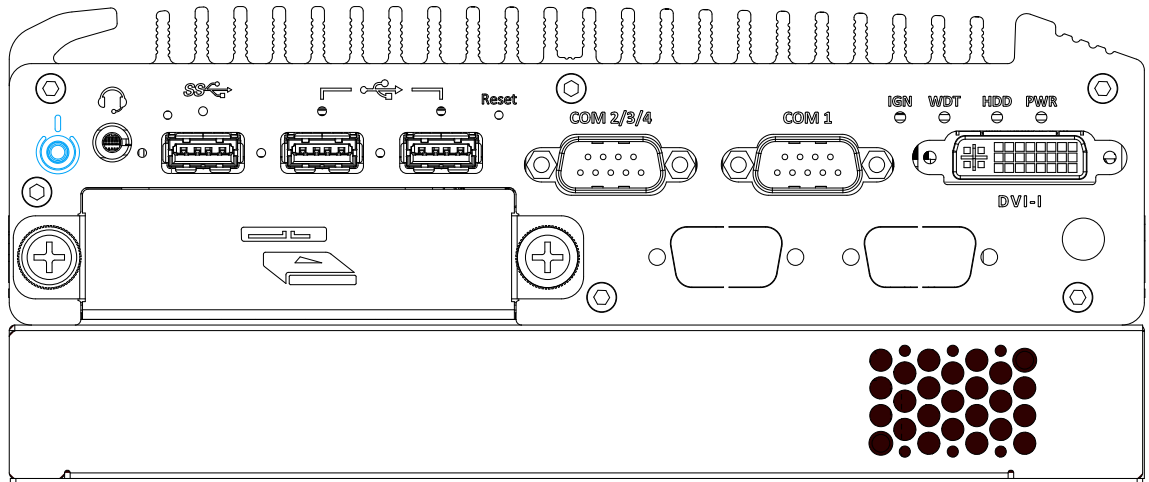

The power button is a non-latched switch for ATX mode on/off operation. Press to turn on the system, PWR LED should light up and to turn off, you can either issue a shutdown command in the OS, or just press the power button. In case of system halts, you can press and hold the power button for 5 seconds to force-shutdown the system. Please note that there is a 5 seconds interval between two on/off operations (i.e. once turning off the system, you will need to wait for 5 seconds to initiate another power-on operation).

### 2.2.2 3.5mm 4-pole Audio Jack

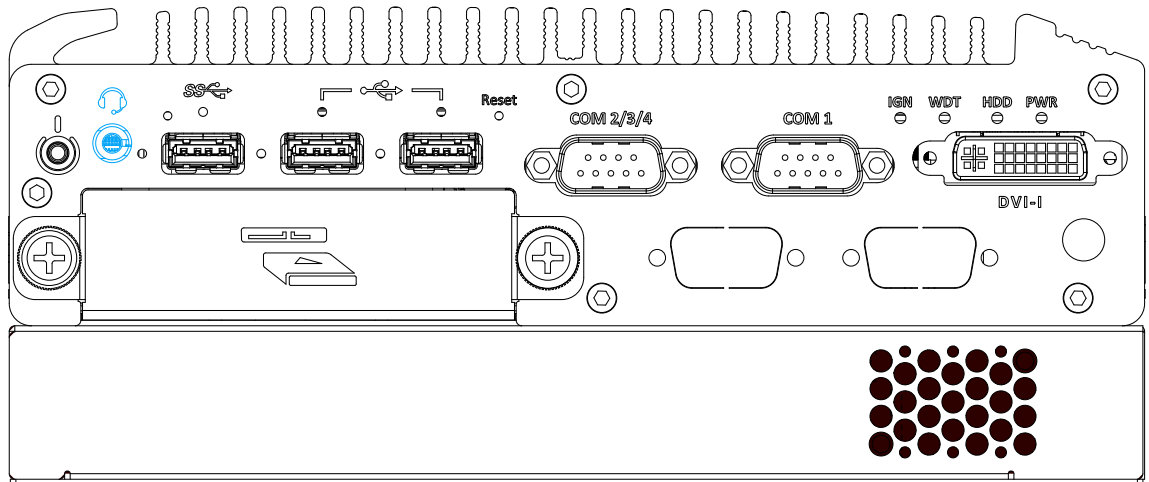

There is a female 4-pole  audio jack for headphone (speaker) output and microphone input. To utilize the audio function in Windows, you need to install corresponding drivers. Please refer to the section, [Driver Installation](#).

### 2.2.3 CMOS Reset Button

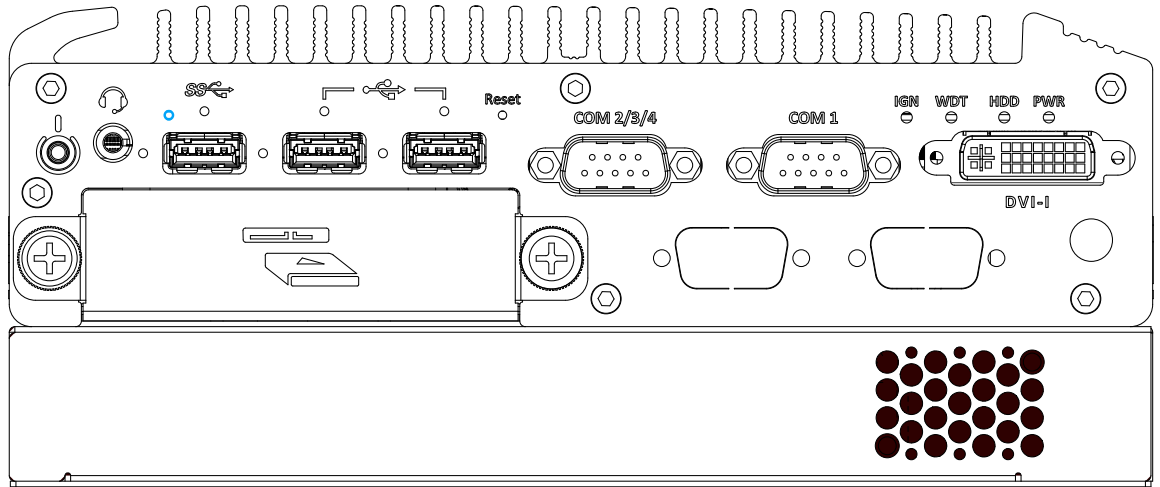

The CMOS Reset button is used to manually reset the motherboard BIOS in case of system halt or malfunction. To avoid unexpected operation, it is purposely placed behind the panel. To reset, please use the tip of a pen, press and hold for at least 5 seconds to reset the BIOS.

### 2.2.4 USB3.1 Gen1 Port

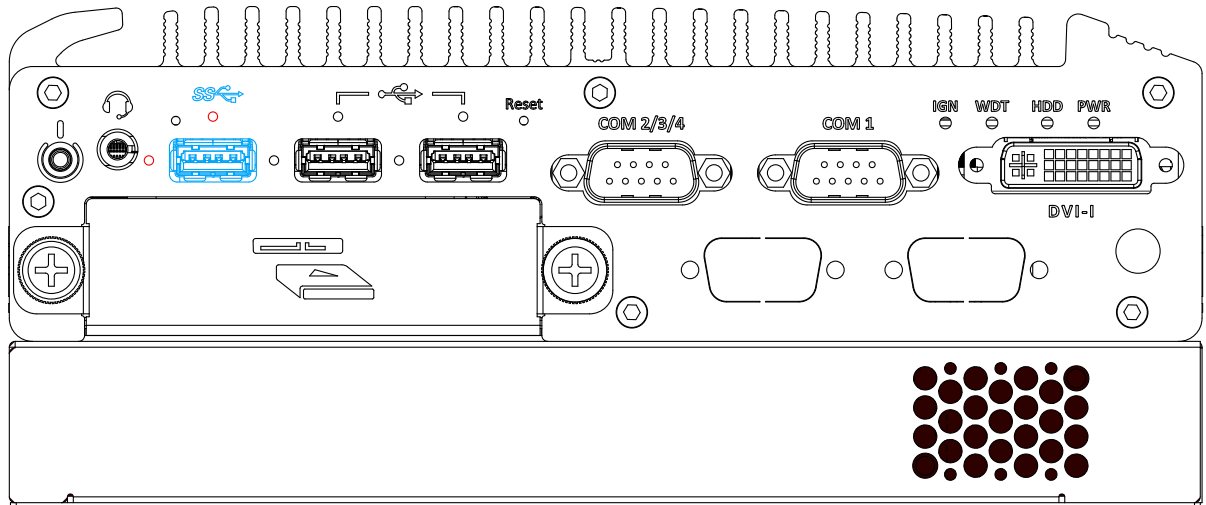

The system offers one USB3.1 Gen1 (SuperSpeed USB) port on its front panel with screw-lock mechanism (indicated in **red**). It is backward-compatible with USB 2.0, USB 1.1 and USB 1.0 devices. Legacy USB support is also provided so you can use USB keyboard/mouse in DOS environment while USB 3.1 Gen1 driver is supported natively in Windows 10.

### 2.2.5 USB2.0 Port

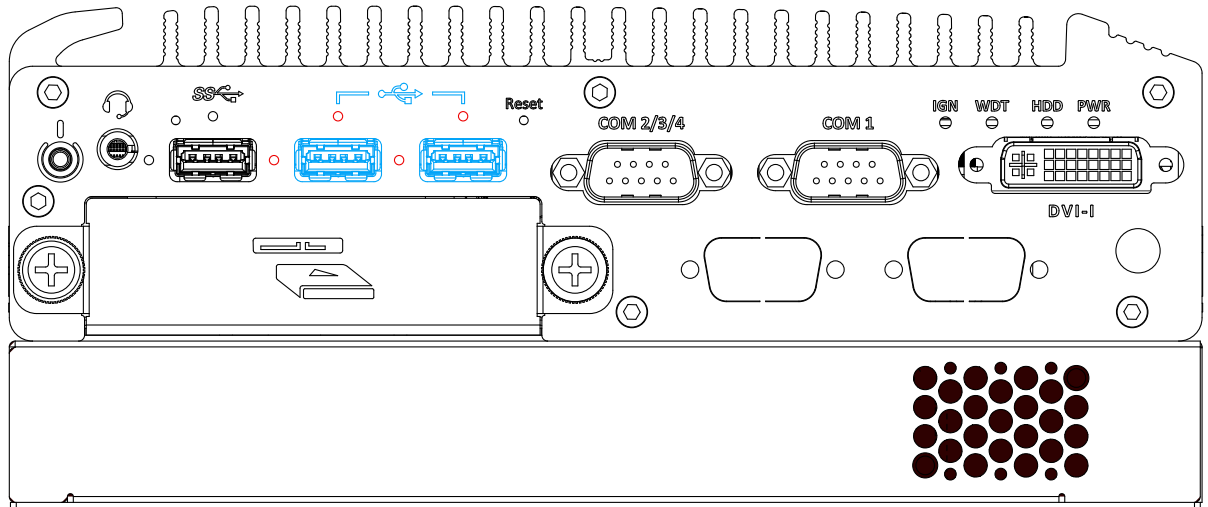

The system offers two USB2.0 ports on its front panel with screw-lock mechanism (indicated in red). They are backward-compatible with USB 1.1 and USB 1.0 devices. Legacy USB support is also provided so you can use USB keyboard/mouse in DOS environment.

### 2.2.6 Reset Button

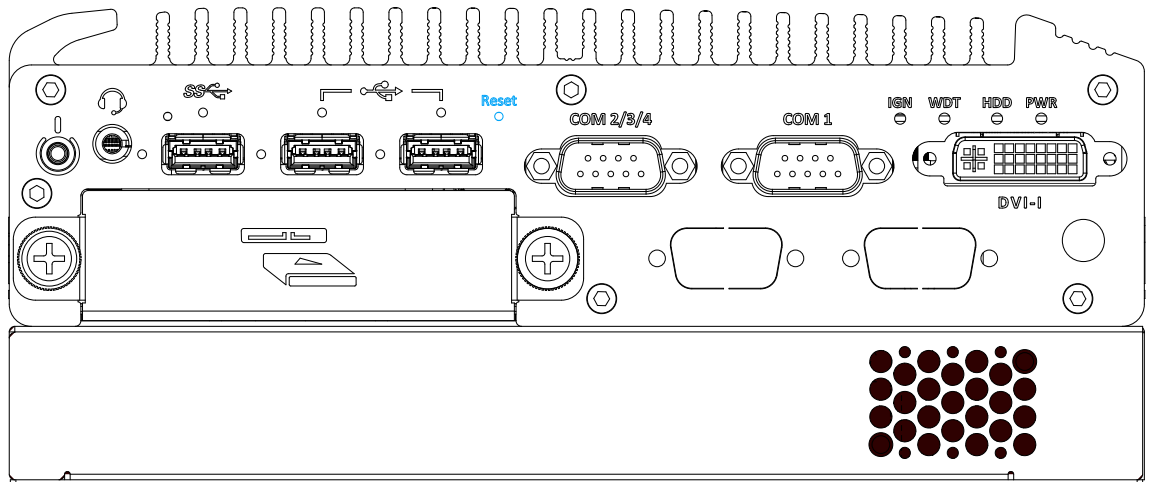

The reset button can be used to manually reset the system in case of abnormal condition. To avoid unexpected operation, the reset button is hidden behind the front panel. You need to use a pin-like object to push the reset button.



## 2.2.7 COM Ports (COM2/ COM3/ COM4)

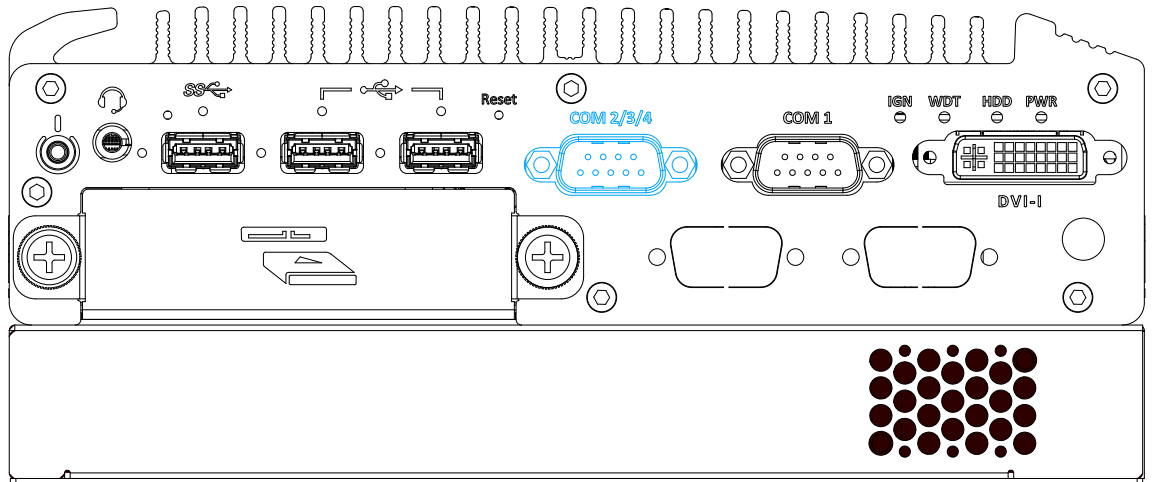

Implemented using industrial-grade ITE8786 Super IO chip (-40 to 85°C) and provide up to 921600 bps baud rate, the second D-Sub male connector (COM2/ 3/ 4) can be configured in BIOS as single RS-422/ 485 port (COM2) or three 3-wire RS-232 ports (COM2/COM3/COM4). Please refer to [COM2/ 3/ 4 Port Configuration](#) for configuring operation mode. An optional 1-to-3 Y-cable is available to connect three RS-232 devices.

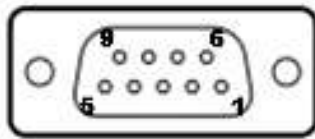

**COM2/ 3/ 4 Pin**



**1-to-3 Y-cable**

The following table describes the pin definition of the COM port

	3-port RS-232 COM2/ 3/ 4		
Pin#	COM2	COM3	COM4
1			
2	RX		
3	TX		
4		TX	
5	GND	GND	GND
6		RX	
7			TX
8			RX
9			

	Single port RS-422/ 485	
Pin#	RS-422	RS-485
1		
2	TxD+	TxD+/RxD+
3	RxD+	
4	RxD-	
5	GND	GND
6		
7		
8	TxD-	TxD-/RxD-
9		

## 2.2.8 COM 1 Port

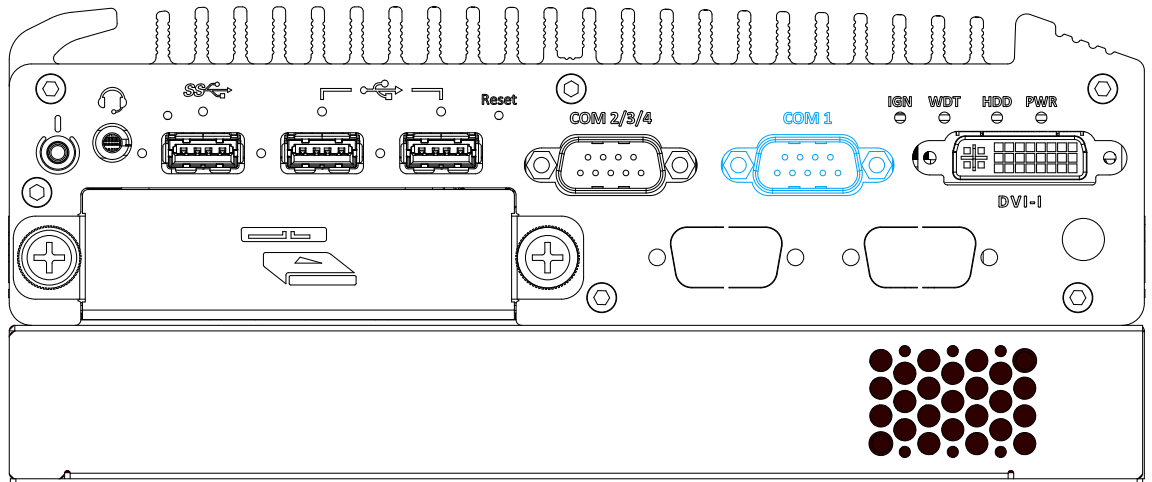

Isolated with up to 15kV ESD protection, the port is implemented using industrial-grade ITE8786 Super IO chip (-40 to 85°C) and provides up to 921600 bps baud rate. COM1 is aRS-485 port via 9-pin D-Sub male connector. The following table describes the pin definition of COM ports.

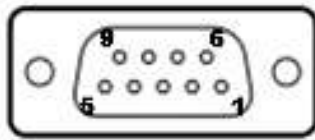

COM1	
Pin#	RS-485 Mode
1	
2	485 TXD+/RXD+
3	
4	
5	GND
6	
7	
8	485 TXD-/RXD-
9	

## 2.2.9 System Status LED

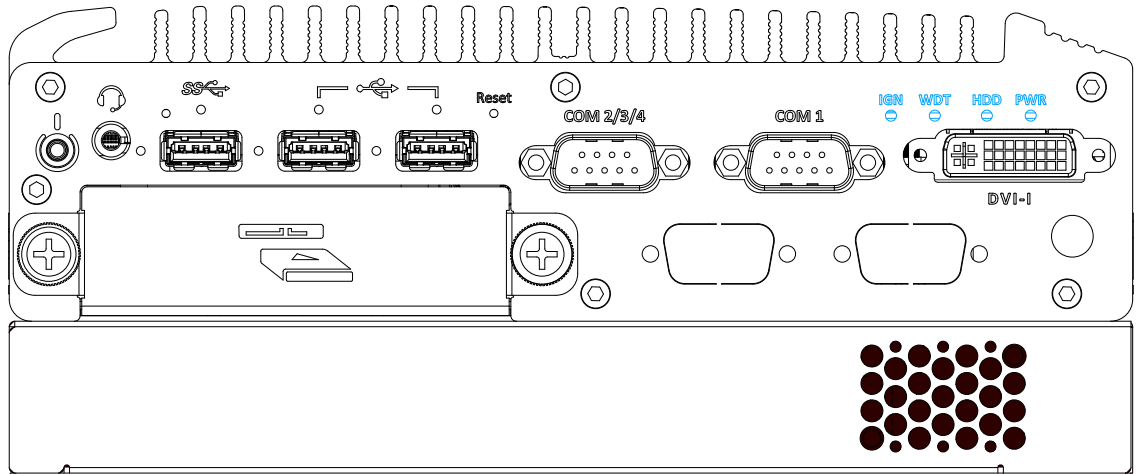

There are four LED indicators on the I/O panel: PWR, WDT, HDD and IGN. The descriptions of these LEDs are listed in the following table.

Indicator	Color	Description
IGN	Yellow	Ignition signal indicator, lid when IGN is high (12V/ 24V).
WDT	Yellow	Watchdog timer LED, flashing when watchdog timer is started.
HDD	Red	Hard drive indicator, flashing when SATA HDD is active.
PWR	Green	Power indicator, lid when system is on.

### 2.2.10 DVI-I Port

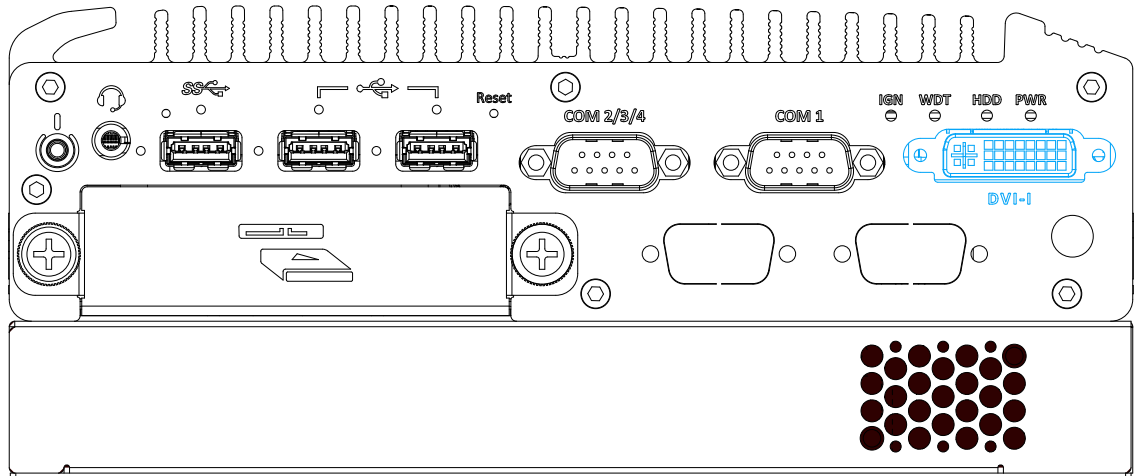

The system features a DVI-I connector on its front panel that is also compatible with VGA signals. The DVI and VGA outputs are directly driven by integrated Intel HD graphics engine and support up to 1920 x 1080 resolution.

For VGA monitor, Neosys offers a specialized DVI-to-VGA adapter as an accessory shipped with the system. This adapter supports VGA DDC signals and thus eliminates compatibility issues with VGA monitors. Or you can use a DVI-I to VGA+DVI-D Y-cable to support two independent display outputs



**DVI to VGA  
adapter**

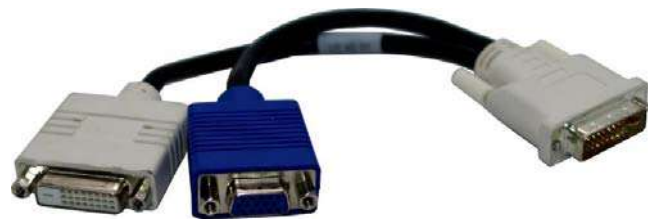

**Optional DVI to VGA+DVI Y-cable**

## 2.3 Rear Panel I/O

On the rear panel of the system, you will find a 3-pin terminal block for DC input with ignition power control, a power LED with remote on/ off control, four M12 X-coded connectors, and a 15-pin DIO port.

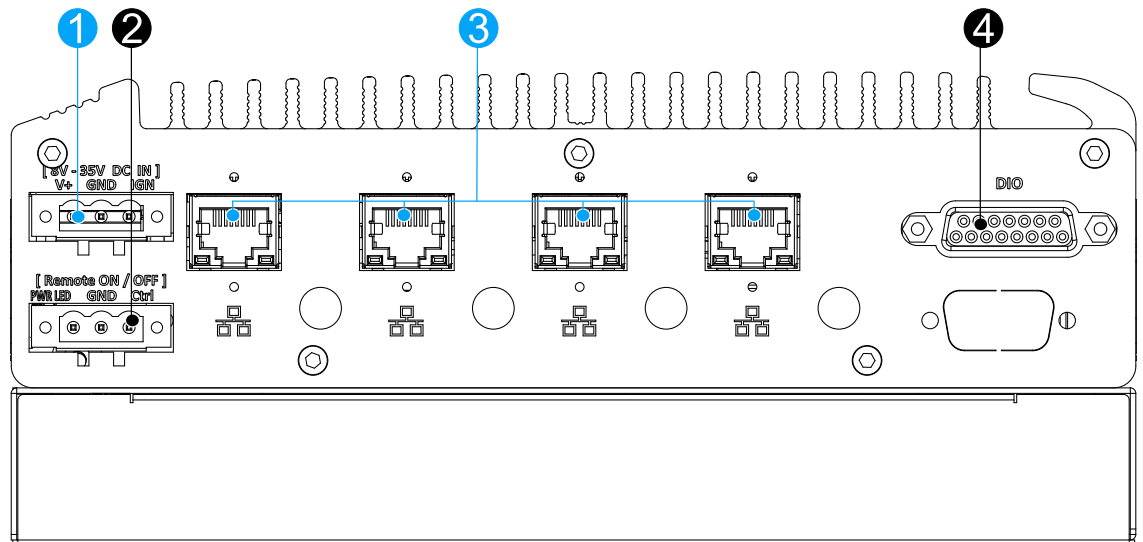

No.	Item	Description
1	<a href="#">3-pin terminal block (DC/ ignition input)</a>	Compatible with DC power input from 8-35V, the terminal block is also used for ignition signal input.
2	<a href="#">3-pin Remote on/off control</a>	Allows for external switch extension when the system is placed inside a cabinet.
3	<a href="#">RJ45 Power over Ethernet ports (Optional)</a>	The RJ45 Power over Ethernet (PoE) ports provide both data connection and electric power to devices (eg. IP camera).
4	<a href="#">Isolated DIO port</a>	The DIO port provides 4x isolated digital input and 4x isolate output channels

### 2.3.1 3-pin Terminal Block DC Input/ Optional Ignition Control

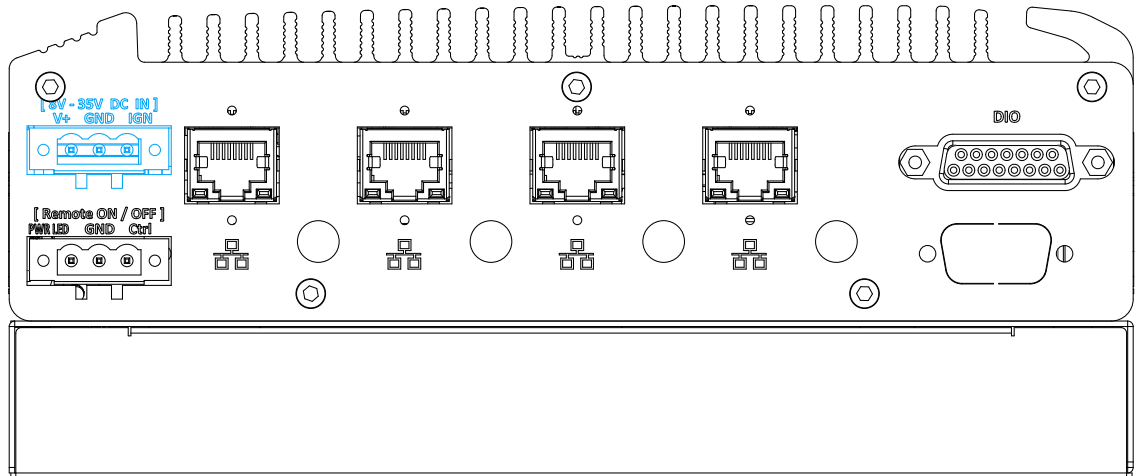

The system accepts a wide range of DC power input from 8 to 35V via a 3-pin pluggable terminal block, which is fit for field usage where DC power is usually provided. The screw clamping mechanism on the terminal block offers connection reliability when wiring DC power.

In addition to DC power input, this terminal block can also accept optional ignition signal input (IGN).

 **WARNING**

*Please make sure the voltage of DC power is correct before you connect it to the system. Supplying a voltage over 35V will damage the system.*

### 2.3.2 3-pin Remote On/ Off

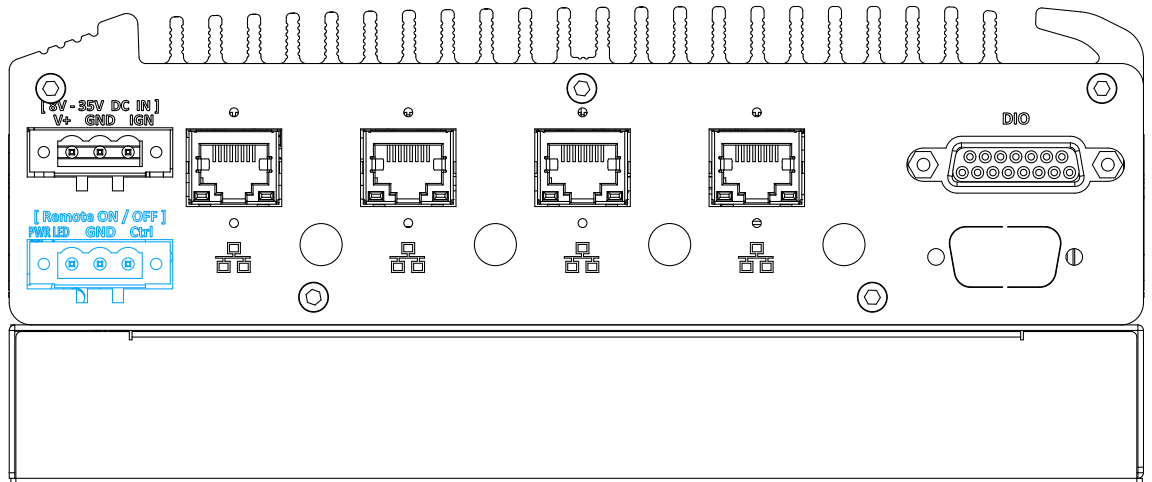

The “Remote On/ Off” 3-pin connection allows for external switch extension. It is useful when the system is placed in a cabinet or a not easily accessed location. You may connect an external remote with an external status LED indicator (15mA) by connecting to PWR LED and GND.

### 2.3.3 RJ45 Power over Ethernet Port (Optional)

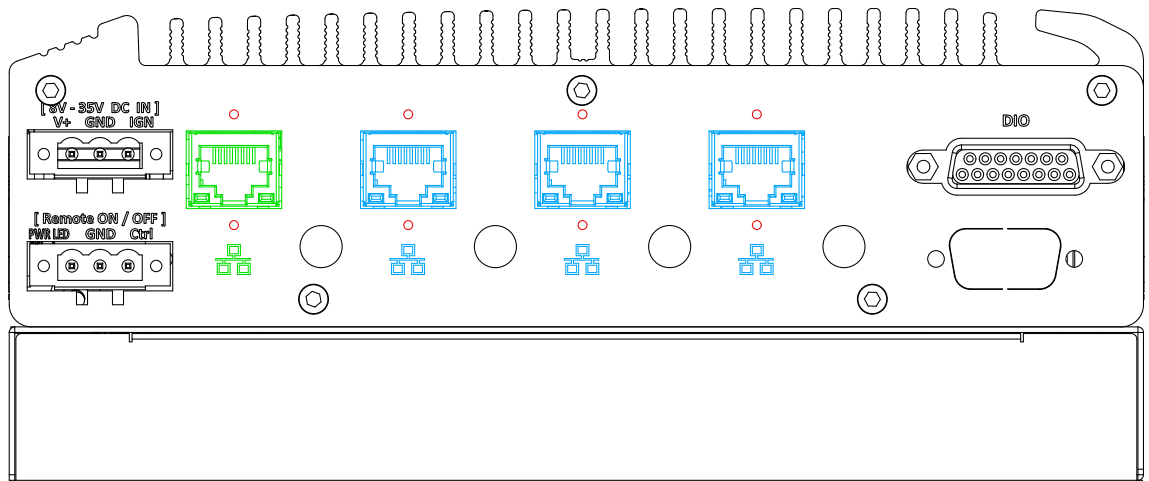

The system offers four PoE+ GbE ports via RJ45 connectors on the rear panel. The ports are implemented using Intel® I210 controller and the port indicated in green supports Wake-on-LAN.

Power over Ethernet (PoE) supplies electrical power and data on a CAT-5/CAT-6 Ethernet cable. Acting as a PoE PSE (Power Sourcing Equipment), compliant with IEEE 802.3at, each PoE port delivers up to 25.5W to a Powered Device (PD). PoE can automatically detect and determine if the connected device requires power or not, so it is compatible with standard Ethernet devices as well. Each port has one dedicated PCI Express link for maximum network performance.

#### Active/Link LED (Right)

LED Color	Status	Description
Orange	Off	Ethernet port is disconnected
	On	Ethernet port is connected and no data transmission
	Flashing	Ethernet port is connected and data is transmitting/receiving

#### Speed LED (Left)

LED Color	Status	Description
Off, Green or Orange	Off	10 Mbps
	Green	100 Mbps
	Orange	1000 Mbps



### 2.3.4 Isolated Digital Input/ Output

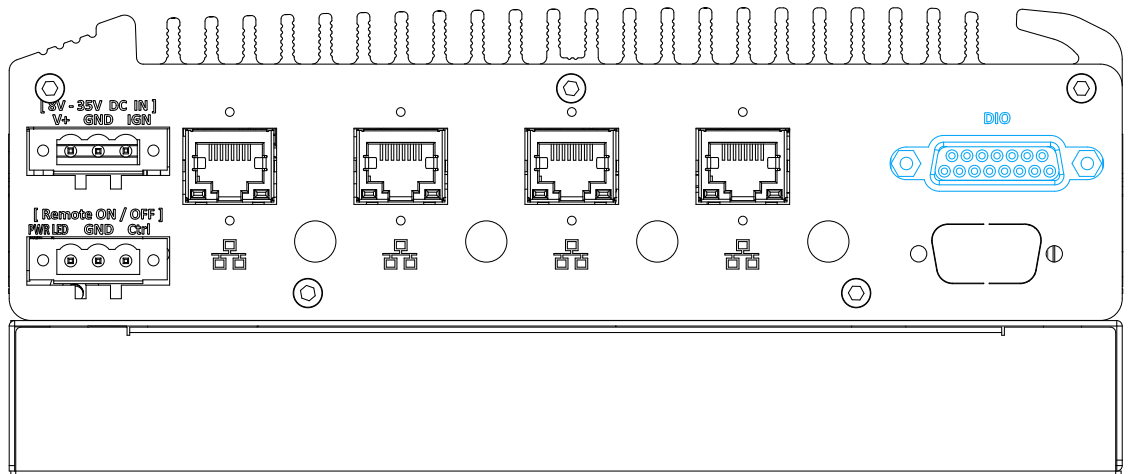

The system provides 4x isolated digital input channels and 4x isolated digital output channels. The DIO functions support polling mode I/O access and DI change-of-state interrupt. Please refer to [Watchdog Timer & Isolated DIO](#) for information on wiring and programming the isolated DIO channels.

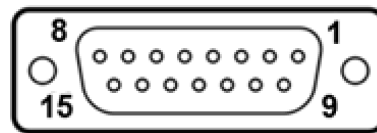

Pin#	Pin Definition	Pin#	Pin Definition
1	DI_0	9	DI_GND
2	DI_1	10	DI_2
3	DI_GND	11	DI_3
4	DO_GND	12	DO_GND
5	DO_0	13	DO_2
6	DO_1	14	DO_3
7	DO_GND	15	-
8	VDD		

## 2.4 Internal I/O Functions

In addition to I/O connectors on the front panel, the system also provides internal on-board expansion slots. In this section, we'll illustrate these internal I/O functions.

### 2.4.1 M.2 2280 (SATA Signal Only) Slot for SSD

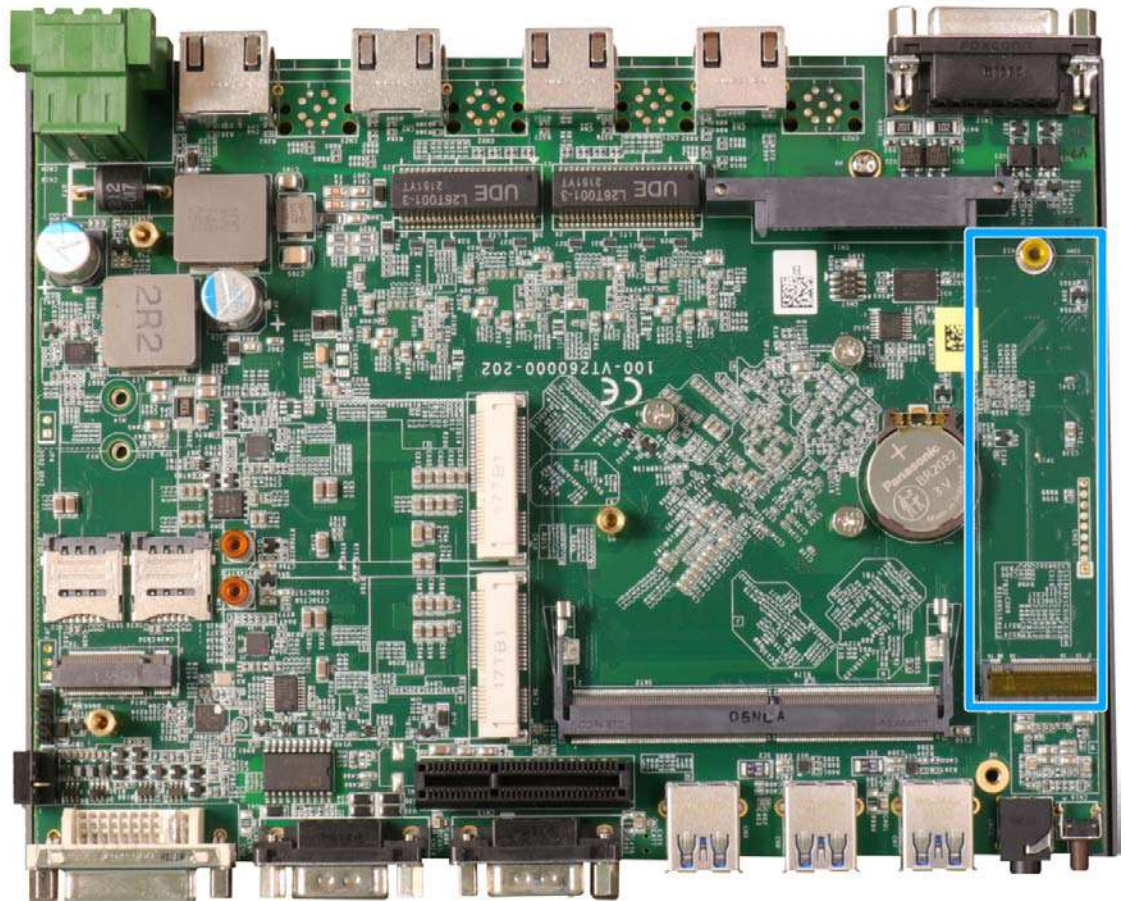

The system has an M.2 2280 slot (SATA signal only) for you to install an M.2 SATA SSD for faster access over traditional hard disk drives.



#### NOTE

*The M.2 slot is only compatible with SATA signal M.2 SSD only.*

M.2 2280M Key Pin Definition

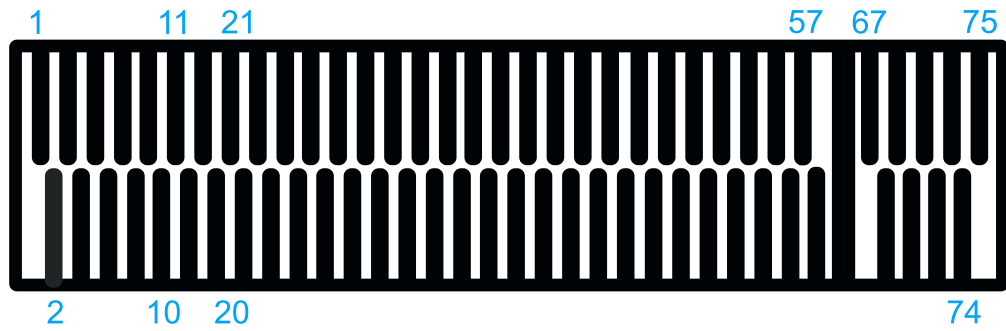

Pin #	Signal	Pin #	Signal
1	GND	2	+3V3
3	GND	4	+3V3
5		6	-
7		8	-
9	GND	10	-
11		12	+3V3
13		14	+3V3
15	GND	16	+3V3
17		18	+3V3
19		20	-
21	GND	22	-
23		24	-
25		26	-
27	GND	28	-
29		30	-
31		32	-
33	GND	34	-
35		36	-
37		38	-
39	GND	40	-
41	SATA-B+	42	-
43	SATA-B-	44	-
45	GND	46	-
47	SATA-A-	48	-
49	SATA-A+	50	-
51	GND	52	-
53		54	-
55		56	-
57	GND	58	-
<b>Mechanical Key</b>			
67	-	68	SUSCLK
69	PEDET	70	+3V3
71	GND	72	+3V3
73	GND	74	+3V3
75	GND		

## 2.4.2 DRAM SO-DIMM Slot

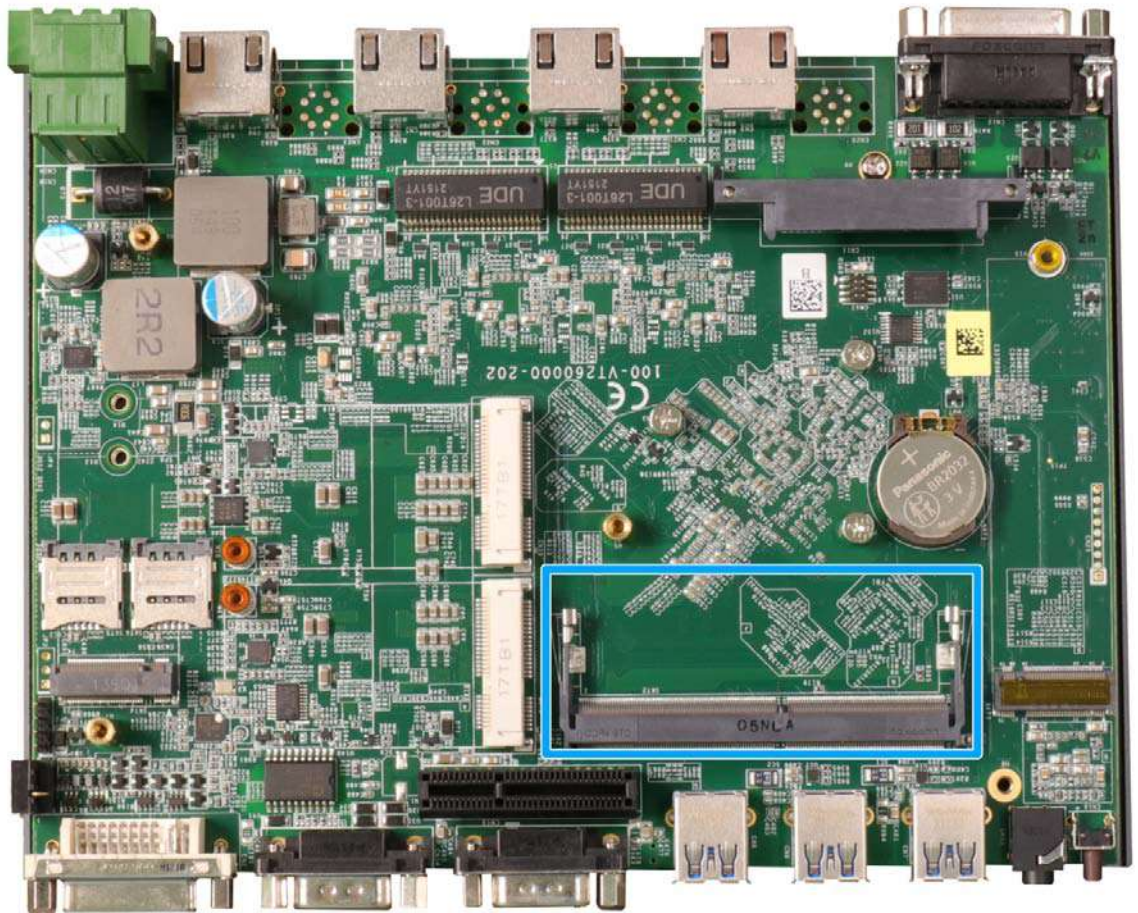

The system motherboard supports a SODIMM socket for installing a DDR4-3200 memory module up to 32GB capacity.

### 2.4.3 Mini-PCle Slot (USB2.0 Signal Only)

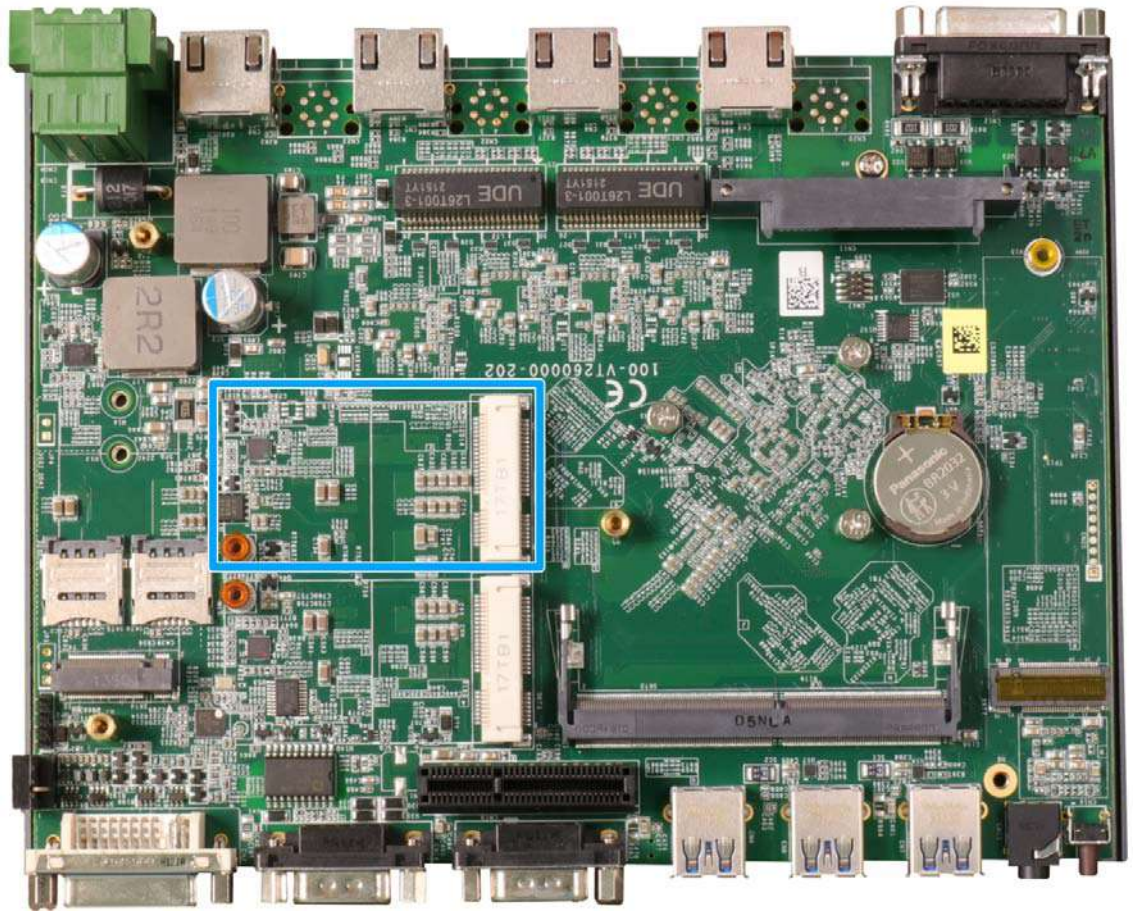

There is a full-size USB2.0 signal only mini-PCle socket for better compatibility with off-the-shelf mini-PCle wireless modules. For customers who want to install a mini-PCle wireless module, please take advantage of the mini-PCle socket and the antenna openings on the panels.

The multiple antenna apertures can be located on the front and rear panel.

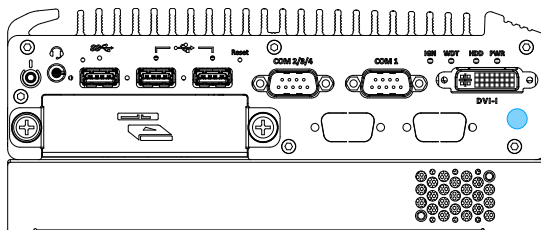

Front panel antenna opening

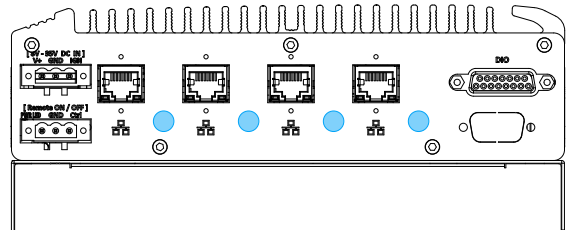

Rear panel antenna opening

**mini-PCle Pin Definition**

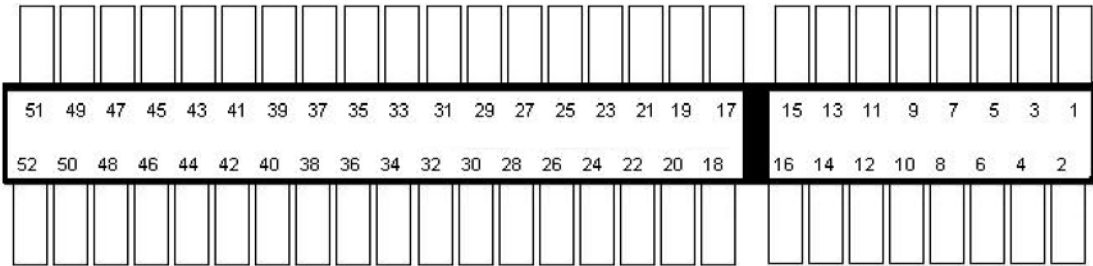

Pin #	Signal	Pin #	Signal
1	-	2	+3.3Vaux
3	-	4	GND
5	-	6	+1.5V
7	-	8	-
9	GND	10	-
11	-	12	-
13	-	14	-
15	GND	16	-
<b>Mechanical Key</b>			
17	-	18	GND
19	-	20	W DISABLE#
21	GND	22	PERST#
23	-	24	+3.3Vaux
25	-	26	GND
27	GND	28	+1.5V
29	GND	30	Reserved
31	-	32	Reserved
33	-	34	GND
35	GND	36	USB D-
37	GND	38	USB D+
39	+3.3Vaux	40	GND
41	+3.3Vaux	42	-
43	GND	44	-
45	Reserved	46	-
47	Reserved	48	+1.5V
49	Reserved	50	GND
51	Reserved	52	+3.3Vaux

### 2.4.4 Mini-PCIe Slot (PCIe and USB2.0 Signal)

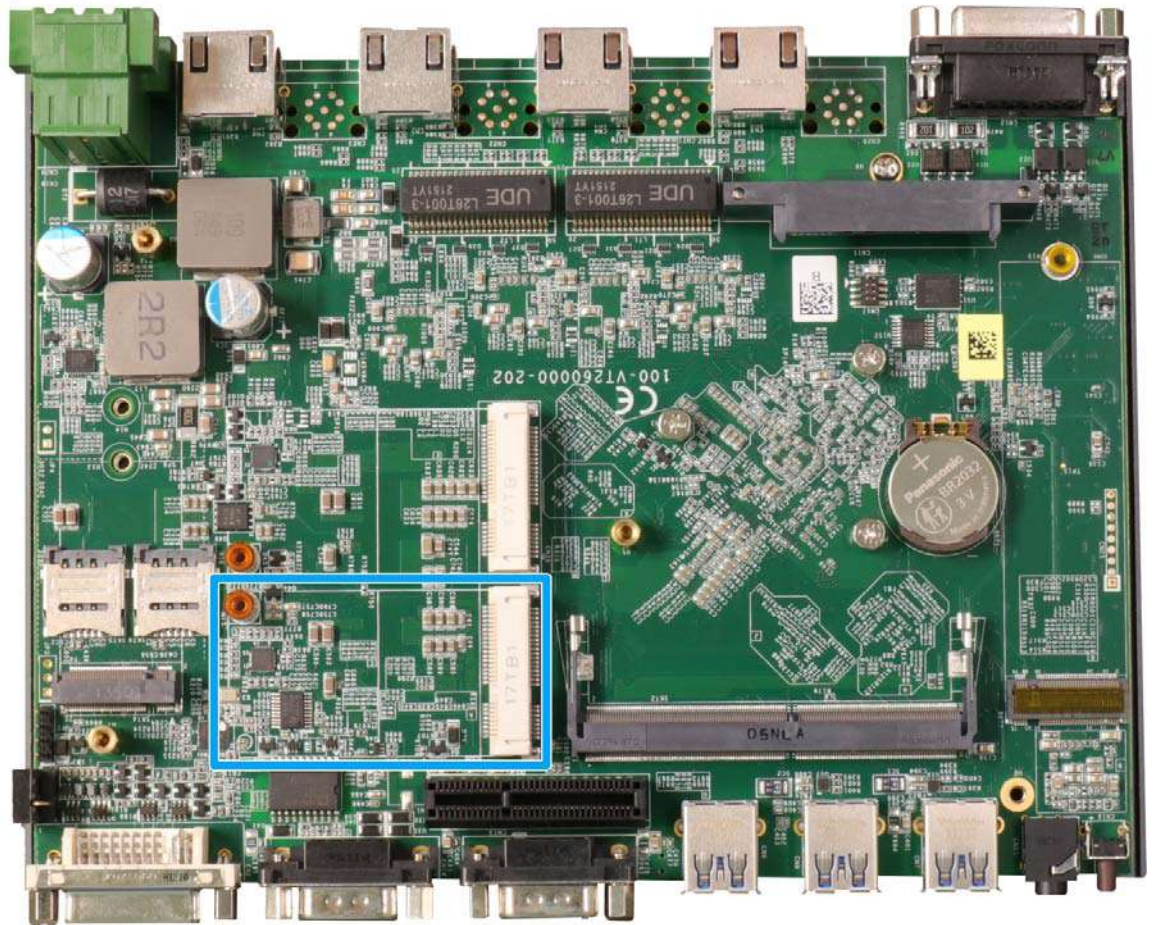

The mini-PCIe socket (in blue) accepts off-the-shelf mini-PCIe modules. You can add additional features to your system such as 5G/ 4G, WiFi, GPS, CAN bus, analog frame grabber, etc.

The multiple antenna apertures can be located on the front and rear panel.

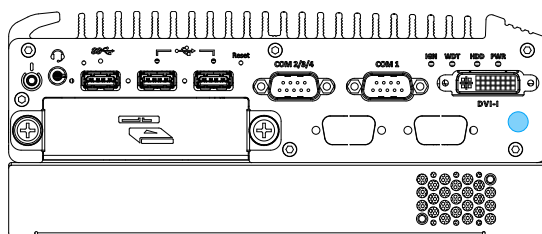

Front panel antenna opening

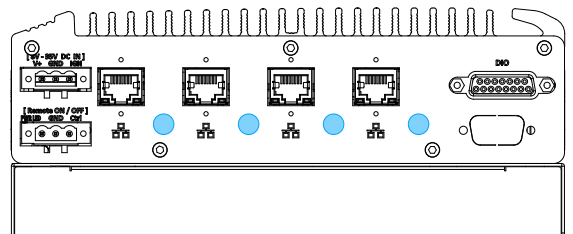

Rear panel antenna opening

**mini-PCle Pin Definition**

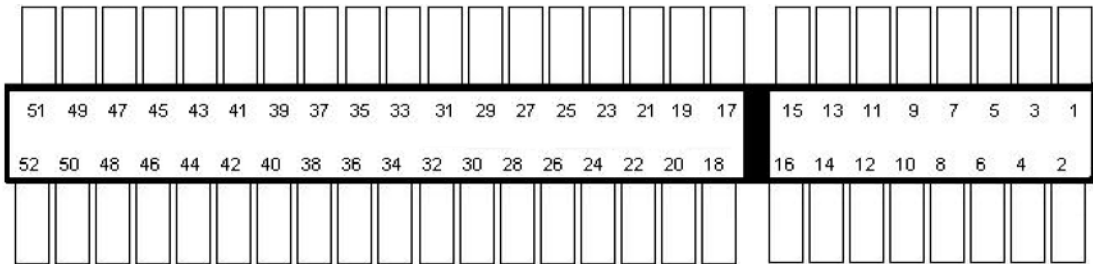

Pin #	Signal	Pin #	Signal
1	-	2	+3.3Vaux
3	-	4	GND
5	-	6	+1.5V
7	-	8	-
9	GND	10	-
11	REFCLK-	12	-
13	REFCLK+	14	-
15	GND	16	-
<b>Mechanical Key</b>			
17	-	18	GND
19	-	20	W_DISABLE#
21	GND	22	PERST#
23	PERn0	24	+3.3Vaux
25	PERp0	26	GND
27	GND	28	+1.5V
29	GND	30	SMB_CLK
31	PETn0	32	SMB_DATA
33	PETp0	34	GND
35	GND	36	USB_D-
37	GND	38	USB_D+
39	+3.3Vaux	40	GND
41	+3.3Vaux	42	-
43	GND	44	-
45	Reserved	46	-
47	Reserved	48	+1.5V
49	Reserved	50	GND
51	Reserved	52	+3.3Vaux

 **WARNING**

*Some off-the-shelf mini-PCle 4G modules are not compliant to standard mini-PCle interface. They use 1.8V I/O signals instead of standard 3.3V I/O and may have signal conflict. Please consult with Neosys for compatibility when in doubt!*



### 2.4.5 M.2 3042/ 3052 B Key Socket

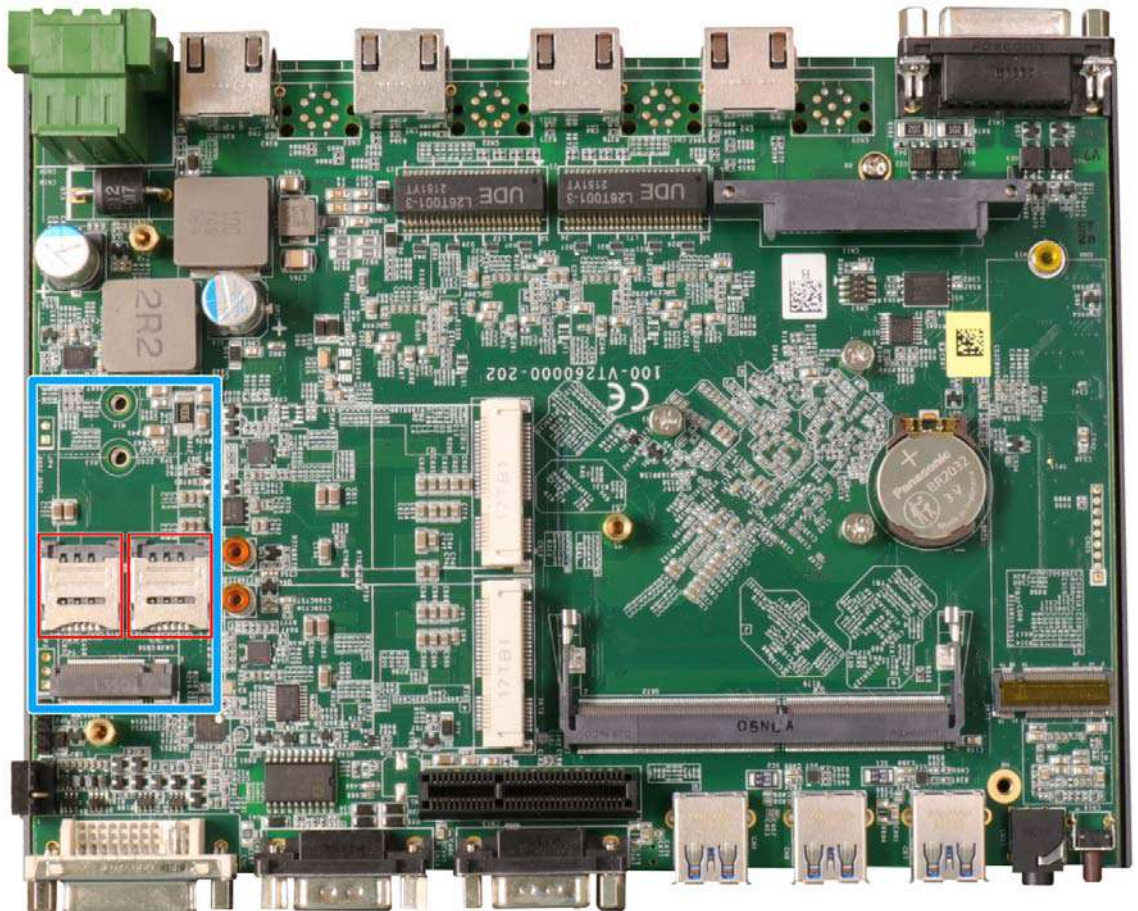

The system has one M.2 3042/ 3052 B key socket (in blue) for 5G/4G module installation and dual SIM slots (in red). The M.2 slot features USB3.1 and USB 2.0 signal.

For SMA antenna installation, there are antenna openings located on the front/ rear panels.

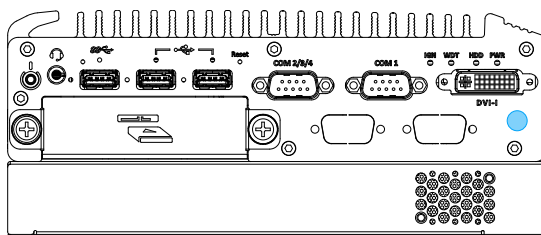

Front panel antenna opening

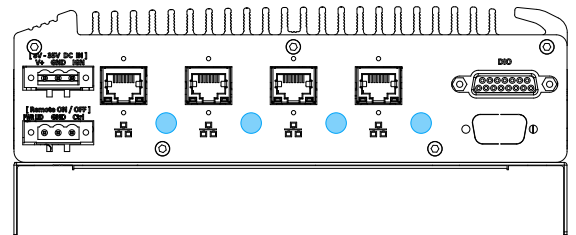

Rear panel antenna opening

M.2 3042/ 3052 B Key Pin Definition

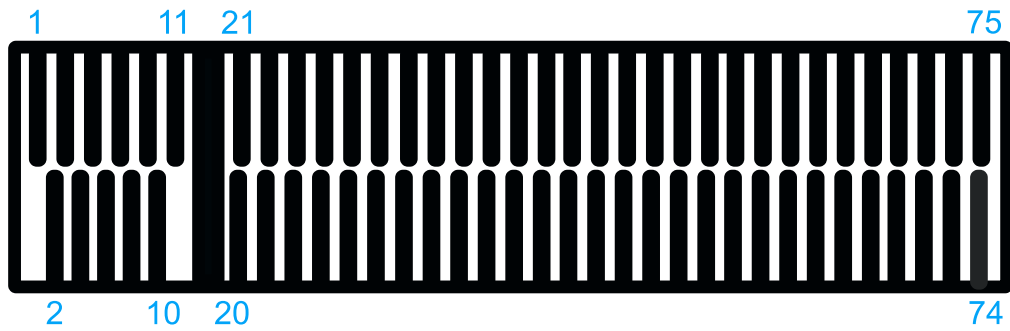

Pin #	Signal	Pin #	Signal
1	-	2	+3V3
3	GND	4	+3V3
5	GND	6	FULL_CARD_POWER_OFF_N
7	USB_D+	8	W_DISABLE_N
9	USB_D-	10	-
11	GND		
<b>Mechanical Key</b>			
21	-	20	-
23	-	22	-
25	-	24	-
27	GND	26	-
29	USB3.0-RX-	28	-
31	USB3.0-RX+	30	UIM1-RESET
33	GND	32	UIM1-CLK
35	USB3.0-TX-	34	UIM1-DATA
37	USB3.0-TX+	36	UIM1-PWR
39	GND	38	-
41		40	
43		42	UIM2-DATA
45	GND	44	UIM2-CLK
47		46	UIM2-RESET
49		48	UIM2-PWR
51	GND	50	PERST_N
53		52	-
55		54	-
57	GND	56	-
59	-	58	-
61	-	60	-
63	-	62	-
65	-	64	-
67	-	66	
69	-	68	-
71	GND	70	+3V3
73	GND	72	+3V3
75	-	74	+3V3

## 2.4.6 Ignition Rotary Switch (Optional)



The optional ignition control features an ignition rotary switch that has multiple modes for pre and post ignition settings. Please refer to the section [Ignition Power Control](#) for details.

### 3 System Installation

Before disassembling the system enclosure and installing components and modules, please make sure you have done the following:

- It is recommended that only qualified service personnel should install and service this product to avoid injury or damage to the system.
- Please observe all ESD procedures at all times to avoid damaging the equipment.
- Before disassembling your system, please make sure the system has powered off, all cables and antennae (power, video, data, etc.) are disconnected.
- Place the system on a flat and sturdy surface (remove from mounts or out of server cabinets) before proceeding with the installation/ replacement procedure.

### 3.1 Disassembling the System

To access system internal components, the system needs to be disassembled. To disassemble the system enclosure, please refer to the procedures below:

1. Turn the system upside-down on a steady surface. Remove the screws indicated and separate the Cassette module from the system's enclosure.



2. Gently wiggle the Cassette module and separate it from the enclosure.



- Remove the screw indicated in **blue** on the rear I/O panel.



- Remove the screws (indicated in **blue**) and thumb screws (indicated in **red**) indicated on the front I/O panel, and remove the faceplate.

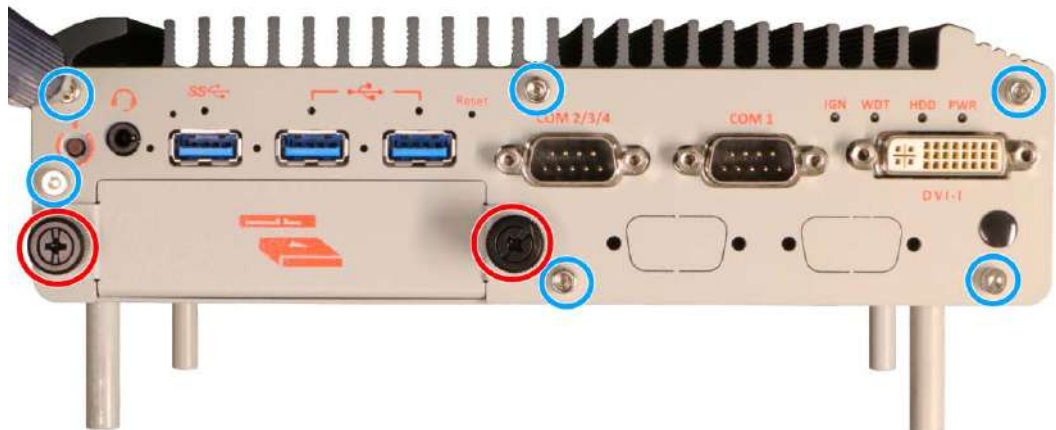

- Remove the screws from both sides of the chassis.



**Left side chassis screws**

**Right side chassis screws**

- Gently slide the U-shaped bottom panel towards the side with the removed panel (the panel with USB ports). Remove the U-shaped bottom panel to access internal expansion slots.

## 3.2 Installing Internal Components

### 3.2.1 DDR4 SO-DIMM Installation

There is a SO-DIMM memory slot on the motherboard that supports up to 32GB DDR4-3200. Please follow the procedures below to replace or install the memory modules.

1. Please refer to the section "[Disassembling the System](#)". Remove the screws indicated.

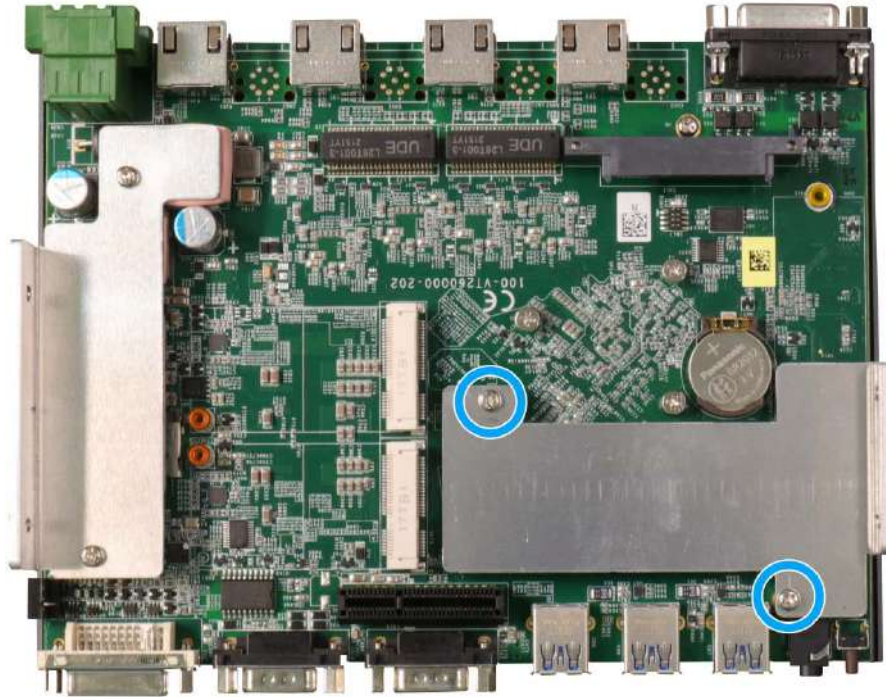

2. Remove the heatsink to locate the SODIMM memory module slot on the motherboard.

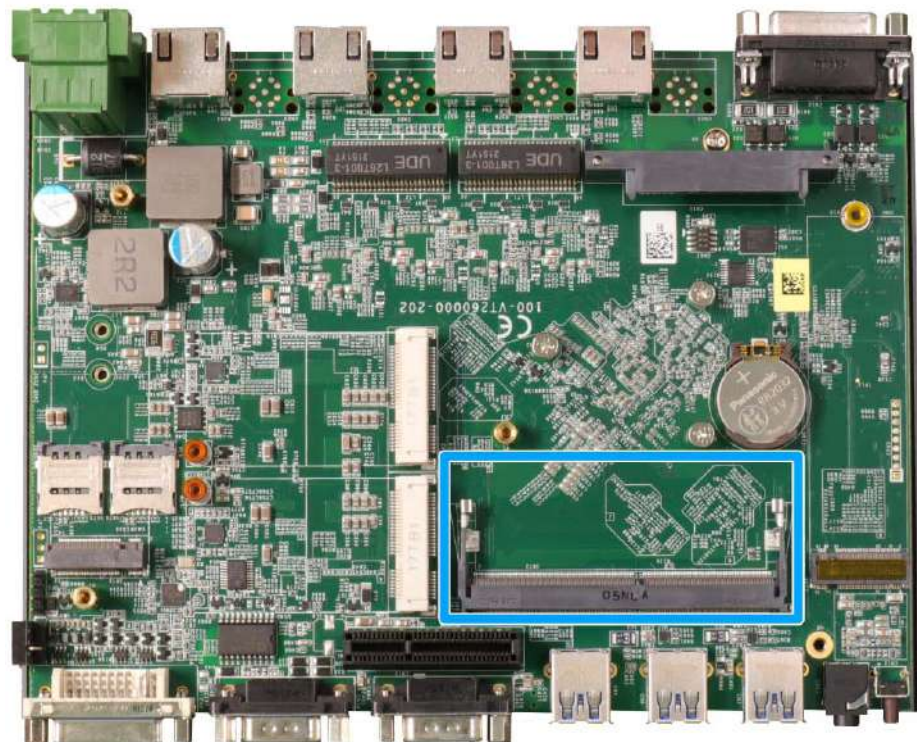

3. To install the memory module, insert gold fingers of the module into the slot at 45 degree angle, push down on the edge of the module and the clips on the side should clip the module into position.

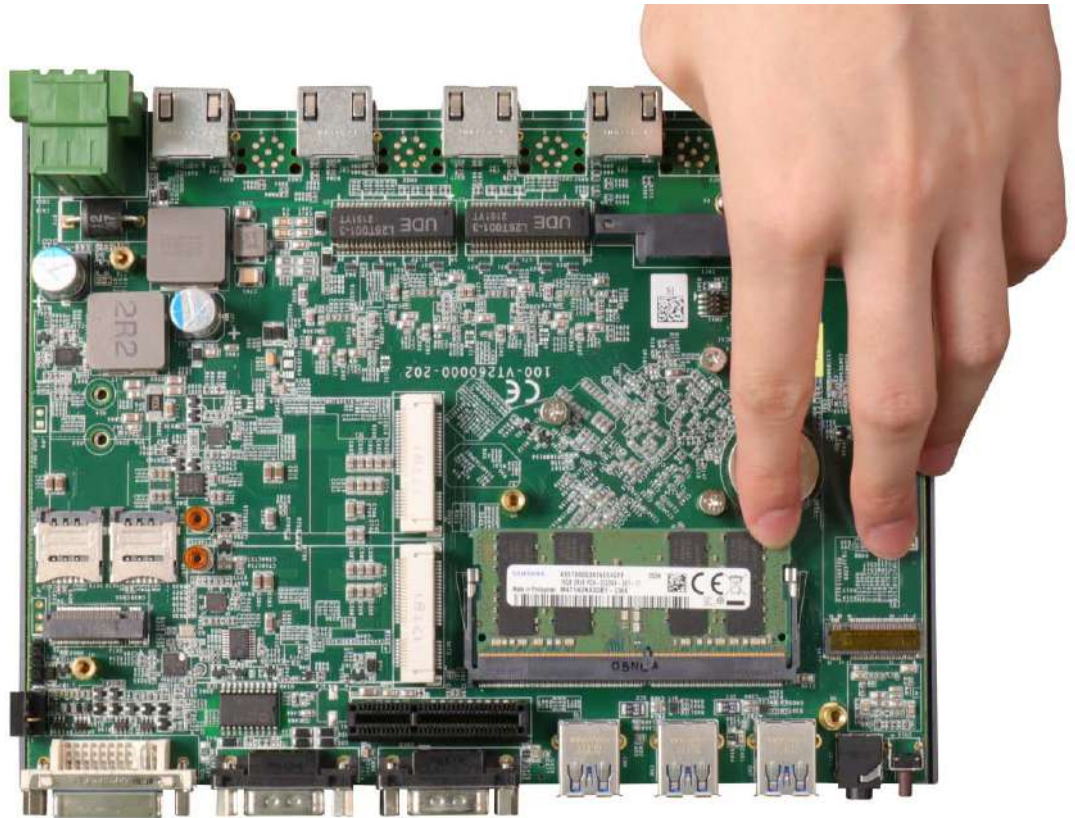

4. Push the memory module down until it is clipped-in.



5. [Reinstall the system enclosure](#) or the panel when done.

If you need to install other components, please refer to respective sections.



### 3.2.2 M.2 2280 SSD Installation

The system has a SATA signal M.2 2280 slot for you to install an M.22280 SATA SSD. For installation, please refer to the following instructions.

1. Please refer to the section "[Disassembling the System](#)".
2. Remove the screws indicated.

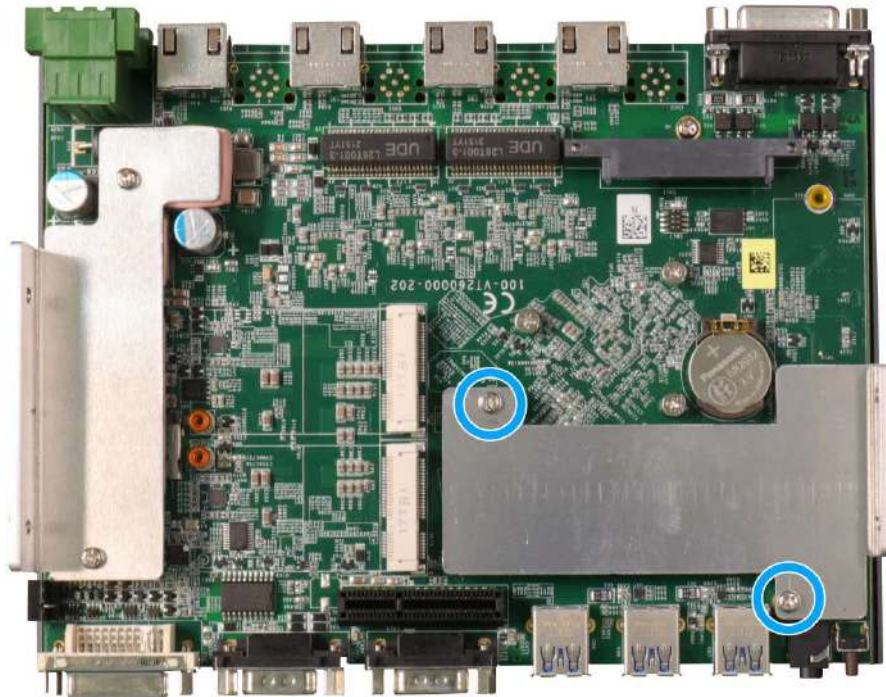

3. Remove the heatsink to access the M.2 slot

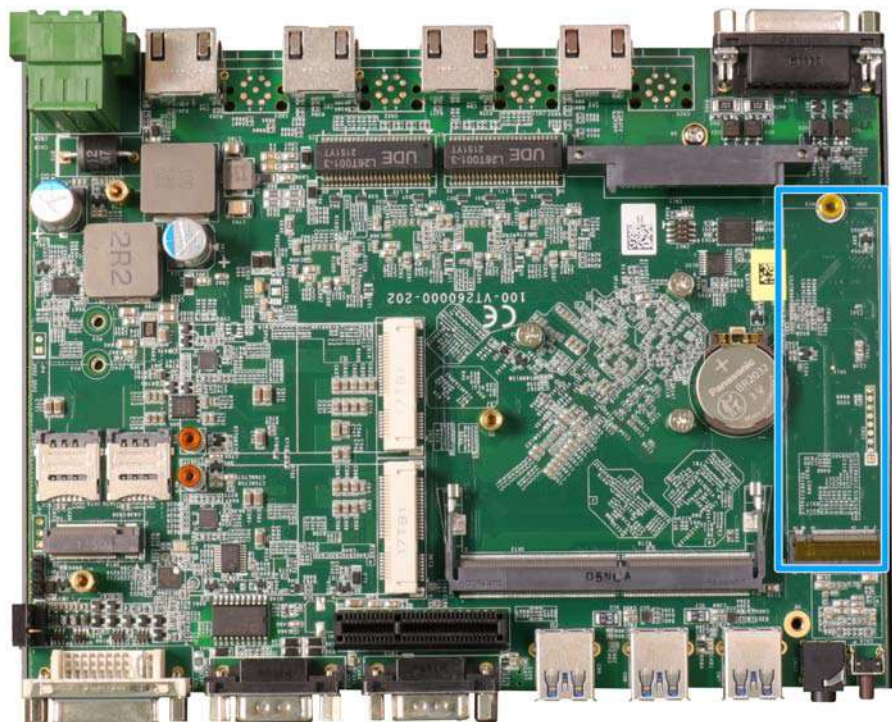

4. Insert the module on a 45 degree angle.



5. Gently press down and secure the module with an M3 P-head screw.



6. [Reinstall the system enclosure](#) or the bottom panel when done.
7. If you need to install other components, please refer to respective sections.

### 3.2.3 M.2 3042/ 3052 B Key Installation

The system has an M.2 3042/ 3052 B key slot (indicated in **blue**) with two corresponding micro-SIM card slots (indicated in **red**). The M.2 slot can be accessed by removing the bottom panel.

1. Please refer to the section "[Disassembling the System](#)".
2. Remove the screws indicated.

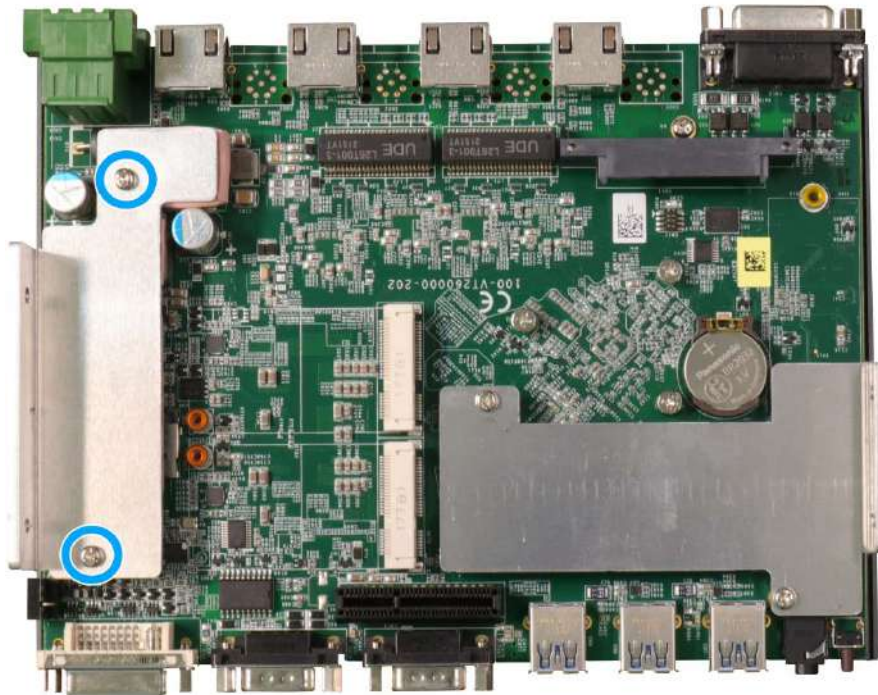

3. Remove the heatsink to access the M.2 3042/ 3052 B key and SIM card slots.

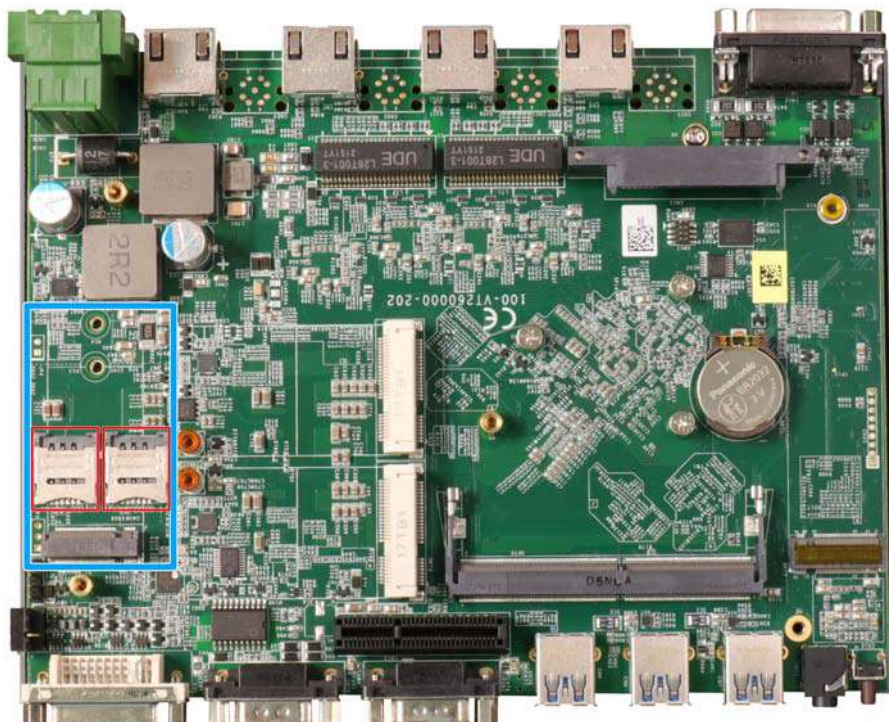

- To install the micro-SIM SIM card, slide the metallic cover in the direction shown and lift it to expose the socket and gold fingers.

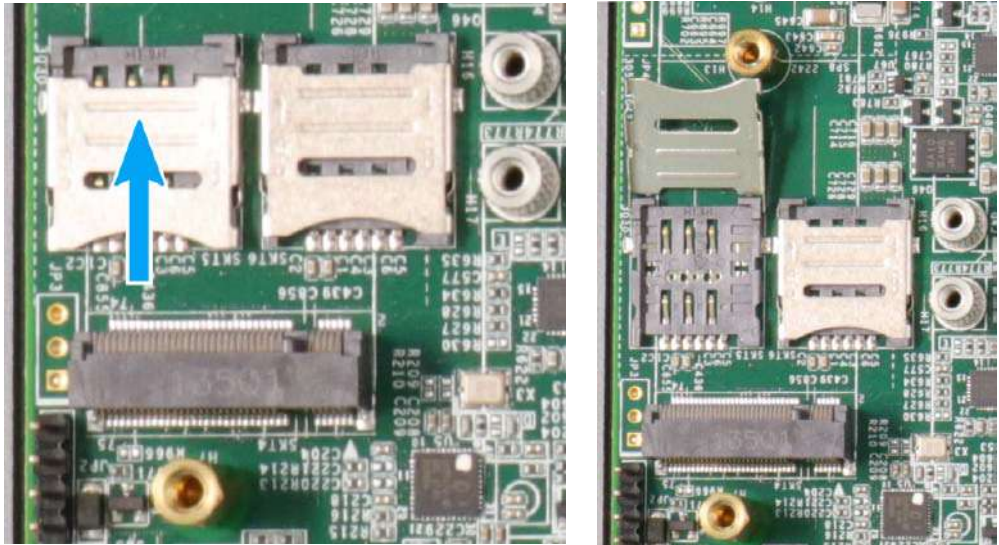

**Slide cover in direction shown**

**Lift the cover with fingertip**

- Gently place the micro-SIM SIM card in the orientation shown, lower the cover and slide the cover in the direction shown to secure the SIM card in place.

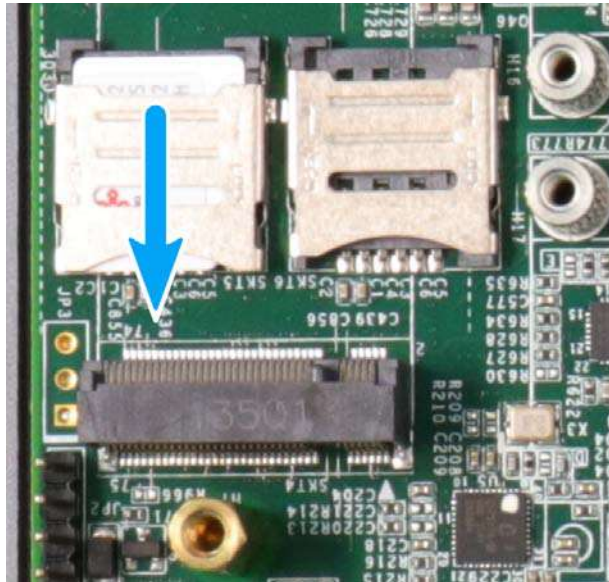

**Place SIM into the socket and slide the cover to secure the micro-SIM**

- To install the M.2 3042/ 3052 module into place, insert the module on a 45° angle into the slot and secure it using the screw provided.

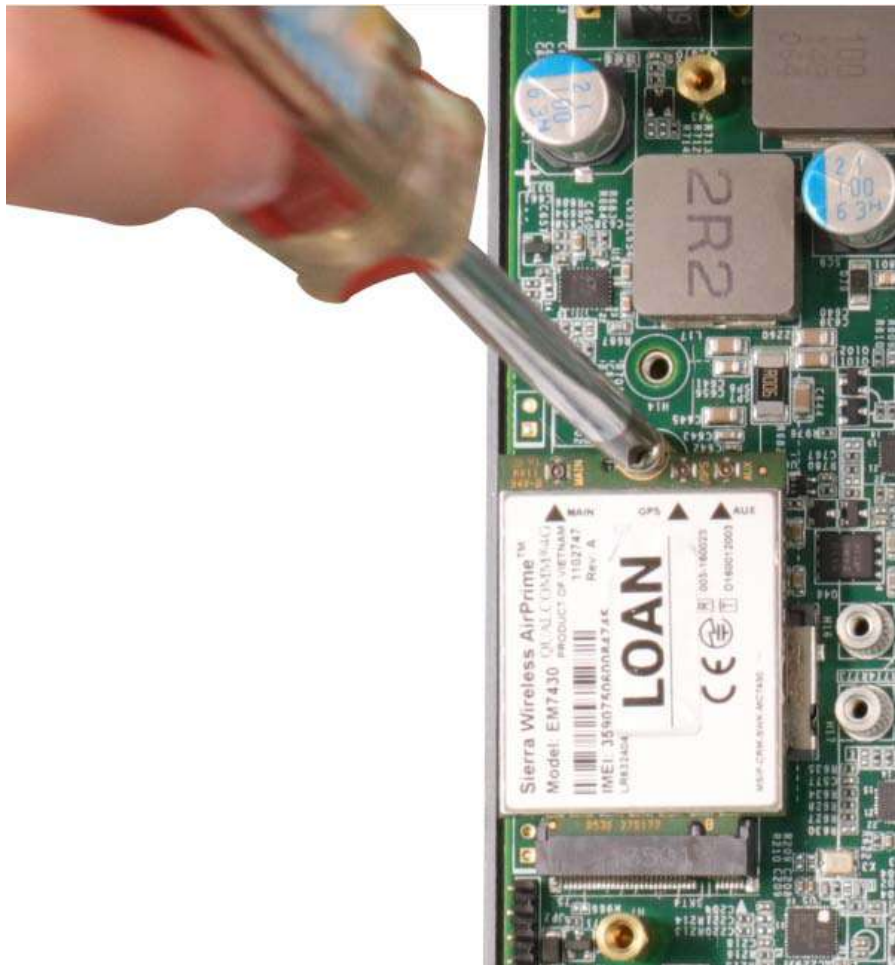

- [Reinstall the system enclosure](#) or the bottom panel when done.
- If you need to install other components, please refer to respective sections.

### 3.2.4 miniPCIe Installation

The system has two miniPCIe sockets, one offers both PCIe and USB2.0 signals (indicated in **red**), while the other offers only USB2.0 signal (indicated in **blue**) for WiFi module installation. The mini PCIe slots can be accessed by removing the bottom panel. Please refer to the section "[Disassembling the System](#)".

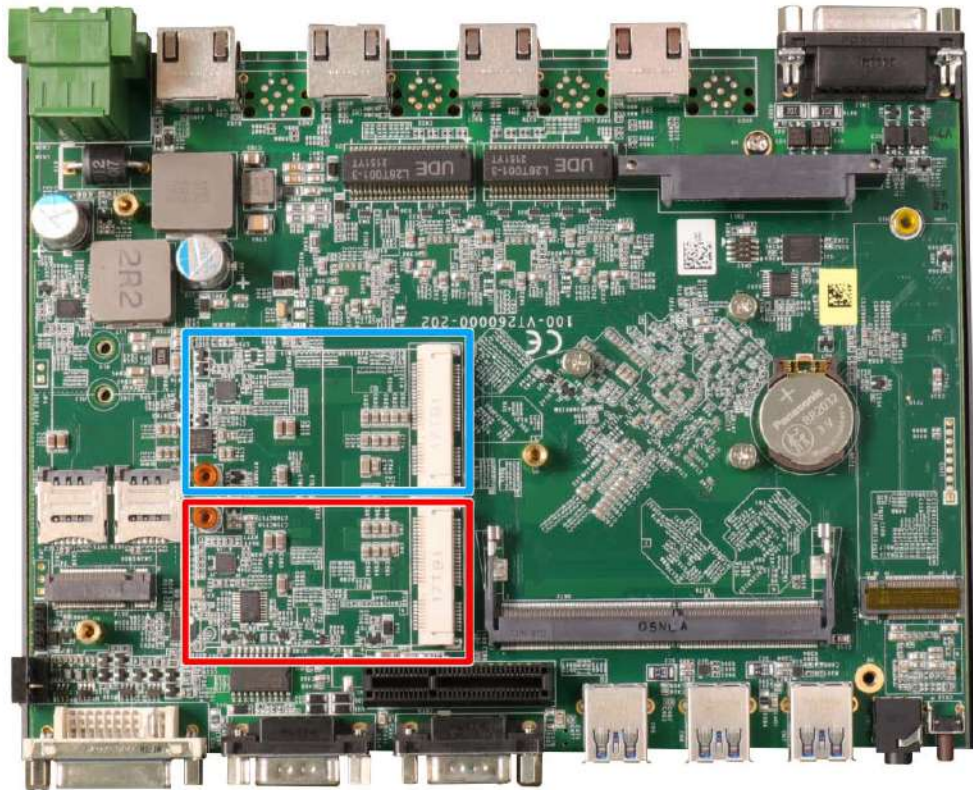

1. To install the mini PCIe module, insert the module on a 45° angle and secure the module using the screw provided.



Insert on a 45° angle and secure using the screw provided

- To install the antenna onto the system enclosure, clip on the IPEZ-to-SMA cable to the module and secure the antenna to the side panel (refer to the module's manual for clip-on connection).



**Clip on the IPEZ-to-SMA cable**

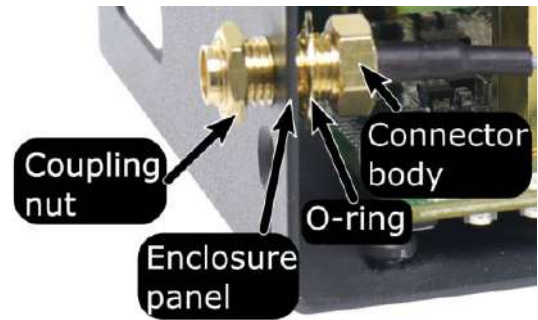

**Secure the connector body, coupling nut onto a antenna opening on a panel**

- [Reinstall the system enclosure](#), panel and external antenna.

If you need to install other components, please refer to respective sections.

### 3.3 Installing the System Enclosure

To install the enclosure, please follow the instructions below.

1. Please make sure heatsinks for DRAM/ M.2 2280 slot and M.2 3042/ 3052 slot are installed (secured with screws indicated) regardless if a module is installed into the slot. follow the steps below:

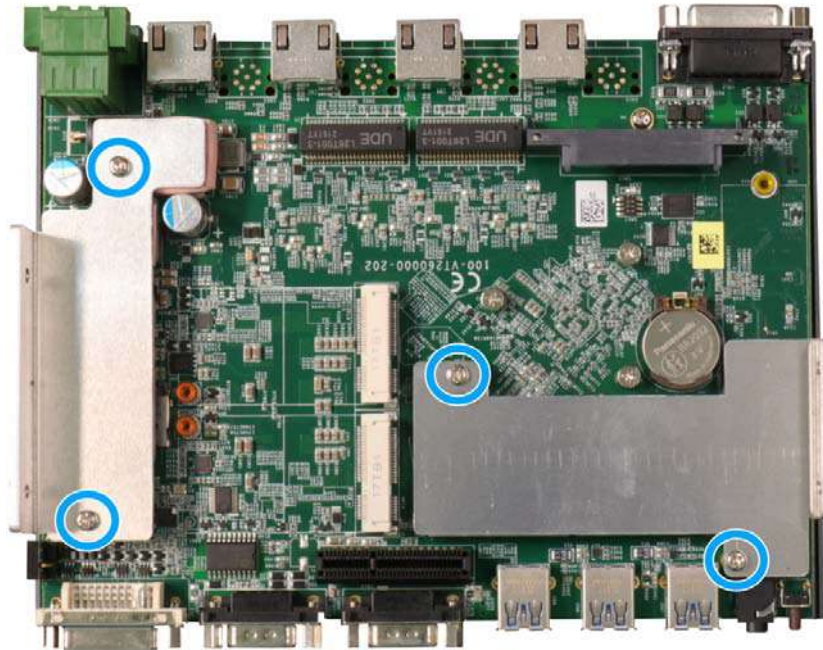

2. Slide bottom U-shape panel to align with the heatsink.





- Secure it with two screws on both sides.



Left side chassis screws

Right side chassis screws

- Place and secure the USB panel with screws (indicated in blue), and insert the 2.5" tray and secure it by tightening the thumb screws (indicated in red).

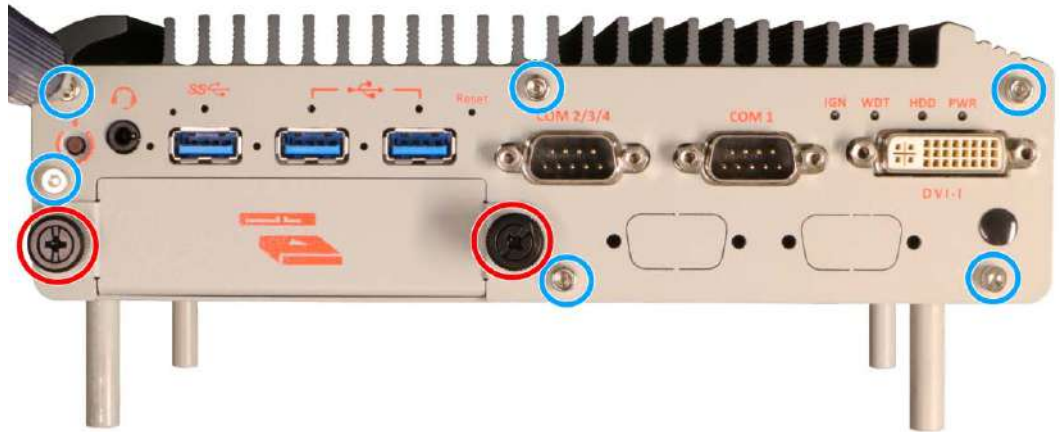

- Secure the screws (indicated in blue) on the M12 connector panel.



6. Turn the system upside-down, place the Cassette module onto the enclosure while ensuring the gold fingers are properly inserted.



7. Secure the Cassette module with the screws indicated.



### 3.4 2.5” Hard Drive/ SSD Installation

To install a 2.5” HDD or SSD in the front accessible tray, please refer to the procedure below.

1. Place the system on a flat sturdy surface, and turn the thumb screws indicated anti-clockwise.



2. Gently pull out the 2.5” HDD/SSD tray. With HDD/SSD label downwards, secure the HDD/ SSD using the screws provided (indicated in blue), there are two screws on each side.

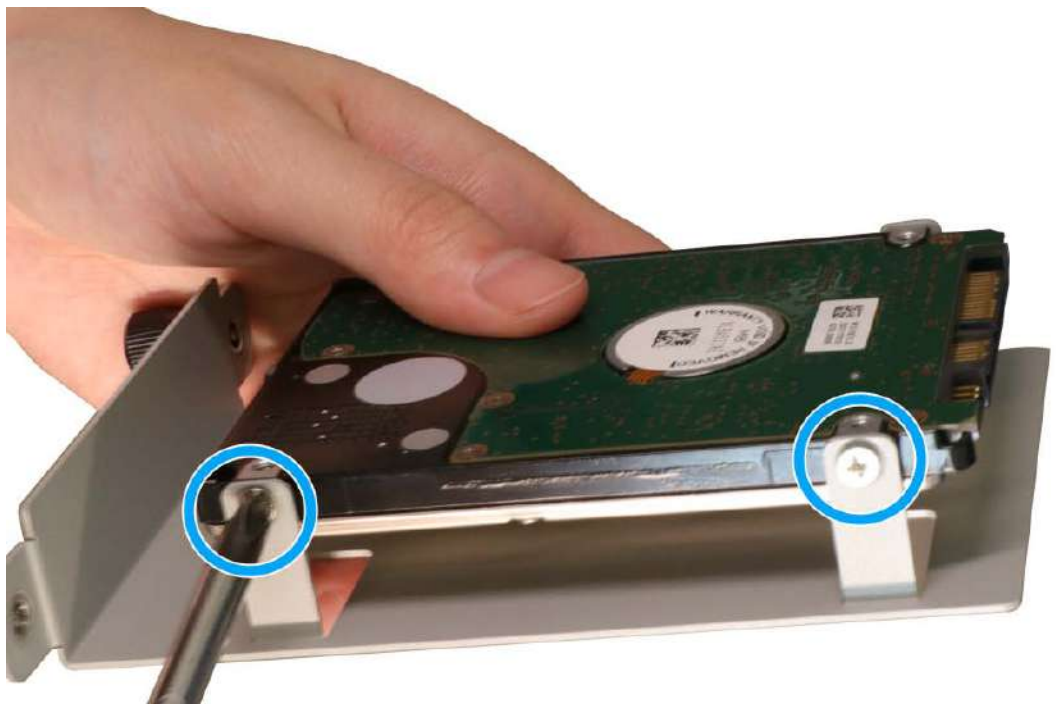

3. Gently insert the tray back into the slot until you feel resistance, and secure the tray by tightening the thumb screws clockwise to complete the installation.



### 3.5 PCIe Add-on Card Installation (Nuvo-2600E Only)

The Nuvo-2600E comes with a Cassette module for you to install a PCIe add-on card to add additional connectivity or functionality. To install, please refer to the following instructions.

1. Place the system on a flat sturdy surface and turn the system upside-down. Remove the four screws indicated.



2. Gently lift and separate the Cassette module from the enclosure.



3. Remove the screw indicated and gently lift and separate the L-shaped panel from the Cassette module.

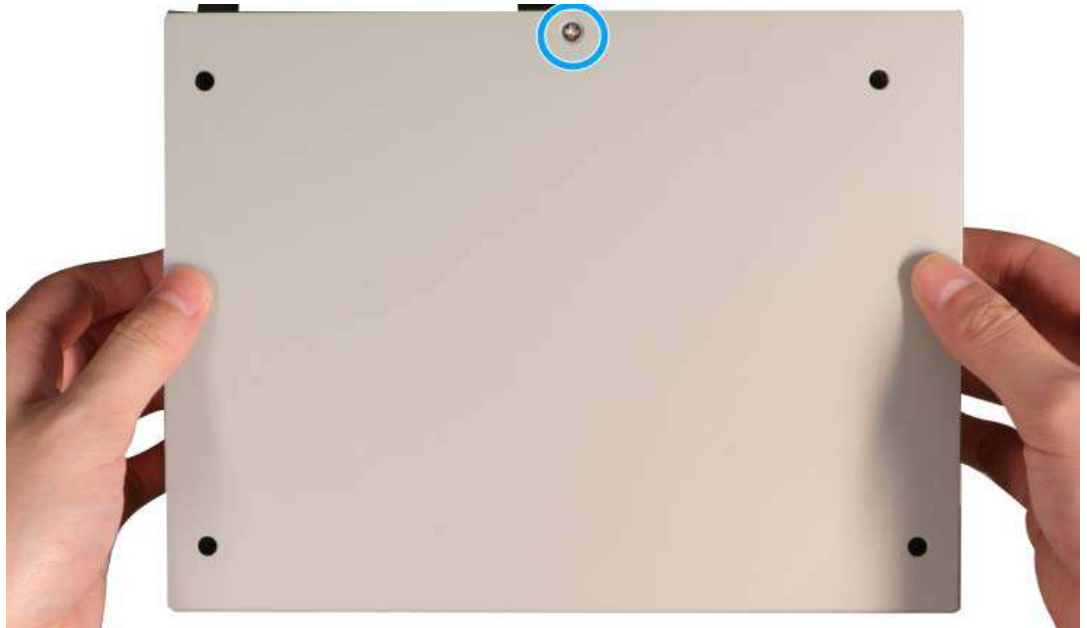

4. Lower the add-on card you wish to install into the Cassette module, make sure the PCIe gold fingers is properly inserted (indicated in **red**), the bottom of the bezel is properly engaged, and the bezel is secured with a screw.

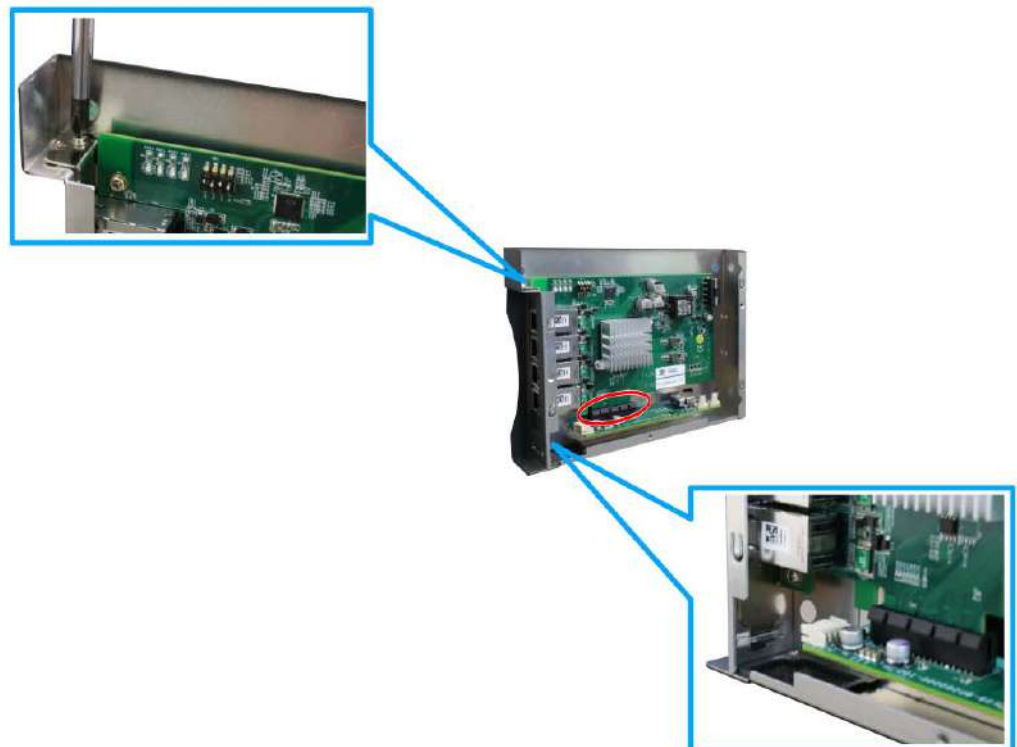

5. Once the PCIe add-on card has been installed, place the L-shaped cover back onto the Cassette module and secure the screw indicated.

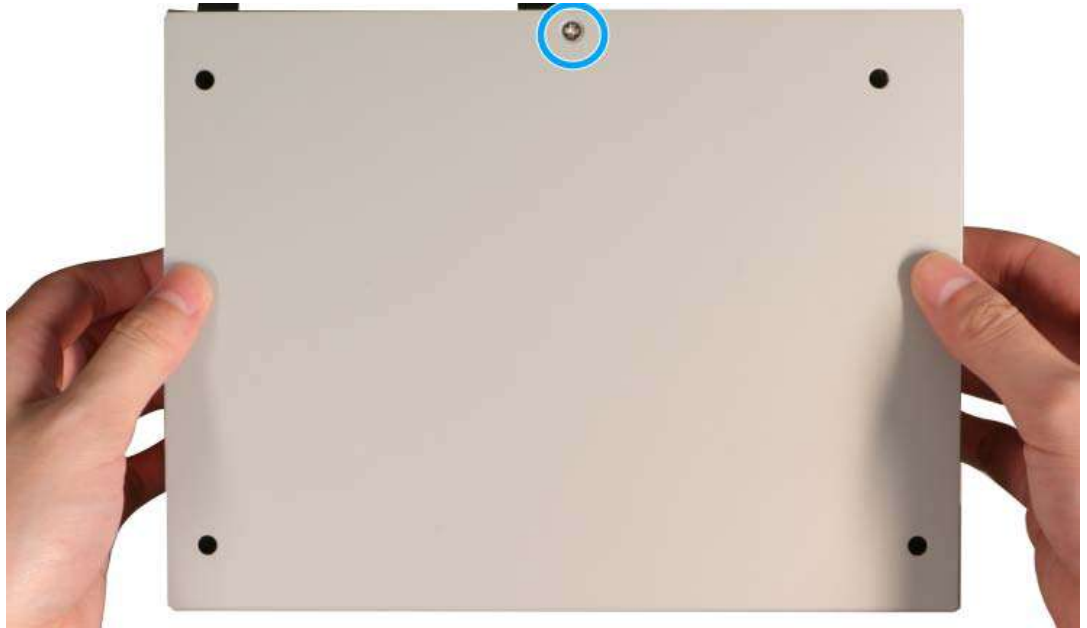

6. Gently lower the Cassette module back onto the system enclosure while ensuring the gold fingers are properly inserted.



7. Secure the screws indicated to complete the installation.





### 3.6 Wall Mount Bracket for Nuvo-2600 Series (Optional)

Neosys provides versatile mounting methods for Nuvo-2600 systems. You can use wall-mounting brackets to mount the system on the wall. To install the wall-mount your Nuvo-2600 controller, please refer to the instructions listed below.

#### 3.6.1 Wall-mounting Nuvo-2600 (Optional Accessory)

1. Place the system on a flat sturdy surface and turn the system upside-down. Remove the four screws and rubber standoffs indicated.



2. Take the two wall mount brackets and four M4 screws out of the accessory box, secure the wall mount brackets onto the bottom of the enclosure according to the illustration shown below.

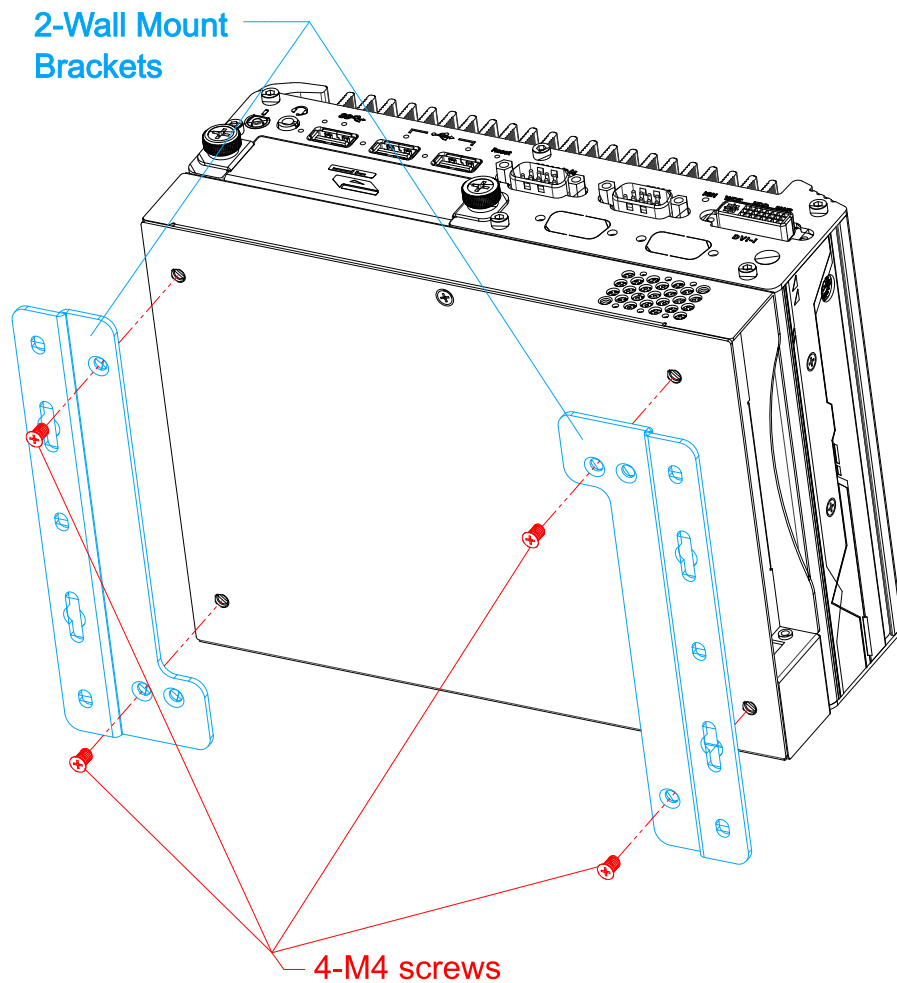

3. Place the system on a flat surface portion of the wall and secure it with four (4) M4 pan screws.
4. When wall mounting, place the heatsink fins perpendicular to the ground for better heat dissipation efficiency.

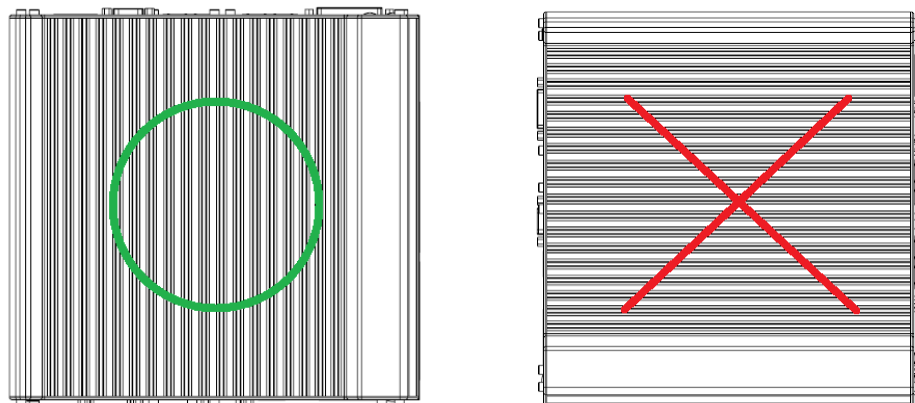

## 3.7 Powering On the System

There are three methods to power on the system

- Pressing the power button
- Sending a LAN packet via Ethernet (Wake-on-LAN)
- Powering on via ignition control (for Nuvo-2610DS-IGN only, please refer to [Ignition Control](#) section)

### 3.7.1 Powering On Using the Power Button

This is the simplest way to turn on your system. The power button is a non-latched switch and behaves as the ATX-mode on/off control. With DC power connected, pushing the power button will turn on the system and the PWR LED indicator will light up. Pushing the button when system is on will turn off the system. If your operating system supports ATX power mode (i.e. Microsoft Windows or Linux), pushing the power button while the system is in operation will result in a pre-defined system behavior, such as shutdown or hibernation.

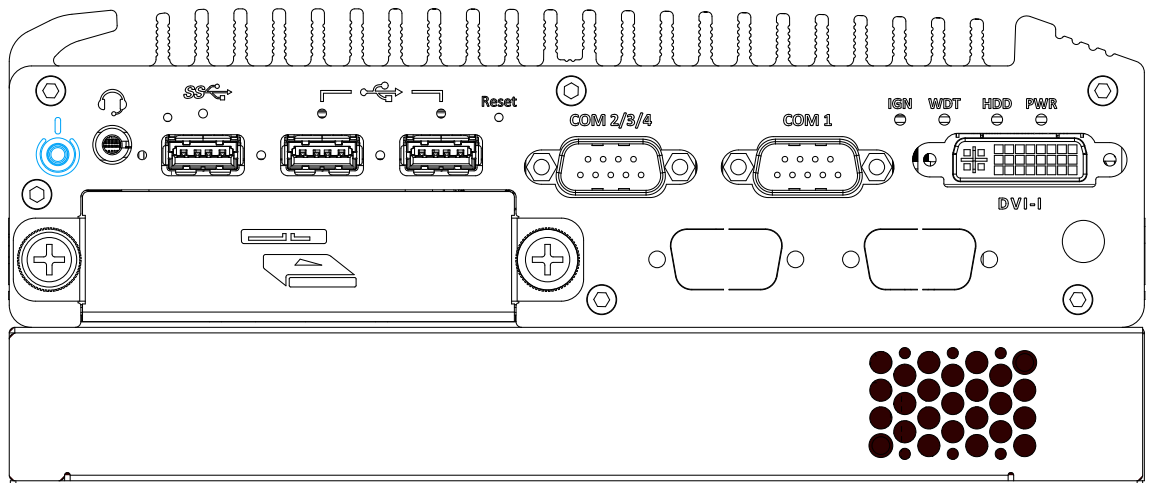

### 3.7.2 Powering On Using Wake-on-LAN

Wake-on-LAN (WOL) is a mechanism to wake up a computer system from a S5 (system off with standby power) state via issuing a magic packet. The system's Wake-on-LAN compatible GbE port is shown below.

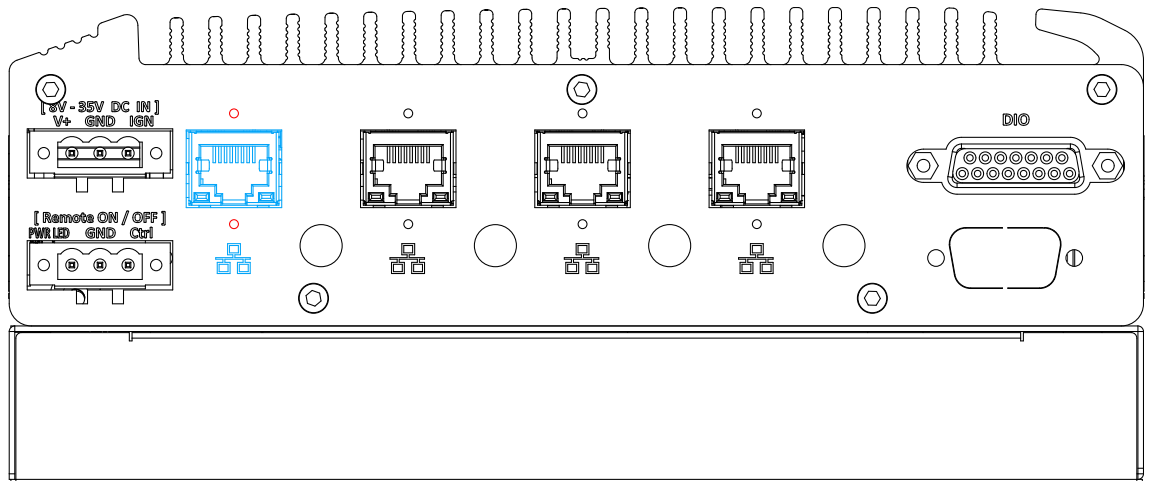

 **NOTE**

*Please make sure the Intel chipset and Ethernet driver has been properly installed prior to setting up WOL function.*

To enable WOL function, please set up WOL settings in the BIOS and in the operating system by follow the steps described below.

1. When the system boots up, press F2 to enter BIOS setup utility.
2. Go to the **[Power]>[Wake On LAN]** and set it to **[Enabled]**.
3. Press F10 to **“Save changes and exit BIOS”** and allow the system boot into the operating system.
4. Once booted into the Windows system, press **“Windows key + E”**, right-click on **“Network>Properties>Change adapter settings”**. Locate and double-click on the adapter Intel® I210 Gigabit Network Connection, click on **Configure**.

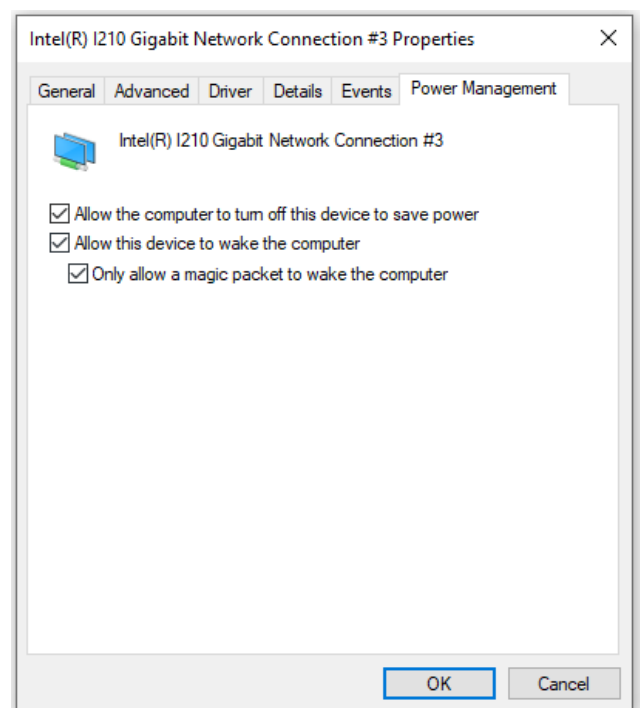

- Click on the **Power Management** tab and check the following options. Click on OK when done.

### Magic Packet

The magic packet is a broadcast frame containing anywhere within its payload 6 bytes of all 255 (FF FF FF FF FF FF in hexadecimal), followed by sixteen repetitions of the target computer's 48-bit MAC address.

For example, NIC's 48-bit MAC Address is 78h D0h 04h 0Ah 0Bh 0Ch

DESTINATION SOURCE MISC

FF FF FF FF FF FF

78 D0 04 0A 0B 0C 78 D0 04 0A 0B 0C

78 D0 04 0A 0B 0C 78 D0 04 0A 0B 0C

78 D0 04 0A 0B 0C 78 D0 04 0A 0B 0C

78 D0 04 0A 0B 0C 78 D0 04 0A 0B 0C

78 D0 04 0A 0B 0C 78 D0 04 0A 0B 0C

78 D0 04 0A 0B 0C 78 D0 04 0A 0B 0C

78 D0 04 0A 0B 0C 78 D0 04 0A 0B 0C

78 D0 04 0A 0B 0C 78 D0 04 0A 0B 0C

MISC CRC

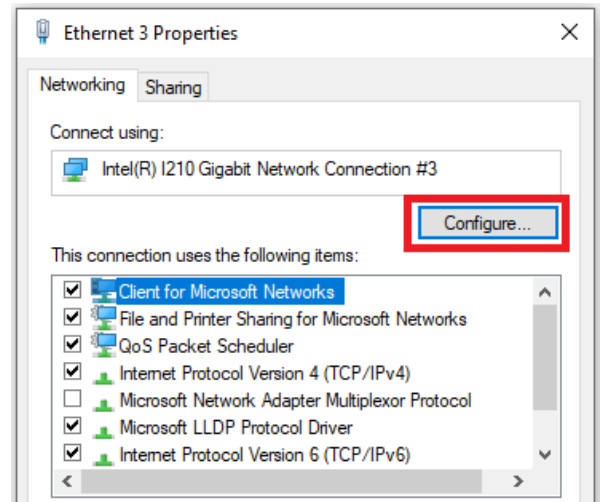

There are some free tools available on Internet that can be used to send a magic packet. Please refer to the following link to understand more about [Magic Packet](#).

### 3.8 Ignition Power Control (Optional)

The ignition power control module for in-vehicle applications is a MCU-based implementation that monitors the ignition signal and reacts to turn on/off the system according to predefined on/off delay. Its built-in algorithm supports other features such as ultra-low power standby, battery-low protection, system hard-off, etc. In this section, we'll illustrate the principle of ignition power control and operation modes.

#### 3.8.1 Principles of Ignition Power Control

The basic concept of ignition power control module is to control the timing correlation between ignition signal and system power status. A typical timing correlation is described in following diagram.

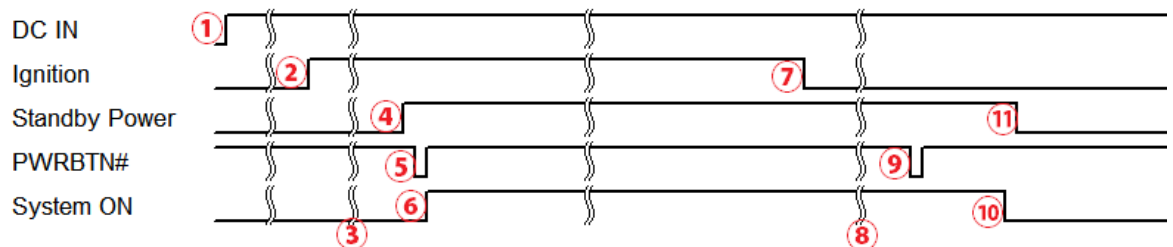

1. When DC power is supplied to the system, MCU starts to periodically detect ignition signal. Note that only MCU is working at this moment and the overall power consumption is less than 2 mW.
2. Ignition signal is active (both 12VDC and 24VDC ignition signals are accepted).
3. MCU starts to count a pre-defined power-on delay.
4. Once power-on delay expired, MCU turns on necessary standby power for the system (3.3VSB & 5VSB).
5. A PWRBTN# pulse is then issued to turn on the system (equivalent to one pressing the power button on the front panel).
6. The system is booting and becomes operational.
7. After a period of time, the ignition signal becomes inactive.
8. MCU starts to count a pre-defined power-off delay.
9. Once power-off delay expired, another PWRBTN# pulse is issued to perform a soft-off for the system (ex. a normal shutdown process for Windows system).
10. The system is completely shut down.
11. As MCU detects system is off, it turns off the standby power for the system, and operates in low power mode again (< 2mW power consumption).

### 3.8.2 Additional Features of Ignition Power Control

In addition to the typical timing correlation, the ignition power control module offers additional features to provide additional reliability for in-vehicle applications.

#### 1. Low battery detection

The ignition power control module continuously monitors the voltage of DC input when the system is operational. If input voltage is less than 9V (for 12VDC input) or less than 18V (for 24VDC input) over a 60-second duration, it will shut down the system automatically.

#### 2. Guarded power-on/ power-off delay duration

If ignition signal goes inactive during the power-on delay duration, the ignition power control module will cancel the power-on delay process and go back to idle status. Likewise if ignition signal goes active during the power-off delay duration, the ignition power control module will cancel the power-off delay process and keep the system running.

#### 3. System hard-off

In some cases, system may fail to shutdown via a soft-off operation due to system/application halts. The ignition power control module offers a mechanism called “hard-off” to handle this unexpected condition. By detecting the system status, it can determine whether the system is shutting down normally. If not, the ignition power control module will force cut-off the system power 10 minutes after the power-off delay duration.

#### 4. Smart off-delay

The ignition power control module offers two modes (mode 13& mode 14) which have very long power-off delay duration for applications require additional off-line time to process after the vehicle has stopped. In these two modes, the ignition power control module will automatically detect the system status during the power-off delay duration. If the system has shutdown (by the application software) prior to power-off delay expiring, it will cut off the system power immediately to prevent further battery consumption.

### 3.8.3 Wiring Ignition Signal (Optional)

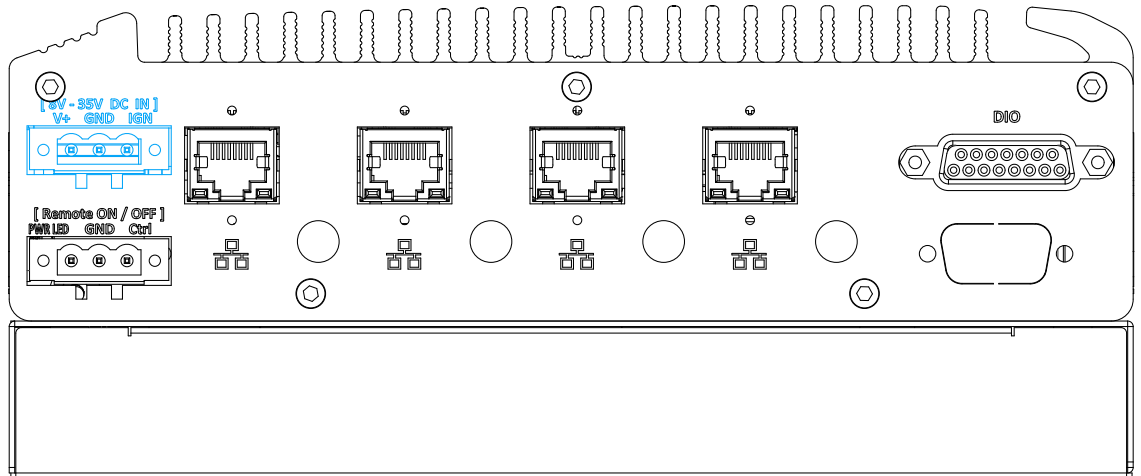

To have ignition power control for in-vehicle usage, you need to supply IGN signal to the system. The IGN input is located on the 3-pin pluggable terminal block (shared with DC power input). Below is the typical wiring configuration for in-vehicle applications.

1. Connect car Battery+ line (12V for sedan, 24V for bus/truck) to V+.
2. Connect car Batter-/ GND line to GND.
3. Connect ACC line to IGN.



**WARNING**

*Please make sure your DC power source and IGN signal share the same ground.*

*IGN input accepts 8-35VDC. Supply a voltage higher than 35VDC may damage the system.*



### 3.8.4 Configure your Windows system

When applying ignition power control to your system, please make sure you've configured your Windows system to initiate a shutdown process when pressing the power button. By default, Windows 10 goes to sleep (S3) mode when power button is pressed. As sleep (S3) is not a complete shutdown behavior, the ignition control function does not recognize the finish of a normal shut down process and thus users will encounter a system hard-off (power cut-off after 10 minutes). Please configure "When I press the power button" to "Shut down" in your Windows system settings.

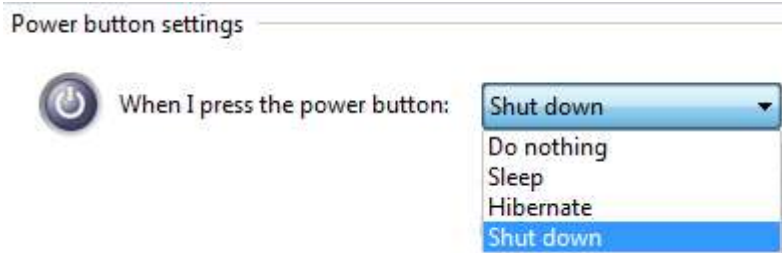

### 3.8.5 Operation Modes of Ignition Power Control (Optional)

You can use the rotary switch to configure the operation mode. The system offers 16 (0~15) operation modes with different power-on/power-off delay configurations.

The ignition control rotary switch can be located on the motherboard. Please refer to the “Disassembling the enclosure” section on how to remove the bottom panel and gaining access to the rotary switch.

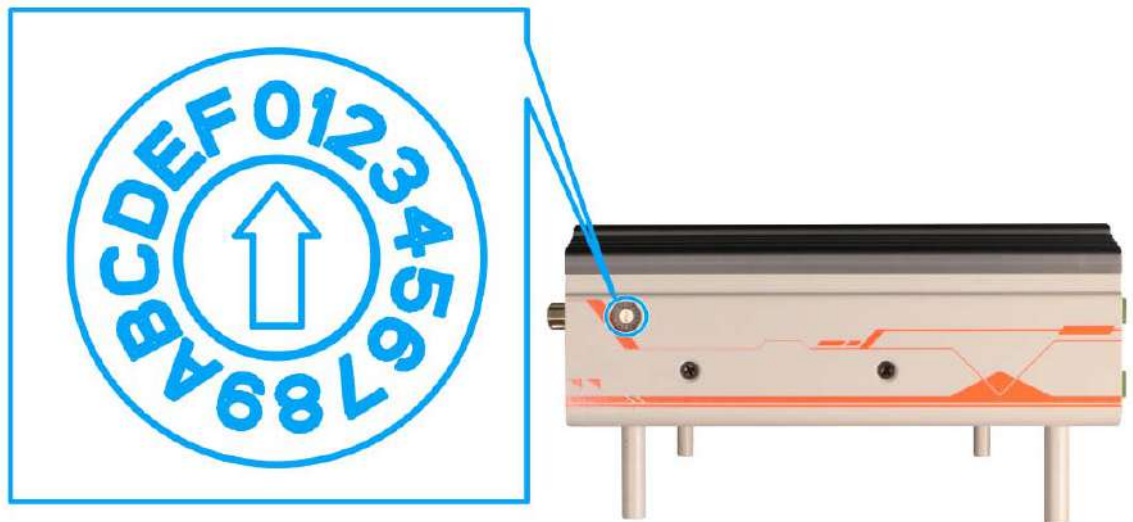

- **Mode 0**

Mode 0 is the ATX mode without power-on and power-off delay. User can only use the power button on the front panel to turn on or turn off the system.

Mode	Power-on Delay	Power-off Delay	Hard-off Timeout
0	N/A	N/A	N/A

- **Mode 1**

Mode 1 is AT mode without power-on and power-off delay. The system automatically turns on when DC power is applied. A retry mechanism is designed to repeat the power-on cycle if the system fails to boot up.

Mode	Power-on Delay	Power-off Delay	Hard-off Timeout
1	N/A	N/A	N/A

- **Mode 2**

Mode 2 is designed to have a very minor power on/ off delay of 160ms for applications that requires the system to start up almost at the same as the rest of the equipment it is working in collaboration with.

Mode	Power-on Delay	Power-off Delay	Hard-off Timeout
2	160ms	160ms	10 minutes

- **Mode 3 ~ Mode 12**

Mode 3 ~ Mode 12 have various power-on delay and power-off delay. Each mode supports a hard-off timeout of 10 minutes.

Mode	Power-on Delay	Power-off Delay	Hard-off Timeout
3	10 seconds	10 seconds	10 minutes
4	10 seconds	1 minute	10 minutes
5	10 seconds	5 minutes	10 minutes
6	30 seconds	1 minute	10 minutes
7	30 seconds	5 minutes	10 minutes
8	30 seconds	10 minutes	10 minutes
9	3 minutes	1 minute	10 minutes
10 (A)	3 minutes	10 minutes	10 minutes
11 (B)	3 minutes	30 minutes	10 minutes
12 (C)	10 minutes	30 minutes	10 minutes

- **Mode 13 (D) / Mode 14 (E)**

Mode 13 and Mode 14 are ignition power control modes with very long power-off delay. Both modes support the feature of “smart off-delay”, which automatically detect system status during power-off delay duration and cut off system power if system is off in prior to power-off delay expired.

Mode	Power-on Delay	Power-off Delay	Hard-off Timeout
13 (D)	30 seconds	2 hours	10 minutes
14 (E)	3 minutes	2 hours	10 minutes

# 4 System Configuration

## 4.1 BIOS Settings

The system is shipped with factory-default BIOS settings meticulously programmed for optimum performance and compatibility. In this section, we'll illustrate some of BIOS settings you may need to modify. Please always make sure you understand the effect of change before you proceed with any modification. If you are unsure of the function you are changing, it is recommended to change one setting at a time to see its effect(s).

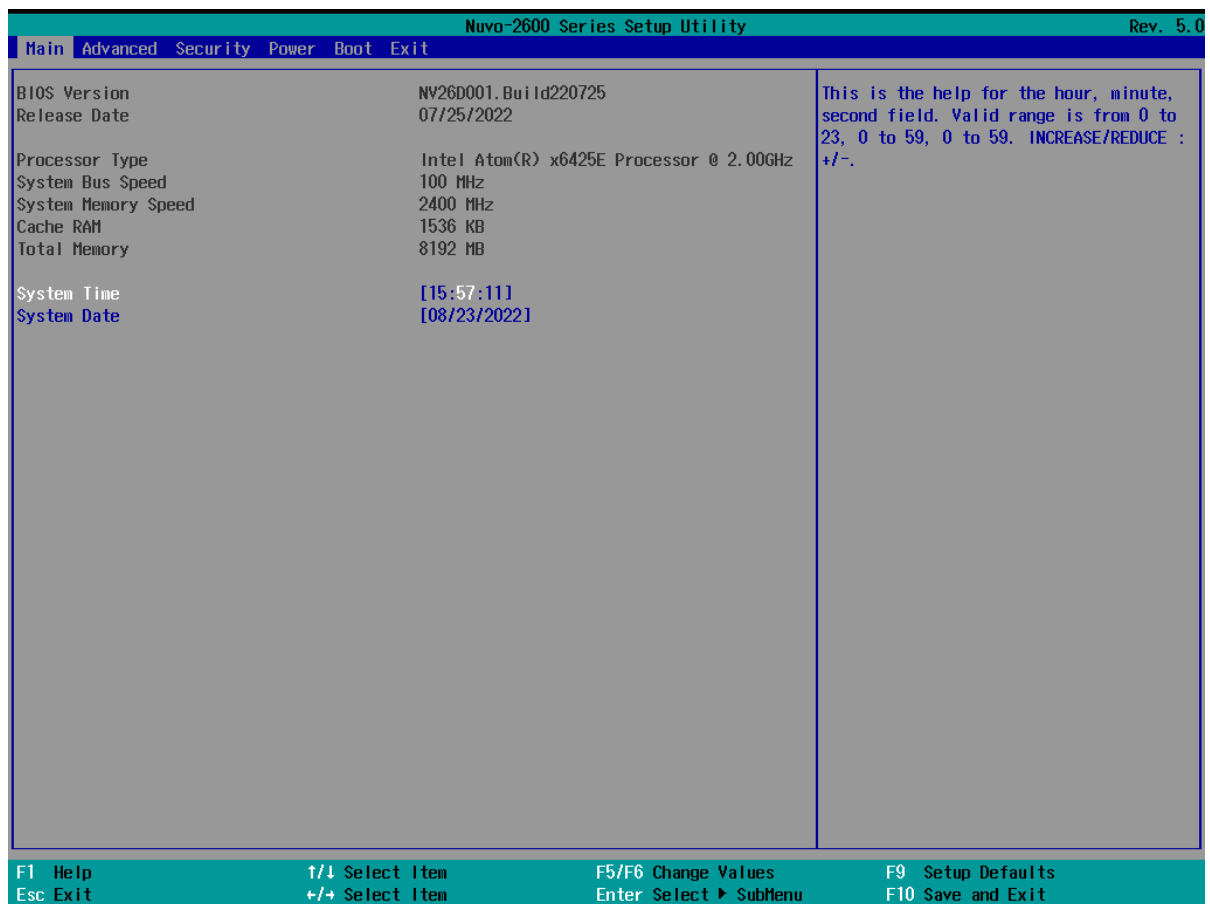

### NOTE

*Not all BIOS settings will be discussed in this section. If there is a particular BIOS setting you are after but is not discussed in this section, please contact Neousys Technical Support staff.*

### 4.1.1 COM 1PortConfiguration

The system's COM 1 port is a RS-485 port. You can enable/ disable both COM ports via BIOS settings.

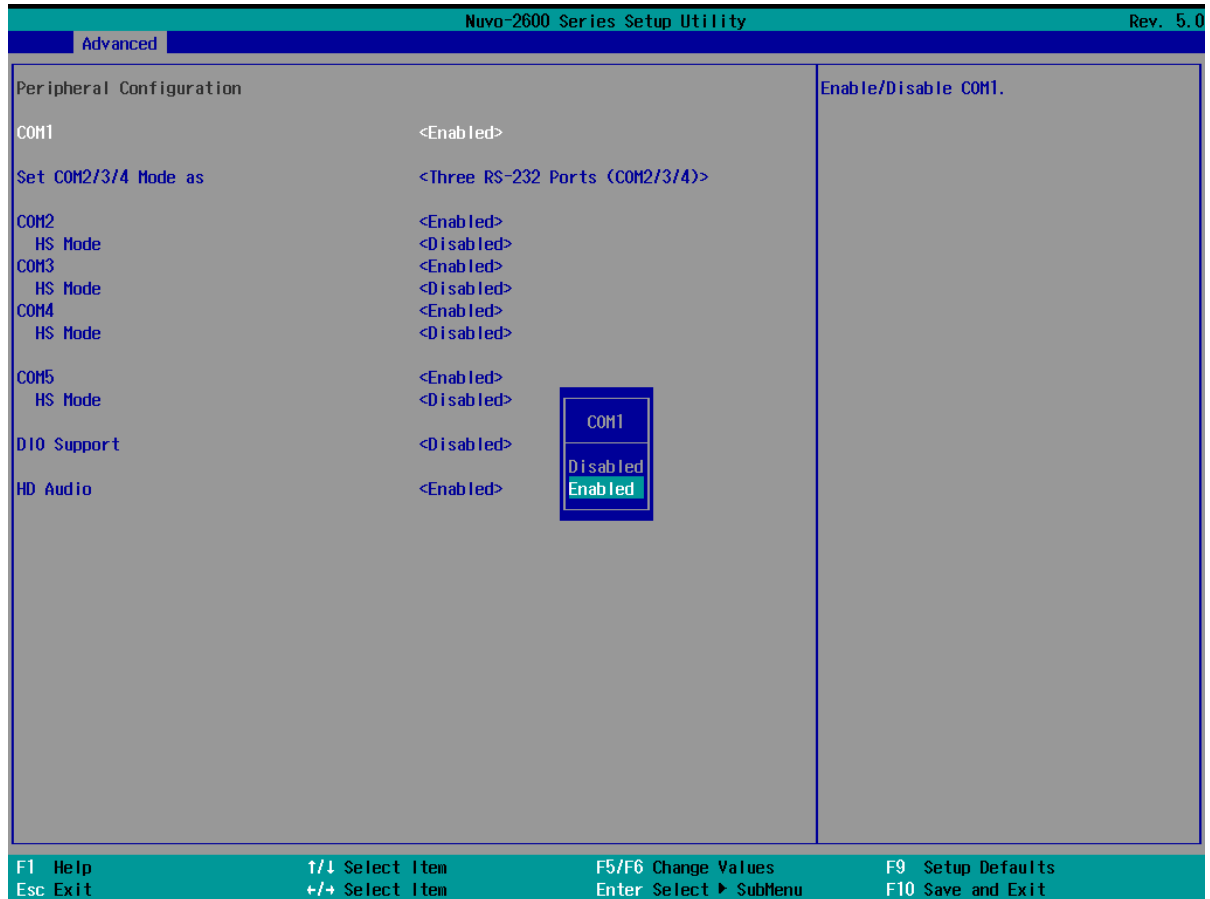

#### To set COM port operating mode:

1. Press **F2** when the system boots up to enter the BIOS setup utility.
2. Go to **[Advanced] → [Peripheral Configuration]**.
3. Highlight COM 1 port and select the **[Disabled or Enabled]** and press Enter to set the mode.
4. Once set, press **F10** to save setting and exit.

### 4.1.2 COM 2/ 3/ 4 Ports

The system's COM2 port can act as a 3x 3-wire RS-232 port (being COM ports 2/ 3/ 4), or it can act as a RS-422/ 485 (being a COM2 port). You can configure the COM ports via BIOS settings.

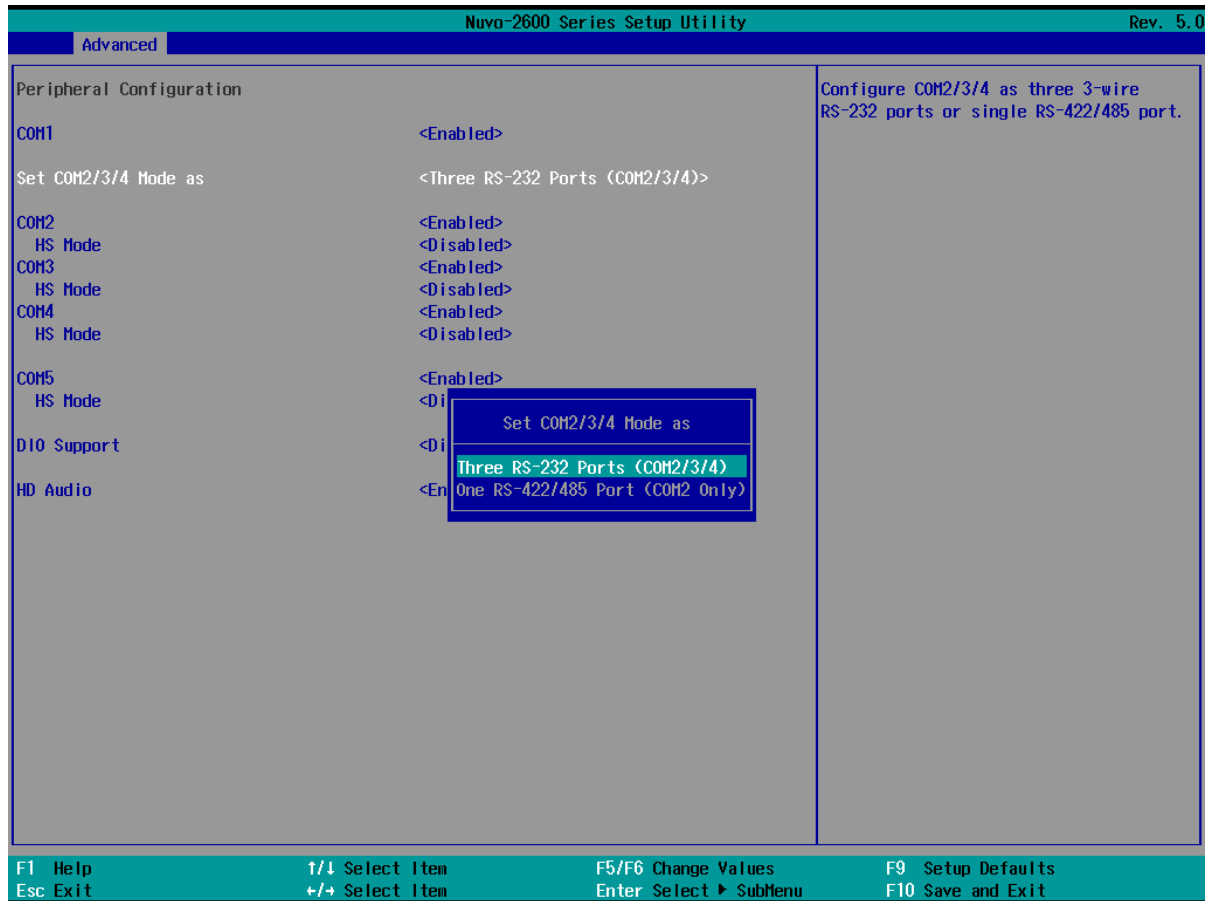

#### To set COM port operating mode:

1. Press **F2** when the system boots up to enter the BIOS setup utility.
2. Go to **[Advanced]** → **[Peripheral Configuration]**.
3. Highlight COM 1 port and select the **[Disabled or Enabled]** and press Enter to set the mode.
4. Once set, press **F10** to save setting and exit.

### 4.1.3 COM Port High Speed Mode

The high speed mode of each COM port effectively allows for the port's baud rate generator to operate at 8x the speed with an effective baud rate of 921,600 bps (115,200 x 8). Please refer to the following instructions on how to enable the high speed mode for your COM port (COM1 used as an example).



#### To set COM port high speed mode:

1. Press **F2** when the system boots up to enter the BIOS setup utility.
2. Go to **[Advanced] > [Peripheral Configuration]**.
3. Enable or set the **[Set COM Mode as]** option to the desired mode.
4. Highlight **[HS Mode]** and press ENTER to bring up options, highlight **[Enable]** and press ENTER.
5. Once set, press **F10** to save setting and exit.

#### 4.1.4 Power On After Power Failure Option

This option defines the behavior of system when DC power is supplied.

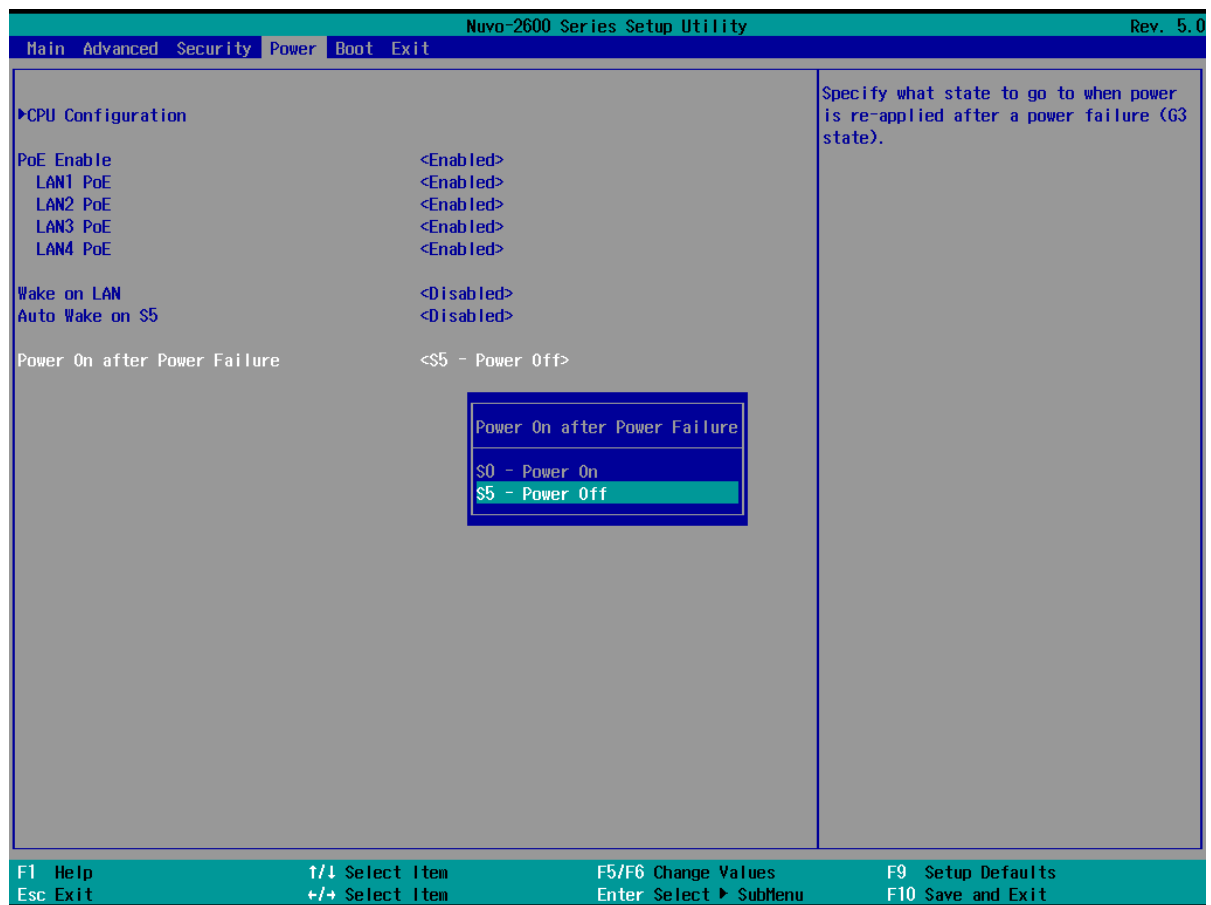

Value	Description
S0 – Power On	System is powered on when DC power is supplied.
S5 – Power Off	System is kept in off state when DC power is supplied.

To set “Power On after Power Failure” option:

1. When system boots up, press F2 to enter BIOS setup utility.
2. Go to **[Power] > [Power On after Power Failure]**.
3. Highlight **[Power On after Power Failure]**, press Enter to bring up setting options, S0 – Power On or S5 – Power Off, and press Enter to select the setting.
4. Press F10 to “Exit Saving Changes”.



### 4.1.5 Wake on LAN Option

Wake-on-LAN (WOL) is a mechanism which allows you to turn on your system via Ethernet connection. To utilize Wake-on-LAN function, you have to enable this option first in BIOS settings. Please refer to “Powering On Using Wake-on-LAN”to set up the system.

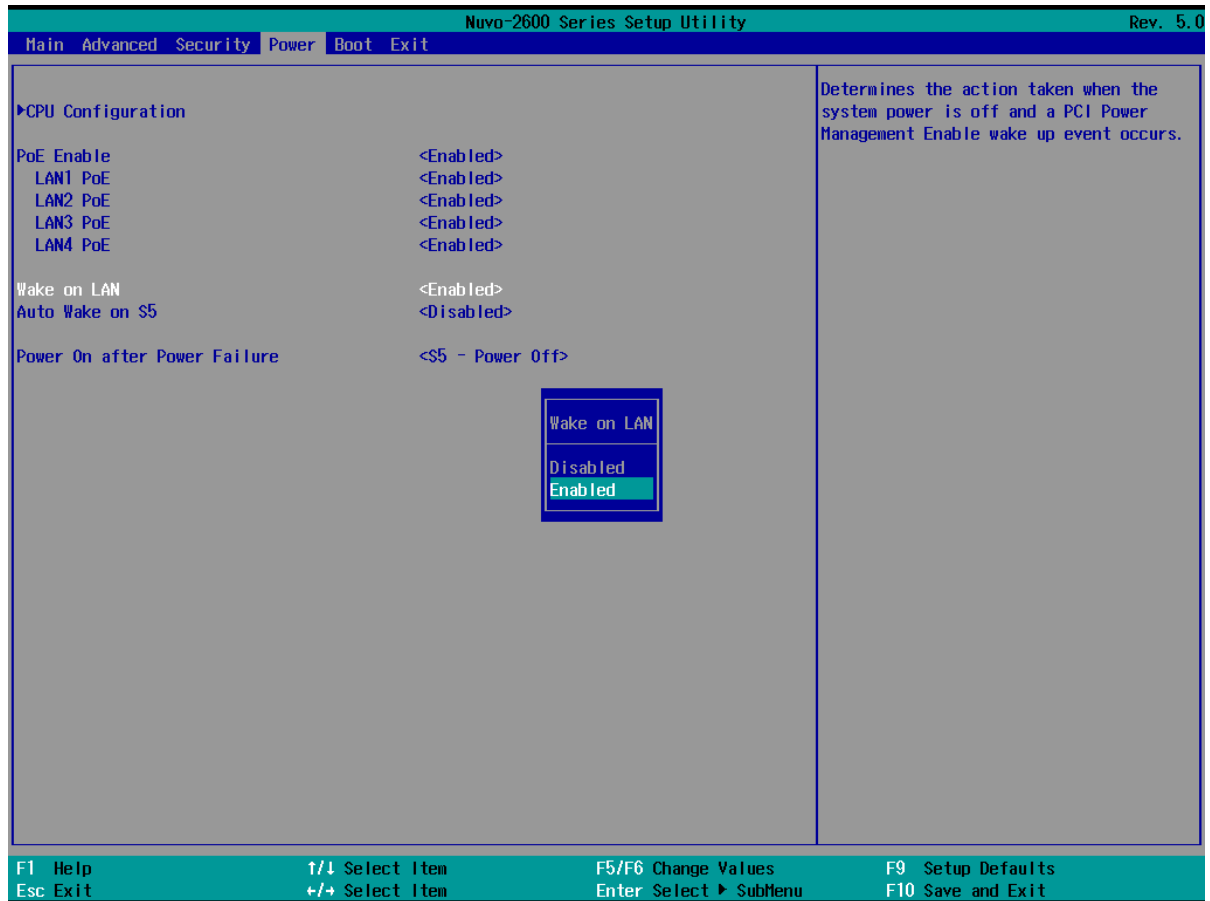

To enable/disable “Wake on LAN” option:

1. When system boots up, press F2 to enter BIOS setup utility.
2. Go to **[Power]> [Wake on LAN]**.
3. Press Enter to bring up setting options, scroll to the setting you desire and press Enter to set.
4. Press F10 to “Exit Saving Changes.

### 4.1.6 Add Boot Options

The Add Boot Options dedicates the boot sequence order of a newly added device (eg. USB flash drive). The setting allows you to set the newly added device to boot first or as the last device on the list.

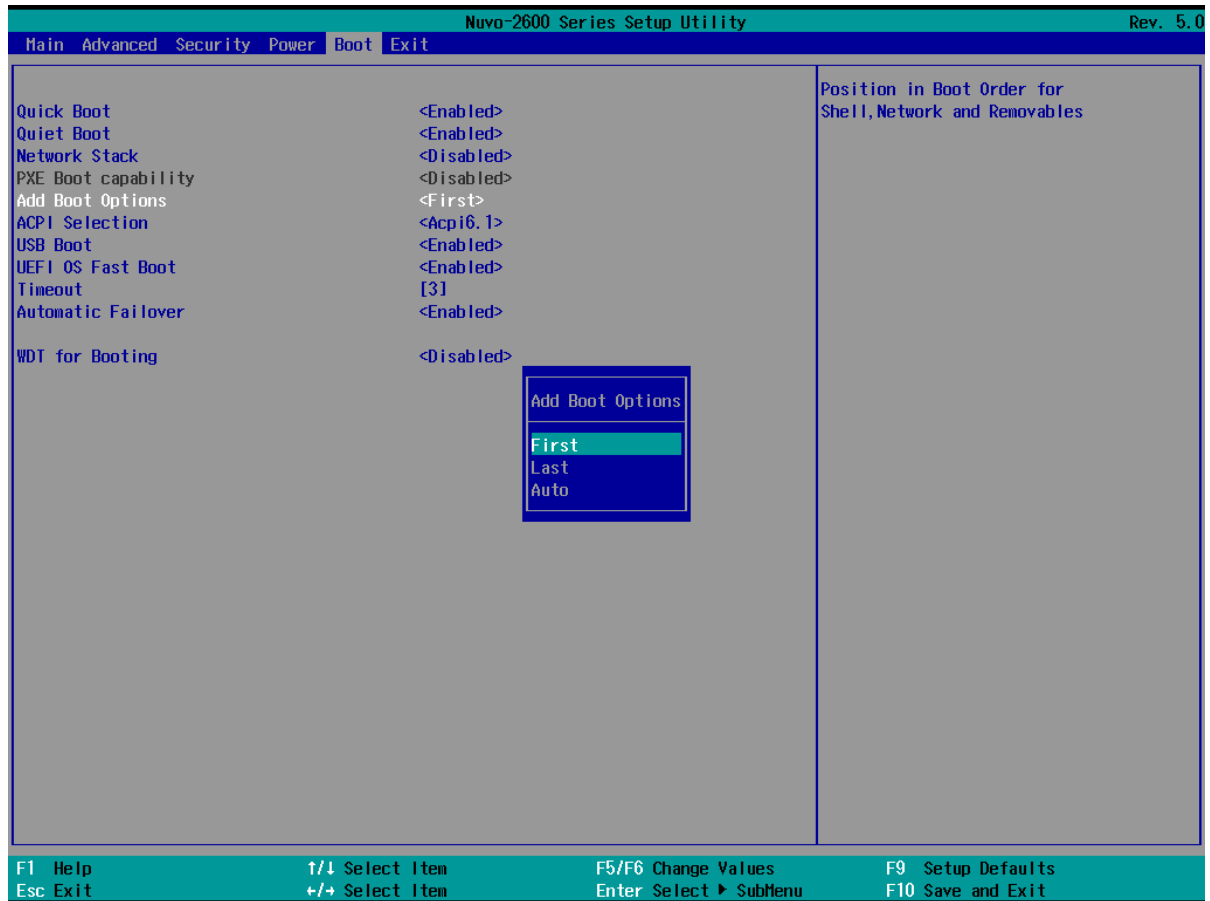

To set Add Boot Options:

1. When system boots up, press F2 to enter BIOS setup utility.
2. Go to [Boot] > [Add Boot Option], press Enter to bring up options, First or Last.
3. Highlight your selection and press Enter, press F10 to "Exit Saving Changes".

### 4.1.7 Watchdog Timer for Booting

The Watchdog timer setting in the BIOS ensures a successful system boot by specifying a timeout value. If the Watchdog timer is not stopped and expires, the BIOS will issues a reset command to initiate another boot process. There are two options in BIOS menu, “**Automatically after POST**” and “**Manually after Entering OS**”. When “**Automatically after POST**” is selected, the BIOS automatically stop the watchdog timer after POST (Power-On Self Test) OK. When “**Manually after Entering OS**” is selected, it’s user’s liability to stop the watchdog timer when entering OS. This guarantees the system can always boot into OS, otherwise another booting process will be initiated.

For information about programming watchdog timer, please refer to **Appendix A Watchdog Timer & Isolated DIO**.

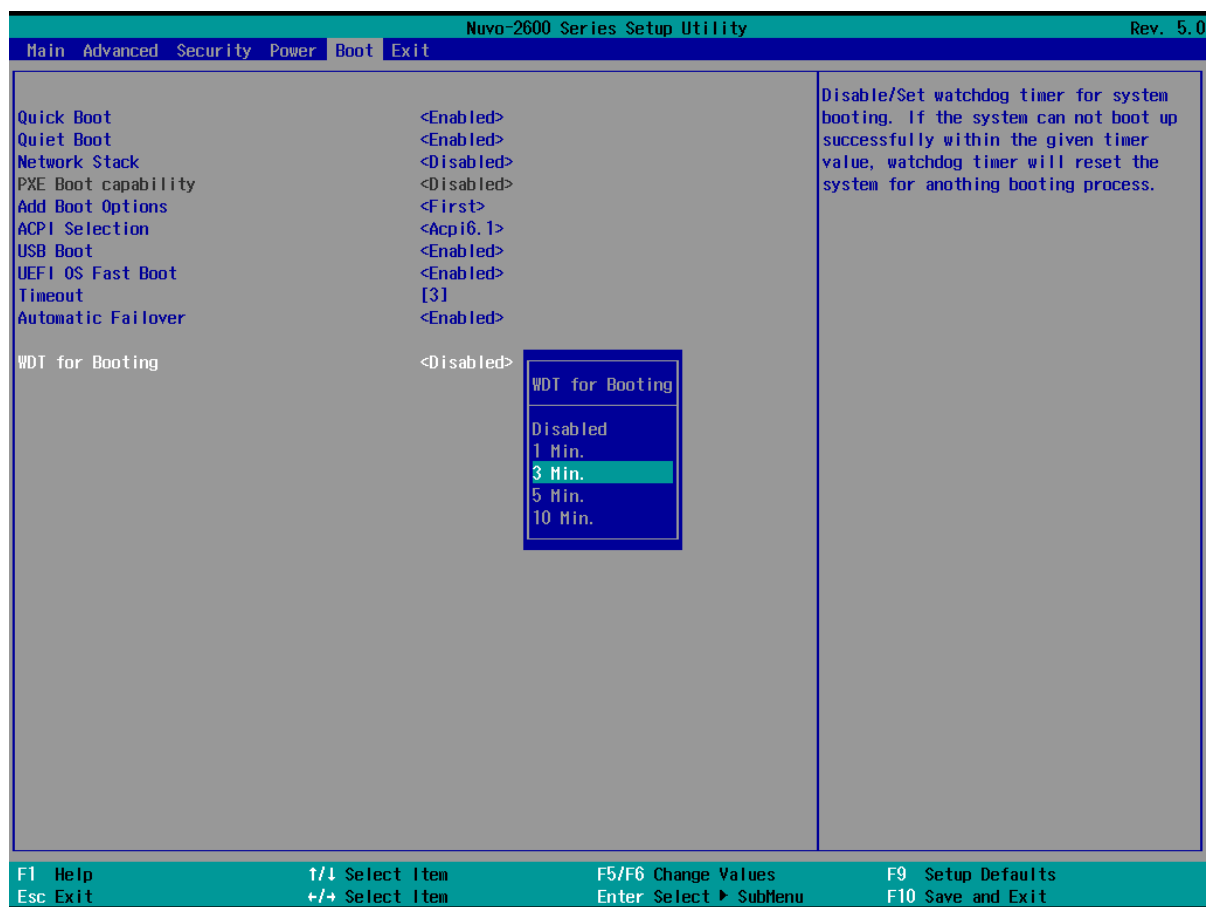

To set the watchdog timer for boot in BIOS:

1. When system boots up, press F2 to enter BIOS setup utility.
2. Go to **[Boot]** menu.
3. Disable or select timeout value for **[WDT for Booting]** option.
4. Once you give a timeout value, the **[WDT Stop Option]** option appears. You can select “*Automatically after POST*” or “*Manually after Entering OS*”.
5. Press F10 to “Exit Saving Changes.

## 5 OS Support and Driver Installation

### 5.1 Operating System Compatibility

Due to Intel's policy, the system only provides driver support for Windows 10 64-bit. For Linux support, please use Linux kernel versions no later than 5.8. The following list contains the operating systems which have been tested in Neosys Technology Inc.

1. Microsoft Windows10Professional 64-bit
2. Microsoft Windows 10 IoT Enterprise 64-bit
3. Ubuntu 20.04.2 LTS\*\* (5.8 kernel)



#### NOTE

*\*For Linux system, user may need to manually compile and install the driver for Intel® I210 GbE controller if the driver is not embedded in kernel.*

Neosys may remove or update operating system compatibility without prior notice. Please contact us if your operating system of choice is not on the list.

### 5.2 Driver Installation

To manually install the drivers, please click on this [link](#) to download the drivers.

### 5.3 Driver Installation for Watchdog Timer Control

Neosys provides a driver package which contain function APIs for Watchdog Timer control function. You should install the driver package (WDT\_DIO\_Setup.exe) in prior to use these functions. Please note that you must install WDT\_DIO\_Setup\_v2.3.1.8 or later versions.

Please refer to this [link](#) to download WDT\_DIO.

# Appendix A Using WDT & DIO

## Watchdog Timer

The watchdog timer (WDT) function ensures reliable system operation. The WDT is a hardware mechanism to reset the system if the watchdog timer expires. Users can start the WDT and keep resetting the timer to make sure the system or program is running. Otherwise, the system shall be reset.

In this section, we'll illustrate how to use the function library provided by Neosys to program the WDT functions. Currently, WDT driver library supports Windows 10 32-bit and 64-bit versions. For other OS support, please contact Neosys Technology for further information.

## Installing WDT\_DIO Library

The WDT\_DIO function library is delivered in the form of a setup package named **WDT\_DIO\_Setup.exe**. Prior to programming WDT, you should execute the setup program and install the WDT library. Please use the following WDT\_DIO\_Setup packages according to your operating systems and application.

- For Windows 10 64-bit OS with 64-bit application (x64 mode), please install WDT\_DIO\_Setup\_v2.3.1.8(x64).exe or later version.
- For Windows 10 64-bit OS with 32-bit application (WOW64 mode), please install WDT\_DIO\_Setup\_v2.3.1.8(wow64).exe or later version.

## WDT and DIO Library Installation

To setup WDT & DIO Library, please follow instructions below.

1. Execute **WDT\_DIO\_Setup.2.3.1.8.exe** (or later) and the following dialog appears.

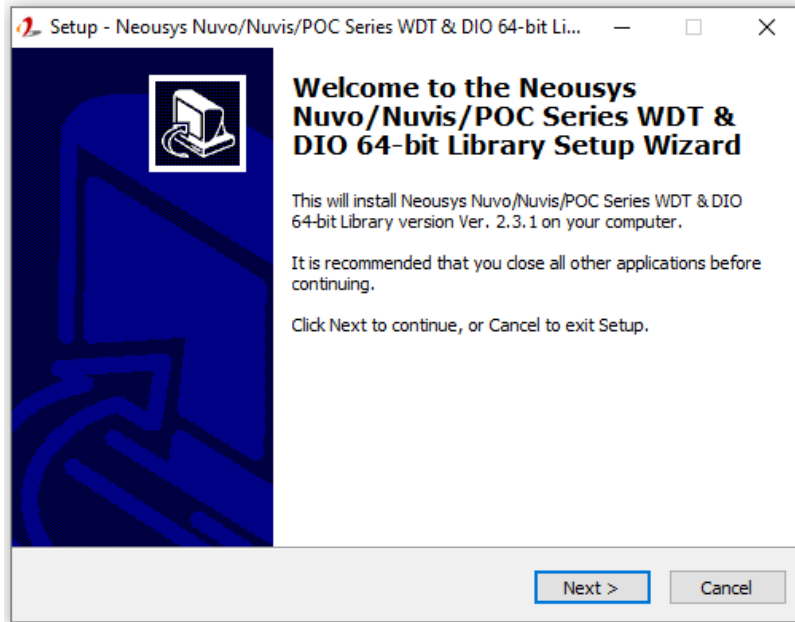

2. Click "Next >" and specify the directory of installing related files. The default directory is *C:\Neosys\WDT\_DIO*.

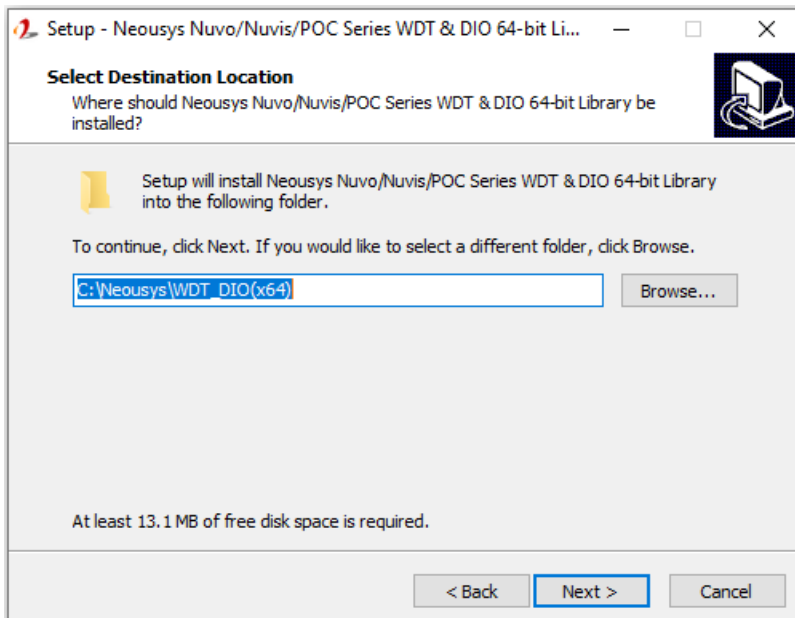

3. Once the installation has finished, a dialog will appear to prompt you to reboot the system. The WDT & DIO library will take effect after the system has rebooted.

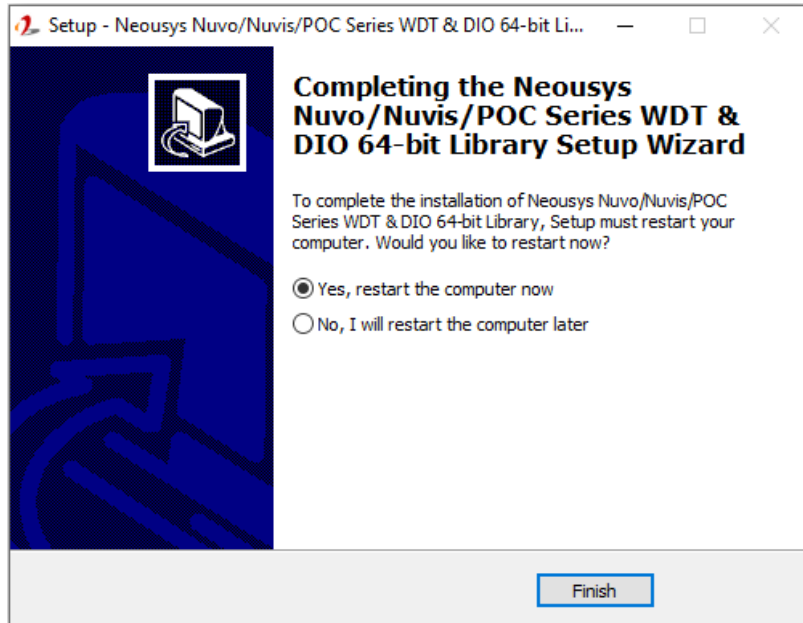

4. When programming your WDT or DIO program, the related files are located in

<b>Header File:</b>	\Include
<b>Library File:</b>	\Lib
<b>Function</b>	\Manual
<b>Reference:</b>	
<b>Sample Code:</b>	\Sample\WDT_Demo(Demo for Watchdog Timer)  \Sample\DIO_Demo (Demo for Polling I/O )

## WDT Functions

### InitWDT

<b>Syntax</b>	BOOL InitWDT(void);
<b>Description:</b>	Initialize the WDT function. You should always invoke InitWDT() before set or start watchdog timer.
<b>Parameter</b>	None
<b>Return Value</b>	<b>TRUE:</b> Successfully initialized <b>FALSE:</b> Failed to initialize
<b>Usage</b>	BOOL bRet = InitWDT()

### SetWDT

<b>Syntax</b>	BOOL SetWDT(WORD tick, BYTE unit);
<b>Description</b>	Set timeout value and unit for watchdog timer. When InitWDT() is invoked, a default timeout value of 255 seconds is assigned.
<b>Parameter</b>	<b>tick</b> WORD value (1 ~ 65535) to indicate timeout ticks. <b>unit</b> BYTE value (0 or 1) to indicate unit of timeout ticks. 0 : unit is minute 1 : unit is second
<b>Return Value</b>	If value of unit is correct (0 or 1), this function returns TRUE, otherwise FALSE.
<b>Usage</b>	WORD tick=255; BYTE unit=1; //unit is second. BOOL bRet = SetWDT(tick, unit); //timeout value is 255 seconds



## StartWDT

<b>Syntax</b>	BOOL StartWDT(void);
<b>Description</b>	Starts WDT countdown. Once started, the WDT LED indicator will begin blinking. If ResetWDT() or StopWDT is not invoked before WDT countdowns to 0, the WDT expires and the system resets.
<b>Parameter</b>	None
<b>Return Value</b>	If the timeout value is given in correct format (WDT started), this function returns TRUE, otherwise FALSE
<b>Usage</b>	BOOL bRet = StartWDT()

## ResetWDT

<b>Syntax</b>	BOOL ResetWDT(void);
<b>Description</b>	Reset the timeout value to the value given by SetWDT().If ResetWDT() or StopWDT is not invoked before WDT countdowns to 0, the WDT expires and the system resets.
<b>Parameter</b>	None
<b>Return Value</b>	Always returns TRUE
<b>Usage</b>	BOOL bRet = ResetWDT()

## StopWDT

<b>Syntax</b>	BOOL StopWDT(void);
<b>Description</b>	Stops the countdown of WDT. When WDT has stopped, the WDT LED indicator stops blinking.
<b>Parameter</b>	None
<b>Return Value</b>	Always returns TRUE
<b>Usage</b>	BOOL bRet = StopWDT()

## DIO Functions

### InitDIO

<b>Syntax</b>	BOOL InitDIO(void);
<b>Description</b>	Initialize the DIO function. You should always invoke InitDIO() before write/read anyDIO port/channel.
<b>Parameter</b>	None
<b>Return Value</b>	Returns TRUE if initialization successes, FALSE if initialization failed.
<b>Usage</b>	BOOL bRet = InitWDT();

### DIReadLine

<b>Syntax</b>	BOOL DIReadLine(BYTE ch);
<b>Description</b>	Read a single channel of isolated digital input.
<b>Parameter</b>	<b>ch</b> BYTE value specifies the DI channel to be read. <i>Ch</i> should be a value of 0 ~ 7.
<b>Return Value</b>	The status (TRUE or FALSE) of the specified DI channel.
<b>Usage</b>	BYTE ch=3; //DI channel #3  BOOL DIChValue = DIReadLine(ch); //read DI channel #3

### DIReadPort

<b>Syntax</b>	WORD DIReadPort(void);
<b>Description</b>	Read the entire isolated digital input port (8 channels).
<b>Parameter</b>	None
<b>Return Value</b>	A WORD value (0~255) indicates the status of DI port (8 DI channels).
<b>Usage</b>	WORD DIPortValue = DIReadPort ();

### DOWriteLine

<b>Syntax</b>	void DOWriteLine(BYTE ch, BOOL value);
<b>Description</b>	Write a single channel of isolated digital output.
<b>Parameter</b>	<p><b>ch</b>            BYTE value specifies the DO channel to be written. <i>Ch</i> should be a value of 0 ~ 7.</p> <p><b>value</b>            BOOL value (TRUE or FALSE) specifies the status of DO channel.</p>
<b>Return Value</b>	None
<b>Usage</b>	<pre>           BYTE ch=3; //DI channel #3           BOOL DOChValue=TRUE;            DOWriteLine(ch, DOChValue); //write DO channel #3 as           TRUE         </pre>

### DOWritePort

<b>Syntax</b>	void DOWritePort(WORD value);
<b>Description</b>	Write the entire isolated digital output port (8 channels).
<b>Parameter</b>	<p><b>value</b>            WORD value specifies the status of the DO port. <i>Value</i> should be a value of 0~255.</p>
<b>Return Value</b>	None
<b>Usage</b>	<pre>           WORD DOPortValue=0XFF; //11111111b           DOWritePort(DOPortValue); //write DO port as 11111111b         </pre>

# Appendix B PoE On/ Off Control

The system offers 802.3at PoE+ ports and users are allowed to manually turn on or off the power supply of each PoE port. This can be useful in power device (PD) fault-recovery or power reset. The APIs are part of Neosys WDT\_DIO driver package. Please follow the instructions in [Appendix A Watchdog Timer & Isolated DIO](#) for installation before programming PoE on/off control function.



**NOTE**

Nuvo-2600 series will be shown in illustrations for demonstration purposes.

## GetStatusPoEPort

<b>Syntax</b>	BYTE GetStatusPoEPort (Byte port);
<b>Description</b>	Get current on/off status of designated PoE port.
<b>Parameter</b>	<i>port</i>  BYTE value specifies the index of PoE port. Please refer to the following illustration, <i>port</i> should be a value of 1 ~ 4
<b>Return Value</b>	BYTE value indicating PoE on/off status 0 if port is disabled (off) 1 if port is enabled (on)
<b>Usage</b>	BYTE bEnabled = GetStatusPoEPort (1); //Get on/off status of PoE Port#1

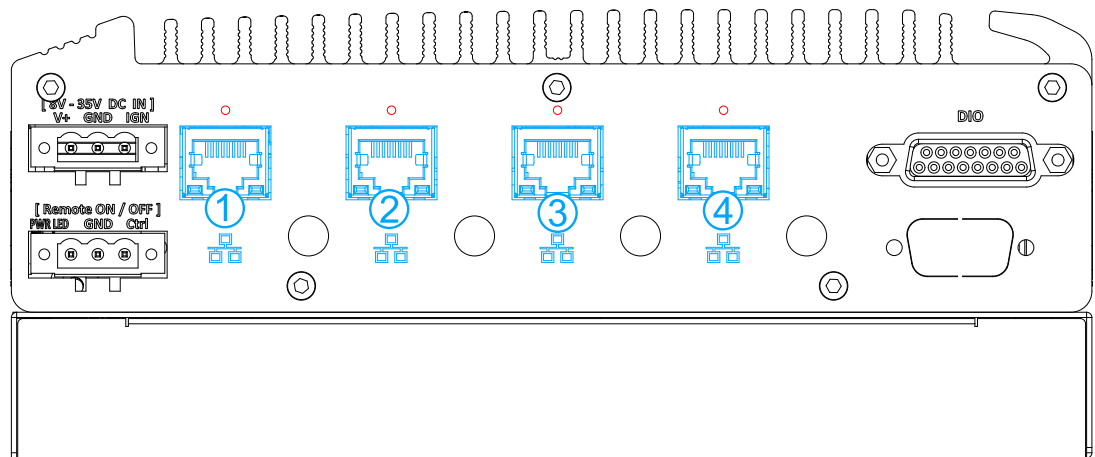

## EnablePoEPort

<b>Syntax</b>	BOOL EnablePoEPort (BYTE port);
<b>Description</b>	Turn on PoE power of designated PoE port.
<b>Parameter</b>	<i>port</i>  BYTE value specifies the index of PoE port. Please refer to the following illustration, <i>port</i> should be a value of 1 ~ 4
<b>Return Value</b>	<b>TRUE</b> if enabled success <b>FALSE</b> if fail to enable.
<b>Usage</b>	BOOL bRet = EnablePoEPort (1); //Turn on PoE Port#1

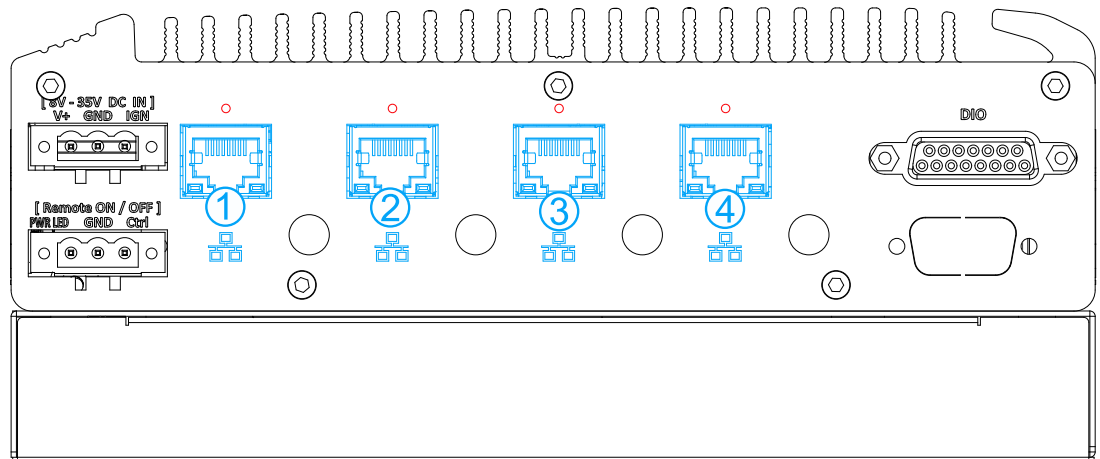

## DisablePoEPort

<b>Syntax</b>	BOOL DisablePoEPort (BYTE port);
<b>Description</b>	Turn off PoE power of designated PoE port
<b>Parameter</b>	<i>port</i>  BYTE value specifies the index of PoE port. Please refer to the following illustration, <i>port</i> should be a value of 1 ~ 4
<b>Return Value</b>	<b>TRUE</b> if disabled success <b>FALSE</b> if fail to disable
<b>Usage</b>	BOOL bRet = DisablePoEPort (1); //Turn off PoE Port#1

