



MODEL:  
**TANK-610-BW**

Fanless Embedded System with Intel® Celeron® N3160 processor,  
VGA, HDMI, Two Gigabit Ethernet, Four USB 3.0,  
RS-232/422/485, RoHS Compliant

## User Manual

# Revision

---

Date	Version	Changes
27 November 2017	1.02	Add Chapter 4: System Motherboard
10 April 2017	1.01	Add Appendix E: Watchdog Timer
6 June 2016	1.00	Initial release

# Copyright

---

## COPYRIGHT NOTICE

The information in this document is subject to change without prior notice in order to improve reliability, design and function and does not represent a commitment on the part of the manufacturer.

In no event will the manufacturer be liable for direct, indirect, special, incidental, or consequential damages arising out of the use or inability to use the product or documentation, even if advised of the possibility of such damages.

This document contains proprietary information protected by copyright. All rights are reserved. No part of this manual may be reproduced by any mechanical, electronic, or other means in any form without prior written permission of the manufacturer.

## TRADEMARKS

All registered trademarks and product names mentioned herein are used for identification purposes only and may be trademarks and/or registered trademarks of their respective owners.

# Manual Conventions

---



## WARNING

Warnings appear where overlooked details may cause damage to the equipment or result in personal injury. Warnings should be taken seriously.



## CAUTION

Cautionary messages should be heeded to help reduce the chance of losing data or damaging the product.



## NOTE

These messages inform the reader of essential but non-critical information. These messages should be read carefully as any directions or instructions contained therein can help avoid making mistakes.



## HOT SURFACE

This symbol indicates a hot surface that should not be touched without taking care.

# Table of Contents

<b>1 INTRODUCTION</b> .....	<b>1</b>
1.1 OVERVIEW.....	2
1.2 FEATURES.....	2
1.3 TECHNICAL SPECIFICATIONS.....	3
1.4 FRONT PANEL.....	5
1.5 REAR PANEL.....	6
1.6 DIMENSIONS.....	7
<b>2 UNPACKING</b> .....	<b>8</b>
2.1 UNPACKING.....	9
2.2 PACKING LIST.....	9
2.3 OPTIONAL ITEMS.....	11
<b>3 INSTALLATION</b> .....	<b>12</b>
3.1 ANTI-STATIC PRECAUTIONS.....	13
3.2 INSTALLATION PRECAUTIONS.....	13
3.3 HARD DISK DRIVE (HDD) INSTALLATION.....	14
3.4 WIRELESS LAN MODULE INSTALLATION (OPTIONAL).....	16
3.5 MOUNTING THE SYSTEM.....	19
3.5.1 Mounting with Mounting Brackets.....	19
3.5.2 Mounting with VESA Mount Kit (Optional).....	20
3.6 AT/ATX MODE SELECTION.....	21
3.6.1 AT Power Mode.....	22
3.6.2 ATX Power Mode.....	22
3.7 RESET THE SYSTEM.....	23
3.8 POWERING ON/OFF THE SYSTEM.....	23
3.9 EXTERNAL PERIPHERAL DEVICE CONNECTION.....	24
3.9.1 Audio Connection.....	24
3.9.2 HDMI Device Connection.....	25
3.9.3 LAN Connection.....	26
3.9.4 Serial Device Connection.....	27

3.9.5 USB Device Connection.....	28
3.9.6 VGA Monitor Connection .....	29
<b>4 SYSTEM MOTHERBOARD.....</b>	<b>31</b>
4.1 OVERVIEW.....	32
4.1.1 Layout .....	32
4.2 INTERNAL PERIPHERAL CONNECTORS.....	33
4.2.1 Battery Connector (BAT1).....	33
4.2.2 BIOS Programming Connector (SPI1).....	33
4.2.3 Digital I/O Connector (DIO1).....	34
4.2.4 Debug Connector (DEBUGCN1) .....	34
4.2.5 FPC Connector (CNI).....	34
4.2.6 EC Programming Connector (JSPI1).....	35
4.2.7 Keyboard/Mouse Connector (KB_MS_CN1).....	35
4.2.8 SATA 6Gb/s Drive Connectors (SATA1).....	35
4.2.9 SATA Power Connector (SATA_PWR2).....	35
4.2.10 USB 2.0 Connectors (USB1).....	35
4.2.11 USB 2.0 Connectors (USB2).....	36
4.3 EXTERNAL INTERFACE PANEL CONNECTORS.....	36
4.3.1 Audio Jack (JAUDIO1).....	37
4.3.2 Ethernet and USB2.0 Connectors (USB_LAN1).....	37
4.3.3 Ethernet and USB2.0 Connectors (USB_LAN2).....	38
4.3.4 HDMI Connector (HDMI1).....	38
4.3.5 Power Connector (DC_IN1).....	39
4.3.6 Power Connector (DC_IN2).....	39
4.3.7 RS-232 Serial Port Connector (COM1-2) .....	39
4.3.8 RS-232 Serial Port Connector (COM3-4) .....	40
4.3.9 RS-232 Serial Port Connector (COM7-8) .....	40
4.3.10 RS-232 Serial Port Connector (COM5-6) .....	40
4.3.11 VGA Connector (VGA1).....	41
4.4 JUMPER SETTINGS.....	42
4.4.1 AT/ATX Mode Select Switch (AT_SEL1).....	42
4.4.2 Clear CMOS Button (J_CMOS1).....	42
4.4.3 M-SATA Auto-detect Jumper (MIMI_SW1).....	42
4.4.4 System Reset Button (RST1).....	43

<b>5 BIOS</b> .....	<b>44</b>
5.1 INTRODUCTION .....	45
5.1.1 Starting Setup.....	45
5.1.2 Using Setup .....	45
5.1.3 Getting Help.....	46
5.1.4 Unable to Reboot after Configuration Changes .....	46
5.1.5 BIOS Menu Bar.....	46
5.2 MAIN .....	47
5.3 ADVANCED.....	48
5.3.1 ACPI Settings.....	49
5.3.2 F81866 Super IO Configuration .....	50
5.3.2.1 Serial Port n Configuration .....	50
5.3.3 H/W Monitor .....	57
5.3.4 IT8528SEC Super IO Configuration.....	58
5.3.4.1 Serial Port n Configuration .....	59
5.3.5 RTC Wake Settings .....	61
5.3.6 Serial Port Console Redirection .....	63
5.3.6.1 Console Redirection Settings .....	64
5.3.7 iEi Feature.....	66
5.3.8 CPU Configuration.....	67
5.3.9 SATA Configuration .....	69
5.3.10 USB Configuration.....	70
5.4 CHIPSET.....	71
5.4.1 North Bridge Configuration.....	72
5.4.1.1 Intel IGD Configuration .....	72
5.4.2 South Bridge Configuration.....	74
5.5 SECURITY.....	75
5.6 BOOT.....	76
5.7 EXIT.....	78
<b>A REGULATORY COMPLIANCE</b> .....	<b>80</b>
<b>B SAFETY PRECAUTIONS</b> .....	<b>86</b>
B.1 SAFETY PRECAUTIONS.....	87
B.1.1 General Safety Precautions .....	87

<i>B.1.2 Anti-static Precautions</i> .....	88
<i>B.1.3 Product Disposal</i> .....	89
<i>B.2 MAINTENANCE AND CLEANING PRECAUTIONS</i> .....	89
<i>B.2.1 Maintenance and Cleaning</i> .....	90
<i>B.2.2 Cleaning Tools</i> .....	90
<b>C BIOS OPTIONS</b> .....	<b>91</b>
<b>D TERMINOLOGY</b> .....	<b>94</b>
<b>E WATCHDOG TIMER</b> .....	<b>98</b>
<b>F HAZARDOUS MATERIALS DISCLOSURE</b> .....	<b>101</b>



# List of Figures

<b>Figure 1-1: TANK-610-BW .....</b>	<b>2</b>
<b>Figure 1-2: TANK-610-BW Front Panel .....</b>	<b>5</b>
<b>Figure 1-3: TANK-610-BW Rear Panel .....</b>	<b>6</b>
<b>Figure 1-4: Physical Dimensions (millimeters).....</b>	<b>7</b>
<b>Figure 3-1: Remove Retention Screws (Bottom Panel) .....</b>	<b>14</b>
<b>Figure 3-2: HDD Bracket Retention Screws .....</b>	<b>15</b>
<b>Figure 3-3: Inserting the HDD .....</b>	<b>15</b>
<b>Figure 3-4: Knockout Holes for Wireless Antenna.....</b>	<b>16</b>
<b>Figure 3-5: PCIe Mini Slot Location .....</b>	<b>16</b>
<b>Figure 3-6: Removing the Retention Screw .....</b>	<b>17</b>
<b>Figure 3-7: Inserting the WLAN Module .....</b>	<b>17</b>
<b>Figure 3-8: Securing WLAN Module and Connecting RF Cables .....</b>	<b>18</b>
<b>Figure 3-9: Securing SMA Connector and External Antenna Installation .....</b>	<b>18</b>
<b>Figure 3-10: Mounting Bracket Retention Screws .....</b>	<b>19</b>
<b>Figure 3-11: Wall-mounting Bracket .....</b>	<b>20</b>
<b>Figure 3-12: Mount the Embedded System.....</b>	<b>21</b>
<b>Figure 3-13: AT/ATX Switch Location.....</b>	<b>22</b>
<b>Figure 3-14: Reset Button Location.....</b>	<b>23</b>
<b>Figure 3-15: Power Button .....</b>	<b>24</b>
<b>Figure 3-16: Audio Connector .....</b>	<b>25</b>
<b>Figure 3-17: HDMI Connection .....</b>	<b>26</b>
<b>Figure 3-18: LAN Connection .....</b>	<b>27</b>
<b>Figure 3-19: DB-9 Serial Port Connection .....</b>	<b>28</b>
<b>Figure 3-20: USB Device Connection .....</b>	<b>29</b>
<b>Figure 3-21: VGA Connector .....</b>	<b>30</b>
<b>Figure 4-1: System Motherboard (Front).....</b>	<b>32</b>
<b>Figure 4-2: System Motherboard (Rear).....</b>	<b>32</b>

# List of Tables

---

<b>Table 1-1: Technical Specifications</b> .....	<b>4</b>
<b>Table 2-1: Package List</b> .....	<b>10</b>
<b>Table 2-2: Optional Items</b> .....	<b>11</b>
<b>Table 4-1: Peripheral Interface Connectors</b> .....	<b>33</b>
<b>Table 4-2: Battery Connector Pinouts (BAT1)</b> .....	<b>33</b>
<b>Table 4-3: BIOS Programming Connector Pinouts (SPI1)</b> .....	<b>33</b>
<b>Table 4-4: Digital I/O Connector Pinouts (DIO1)</b> .....	<b>34</b>
<b>Table 4-5: Debug Connector Pinouts (DEBUGCN1)</b> .....	<b>34</b>
<b>Table 4-6: FPC Connector Pinouts (CN1)</b> .....	<b>34</b>
<b>Table 4-7: EC Programming Connector Pinouts (JSPI1)</b> .....	<b>35</b>
<b>Table 4-8: Keyboard/Mouse Connector Pinouts (KB_MS_CN1)</b> .....	<b>35</b>
<b>Table 4-9: SATA 6Gb/s Drive Connectors Pinouts (SATA1)</b> .....	<b>35</b>
<b>Table 4-10: SATA Power Connector Pinouts (SATA_PWR2)</b> .....	<b>35</b>
<b>Table 4-11: USB 2.0 Connectors Pinouts (USB1)</b> .....	<b>36</b>
<b>Table 4-12: USB 2.0 Connectors Pinouts (USB2)</b> .....	<b>36</b>
<b>Table 4-13: Rear Panel Connectors</b> .....	<b>36</b>
<b>Table 4-14: Audio Jack Pinouts (JAUDIO1)</b> .....	<b>37</b>
<b>Table 4-15: Ethernet and USB2.0 Connectors Pinouts (USB_LAN1)</b> .....	<b>37</b>
<b>Table 4-16: Ethernet and USB2.0 Connectors Pinouts (USB_LAN2)</b> .....	<b>38</b>
<b>Table 4-17: HDMI Connector Pinouts (HDMI1)</b> .....	<b>39</b>
<b>Table 4-18: Power Connector Pinouts (DC_IN1)</b> .....	<b>39</b>
<b>Table 4-19: Power Connector Pinouts (DC_IN2)</b> .....	<b>39</b>
<b>Table 4-20: RS-232 Serial Port Connector Pinouts (COM1-2)</b> .....	<b>39</b>
<b>Table 4-21: RS-232 Serial Port Connector Pinouts (COM3-4)</b> .....	<b>40</b>
<b>Table 4-22: RS-232 Serial Port Connector Pinouts (COM3-4)</b> .....	<b>40</b>
<b>Table 4-23: RS-232 Serial Port Connector Pinouts (COM5-6)</b> .....	<b>41</b>
<b>Table 4-24: VGA Connector Pinouts (VGA1)</b> .....	<b>41</b>
<b>Table 4-25: Buttons, Jumper and Switch</b> .....	<b>42</b>
<b>Table 4-26: AT/ATX Mode Select Switch (AT_SEL1)</b> .....	<b>42</b>
<b>Table 4-27: Clear CMOS Button (J_CMOS1)</b> .....	<b>42</b>

## TANK-610-BW Embedded System

<b>Table 4-28: M-SATA Auto-detect Jumper (MIMI_SW1 ) .....</b>	<b>42</b>
<b>Table 4-29: System Reset Button (RST1).....</b>	<b>43</b>
<b>Table 5-1: BIOS Navigation Keys .....</b>	<b>46</b>

# BIOS Menus

---

BIOS Menu 1: Main .....	47
BIOS Menu 2: Advanced .....	48
BIOS Menu 3: ACPI Configuration .....	49
BIOS Menu 4: F81866 Super IO Configuration .....	50
BIOS Menu 5: Serial Port n Configuration Menu .....	50
BIOS Menu 6: Hardware Health Configuration .....	57
BIOS Menu 7: Secondary Super IO Configuration .....	58
BIOS Menu 8: Serial Port n Configuration Menu .....	59
BIOS Menu 9: RTC Wake Settings .....	62
BIOS Menu 10: Serial Port Console Redirection .....	63
BIOS Menu 11: Console Redirection Settings .....	64
BIOS Menu 12: iEi Feature .....	66
BIOS Menu 13: CPU Configuration .....	67
BIOS Menu 14: IDE Configuration .....	69
BIOS Menu 15: USB Configuration .....	70
BIOS Menu 16: Chipset .....	71
BIOS Menu 17: Host Bridge .....	72
BIOS Menu 18: Graphics Configuration .....	72
BIOS Menu 19: South Bridge .....	74
BIOS Menu 20: Security .....	75
BIOS Menu 21: Boot .....	76
BIOS Menu 22: Exit .....	78

Chapter

1

# Introduction

---

## 1.1 Overview



**Figure 1-1: TANK-610-BW**

The TANK-610-BW is a fanless embedded system for wide range temperature environments. It is powered by the Intel® Celeron® N3160 processor and supports two 204-pin DDR3L 1.35V SDRAM SO-DIMMs (system Max: 8GB). The TANK-610-BW supports dual independent display via one VGA port and one HDMI port. The TANK-610-BW has two GbE LAN ports, four USB 3.0 ports, six RS-232 connectors via DB-9 and two RS-232/422/485 connectors via DB-9.

## 1.2 Features

The TANK-610-BW features are listed below:

- Intel® Celeron® N3160 processor
- Multiple COM ports: six RS-232 and two RS-232/422/485
- VGA and HDMI dual independent display
- mSATA and one x 2.5" SATA storage device
- Wide range temperature

## TANK-610-BW Embedded System

### 1.3 Technical Specifications

The TANK-610-BW technical specifications are listed in **Table 1-1**.

Specifications	
Chassis	
Color	Black C + Silver
Dimension (WxDxH)	184 x 200.6 x 58.2 mm
System Fan	Fanless
Chassis Construction	Extruded aluminum alloy
Motherboard	
CPU	Intel® Celeron® N3160 processor (up to 2.24GHz, quad-core, 2MB cache, TDP=6W)
Chipset	SoC
System Memory	2 x 204-pin DDR3L 1.35V SDRAM SO-DIMM (system Max: 8GB)
Storage	
Hard Drive	1 x 2.5" SATA 6Gb/s HDD/SSD Bay
mSATA	1 x mSATA (SATA2 signal)
I/O interfaces	
USB 3.0	4 x USB 3.0
Ethernet	2 x RJ-45 PCIe GbE by Intel® I210-IT
COM Port	6 x RS-232 2 x RS-232/422/485
Display	1 x VGA 1 x HDMI
Resolution	VGA: Up to 2560 x 1600 HDMI: Up to 3840 x 2160
Audio	1 x Line-out, 1 x Mic-in
Wireless	1 x 802.11 b/g/n (optional)

<b>Specifications</b>	
<b>Expansions</b>	
PCIe Mini	1 x Full size (support mSATA, co-lay SATA), 1 x Half size
<b>Power</b>	
Power Input	DC Jack: 9 V~36 V DC
Power Consumption	12 V@1.49 A (Intel® Celeron® N3160 with 4 GB DDR3L memory)
<b>Reliability</b>	
Mounting	Wall mount, VESA 100
Operating Temperature	-40°C ~ 60°C with air flow (SSD), 10% ~ 95%, non-condensing
Storage Temperature	-40°C ~ 80°C
Operating Shock	Half-sine wave shock 5G, 11ms, 100 shocks per axis
Operating Vibration	MIL-STD-810F 514.6C-1 (with SSD)
Weight (Net/Gross )	2.2 Kg / 3 Kg
Safety/EMC	CE / FCC
<b>OS</b>	
Supported OS	Microsoft® Windows 8 Embedded, Microsoft® Windows® Embedded Standard 7 E

**Table 1-1: Technical Specifications**



## TANK-610-BW Embedded System

## 1.4 Front Panel

The front panel of the TANK-610-BW has the following features (Figure 1-2):

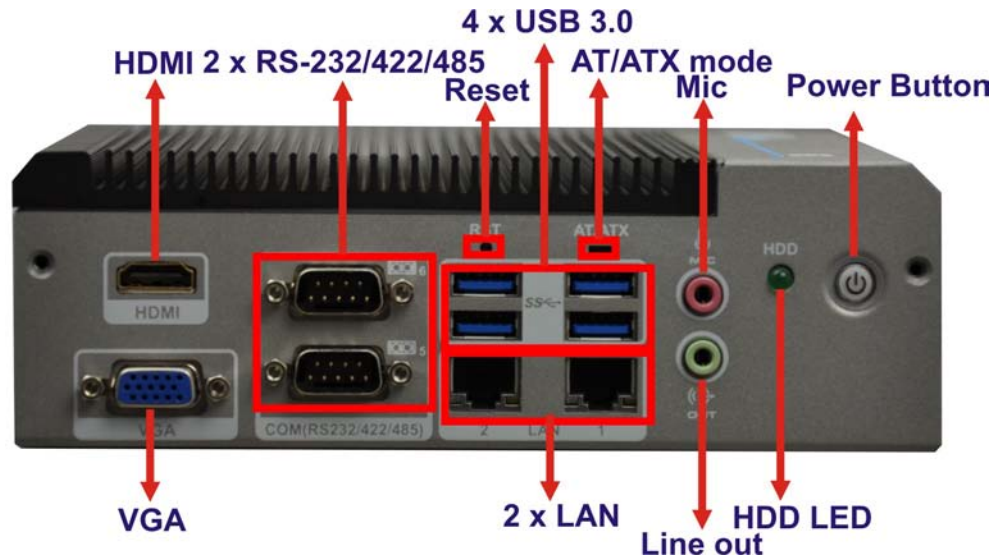

Figure 1-2: TANK-610-BW Front Panel

Connectors and buttons on the front panel include the following:

- 1 x AT/ATX mode switch
- 1 x HDD LED
- 1 x HDMI port
- 2 x LAN ports by RJ-45
- 1 x Line-out port (green)
- 1 x Mic-in port (pink)
- 1 x Power button
- 1 x Reset button
- 2 x RS-232/422/485 serial ports by DB-9
- 4 x USB 3.0 ports
- 1 x VGA port

## 1.5 Rear Panel

The rear panel of the TANK-610-BW has the following features (**Figure 1-2**):

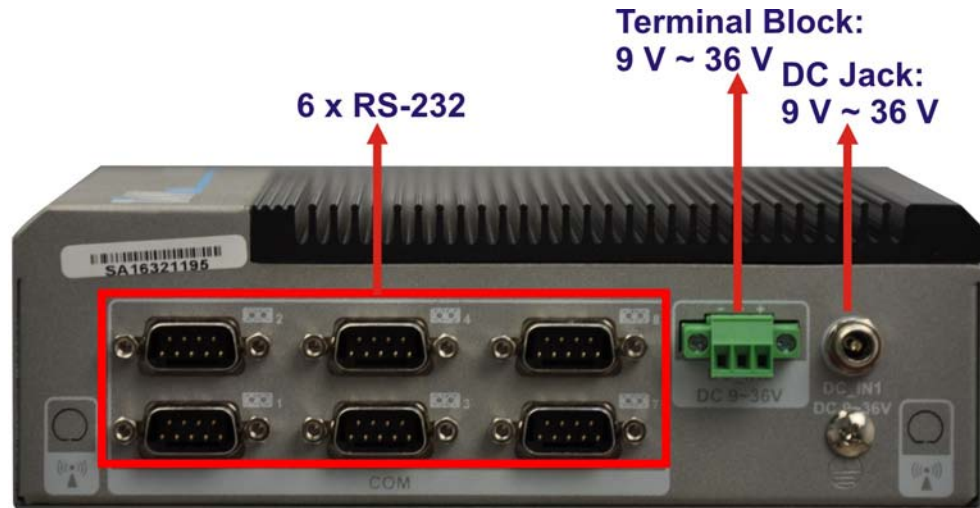

**Figure 1-3: TANK-610-BW Rear Panel**

Connectors and buttons on the front panel include the following:

- 1 x 9 V ~ 36 V DC Jack
- 6 x RS-232 serial ports by DB-9
- 1 x 9 V ~ 36 V Terminal Block

## TANK-610-BW Embedded System

### 1.6 Dimensions

The physical dimensions are shown below:

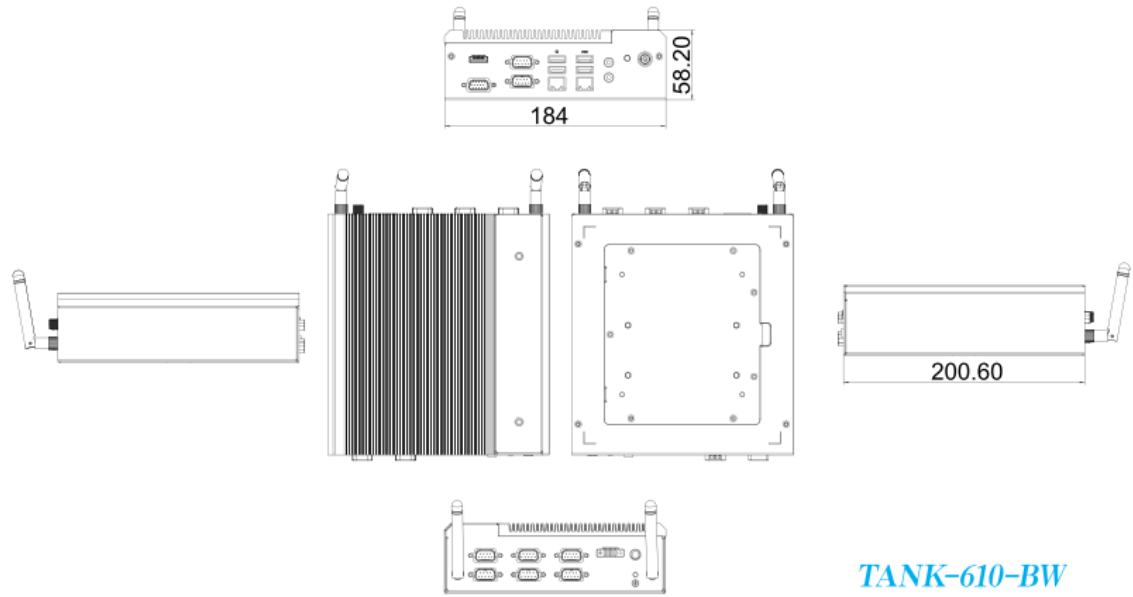

*TANK-610-BW*

**Figure 1-4: Physical Dimensions (millimeters)**

Chapter

2

# Unpacking

---

## TANK-610-BW Embedded System

### 2.1 Unpacking

To unpack the embedded system, follow the steps below:

- Step 1:** Use box cutters, a knife or a sharp pair of scissors that seals the top side of the external (second) box.
- Step 2:** Open the external (second) box.
- Step 3:** Use box cutters, a knife or a sharp pair of scissors that seals the top side of the internal (first) box.
- Step 4:** Lift the system out of the boxes.
- Step 5:** Remove both polystyrene ends, one from each side.
- Step 6:** Make sure all the components listed in the packing list are present.

### 2.2 Packing List



#### NOTE:

If any of the components listed in the checklist below are missing, do not proceed with the installation. Contact the IEI reseller or vendor the TANK-610-BW was purchased from or contact an IEI sales representative directly by sending an email to [sales@ieiworld.com](mailto:sales@ieiworld.com).

The TANK-610-BW is shipped with the following components:

Quantity	Item and Part Number	Image
1	TANK-610-BW	



Quantity	Item and Part Number	Image
1	Power Adapter	
1	Power Cord	
4	Wall Mounting Bracket Screws	
2	Wall Mounting Brackets	
4	Screw Set	
1	One Key Recovery CD	
1	Utility CD	

**Table 2-1: Package List**

TANK-610-BW Embedded System

2.3 Optional Items

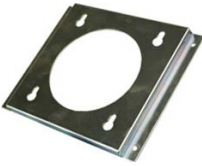
The following are optional component(s) which may be separately purchased:

<p>AFLWK-19 (VESA 100 mount kit)</p>	
<p>EMB-WIFI-KIT01-R11 (1T1R Wi-Fi module kit for embedded system , IEEE802.11b/g/n, 1 x Wi-Fi module, 2 x RF cable, 2 x Antenna, RoHs)</p>	

**Table 2-2: Optional Items**

Chapter

3

# Installation

---



### 3.1 Anti-static Precautions

---

**WARNING:**

Failure to take ESD precautions during the maintenance of the TANK-610-BW may result in permanent damage to the TANK-610-BW and severe injury to the user.

---

Electrostatic discharge (ESD) can cause serious damage to electronic components, including the WAFER series motherboard and the power module. (Dry climates are especially susceptible to ESD.) It is therefore critical that whenever the TANK-610-BW is opened and any electrical component handled, the following anti-static precautions are strictly adhered to.

- **Wear an anti-static wristband:** Wearing a simple anti-static wristband can help to prevent ESD from damaging the board.
- **Self-grounding:** Before handling the board, touch any grounded conducting material. During the time the board is handled, frequently touch any conducting materials that are connected to the ground.
- **Use an anti-static pad:** When configuring the TANK-610-BW, place it on an anti-static pad. This reduces the possibility of ESD damaging the TANK-610-BW.

### 3.2 Installation Precautions

During installation, be aware of the precautions below:

- **Read the user manual:** The user manual provides a complete description of the TANK-610-BW, installation instructions and configuration options.
- **DANGER! Disconnect Power:** Power to the TANK-610-BW must be disconnected during the installation process, or before any attempt is made to access the rear panel. Electric shock and personal injury might occur if the rear panel of the TANK-610-BW is opened while the power cord is still connected to an electrical outlet.

- **Qualified Personnel:** The TANK-610-BW must be installed and operated only by trained and qualified personnel. Maintenance, upgrades, or repairs may only be carried out by qualified personnel who are familiar with the associated dangers.
- **Air Circulation:** Make sure there is sufficient air circulation when installing the TANK-610-BW. The TANK-610-BW's cooling vents must not be obstructed by any objects. Blocking the vents can cause overheating of the TANK-610-BW. Leave at least 5 cm of clearance around the TANK-610-BW to prevent overheating.
- **Grounding:** The TANK-610-BW should be properly grounded. The voltage feeds must not be overloaded. Adjust the cabling and provide external overcharge protection per the electrical values indicated on the label attached to the back of the TANK-610-BW.

### 3.3 Hard Disk Drive (HDD) Installation

To install the hard drive, please follow the steps below:

**Step 1:** Remove seven retention screws from the bottom panel, as shown in **Figure 3-1**.



**Figure 3-1: Remove Retention Screws (Bottom Panel)**

**Step 2:** Remove the bottom cover from the device. (**Figure 3-2**)

## TANK-610-BW Embedded System



**Figure 3-2: HDD Bracket Retention Screws**

**Step 3:** Slide the HDD to the HDD bracket and secure the HDD to the HDD bracket using four retention screws (**Figure 3-3**).



**Figure 3-3: Inserting the HDD**

**Step 4:** Reinstall the bottom cover.

### 3.4 Wireless LAN Module Installation (Optional)

To install the optional wireless LAN (WLAN) module, please follow the steps below.

**Step 1:** Remove the bottom surface. See **Section 3.3**.

**Step 2:** Remove the two knockout holes for antenna installation. The two knockout holes are located on the rear panel of the TANK-610-BW as shown in **Figure 3-4**.



**Figure 3-4: Knockout Holes for Wireless Antenna**

**Step 3:** Locate the PCIe Mini slot (Figure 3-5).

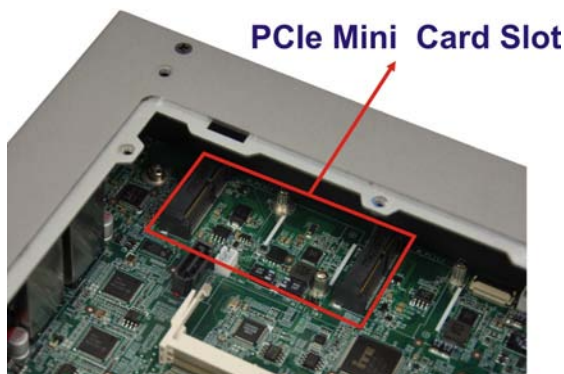

**Figure 3-5: PCIe Mini Slot Location**

**Step 4:** Remove the retention screw. Remove the retention screw for half-size card installation as shown in **Figure 3-6**.

## TANK-610-BW Embedded System

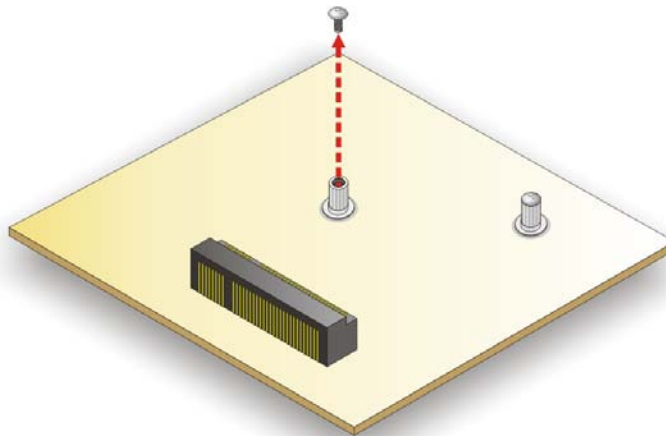

**Figure 3-6: Removing the Retention Screw**

**Step 5:** **Insert into the socket at an angle.** Line up the notch on the WLAN module with the notch on the slot. Slide the WLAN module into the slot at an angle of about 20° (Figure 3-7).

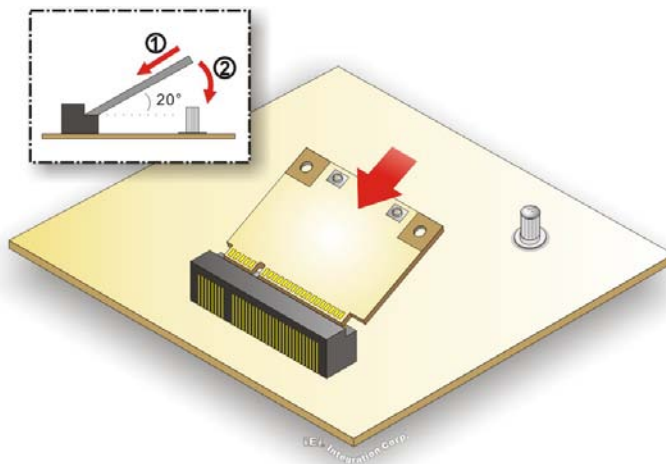

**Figure 3-7: Inserting the WLAN Module**

**Step 6:** **Secure the WLAN module.** Secure the WLAN module with the retention screw previously removed (Figure 3-8).

**Step 7:** **Connect the two RF cables** to the antenna connectors on the WLAN module (Figure 3-8).

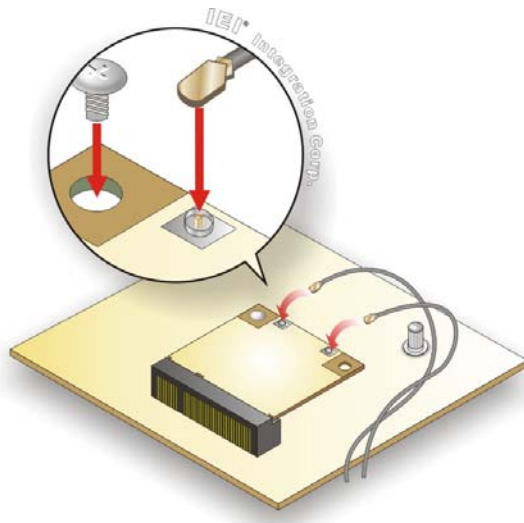

**Figure 3-8: Securing WLAN Module and Connecting RF Cables**

**Step 8:** Remove the nut and washer from the SMA connector at the other end of the RF cable.

**Step 9:** Insert the SMA connector to the antenna connector holes on the rear panel.

**Step 10:** Secure the SMA connector by inserting the washer and tightening it with nut.

**Step 11:** Install the external antenna.

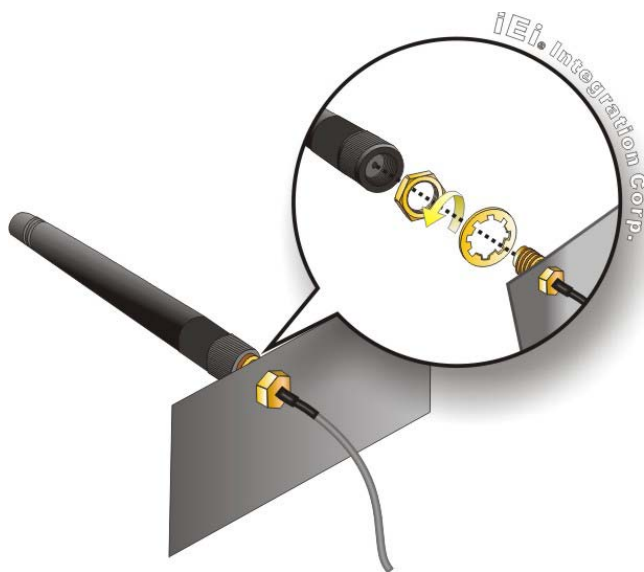

**Figure 3-9: Securing SMA Connector and External Antenna Installation**

## TANK-610-BW Embedded System

### 3.5 Mounting the System

There are two ways to mount the TANK-610-BW. The mounting instructions are described below.

#### 3.5.1 Mounting with Mounting Brackets

To mount the embedded system onto a wall or some other surface using the two mounting brackets, please follow the steps below.

**Step 1:** Turn the embedded system to the bottom panel.

**Step 2:** Align the two retention screw holes in each bracket with the corresponding retention screw holes on the bottom panel (**Figure 3-10**).

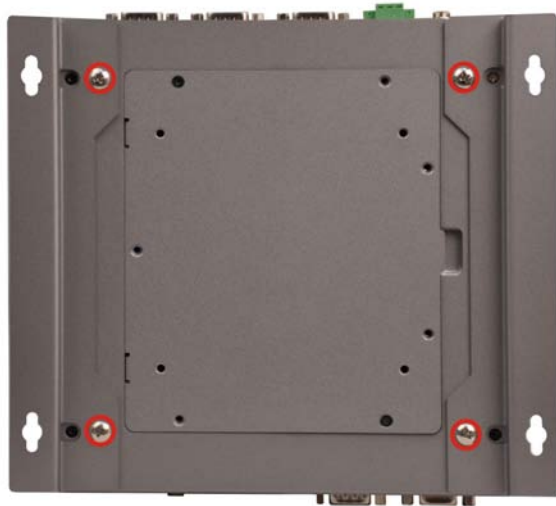

**Figure 3-10: Mounting Bracket Retention Screws**

**Step 3:** Secure the brackets to the system by inserting two retention screws into each bracket (**Figure 3-10**).

**Step 4:** Drill holes in the intended installation surface.

**Step 5:** Align the mounting holes in the sides of the mounting brackets with the predrilled holes in the mounting surface.

**Step 6:** Insert four retention screws, two in each bracket, to secure the system to the wall.

### 3.5.2 Mounting with VESA Mount Kit (Optional)

To mount the embedded system onto a wall using the optional VESA 100 wall mount kit, please follow the steps below.

**Step 1:** Select the location on the wall for the wall-mounting bracket.

**Step 2:** Carefully mark the locations of the four bracket screw holes on the wall.

**Step 3:** Drill four pilot holes at the marked locations on the wall for the bracket retention screws.

**Step 4:** Align the wall-mounting bracket screw holes with the pilot holes.

**Step 5:** Secure the mounting-bracket to the wall by inserting the retention screws into the four pilot holes and tightening them (**Figure 3-11**).

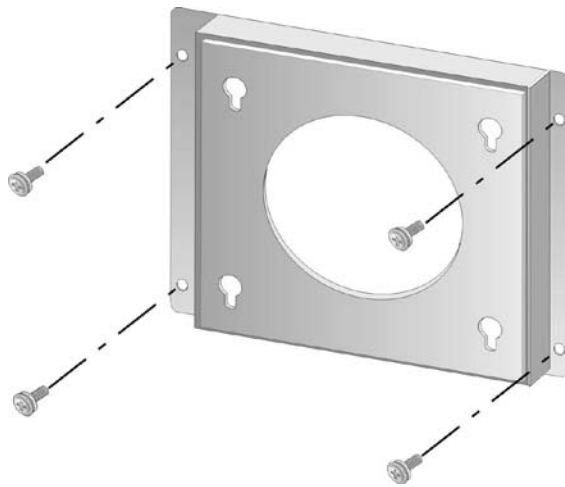

**Figure 3-11: Wall-mounting Bracket**

**Step 6:** Insert the four monitor mounting screws provided in the wall mounting kit into the four screw holes on the bottom panel of the system and tighten until the screw shank is secured against the bottom panel (**Figure 3-12**).



## TANK-610-BW Embedded System

- Step 7:** Align the mounting screws on the TANK-610-BW bottom panel with the mounting holes on the bracket.
- Step 8:** Carefully insert the screws through the holes and gently pull the monitor downwards until the TANK-610-BW rests securely in the slotted holes (**Figure 3-12**). Ensure that all four of the mounting screws fit snugly into their respective slotted holes.



### NOTE:

In the diagram below the bracket is already installed on the wall.

---

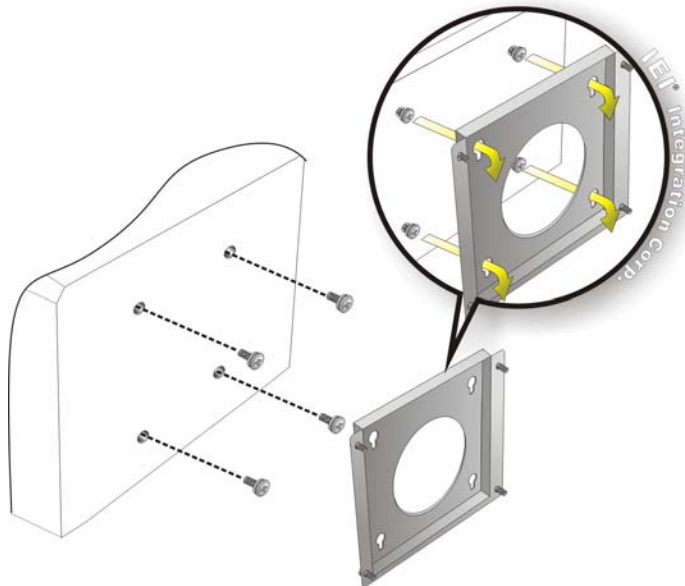
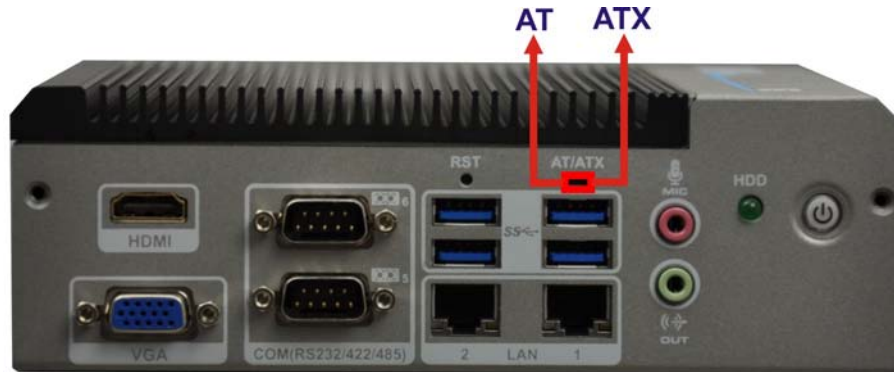

**Figure 3-12: Mount the Embedded System**

### 3.6 AT/ATX Mode Selection

AT or ATX power mode can be used on the TANK-610-BW. The selection is made through an AT/ATX switch located on the bottom panel. To select AT mode or ATX mode, follow the steps below.

- Step 1:** Locate the AT/ATX switch on the bottom panel (**Figure 3-13**).



**Figure 3-13: AT/ATX Switch Location**

**Step 2:** Adjust the AT/ATX switch.

### 3.6.1 AT Power Mode

With the AT mode selected, the power is controlled by a central power unit rather than a power switch. The TANK-610-BW system turns on automatically when the power is connected. The AT mode benefits a production line to control multiple systems from a central management center and other applications including:

- ATM
- Self-service kiosk
- Plant environment monitoring system
- Factory automation platform
- Manufacturing shop flow

### 3.6.2 ATX Power Mode

With the ATX mode selected, the TANK-610-BW system goes in a standby mode when it is turned off. The system can be easily turned on via network or a power switch in standby mode. Remote power control is perfect for advertising applications since the broadcasting time for each system can be set individually and controlled remotely. Other possible application includes

- Security surveillance
- Point-of-Sale (POS)
- Advertising terminal

### 3.7 Reset the System

The reset button enables user to reboot the system when the system is turned on. To reboot the system, follow the steps below.

**Step 1:** Locate the reset button on the bottom panel (**Figure 3-14**).



**Figure 3-14: Reset Button Location**

**Step 2:** Press the reset button.

### 3.8 Powering On/Off the System



#### **WARNING:**

Make sure a power supply with the correct input voltage is being fed into the system. Incorrect voltages applied to the system may cause damage to the internal electronic components and may also cause injury to the user.

- **Power on** the system: press the power button for 3 seconds
- **Power off** the system: press the power button for 6 seconds



Figure 3-15: Power Button

### 3.9 External Peripheral Device Connection

The following external peripheral devices can be connected to the external peripheral interface connectors.

- Audio devices
- HDMI devices
- RJ-45 Ethernet cable
- Serial port devices
- USB devices
- VGA monitor

To install these devices, connect the corresponding cable connector from the actual device to the corresponding TANK-610-BW external peripheral interface connector making sure the pins are properly aligned.

#### 3.9.1 Audio Connection

The audio jacks on the external audio connector enable the TANK-610-BW to be connected to a stereo sound setup. To install the audio devices, follow the steps below.

**Step 1: Identify the audio plugs.** The plugs on your home theater system or speakers may not match the colors on the rear panel. If audio plugs are plugged into the wrong jacks, sound quality will be very bad.

**Step 2: Plug the audio plugs into the audio jacks.** Plug the audio plugs into the audio

## TANK-610-BW Embedded System

jacks. If the plugs on your speakers are different, an adapter will need to be used to plug them into the audio jacks.

- **Line Out port (Lime):** Connects to a headphone or a speaker.
- **Microphone (Pink):** Connects to a microphone.

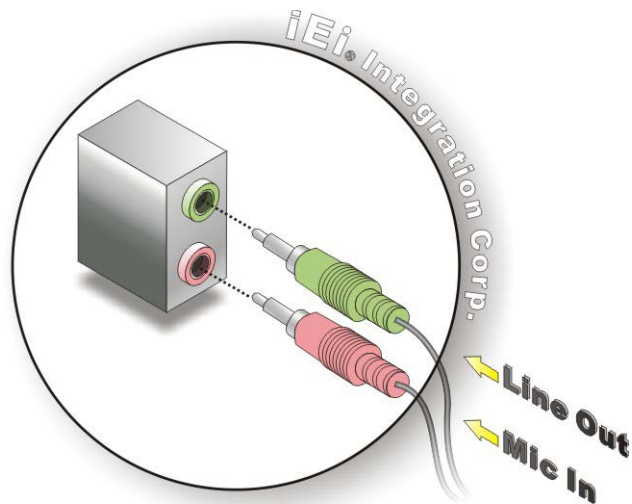

**Figure 3-16: Audio Connector**

**Step 3: Check audio clarity.** Check that the sound is coming through the right speakers by adjusting the balance front to rear and left to right.

### 3.9.2 HDMI Device Connection

The HDMI connector transmits a digital signal to compatible HDMI display devices such as a TV or computer screen. To connect the HDMI cable to the TANK-610-BW, follow the steps below.

**Step 1: Locate the HDMI connector.** The location is shown in **Chapter 1**.

**Step 2: Align the connector.** Align the HDMI connector with the HDMI port. Make sure the orientation of the connector is correct.

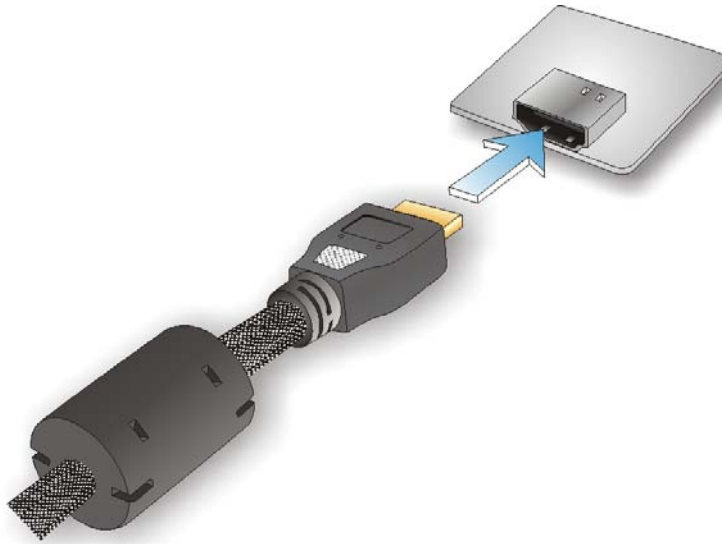

**Figure 3-17: HDMI Connection**

**Step 3: Insert the HDMI connector.** Gently insert the HDMI connector. The connector should engage with a gentle push. If the connector does not insert easily, check again that the connector is aligned correctly, and that the connector is being inserted with the right way up.

### 3.9.3 LAN Connection

There are two external RJ-45 LAN connectors on the TANK-610-BW. The RJ-45 connector enables connection to an external network. To connect a LAN cable with an RJ-45 connector, please follow the instructions below.

**Step 1: Locate the RJ-45 connectors.** The location of the LAN connector is shown in **Chapter 1**.

**Step 2: Align the connectors.** Align the RJ-45 connector on the LAN cable with one of the RJ-45 connectors on the TANK-610-BW. See **Figure 3-18**.

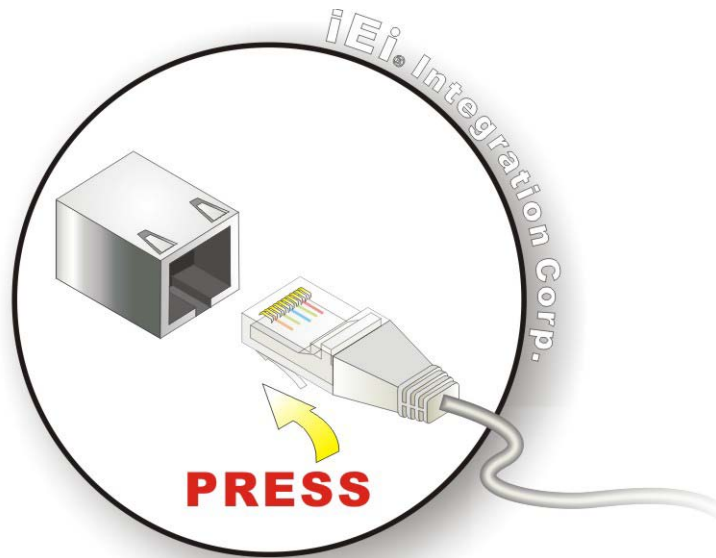

**Figure 3-18: LAN Connection**

**Step 3:** Insert the LAN cable RJ-45 connector. Once aligned, gently insert the LAN cable RJ-45 connector into the external interface.

#### 3.9.4 Serial Device Connection

There are six RS-232 connectors via DB-9, two RS-232/422/485 connectors via DB-9 for serial device connection. Follow the steps below to connect a serial device to the TANK-610-BW.

**Step 1:** Locate the DB-9 connector. The locations of the DB-9 connectors are shown in **Chapter 1**.

**Step 2:** Insert the serial connector. Insert the DB-9 connector of a serial device into the DB-9 connector on the bottom panel. See **Figure 3-19**.

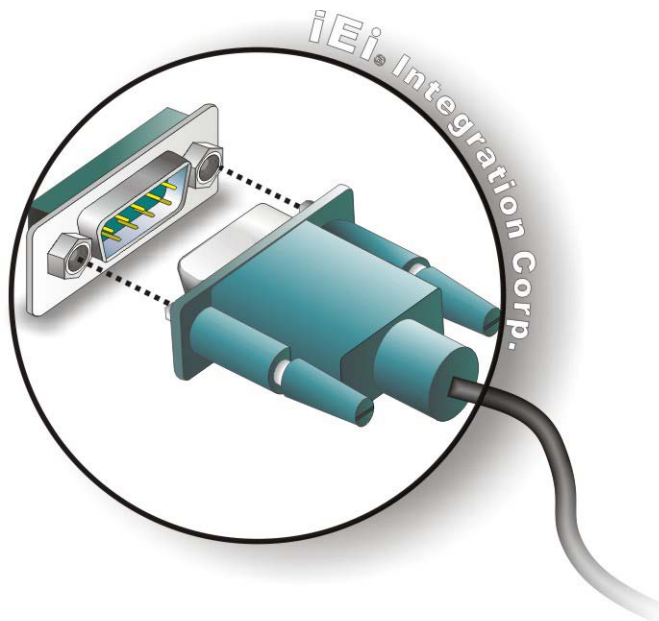

**Figure 3-19: DB-9 Serial Port Connection**

**Step 3: Secure the connector.** Secure the serial device connector to the external interface by tightening the two retention screws on either side of the connector.

### 3.9.5 USB Device Connection

There are four USB 3.0 connectors on the TANK-610-BW. To connect a USB device, please follow the instructions below.

**Step 1: Locate the USB connectors.** The locations of the USB connectors are shown in **Chapter 1**.

**Step 2: Align the connectors.** Align the USB device connector with one of the connectors on the TANK-610-BW. See **Figure 3-20**.



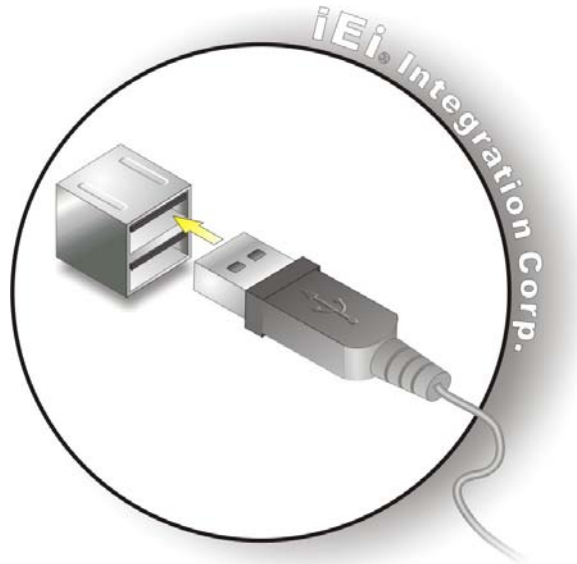

**Figure 3-20: USB Device Connection**

**Step 3:** **Insert the device connector.** Once aligned, gently insert the USB device connector into the onboard connector.

### 3.9.6 VGA Monitor Connection

The TANK-610-BW has a single female DB-15 connector on the external peripheral interface panel. The DB-15 connector is connected to a CRT or VGA monitor. To connect a monitor to the TANK-610-BW, please follow the instructions below.

- Step 1:** **Locate the female DB-15 connector.** The location of the female DB-15 connector is shown in **Chapter 1**.
- Step 2:** **Align the VGA connector.** Align the male DB-15 connector on the VGA screen cable with the female DB-15 connector on the external peripheral interface.
- Step 3:** **Insert the VGA connector.** Once the connectors are properly aligned with the insert the male connector from the VGA screen into the female connector on the TANK-610-BW. See **Figure 3-21**.

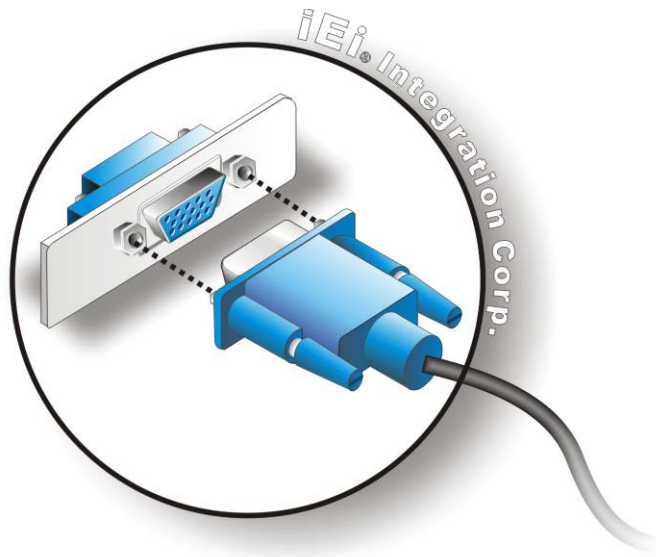

**Figure 3-21: VGA Connector**

**Step 4: Secure the connector.** Secure the DB-15 VGA connector from the VGA monitor to the external interface by tightening the two retention screws on either side of the connector.

Chapter

4

# System Motherboard

---

## 4.1 Overview

This chapter details all the jumpers and connectors of the system motherboard.

### 4.1.1 Layout

The figures below show all the connectors and jumpers of the system motherboard. The Pin 1 locations of the on-board connectors are also indicated in the diagram below.

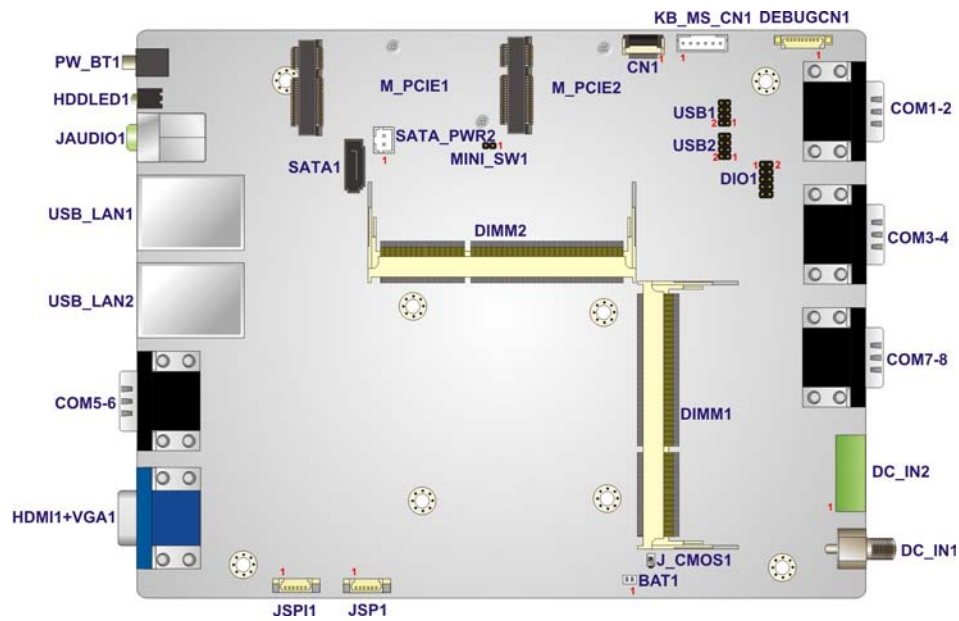

**Figure 4-1: System Motherboard (Front)**

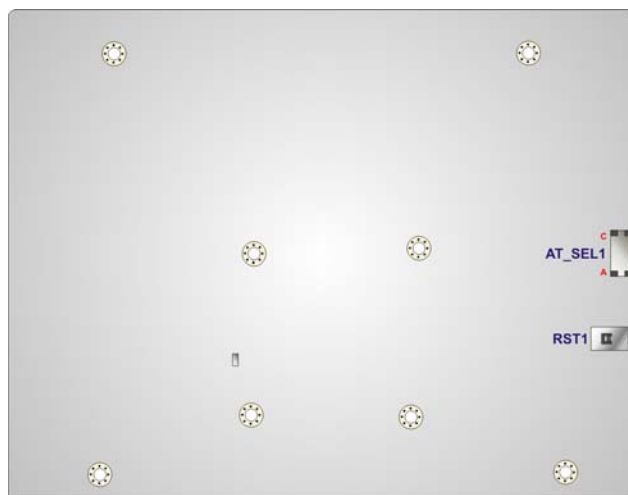

**Figure 4-2: System Motherboard (Rear)**

## 4.2 Internal Peripheral Connectors

The table below shows a list of the internal peripheral interface connectors on the system motherboard. Pinouts of these connectors can be found in the following sections.

Connector	Type	Label
Battery connector	2-pin wafer	BAT1
BIOS programming connector	6-pin wafer	SPI1
Digital I/O connector	10-pin header	DIO1
Debug connector	9-pin wafer	DEBUGCN1
FPC connector	20-pin FPC connector	CN1
EC programming connector	6-pin wafer	JSPI1
Keyboard/mouse connector	6-pin wafer	KB_MS_CN1
SATA 6Gb/s drive connectors	7-pin SATA connector	SATA1
SATA power connector	2-pin wafer	SATA_PWR2
USB 2.0 Connectors	8-pin header	USB1, USB2

**Table 4-1: Peripheral Interface Connectors**

### 4.2.1 Battery Connector (BAT1)

PIN NO.	DESCRIPTION
1	VBATT
2	GND

**Table 4-2: Battery Connector Pinouts (BAT1)**

### 4.2.2 BIOS Programming Connector (SPI1)

PIN NO.	DESCRIPTION	PIN NO.	DESCRIPTION
1	SPI_VCC	2	SPI_2N_CS#
3	SPI_2N_MISO	4	SPI_2N_CLK
5	SPI_2N_MOSI	6	GND

**Table 4-3: BIOS Programming Connector Pinouts (SPI1)**

#### 4.2.3 Digital I/O Connector (DIO1)

PIN NO.	DESCRIPTION	PIN NO.	DESCRIPTION
1	GND	2	P5V
3	DOUT3	4	DOUT2
5	DOUT1	6	DOUT0
7	DIN3	8	DIN2
9	DIN1	10	DIN0

**Table 4-4: Digital I/O Connector Pinouts (DIO1)**

#### 4.2.4 Debug Connector (DEBUGCN1)

PIN NO.	DESCRIPTION	PIN NO.	DESCRIPTION
1	BUF_PLT_RST#	2	CLK_PCI_DBG
3	GND	4	LPC_AD3
5	LPC_AD2	6	LPC_AD1
7	LPC_AD0	8	LPC_FRAME#
9	P3V3		

**Table 4-5: Debug Connector Pinouts (DEBUGCN1)**

#### 4.2.5 FPC Connector (CN1)

PIN NO.	DESCRIPTION	PIN NO.	DESCRIPTION
1	KSI0	2	KSO0
3	KSO1	4	KSO2
5	KSO3	6	KSO4
7	KSO5	8	KSO6
9	KSO7	10	KSO8
11	KSO9	12	KSO10
13	KSO12	14	KSI1
15	KSO11	16	KSI2
17	KSI3	18	GND
19	GND	20	GND

**Table 4-6: FPC Connector Pinouts (CN1)**

#### 4.2.6 EC Programming Connector (JSPI1)

PIN NO.	DESCRIPTION	PIN NO.	DESCRIPTION
1	+V3.3M_SPI_CON_EC	2	SPI_CS#0_CN_EC
3	SPI_SO_SW_EC	4	SPI_CLK_SW_EC
5	SPI_SI_SW_EC	6	GND

**Table 4-7: EC Programming Connector Pinouts (JSPI1)**

#### 4.2.7 Keyboard/Mouse Connector (KB\_MS\_CN1)

PIN NO.	DESCRIPTION	PIN NO.	DESCRIPTION
1	+5V_KBMS	2	MSDATA
3	MSCLK	4	KBDATA
5	KBCLK	6	KBGND

**Table 4-8: Keyboard/Mouse Connector Pinouts (KB\_MS\_CN1)**

#### 4.2.8 SATA 6Gb/s Drive Connectors (SATA1)

PIN NO.	DESCRIPTION	PIN NO.	DESCRIPTION
1	GND	2	SATA0_T_TX+
3	SATA0_T_TX-	4	GND
5	SATA0_T_RX-	6	SATA0_T_RX+
7	GND		

**Table 4-9: SATA 6Gb/s Drive Connectors Pinouts (SATA1)**

#### 4.2.9 SATA Power Connector (SATA\_PWR2)

PIN NO.	DESCRIPTION	PIN NO.	DESCRIPTION
1	+5V	2	GND

**Table 4-10: SATA Power Connector Pinouts (SATA\_PWR2)**

#### 4.2.10 USB 2.0 Connectors (USB1)

PIN NO.	DESCRIPTION	PIN NO.	DESCRIPTION
1	+VCC_USB34	2	GND

3	-DATA_USB3	4	+DATA_USB4
5	+DATA_USB3	6	-DATA_USB4
7	GND	8	+VCC_USB34

**Table 4-11: USB 2.0 Connectors Pinouts (USB1)**

#### 4.2.11 USB 2.0 Connectors (USB2)

PIN NO.	DESCRIPTION	PIN NO.	DESCRIPTION
1	+VCC_USB12	2	GND
3	-DATA_USB1	4	+DATA_USB2
5	+DATA_USB1	6	-DATA_USB2
7	GND	8	+VCC_USB12

**Table 4-12: USB 2.0 Connectors Pinouts (USB2)**

### 4.3 External Interface Panel Connectors

The table below shows a list of the external interface panel connectors on the system motherboard. Pinouts of these connectors can be found in the following sections.

Connector	Type	Label
Audio jack (mic, line-out)	Audio jack	JAUDIO1
Ethernet and USB2.0 connectors	RJ-45, USB 2.0 port	USB_LAN1, USB_LAN2
HDMI connector	Type A	HDMI1
Power connector	DC jack	DC_IN1
Power connector	3-pin terminal block	DC_IN2
RS-232/422/485 serial port connectors	DB-9	COM5-6
RS-232 serial port connectors	DB-9	COM1-2, COM3-4, COM7-8
RS-232 serial port connectors	DB-78	CN2
VGA connector	DB-15	VGA1

**Table 4-13: Rear Panel Connectors**



### 4.3.1 Audio Jack (JAUDIO1)

PIN NO.	DESCRIPTION	PIN NO.	DESCRIPTION
1	Analog_GND	2	LMIC1-L
3	Analog_GND	4	MIC1-JD
5	LMIC1-R	22	LINE_OUTL
23	Analog_GND	24	FRONT-JD
25	LINE_OUTR		

**Table 4-14: Audio Jack Pinouts (JAUDIO1)**

### 4.3.2 Ethernet and USB2.0 Connectors (USB\_LAN1)

PIN NO.	DESCRIPTION	PIN NO.	DESCRIPTION
R1	1_5VLAN1	R2	TRD1P0
R3	TRD1N0	R4	TRD1P1
R5	TRD1N1	R6	TRD1P2
R7	TRD1N2	R8	TRD1P3
R9	TRD1N3	R10	GND
L1	L1_100-	L2	L1_1000-
L3	L1_LINK_ACT-	L4	+V3.3LAN1
G1	GND_IOL1	G2	GND_IOL1
G3	GND_IOL1	G4	GND_IOL1
G5	GND_IOL1	G6	GND_IOL1
G7	GND_IOL1	G8	GND_IOL1
U1	+USB3_PWR1	U2	USB20_C_N0
U3	USB20_C_P0	U4	GND
U5	USB3_RX1_DN	U6	USB3_RX1_DP
U7	GND	U8	USB3_TX1_DN_C
U9	USB3_TX1_DP_C	U10	+USB3_PWR1
U11	USB20_C_N1	U12	USB20_C_P1
U13	GND	U14	USB3_RX2_DN
U15	USB3_RX2_DP	U16	GND
U17	USB3_TX2_DN_C	U18	USB3_TX2_DP_C

**Table 4-15: Ethernet and USB2.0 Connectors Pinouts (USB\_LAN1)**

### 4.3.3 Ethernet and USB2.0 Connectors (USB\_LAN2)

PIN NO.	DESCRIPTION	PIN NO.	DESCRIPTION
R1	1_5VLAN2	R2	TRD2P0
R3	TRD2N0	R4	TRD2P1
R5	TRD2N1	R6	TRD2P2
R7	TRD2N2	R8	TRD2P3
R9	TRD2N3	R10	GND
L1	L2_100-	L2	L2_1000-
L3	L2_LINK_ACT-	L4	+V3.3LAN2
G1	GND_IOL2	G2	GND_IOL2
G3	GND_IOL2	G4	GND_IOL2
G5	GND_IOL2	G6	GND_IOL2
G7	GND_IOL2	G8	GND_IOL2
U1	+USB3_PWR2	U2	USB20_C_N2
U3	USB20_C_P2	U4	GND
U5	USB3_RX3_DN	U6	USB3_RX3_DP
U7	GND	U8	USB3_TX3_DN_C
U9	USB3_TX3_DP_C	U10	+USB3_PWR2
U11	USB20_C_N3	U12	USB20_C_P3
U13	GND	U14	USB3_RX4_DN
U15	USB3_RX4_DP	U16	GND
U17	USB3_TX4_DN_C	U18	USB3_TX4_DP_C

**Table 4-16: Ethernet and USB2.0 Connectors Pinouts (USB\_LAN2)**

### 4.3.4 HDMI Connector (HDMI1)

PIN NO.	DESCRIPTION	PIN NO.	DESCRIPTION
1	HDMI1_DATA2_C	2	GND
3	HDMI1_DATA2#_C	4	HDMI1_DATA1_C
5	GND	6	HDMI1_DATA1#_C
7	HDMI1_DATA0_C	8	GND
9	HDMI1_DATA0#_C	10	HDMI1_CLK_C
11	GND	12	HDMI1_CLK#_C

13	NC	14	NC
15	HDMI1_SCL	16	HDMI1_SDA
17	GND	18	HDMI1_PWR
19	HDMI1_HPD		

**Table 4-17: HDMI Connector Pinouts (HDMI1)**

#### 4.3.5 Power Connector (DC\_IN1)

PIN NO.	DESCRIPTION	PIN NO.	DESCRIPTION
1	DC_IN	2	GND
3	GND		

**Table 4-18: Power Connector Pinouts (DC\_IN1)**

#### 4.3.6 Power Connector (DC\_IN2)

PIN NO.	DESCRIPTION	PIN NO.	DESCRIPTION
1	DC_IN	2	GND
3	GND		

**Table 4-19: Power Connector Pinouts (DC\_IN2)**

#### 4.3.7 RS-232 Serial Port Connector (COM1-2)

PIN NO.	DESCRIPTION	PIN NO.	DESCRIPTION
1	-NDCD1	2	NSIN1
3	NSOUT1	4	-NDTR1
5	GND	6	-NDSR1
7	-NRTS1	8	-NCTS1
9	-XRI1	10	-NDCD2
11	NSIN2	12	NSOUT2
13	-NDTR2	14	GND
15	-NDSR2	16	-NRTS2
17	-NCTS2	18	-XRI2

**Table 4-20: RS-232 Serial Port Connector Pinouts (COM1-2)**

#### 4.3.8 RS-232 Serial Port Connector (COM3-4)

PIN NO.	DESCRIPTION	PIN NO.	DESCRIPTION
1	-ND3D3	2	NSIN3
3	NSOUT3	4	-NDTR3
5	GND	6	-NDSR3
7	-NRTS3	8	-NCTS3
9	-XRI3	10	-ND3D4
11	NSIN4	12	NSOUT4
13	-NDTR4	14	GND
15	-NDSR4	16	-NRTS4
17	-NCTS4	18	-XRI4

**Table 4-21: RS-232 Serial Port Connector Pinouts (COM3-4)**

#### 4.3.9 RS-232 Serial Port Connector (COM7-8)

PIN NO.	DESCRIPTION	PIN NO.	DESCRIPTION
1	-ND3D3	2	NSIN3
3	NSOUT3	4	-NDTR3
5	GND	6	-NDSR3
7	-NRTS3	8	-NCTS3
9	-XRI3	10	-ND3D4
11	NSIN4	12	NSOUT4
13	-NDTR4	14	GND
15	-NDSR4	16	-NRTS4
17	-NCTS4	18	-XRI4

**Table 4-22: RS-232 Serial Port Connector Pinouts (COM3-4)**

#### 4.3.10 RS-232 Serial Port Connector (COM5-6)

PIN NO.	RS-232	RS-422	RS-485
1	COM5_D3D#	TXD422#	TXD485#
2	COM5_SIN#	TXD422+	TXD485+
3	COM5_SOUT#	RXD422+	NA

4	COM5_DTR#	RXD422#	NA
5	GND	NA	NA
6	COM5_DSR#	NA	NA
7	COM5_RTS#	NA	NA
8	COM5_CTS#	NA	NA
9	COM5_RI#	NA	NA
10	COM6_DCD#	TXD422#	TXD485#
11	COM6_SIN#	TXD422+	TXD485+
12	COM6_SOUT#	RXD422+	NA
13	COM6_DTR#	RXD422#	NA
14	GND	NA	NA
15	COM6_DSR#	NA	NA
16	COM6_RTS#	NA	NA
17	COM6_CTS#	NA	NA
18	COM6_RI#	NA	NA

**Table 4-23: RS-232 Serial Port Connector Pinouts (COM5-6)**

#### 4.3.11 VGA Connector (VGA1)

PIN NO.	DESCRIPTION	PIN NO.	DESCRIPTION
1	VGA1_BR	2	VGA1_BG
3	VGA1_BB	4	NC
5	GND	6	GND
7	GND	8	GND
9	VGA1_VCC	10	VGA1_PLUG#
11	NC	12	VGA1_DDC_SDA_C
13	VGA1_HSYNC	14	VGA1_VSYNC
15	VGA1_DDC_SCL_C		

**Table 4-24: VGA Connector Pinouts (VGA1)**

## 4.4 Jumper Settings

The buttons, jumper and switch on the system motherboard are listed in **Table 4-25**.

Connector	Type	Label
AT/ATX Mode select switch	switch	AT_SEL1
Clear CMOS button	button	J_CMOS1
M-SATA auto-detect jumper	2-pin header	MIMI_SW1
System reset button	button	RST1

**Table 4-25: Buttons, Jumper and Switch**

### 4.4.1 AT/ATX Mode Select Switch (AT\_SEL1)

Setting	Description
Short A-B	AT Mode (Default)
Short B-C	ATX Mode

**Table 4-26: AT/ATX Mode Select Switch (AT\_SEL1)**

### 4.4.2 Clear CMOS Button (J\_CMOS1)

Setting	Description
Open	Normal Operation (Default)
Push	Clear CMOS Setup

**Table 4-27: Clear CMOS Button (J\_CMOS1)**

### 4.4.3 M-SATA Auto-detect Jumper (MIMI\_SW1)

Setting	Description
Open	Auto detect
Short	Disable M-SATA

**Table 4-28: M-SATA Auto-detect Jumper (MIMI\_SW1 )**

## TANK-610-BW Embedded System

### 4.4.4 System Reset Button (RST1)

Setting	Description
Open	Normal Operation (Default)
Push	System Restart

**Table 4-29: System Reset Button (RST1)**

Chapter

5

**BIOS**

---



## 5.1 Introduction

The BIOS is programmed onto the BIOS chip. The BIOS setup program allows changes to certain system settings. This chapter outlines the options that can be changed.

### 5.1.1 Starting Setup

The UEFI BIOS is activated when the computer is turned on. The setup program can be activated in one of two ways.

1. Press the **DEL** or **F2** key as soon as the system is turned on or
2. Press the **DEL** or **F2** key when the “**Press DEL or F2 to enter SETUP**” message appears on the screen.

If the message disappears before the **DEL** or **F2** key is pressed, restart the computer and try again.

### 5.1.2 Using Setup

Use the arrow keys to highlight items, press **ENTER** to select, use the PageUp and PageDown keys to change entries, press **F1** for help and press **ESC** to quit. Navigation keys are shown in.

Key	Function
Up arrow	Move to previous item
Down arrow	Move to next item
Left arrow	Move to the item on the left hand side
Right arrow	Move to the item on the right hand side
+	Increase the numeric value or make changes
-	Decrease the numeric value or make changes
Page Up key	Increase the numeric value or make changes
Page Dn key	Decrease the numeric value or make changes

Key	Function
Esc key	Main Menu – Quit and not save changes into CMOS Status Page Setup Menu and Option Page Setup Menu -- Exit current page and return to Main Menu
F1	General help, only for Status Page Setup Menu and Option Page Setup Menu
F2	Previous values
F3	Load optimized defaults
F4	Save changes and Exit BIOS

**Table 5-1: BIOS Navigation Keys**

### 5.1.3 Getting Help

When **F1** is pressed a small help window describing the appropriate keys to use and the possible selections for the highlighted item appears. To exit the Help Window press **Esc** or the **F1** key again.

### 5.1.4 Unable to Reboot after Configuration Changes

If the computer cannot boot after changes to the system configuration is made, CMOS defaults. Use the jumper described in Chapter 2.

### 5.1.5 BIOS Menu Bar

The **menu bar** on top of the BIOS screen has the following main items:

- Main – Changes the basic system configuration.
- Advanced – Changes the advanced system settings.
- Chipset – Changes the chipset settings.
- Boot – Changes the system boot configuration.
- Security – Sets User and Supervisor Passwords.
- Save & Exit – Selects exit options and loads default settings.

The following sections completely describe the configuration options found in the menu items at the top of the BIOS screen and listed above.

## TANK-610-BW Embedded System

### 5.2 Main

The **Main** BIOS menu (**BIOS Menu 1**) appears when the **BIOS Setup** program is entered.

The **Main** menu gives an overview of the basic system information.

Aptio Setup Utility - Copyright (C) 2016 American Megatrends, Inc.					
Main	Advanced	Chipset	Boot	Security	Save & Exit
BIOS Information					Set the Date. Use Tab to switch between Data elements.  ----- ←→: Select Screen ↑↓: Select Item Enter>Select +/-: Change Opt. F1: General Help F2: Previous Values F3: Optimized Defaults F4: Save & Exit ESC: Exit
BIOS Vendor			American Megatrends		
Core Version			5.11		
Compliancy			UEFI 2.4; PI 1.3		
Project Version			SEN3AR01.ROM		
Build Date and Time			03/11/2016 09:21:54		
iWDD Vendor			ICP		
iWDD Version			SE64ER10.bin		
CPU Configuration					
Microcode Patch			403		
Memory Information					
Total Memory			2048 MB (LPDDR3)		
TXE Information					
Sec RC Version			00.05.00.00		
TXE FW Version			02.00.02.2092		
System Date			[Fri 04/22/2016]		
System Time			[15:10:27]		
Version 2.17.1249. Copyright (C) 2016 American Megatrends, Inc.					

#### BIOS Menu 1: Main

The Main menu lists the following system details:

- BIOS Information
- iWDD Information
- CPU Information
- Memory Information
- TXE Information

The Main menu has two user configurable fields:

The System Overview field also has two user configurable fields:

→ System Date [xx/xx/xx]

Use the **System Date** option to set the system date. Manually enter the day, month and year.

→ System Time [xx:xx:xx]

Use the **System Time** option to set the system time. Manually enter the hours, minutes and seconds.

### 5.3 Advanced

Use the **Advanced** menu (**BIOS Menu 2**) to configure the CPU and peripheral devices through the following sub-menus:



**WARNING!**

Setting the wrong values in the sections below may cause the system to malfunction. Make sure that the settings made are compatible with the hardware.

```

Aptio Setup Utility - Copyright (C) 2016 American Megatrends, Inc.
Main  Advanced  Chipset  Boot  Security  Save & Exit
-----
> ACPI Settings
> F81866 Super IO Configuration
> Hardware Monitor
> IT8528SEC Super IO Configuration
> RTC Wake Settings
> Serial Port Console Redirection
> iEi Feature
> CPU Configuration
> SATA Configuration
> USB Configuration

System ACPI Parameters
-----
<->: Select Screen
↑ ↓: Select Item
Enter>Select
+/-: Change Opt.
F1: General Help
F2: Previous Values
F3: Optimized Defaults
F4: Save & Exit
ESC: Exit

Version 2.17.1249. Copyright (C) 2016 American Megatrends, Inc.
    
```

**BIOS Menu 2: Advanced**

### 5.3.1 ACPI Settings

The **ACPI Settings** menu (**BIOS Menu 3**) configures the Advanced Configuration and Power Interface (ACPI) options.

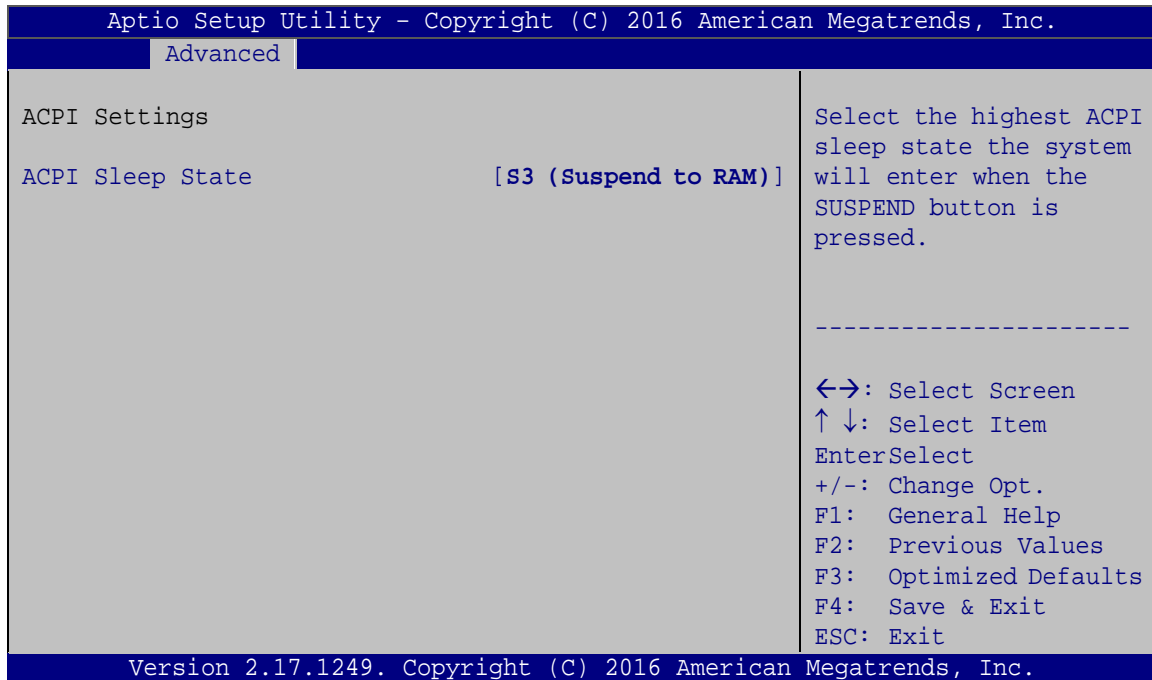

#### BIOS Menu 3: ACPI Configuration

##### → ACPI Sleep State [S1 (CPU Stop Clock)]

Use the **ACPI Sleep State** option to specify the sleep state the system enters when it is not being used.

- **Suspend Disabled** Disable the suspend function.
- **S3 only (Suspend to RAM) DEFAULT** The caches are flushed and the CPU is powered off. Power to the RAM is maintained. The computer returns slower to a working state, but more power is saved.

### 5.3.2 F81866 Super IO Configuration

Use the **F81866 Super IO Configuration** menu (**BIOS Menu 4**) to set or change the configurations for the serial ports.

```

Aptio Setup Utility - Copyright (C) 2016 American Megatrends, Inc.
  Advanced
F81866 Super IO Configuration                               Set Parameters of Serial
                                                           Port 1 (COMA)
F81866 Super IO Chip                                     F81866
> Serial Port 1 Configuration
> Serial Port 2 Configuration
> Serial Port 3 Configuration
> Serial Port 4 Configuration
> Serial Port 5 Configuration
> Serial Port 6 Configuration
-----
<->: Select Screen
↑ ↓: Select Item
EnterSelect
+/-: Change Opt.
F1: General Help
F2: Previous Values
F3: Optimized Defaults
F4: Save & Exit
ESC: Exit
Version 2.17.1249. Copyright (C) 2016 American Megatrends, Inc.
    
```

**BIOS Menu 4: F81866 Super IO Configuration**

#### 5.3.2.1 Serial Port n Configuration

Use the **Serial Port n Configuration** menu (**BIOS Menu 5**) to configure the serial port n.

```

Aptio Setup Utility - Copyright (C) 2016 American Megatrends, Inc.
  Advanced
Serial Port n Configuration                               Enable or Disable Serial
                                                           Port (COM)
Serial Port                                             [Enabled]
Device Settings                                       IO=3F8h; IRQ=4
Change Settings                                       [Auto]
-----
<->: Select Screen
↑ ↓: Select Item
EnterSelect
+/-: Change Opt.
F1: General Help
F2: Previous Values
F3: Optimized Defaults
F4: Save & Exit
ESC: Exit
Version 2.17.1249. Copyright (C) 2016 American Megatrends, Inc.
    
```

**BIOS Menu 5: Serial Port n Configuration Menu**

## TANK-610-BW Embedded System

### 5.3.2.1.1 Serial Port 1 Configuration

#### → Serial Port [Enabled]

Use the **Serial Port** option to enable or disable the serial port.

- **Disabled**                      Disable the serial port
- **Enabled**      **DEFAULT**      Enable the serial port

#### → Change Settings [Auto]

Use the **Change Settings** option to change the serial port IO port address and interrupt address.

- **Auto**                      **DEFAULT**      The serial port IO port address and interrupt address are automatically detected.
- **IO=3F8h; IRQ=4**                      Serial Port I/O port address is 3F8h and the interrupt address is IRQ4
- **IO=3F8h; IRQ=3, 4, 5, 6, 7, 9, 10, 11, 12**                      Serial Port I/O port address is 3F8h and the interrupt address is IRQ3, 4, 5, 6, 7, 9, 10, 11, 12
- **IO=2F8h; IRQ=3, 4, 5, 6, 7, 9, 10, 11, 12**                      Serial Port I/O port address is 2F8h and the interrupt address is IRQ3, 4, 5, 6, 7, 9, 10, 11, 12
- **IO=3E8h; IRQ=3, 4, 5, 6, 7, 9, 10, 11, 12**                      Serial Port I/O port address is 3E8h and the interrupt address is IRQ3, 4, 5, 6, 7, 9, 10, 11, 12
- **IO=2E8h; IRQ=3, 4, 5, 6, 7, 9, 10, 11, 12**                      Serial Port I/O port address is 2E8h and the interrupt address is IRQ3, 4, 5, 6, 7, 9, 10, 11, 12

### 5.3.2.1.2 Serial Port 2 Configuration

➔ Serial Port [Enabled]

Use the **Serial Port** option to enable or disable the serial port.

- ➔ **Disabled**                      Disable the serial port
- ➔ **Enabled      DEFAULT**      Enable the serial port

➔ Change Settings [Auto]

Use the **Change Settings** option to change the serial port IO port address and interrupt address.

- ➔ **Auto                      DEFAULT**      The serial port IO port address and interrupt address are automatically detected.
- ➔ **IO=2F8h; IRQ=3**                      Serial Port I/O port address is 2F8h and the interrupt address is IRQ3
- ➔ **IO=3F8h; IRQ=3, 4, 5, 6, 7, 9, 10, 11, 12**                      Serial Port I/O port address is 3F8h and the interrupt address is IRQ3, 4, 5, 6, 7, 9, 10, 11, 12
- ➔ **IO=2F8h; IRQ=3, 4, 5, 6, 7, 9, 10, 11, 12**                      Serial Port I/O port address is 2F8h and the interrupt address is IRQ3, 4, 5, 6, 7, 9, 10, 11, 12
- ➔ **IO=3E8h; IRQ=3, 4, 5, 6, 7, 9, 10, 11, 12**                      Serial Port I/O port address is 3F8h and the interrupt address is IRQ3, 4, 5, 6, 7, 9, 10, 11, 12
- ➔ **IO=2E8h; IRQ=3, 4, 5, 6, 7, 9, 10, 11, 12**                      Serial Port I/O port address is 2F8h and the interrupt address is IRQ3, 4, 5, 6, 7, 9, 10, 11, 12



## TANK-610-BW Embedded System

### 5.3.2.1.3 Serial Port 3 Configuration

#### ➔ Serial Port [Enabled]

Use the **Serial Port** option to enable or disable the serial port.

- ➔ **Disabled**                      Disable the serial port
- ➔ **Enabled      DEFAULT**      Enable the serial port

#### ➔ Change Settings [Auto]

Use the **Change Settings** option to change the serial port IO port address and interrupt address.

- ➔ **Auto                      DEFAULT**      The serial port IO port address and interrupt address are automatically detected.
- ➔ **IO=3E8h; IRQ=7**                      Serial Port I/O port address is 3E8h and the interrupt address is IRQ7
- ➔ **IO=3E8h; IRQ=3, 4, 5, 6, 7, 9, 10, 11, 12**                      Serial Port I/O port address is 3E8h and the interrupt address is IRQ3, 4, 5, 6, 7, 9, 10, 11, 12
- ➔ **IO=2E8h; IRQ=3, 4, 5, 6, 7, 9, 10, 11, 12**                      Serial Port I/O port address is 2E8h and the interrupt address is IRQ3, 4, 5, 6, 7, 9, 10, 11, 12
- ➔ **IO=2F0h; IRQ=3, 4, 5, 6, 7, 9, 10, 11, 12**                      Serial Port I/O port address is 2F0h and the interrupt address is IRQ3, 4, 5, 6, 7, 9, 10, 11, 12
- ➔ **IO=2E0h; IRQ=3, 4, 5, 6, 7, 9, 10, 11, 12**                      Serial Port I/O port address is 2E0h and the interrupt address is IRQ3, 4, 5, 6, 7, 9, 10, 11, 12

### 5.3.2.1.4 Serial Port 4 Configuration

➔ Serial Port [Enabled]

Use the **Serial Port** option to enable or disable the serial port.

- ➔ **Disabled**                      Disable the serial port
- ➔ **Enabled      DEFAULT**      Enable the serial port

➔ Change Settings [Auto]

Use the **Change Settings** option to change the serial port IO port address and interrupt address.

- ➔ **Auto                      DEFAULT**      The serial port IO port address and interrupt address are automatically detected.
- ➔ **IO=2E8h; IRQ=7**                      Serial Port I/O port address is 2E8h and the interrupt address is IRQ7
- ➔ **IO=3E8h; IRQ=3, 4, 5, 6, 7, 9, 10, 11, 12**                      Serial Port I/O port address is 3E8h and the interrupt address is IRQ3, 4, 5, 6, 7, 9, 10, 11, 12
- ➔ **IO=2E8h; IRQ=3, 4, 5, 6, 7, 9, 10, 11, 12**                      Serial Port I/O port address is 2E8h and the interrupt address is IRQ3, 4, 5, 6, 7, 9, 10, 11, 12
- ➔ **IO=2F0h; IRQ=3, 4, 5, 6, 7, 9, 10, 11, 12**                      Serial Port I/O port address is 2F0h and the interrupt address is IRQ3, 4, 5, 6, 7, 9, 10, 11, 12
- ➔ **IO=2E0h; IRQ=3, 4, 5, 6, 7, 9, 10, 11, 12**                      Serial Port I/O port address is 2E0h and the interrupt address is IRQ3, 4, 5, 6, 7, 9, 10, 11, 12

## TANK-610-BW Embedded System

### 5.3.2.1.5 Serial Port 5 Configuration

#### → Serial Port [Enabled]

Use the **Serial Port** option to enable or disable the serial port.

- **Disabled**                                      Disable the serial port
- **Enabled      DEFAULT**                      Enable the serial port

#### → Change Settings [Auto]

Use the **Change Settings** option to change the serial port IO port address and interrupt address.

- **Auto                                      DEFAULT**                      The serial port IO port address and interrupt address are automatically detected.
- **IO=2E0h; IRQ=7**                                      Serial Port I/O port address is 2E0h and the interrupt address is IRQ7
- **IO=3E8h; IRQ=3, 4, 5, 6, 7, 9, 10, 11, 12**                                      Serial Port I/O port address is 3E8h and the interrupt address is IRQ3, 4, 5, 6, 7, 9, 10, 11, 12
- **IO=2E8h; IRQ=3, 4, 5, 6, 7, 9, 10, 11, 12**                                      Serial Port I/O port address is 2E8h and the interrupt address is IRQ3, 4, 5, 6, 7, 9, 10, 11, 12
- **IO=2F0h; IRQ=3, 4, 5, 6, 7, 9, 10, 11, 12**                                      Serial Port I/O port address is 2F0h and the interrupt address is IRQ3, 4, 5, 6, 7, 9, 10, 11, 12
- **IO=2E0h; IRQ=3, 4, 5, 6, 7, 9, 10, 11, 12**                                      Serial Port I/O port address is 2E0h and the interrupt address is IRQ3, 4, 5, 6, 7, 9, 10, 11, 12

#### → Device Mode [RS232]

Use the **Device Mode** option to select the serial port mode.

- ➔ **RS232**                      **DEFAULT**      Enables serial port RS-232 support.
- ➔ **RS422**    Enables serial port RS-422 support.
- ➔ **RS485**    Enables serial port RS-485 support.

### 5.3.2.1.6 Serial Port 6 Configuration

#### ➔ Serial Port [Enabled]

Use the **Serial Port** option to enable or disable the serial port.

- ➔ **Disabled**                                      Disable the serial port
- ➔ **Enabled**                      **DEFAULT**      Enable the serial port

#### ➔ Change Settings [Auto]

Use the **Change Settings** option to change the serial port IO port address and interrupt address.

- ➔ **Auto**                                      **DEFAULT**      The serial port IO port address and interrupt address are automatically detected.
- ➔ **IO=2F0h; IRQ=7**                                      Serial Port I/O port address is 2F0h and the interrupt address is IRQ7
- ➔ **IO=3E8h; IRQ=3, 4, 5, 6, 7, 9, 10, 11, 12**                                      Serial Port I/O port address is 3E8h and the interrupt address is IRQ3, 4, 5, 6, 7, 9, 10, 11, 12
- ➔ **IO=2E8h; IRQ=3, 4, 5, 6, 7, 9, 10, 11, 12**                                      Serial Port I/O port address is 2E8h and the interrupt address is IRQ3, 4, 5, 6, 7, 9, 10, 11, 12
- ➔ **IO=2F0h; IRQ=3, 4, 5, 6, 7, 9, 10, 11, 12**                                      Serial Port I/O port address is 2F0h and the interrupt address is IRQ3, 4, 5, 6, 7, 9, 10, 11, 12

## TANK-610-BW Embedded System

➔ IO=2E0h; IRQ=3, 4,  
5, 6, 7, 9, 10, 11, 12

Serial Port I/O port address is 2E0h and the interrupt address is IRQ3, 4, 5, 6, 7, 9, 10, 11, 12

➔ Device Mode [RS232]

Use the **Device Mode** option to select the serial port mode.

- ➔ **RS232**                    **DEFAULT**    Enables serial port RS-232 support.
- ➔ **RS422**                    Enables serial port RS-422 support.
- ➔ **RS485**                    Enables serial port RS-485 support.

### 5.3.3 H/W Monitor

The **H/W Monitor** menu (**BIOS Menu 6**) shows the operating temperature, fan speeds and system voltages.

```

Aptio Setup Utility - Copyright (C) 2016 American Megatrends, Inc.
-----
Advanced
-----
PC Health Status
CPU Temperature           :+34 C
System Temperature       :+35 C
-----
<=>: Select Screen
↑ ↓: Select Item
Enter>Select
+/-: Change Opt.
F1:  General Help
F2:  Previous Values
F3:  Optimized
Defaults
F4:  Save & Exit
ESC: Exit
-----
Version 2.17.1249. Copyright (C) 2016 American Megatrends, Inc.

```

#### BIOS Menu 6: Hardware Health Configuration

➔ PC Health Status

The following system parameters and values are shown. The system parameters that are monitored are:

- System Temperatures:
  - CPU Temperature
  - System Temperature

### 5.3.4 IT8528SEC Super IO Configuration

Use the **IT8528SEC Super IO Configuration** menu (**BIOS Menu 7**) to set or change the configurations for the serial ports.

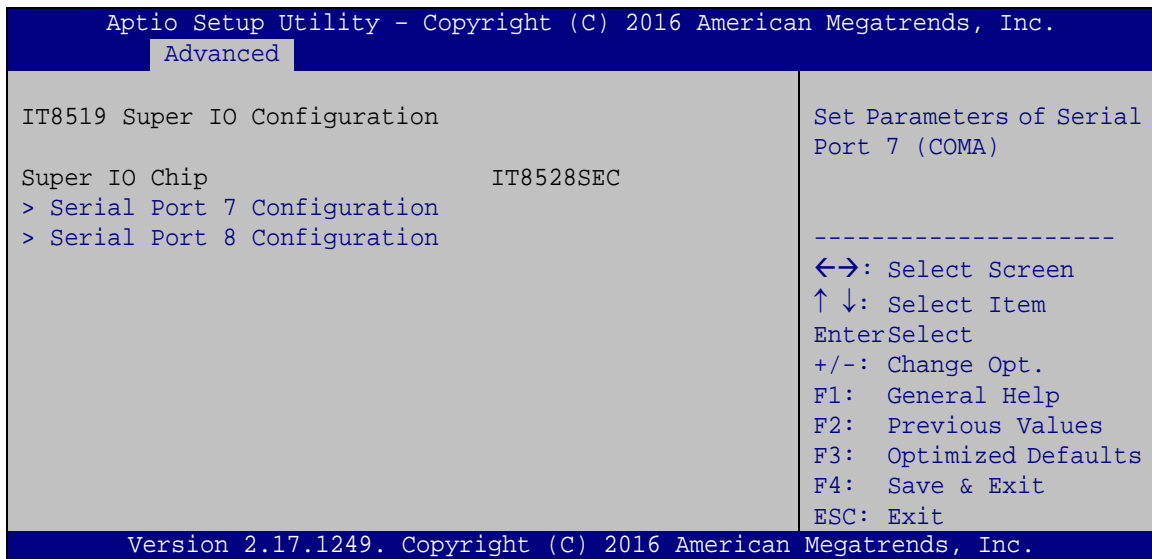

#### **BIOS Menu 7: Secondary Super IO Configuration**

## TANK-610-BW Embedded System

### 5.3.4.1 Serial Port n Configuration

Use the **Serial Port n Configuration** menu (**BIOS Menu 8**) to configure the serial port n.

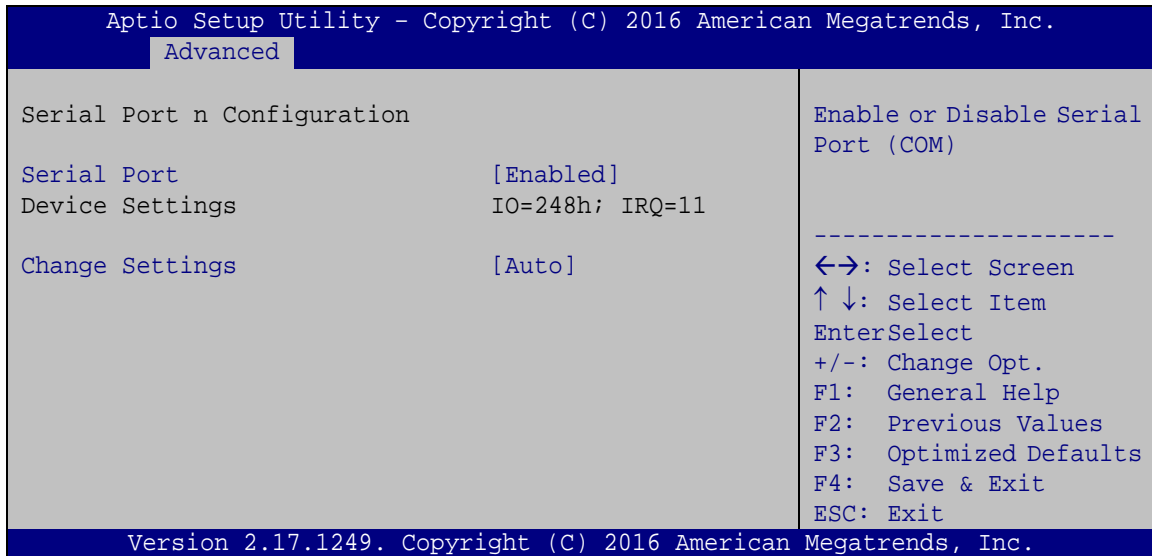

#### BIOS Menu 8: Serial Port n Configuration Menu

##### 5.3.4.1.1 Serial Port 7 Configuration

###### → Serial Port [Enabled]

Use the **Serial Port** option to enable or disable the serial port.

→ **Disabled** Disable the serial port

→ **Enabled** **DEFAULT** Enable the serial port

###### → Change Settings [Auto]

Use the **Change Settings** option to change the serial port IO port address and interrupt address.

→ **Auto** **DEFAULT** The serial port IO port address and interrupt address are automatically detected.

- ➔ **IO=248h; IRQ=7**  
Serial Port I/O port address is 248h and the interrupt address is IRQ7
- ➔ **IO=248h; IRQ=3, 4, 5, 6, 7, 9, 10, 11, 12**  
Serial Port I/O port address is 248h and the interrupt address is IRQ3, 4, 5, 6, 7, 9, 10, 11, 12
- ➔ **IO=258h; IRQ=3, 4, 5, 6, 7, 9, 10, 11, 12**  
Serial Port I/O port address is 258h and the interrupt address is IRQ3, 4, 5, 6, 7, 9, 10, 11, 12
- ➔ **IO=268h; IRQ=3, 4, 5, 6, 7, 9, 10, 11, 12**  
Serial Port I/O port address is 268h and the interrupt address is IRQ3, 4, 5, 6, 7, 9, 10, 11, 12
- ➔ **IO=278h; IRQ=3, 4, 5, 6, 7, 9, 10, 11, 12**  
Serial Port I/O port address is 278h and the interrupt address is IRQ3, 4, 5, 6, 7, 9, 10, 11, 12

#### 5.3.4.1.2 Serial Port 8 Configuration

##### ➔ Serial Port [Enabled]

Use the **Serial Port** option to enable or disable the serial port.

- ➔ **Disabled**                      Disable the serial port
- ➔ **Enabled**            **DEFAULT**            Enable the serial port

##### ➔ Change Settings [Auto]

Use the **Change Settings** option to change the serial port IO port address and interrupt address.

- ➔ **Auto**                      **DEFAULT**            The serial port IO port address and interrupt address are automatically detected.



## TANK-610-BW Embedded System

- ➔ IO=258h; IRQ=7  
Serial Port I/O port address is 258h and the interrupt address is IRQ7
- ➔ IO=248h; IRQ=3, 4, 5, 6, 7, 9, 10, 11, 12  
Serial Port I/O port address is 248h and the interrupt address is IRQ3, 4, 5, 6, 7, 9, 10, 11, 12
- ➔ IO=258h; IRQ=3, 4, 5, 6, 7, 9, 10, 11, 12  
Serial Port I/O port address is 258h and the interrupt address is IRQ3, 4, 5, 6, 7, 9, 10, 11, 12
- ➔ IO=268h; IRQ=3, 4, 5, 6, 7, 9, 10, 11, 12  
Serial Port I/O port address is 268h and the interrupt address is IRQ3, 4, 5, 6, 7, 9, 10, 11, 12
- ➔ IO=278h; IRQ=3, 4, 5, 6, 7, 9, 10, 11, 12  
Serial Port I/O port address is 278h and the interrupt address is IRQ3, 4, 5, 6, 7, 9, 10, 11, 12

## 5.3.5 RTC Wake Settings

The **RTC Wake Settings** menu (**BIOS Menu 9**) configures RTC wake event.

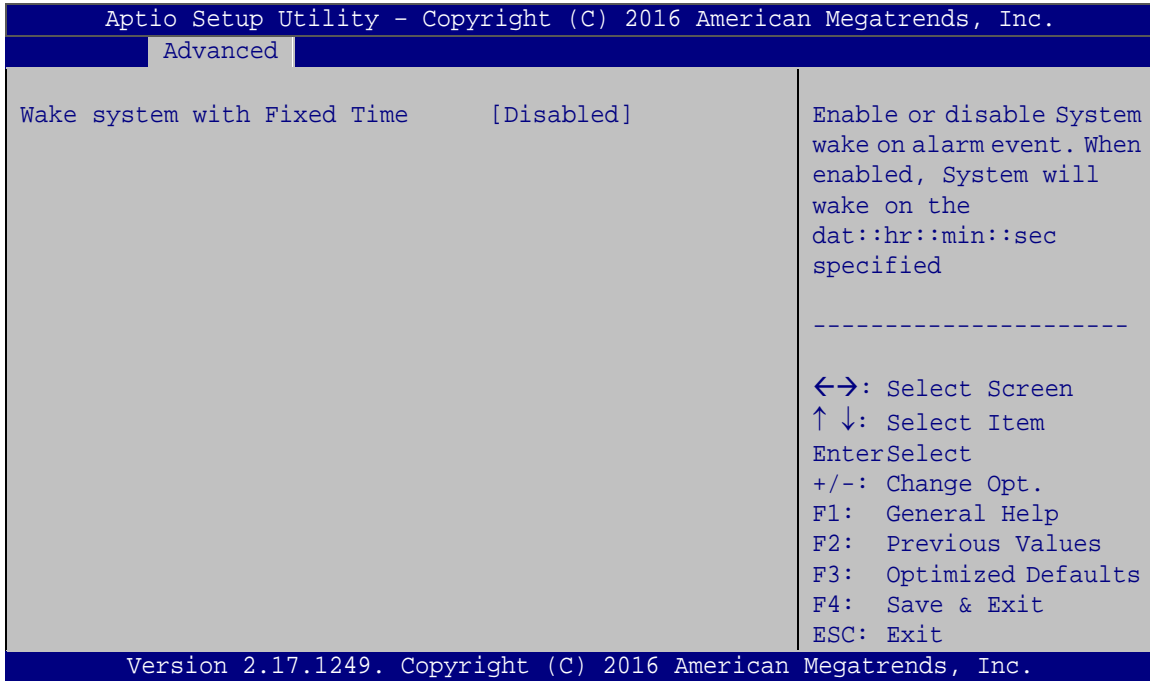

**BIOS Menu 9: RTC Wake Settings**

➔ Wake System with Fixed Time [Disabled]

Use the **Wake System with Fixed Time** option to specify the time the system should be roused from a suspended state.

➔ **Disabled**      **DEFAULT**      The real time clock (RTC) cannot generate a wake event

➔ **Enabled**      If selected, the following appears with values that can be selected:

\*Wake up every day

\*Wake up date

\*Wake up hour

\*Wake up minute

\*Wake up second

After setting the alarm, the computer turns itself on from a suspend state when the alarm goes off.

## TANK-610-BW Embedded System

### 5.3.6 Serial Port Console Redirection

The **Serial Port Console Redirection** menu (**BIOS Menu 10**) allows the console redirection options to be configured. Console redirection allows users to maintain a system remotely by re-directing keyboard input and text output through the serial port.

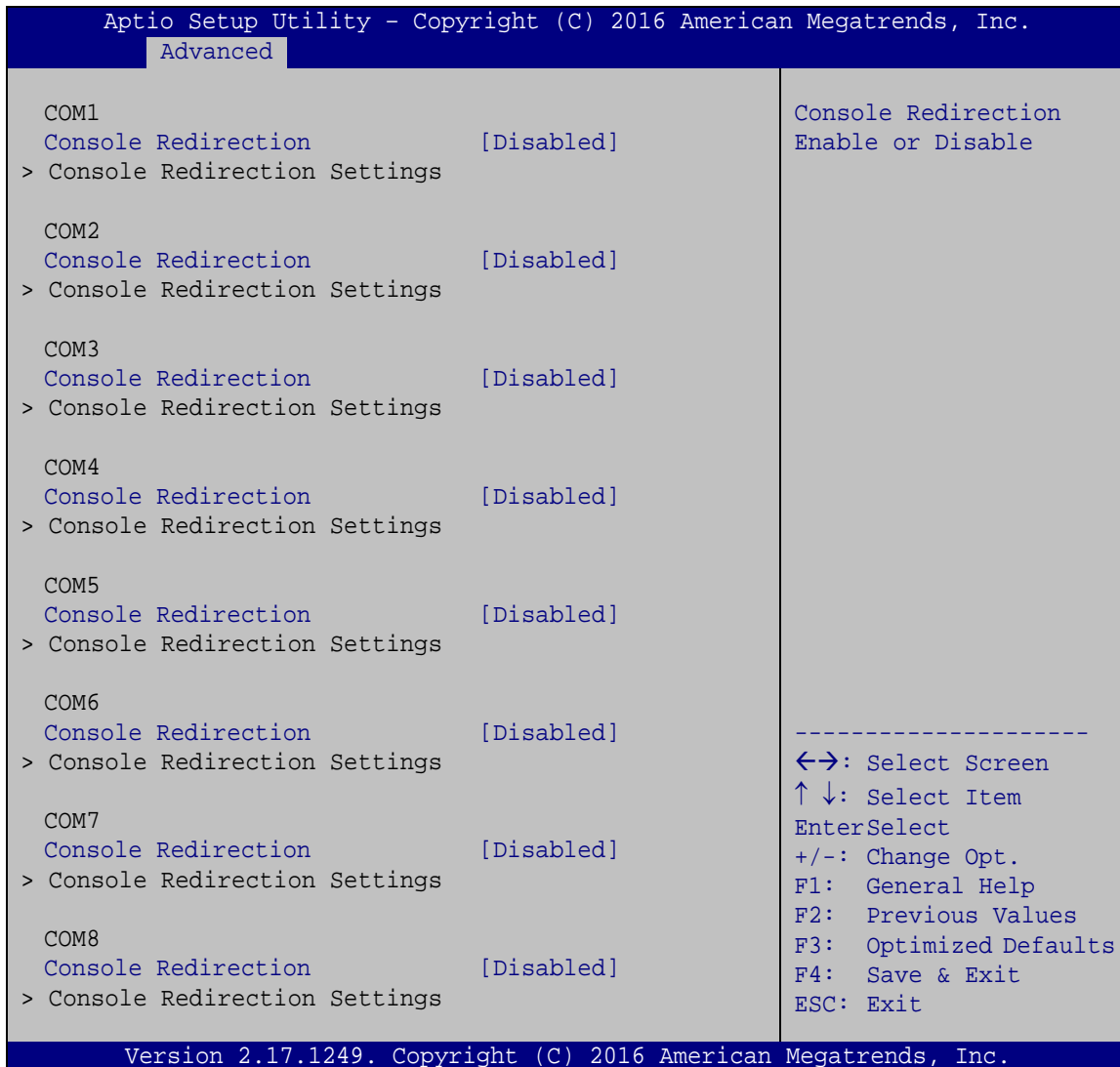

#### BIOS Menu 10: Serial Port Console Redirection

➔ Console Redirection [Disabled]

Use **Console Redirection** option to enable or disable the console redirection function.

➔ **Disabled**    **DEFAULT**    Disabled the console redirection function

- ➔ **Enabled** Enabled the console redirection function

### 5.3.6.1 Console Redirection Settings

The **Console Redirection Settings** menu (**BIOS Menu 11**) allows the console redirection options to be configured. The option is active when Console Redirection option is enabled.

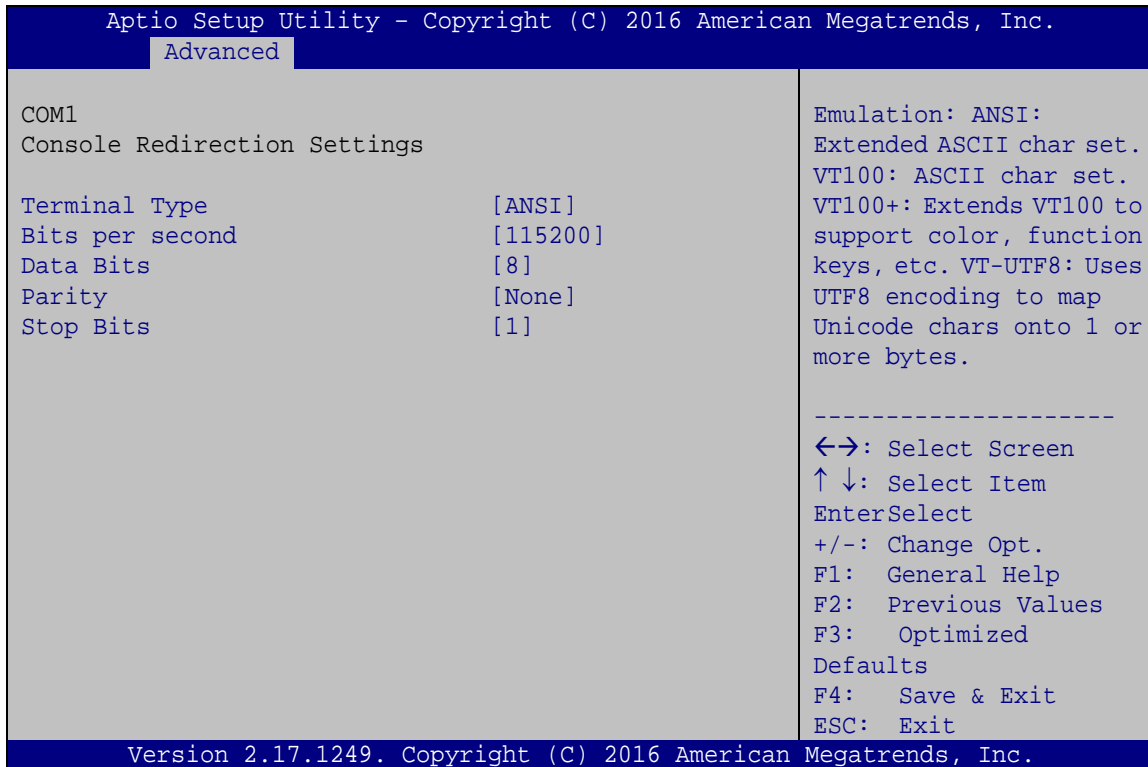

#### BIOS Menu 11: Console Redirection Settings

- ➔ Terminal Type [ANSI]

Use the **Terminal Type** option to specify the remote terminal type..

- ➔ **VT100** The target terminal type is VT100
- ➔ **VT100+** The target terminal type is VT100+
- ➔ **VT-UTF8** The target terminal type is VT-UTF8
- ➔ **ANSI** **DEFAULT** The target terminal type is ANSI

## TANK-610-BW Embedded System

## → Bits per second [115200]

Use the **Bits per second** option to specify the transmission speed of the serial port.

- |   |               |                |                                  |
|---|---------------|----------------|----------------------------------|
| → | <b>9600</b>   |                | The transmission speed is 9600   |
| → | <b>19200</b>  |                | The transmission speed is 19200  |
| → | <b>38400</b>  |                | The transmission speed is 38400  |
| → | <b>57600</b>  |                | The transmission speed is 57600  |
| → | <b>115200</b> | <b>DEFAULT</b> | The transmission speed is 115200 |

## → Data Bits [8]

Use the **Data Bits** option to specify the number of data bits.

- |   |          |                |                          |
|---|----------|----------------|--------------------------|
| → | <b>7</b> |                | Sets the data bits at 7. |
| → | <b>8</b> | <b>DEFAULT</b> | Sets the data bits at 8. |

## → Parity [None]

Use the **Parity** option to specify the parity bit that can be sent with the data bits for detecting the transmission errors.

- |   |              |                |   |
|---|--------------|----------------|---|
| → | <b>None</b>  | <b>DEFAULT</b> | No parity bit is sent with the data bits.                                 |
| → | <b>Even</b>  |                | The parity bit is 0 if the number of ones in the data bits is even.       |
| → | <b>Odd</b>   |                | The parity bit is 0 if the number of ones in the data bits is odd.        |
| → | <b>Mark</b>  |                | The parity bit is always 1. This option does not provide error detection. |
| → | <b>Space</b> |                | The parity bit is always 0. This option does not provide error detection. |

➔ Stop Bits [1]

Use the **Stop Bits** option to specify the number of stop bits used to indicate the end of a serial data packet. Communication with slow devices may require more than 1 stop bit.

- ➔ 1            **DEFAULT**      Sets the number of stop bits at 1.
- ➔ 2                              Sets the number of stop bits at 2.

### 5.3.7 iEi Feature

Use the **iEi Feature** menu (错误! 未找到引用源。) to configure the iEi features.

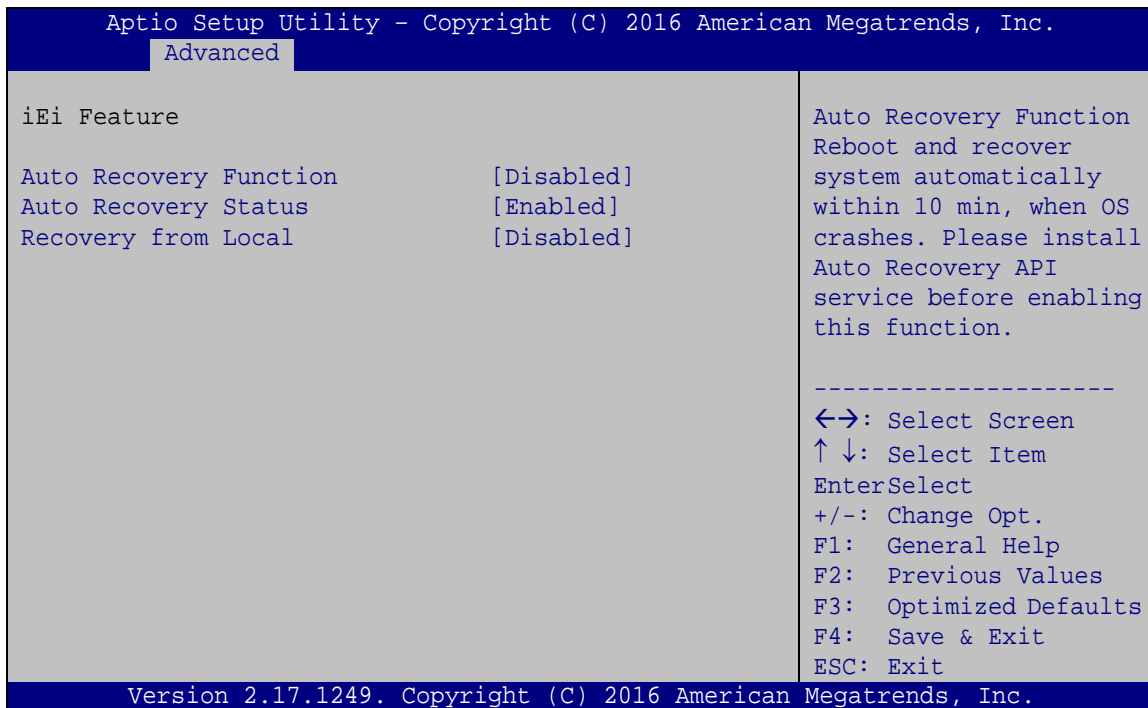

#### BIOS Menu 12: iEi Feature

➔ Auto Recovery Function [Disabled]

Use **Auto Recovery Function** option to enable or disable the auto recovery function.

- ➔ **Disabled**    **DEFAULT**      Disabled the auto recovery function
- ➔ **Enabled**                      Enabled the auto recovery function

## TANK-610-BW Embedded System

### ➔ Auto Recovery Status [Enabled]

Use **Auto Recovery Status** option to enable or disable the auto recovery status.

- ➔ **Disabled**      **DEFAULT**      Disabled the auto recovery status.
- ➔ **Enabled**                      Enabled the auto recovery status.

### ➔ Recovery from Local [Disabled]

Use **Recovery from Local** option to enable or disable recovery from local function..

- ➔ **Disabled**      **DEFAULT**      Disabled the recovery from local function..
- ➔ **Enabled**                      Enabled the recovery from local function..

## 5.3.8 CPU Configuration

Use the **CPU Configuration** menu (**BIOS Menu 13**) to enter the **CPU Information** submenu or enable Intel Virtualization Technology.

```

Aptio Setup Utility - Copyright (C) 2016 American Megatrends, Inc.
  Advanced
CPU Configuration
Intel(R) Celeron(R) CPU N3160 @ 1.60GHz
CPU Signature                406c4
Microcode Patch              403
Max CPU Speed                1600 MHz
Min CPU Speed                480 MHz
Processor Cores              4
Intel HT Technology          Not Supported
Intel VT-X Technology        Supported

L1 Data Cache                24 KB x 4
L1 Code Cache                32 KB x 4
L2 Cache                     1024 KB x 2
L3 Cache                     Not Present
64-bit                       Supported

Intel Virtualization Technology [Disabled]

When enabled, a VMM can utilize the additional hardware capabilities provided by Vanderpool Technology.

-----
<->: Select Screen
↑ ↓: Select Item
Enter>Select
+/-: Change Opt.
F1: General Help
F2: Previous Values
F3: Optimized Defaults
F4: Save & Exit
ESC: Exit

Version 2.17.1249. Copyright (C) 2016 American Megatrends, Inc.
  
```

### BIOS Menu 13: CPU Configuration

The CPU Configuration menu (**BIOS Menu 13**) lists the following CPU details:

- Processor Type: Lists the brand name of the CPU being used
- CPU Signature: Lists the CPU signature value.
- Microcode Patch: Lists the microcode patch being used.
- Max CPU Speed: Lists the maximum CPU processing speed.
- Min CPU Speed: Lists the minimum CPU processing speed.
- Processor Core: Lists the number of the processor cores
- Intel HT Technology: Indicates if Intel HT Technology is supported by the CPU.
- Intel VT-x Technology: Indicates if Intel VT-x Technology is supported by the CPU.
- L1 Data Cache: Lists the amount of data storage space on the L1 cache.
- L1 Code Cache: Lists the amount of code storage space on the L1 cache.
- L2 Cache: Lists the amount of storage space on the L2 cache.
- L3 Cache: Lists the amount of storage space on the L3 cache.
- 64-bit: Indicates if 64-bit is supported by the CPU.

→ Intel Virtualization Technology [Disabled]

Use the **Intel Virtualization Technology** option to enable or disable virtualization on the system. When combined with third party software, Intel Virtualization technology allows several OSs to run on the same system at the same time.

- **Disabled**      **DEFAULT**    Disables Intel Virtualization Technology.
- **Enabled**      Enables Intel Virtualization Technology.



## TANK-610-BW Embedded System

### 5.3.9 SATA Configuration

Use the **SATA Configuration** menu (**BIOS Menu 14**) to change and/or set the configuration of the SATA devices installed in the system.

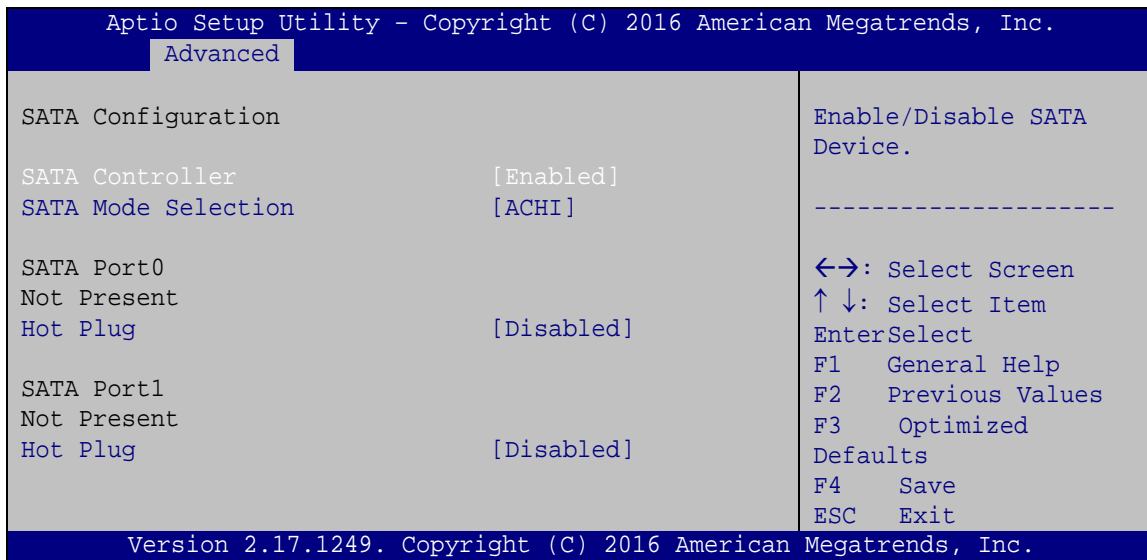

#### BIOS Menu 14: IDE Configuration

##### → SATA Controller [Enabled]

Use the **SATA Controller** option to enable or disable the SATA device.

→ **Disabled** Disables the SATA device.

→ **Enabled** **DEFAULT** Enables the SATA device.

##### → SATA Mode Selection [ACHI]

Use the **SATA Mode Selection** option to configure SATA devices as normal IDE devices.

→ **AHCI** **DEFAULT** Configures SATA devices as AHCI device.

##### → Hot Plug [Disabled]

Use the **Hot Plug** option to configure the port as Hot Pluggable.

→ **Disabled** **DEFAULT** Disables the port as Hot Pluggable.

- ➔ **Enabled** Enables the port as Hot Pluggable.

### 5.3.10 USB Configuration

Use the **USB Configuration** menu (**BIOS Menu 15**) to read USB configuration information and configure the USB settings.

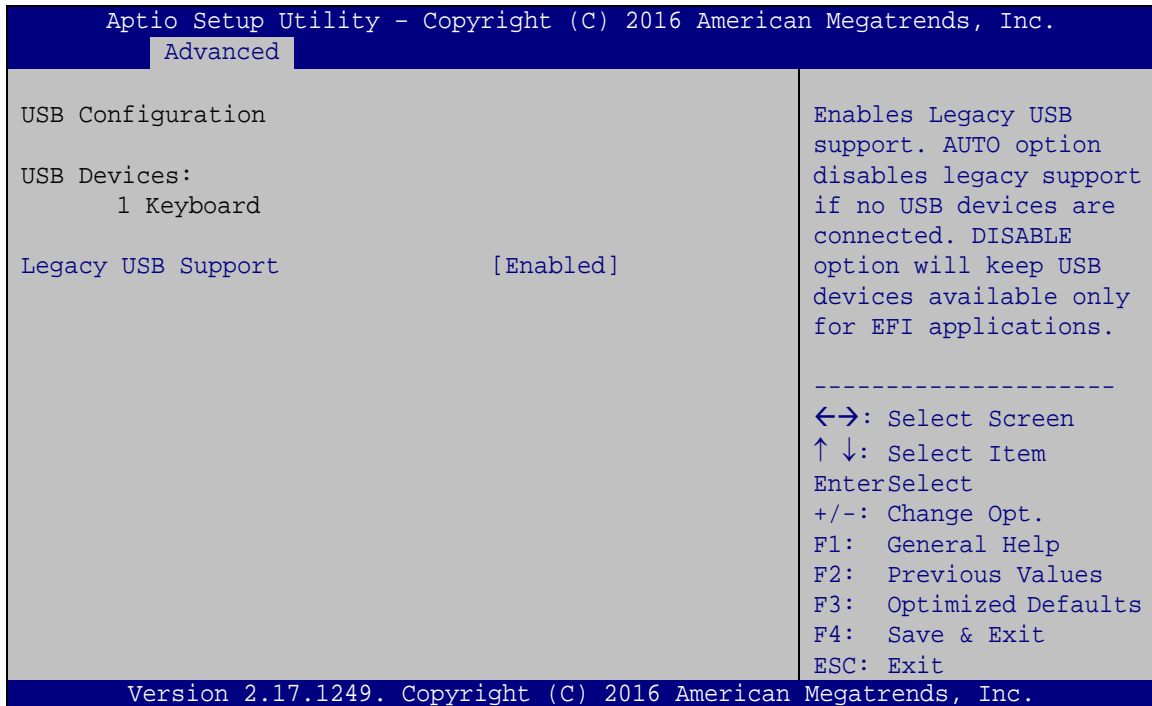

#### BIOS Menu 15: USB Configuration

- ➔ **USB Devices**

The **USB Devices** field lists the USB devices that are enabled on the system

- ➔ **Legacy USB Support [Enabled]**

Use the **Legacy USB Support** BIOS option to enable USB mouse and USB keyboard support. Normally if this option is not enabled, any attached USB mouse or USB keyboard does not become available until a USB compatible operating system is fully booted with all USB drivers loaded. When this option is enabled, any attached USB mouse or USB keyboard can control the system even when there is no USB driver loaded onto the system.

## TANK-610-BW Embedded System

- ➔ **Enabled**      **DEFAULT**      Legacy USB support enabled
- ➔ **Disabled**                      Legacy USB support disabled
- ➔ **Auto**                      Legacy USB support disabled if no USB devices are connected

### 5.4 Chipset

Use the **Chipset** menu (**BIOS Menu 16**) to access the Host Bridge and South Bridge configuration menus.



#### WARNING!

Setting the wrong values for the Chipset BIOS selections in the Chipset BIOS menu may cause the system to malfunction.

```

Aptio Setup Utility - Copyright (C) 2016 American Megatrends, Inc.
Main   Advanced  Chipset  Boot   Security  Save & Exit
-----
> North Bridge
> South Bridge

Host Bridge Parameters
-----
<=>: Select Screen
↑ ↓: Select Item
Enter>Select
+/-: Change Opt.
F1:  General Help
F2:  Previous Values
F3:  Optimized Defaults
F4:  Save & Exit
ESC: Exit

Version 2.17.1249. Copyright (C) 2016 American Megatrends, Inc.
    
```

**BIOS Menu 16: Chipset**

### 5.4.1 North Bridge Configuration

Use the **North Bridge** menu (**BIOS Menu 17**) to configure the north bridge chipset..

```

Aptio Setup Utility - Copyright (C) 2016 American Megatrends, Inc.
  Chipset
> Intel IGD Configuration
Memory Information
Total Memory                2048 MB (LPDDR3)
Memory Slot0                2048 MB (LPDDR3)
Memory Slot2                Not Present
Config Intel IGD Settings.
-----
<->: Select Screen
↑ ↓: Select Item
EnterSelect
F1  General Help
F2  Previous Values
F3  Optimized
Defaults
F4  Save
ESC Exit
Version 2.17.1249. Copyright (C) 2016 American Megatrends, Inc.
  
```

#### BIOS Menu 17: Host Bridge

#### 5.4.1.1 Intel IGD Configuration

Use the **Intel IGD Configuration** menu to configure the video device connected to the system.

```

Aptio Setup Utility - Copyright (C) 2016 American Megatrends, Inc.
  Chipset
Intel IGD Configuration
Primary Display              [Auto]
Primary IGFX Boot Display   [Auto]
DVMT Pre-Allocated          [32M]
DVMT Total Gfx Mem          [256M]
Select which of IGD/PCI Graphics device should be Primary Display.
-----
<->: Select Screen
↑ ↓: Select Item
EnterSelect
F1  General Help
F2  Previous Values
F3  Optimized
Defaults
F4  Save
ESC Exit
Version 2.17.1249. Copyright (C) 2016 American Megatrends, Inc.
  
```

#### BIOS Menu 18: Graphics Configuration

## TANK-610-BW Embedded System

## → Primary Display [Auto]

Use the **Primary Display** option to select the primary graphics controller the system uses.

The following options are available:

- Auto                   **Default**
- IGD
- PCIe

## → Primary IGFX Boot Display [Auto]

Use the **Primary IGFX Boot Display** option to select the display device used by the system when it boots. Configuration options are listed below.

- Auto                   **DEFAULT**
- HDMI
- CRT

## → DVMT Pre-Allocated [32MB]

Use the **DVMT Pre-Allocated** option to set the amount of system memory allocated to the integrated graphics processor when the system boots. The system memory allocated can then only be used as graphics memory, and is no longer available to applications or the operating system. Configuration options are listed below:

- 32M                   **Default**
- 64M
- 96M
- 128M
- 160M
- 192M
- 224M
- 256M
- 288M
- 320M
- 352M
- 384M
- 416M

- 448M
- 480M
- 512M

➔ DVMT Total Gfx Mem [256M]

Use the **DVMT Total Gfx Mem** option to select DVMT5.0 total graphic memory size used by the internal graphic device. The following options are available:

- 128M
- 256M                   **Default**
- MAX

### 5.4.2 South Bridge Configuration

Use the **South Bridge** menu (**BIOS Menu 19**) to configure the south bridge chipset.

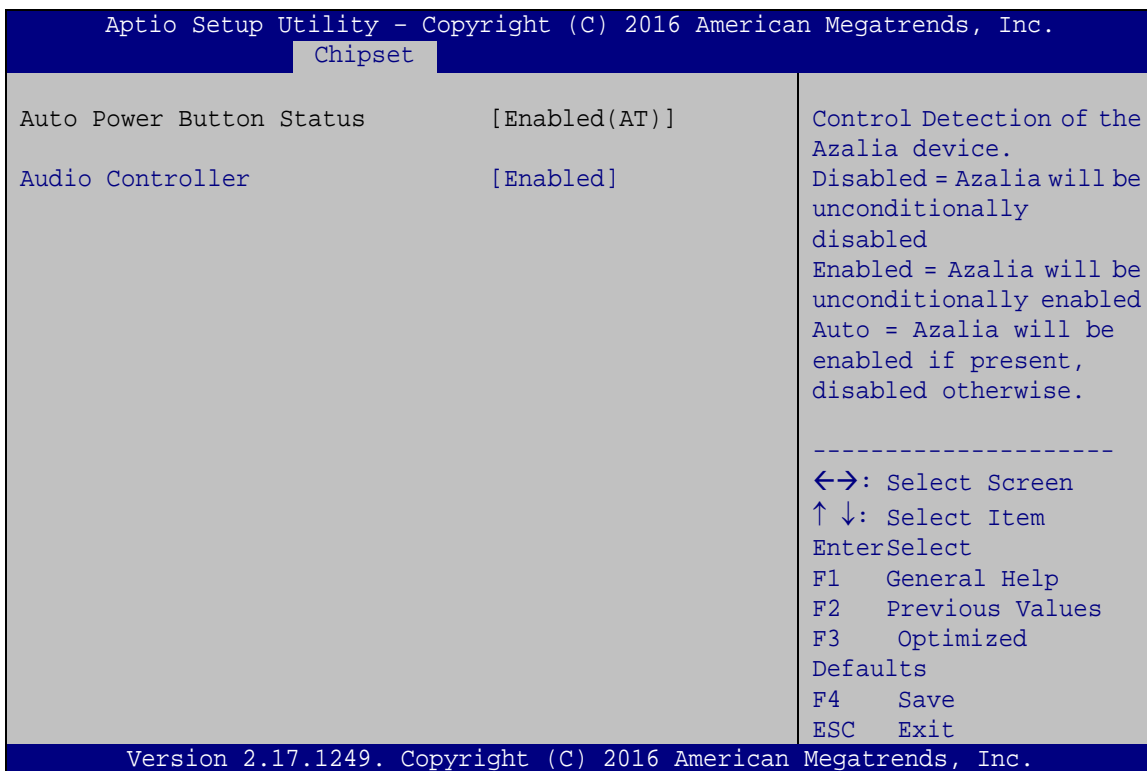

**BIOS Menu 19:South Bridge**

## TANK-610-BW Embedded System

### → Audio Controller [Enabled]

Use the **Audio Controller** option to enable or disable the High Definition Audio controller.

- **Disabled**                      The onboard High Definition Audio controller is disabled
- **Enabled    DEFAULT**        The onboard High Definition Audio controller automatically detected and enabled

## 5.5 Security

Use the **Security** menu (**BIOS Menu 20**) to set system and user passwords.

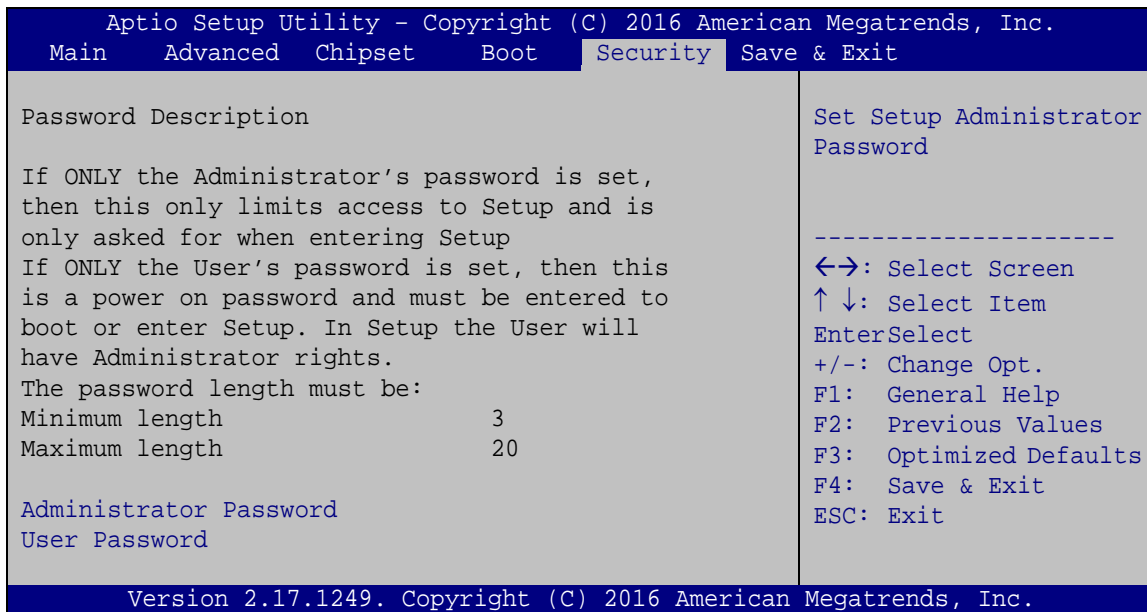

### BIOS Menu 20: Security

#### → Administrator Password

Use the **Administrator Password** to set or change an administrator password.

#### → User Password

Use the **User Password** to set or change a user password.

## 5.6 Boot

Use the **Boot** menu (**BIOS Menu 21**) to configure system boot options.

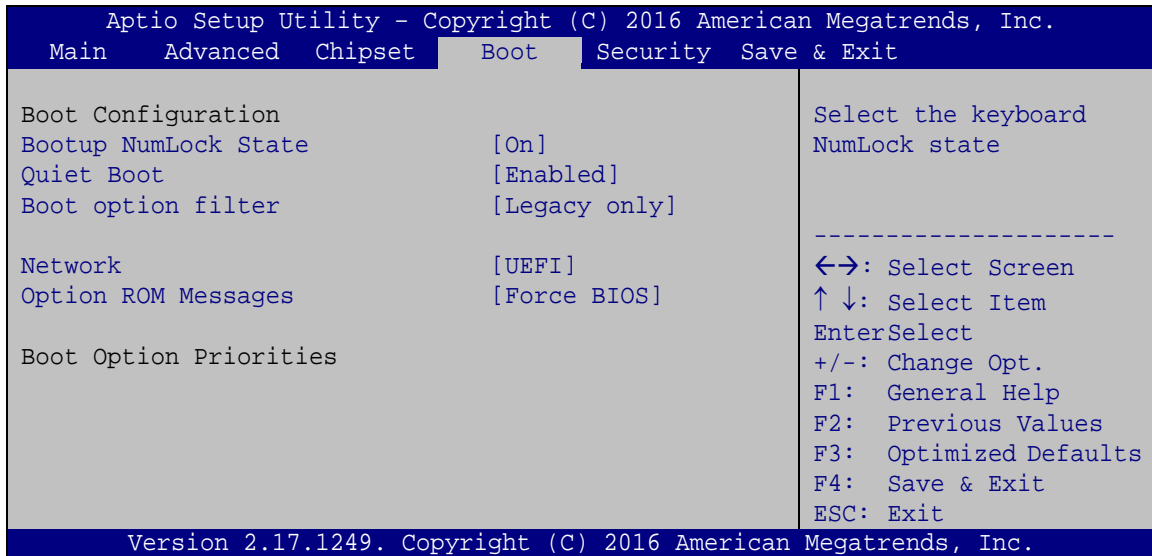

### BIOS Menu 21: Boot

#### → Bootup NumLock State [On]

Use the **Bootup NumLock State** BIOS option to specify if the number lock setting must be modified during boot up.

→ **On**                      **DEFAULT**                      Allows the Number Lock on the keyboard to be enabled automatically when the computer system boots up. This allows the immediate use of the 10-key numeric keypad located on the right side of the keyboard. To confirm this, the Number Lock LED light on the keyboard is lit.

→ **Off**                                      Does not enable the keyboard Number Lock automatically. To use the 10-keys on the keyboard, press the Number Lock key located on the upper left-hand corner of the 10-key pad. The Number Lock LED on the keyboard lights up when the Number Lock is engaged.



## TANK-610-BW Embedded System

## → Quiet Boot [Enabled]

Use the **Quiet Boot** BIOS option to select the screen display when the system boots.

- **Disabled** Normal POST messages displayed
- **Enabled** **DEFAULT** OEM Logo displayed instead of POST messages

## → Boot Option filter [Legacy only]

Use the **Boot Option filter** option to control legacy/UEFI ROMs priority.

- **UEFI and Legacy** Sets ROMs priority to UEFI and legacy
- **Legacy only** **DEFAULT** Sets ROMs priority to legacy only
- **UEFI only** Sets ROMs priority to UEFI only

## → Network [UEFI]

Use the **Network** option to controls the execution of UEFI and Legacy PXE OpROM.

- **Do not launch** Ignore UEFI and Legacy PXE OpROM.
- **UEFI** **DEFAULT** Boot from UEFI devices.
- **Legacy** Boot from legacy devices.

## → Option ROM Messages [Force BIOS]

Use the **Option ROM Messages** option to set the Option ROM display mode.

- **Force BIOS** **DEFAULT** Sets display mode to force BIOS.
- **Keep Current** Sets display mode to current.

## 5.7 Exit

Use the **Exit** menu (**BIOS Menu 22**) to load default BIOS values, optimal failsafe values and to save configuration changes.

```
Aptio Setup Utility - Copyright (C) 2016 American Megatrends, Inc.
Main   Advanced  Chipset   Boot     Security  Save & Exit
-----
Save Changes and Reset
Discard Changes and Reset

Restore Defaults
Save as User Defaults
Restore User Defaults

Exit the system after
saving the changes.

-----
<->: Select Screen
↑ ↓: Select Item
Enter>Select
+/-: Change Opt.
F1:  General Help
F2:  Previous Values
F3:  Optimized Defaults
F4:  Save & Exit
ESC: Exit

Version 2.17.1249. Copyright (C) 2016 American Megatrends, Inc.
```

### BIOS Menu 22:Exit

#### ➔ Save Changes and Reset

Use the **Save Changes and Reset** option to save the changes made to the BIOS options and to exit the BIOS configuration setup program.

#### ➔ Discard Changes and Reset

Use the **Discard Changes and Reset** option to exit the system without saving the changes made to the BIOS configuration setup program.

#### ➔ Restore Defaults

Use the **Restore Defaults** option to load the optimal default values for each of the parameters on the Setup menus. **F3 key can be used for this operation.**

## TANK-610-BW Embedded System

➔ Save as User Defaults

Use the **Save as User Defaults** option to save the changes done so far as user defaults.

➔ Restore User Defaults

Use the **Restore User Defaults** option to restore the user defaults to all the setup options.

Appendix

A

# Regulatory Compliance

---

## DECLARATION OF CONFORMITY



This equipment is in conformity with the following EU directives:

- EMC Directive (2004/108/EC, 2014/30/EU)
- Low-Voltage Directive (2006/95/EC, 2014/35/EU)
- RoHS II Directive (2011/65/EU, 2015/863/EU)

If the user modifies and/or install other devices in the equipment, the CE conformity declaration may no longer apply.

If this equipment has telecommunications functionality, it also complies with the requirements of the Radio Equipment Directive 2014/53/EU.

---

English

IEI Integration Corp declares that this equipment is in compliance with the essential requirements and other relevant provisions of Directive 2014/53/EU.

---

Български [Bulgarian]

IEI Integration Corp. декларира, че този оборудване е в съответствие със съществените изисквания и другите приложим правила на Директива 2014/53/EU.

---

Česky [Czech]

IEI Integration Corp tímto prohlašuje, že tento zařizení je ve shodě s základními požadavky a dalšími příslušnými ustanoveními směrnice 2014/53/EU.

---

Dansk [Danish]

IEI Integration Corp erklærer herved, at følgende udstyr overholder de væsentlige krav og øvrige relevante krav i direktiv 2014/53/EU.

---

---

**Deutsch [German]**

IEI Integration Corp, erklärt dieses Gerät entspricht den grundlegenden Anforderungen und den weiteren entsprechenden Vorgaben der Richtlinie 2014/53/EU.

---

**Eesti [Estonian]**

IEI Integration Corp deklareerib seadme seadme vastavust direktiivi 2014/53/EÜ põhinõuetele ja nimetatud direktiivist tulenevatele teistele asjakohastele sätetele.

---

**Español [Spanish]**

IEI Integration Corp declara que el equipo cumple con los requisitos esenciales y cualesquiera otras disposiciones aplicables o exigibles de la Directiva 2014/53/EU.

---

**Ελληνική [Greek]**

IEI Integration Corp ΔΗΛΩΝΕΙ ΟΤΙ ΕΞΟΠΛΙΣΜΟΣ ΣΥΜΜΟΡΦΩΝΕΤΑΙ ΠΡΟΣ ΤΙΣ ΟΥΣΙΩΔΕΙΣ ΑΠΑΙΤΗΣΕΙΣ ΚΑΙ ΤΙΣ ΛΟΙΠΕΣ ΣΧΕΤΙΚΕΣ ΔΙΑΤΑΞΕΙΣ ΤΗΣ ΟΔΗΓΙΑΣ 2014/53/EU.

---

**Français [French]**

IEI Integration Corp déclare que l'appareil est conforme aux exigences essentielles et aux autres dispositions pertinentes de la directive 2014/53/EU.

---

**Italiano [Italian]**

IEI Integration Corp dichiara che questo apparecchio è conforme ai requisiti essenziali ed alle altre disposizioni pertinenti stabilite dalla direttiva 2014/53/EU.

---

**Latviski [Latvian]**

IEI Integration Corp deklarē, ka iekārta atbilst būtiskajām prasībām un citiem ar to saistītajiem noteikumiem Direktīvas 2014/53/EU.

---

## TANK-610-BW Embedded System

---

Lietuvių [Lithuanian]

IEI Integration Corp deklaruoja, kad šis įranga atitinka esminius reikalavimus ir kitas 2014/53/EU Direktyvos nuostatas.

---

Nederlands [Dutch]

IEI Integration Corp dat het toestel toestel in overeenstemming is met de essentiële eisen en de andere relevante bepalingen van richtlijn 2014/53/EU.

---

Malti [Maltese]

IEI Integration Corp jiddikjara li dan prodott jikkonforma mal-ħtiġijiet essenzjali u ma provvedimenti oħrajn relevanti li hemm fid-Dirrettiva 2014/53/EU.

---

Magyar [Hungarian]

IEI Integration Corp nyilatkozom, hogy a berendezés megfelel a vonatkozó alapvető követelményeknek és az 2014/53/EU irányelv egyéb előírásainak.

---

Polski [Polish]

IEI Integration Corp oświadcza, że wyrobu jest zgodny z zasadniczymi wymogami oraz pozostałymi stosownymi postanowieniami Dyrektywy 2014/53/EU.

---

Português [Portuguese]

IEI Integration Corp declara que este equipamento está conforme com os requisitos essenciais e outras disposições da Directiva 2014/53/EU.

---

Româna [Romanian]

IEI Integration Corp declară că acest echipament este în conformitate cu cerințele esențiale și cu celelalte prevederi relevante ale Directivei 2014/53/EU.

---

---

Slovensko [Slovenian]

IEI Integration Corp izjavlja, da je ta opreme v skladu z bistvenimi zahtevami in ostalimi relevantnimi določili direktive 2014/53/EU.

---

Slovensky [Slovak]

IEI Integration Corp týmto vyhlasuje, že zariadenia spĺňa základné požiadavky a všetky príslušné ustanovenia Smernice 2014/53/EU.

---

Suomi [Finnish]

IEI Integration Corp vakuuttaa täten että laitteet on direktiivin 2014/53/EU oleellisten vaatimusten ja sitä koskevien direktiivin muiden ehtojen mukainen.

---

Svenska [Swedish]

IEI Integration Corp förklarar att denna utrustningstyp står i överensstämmelse med de väsentliga egenskapskrav och övriga relevanta bestämmelser som framgår av direktiv 2014/53/EU.

---

FCC WARNING



This equipment complies with Part 15 of the FCC Rules. Operation is subject to the following two conditions:

- This device may not cause harmful interference, and
- This device must accept any interference received, including interference that may cause undesired operation.

This equipment has been tested and found to comply with the limits for a Class A digital device, pursuant to part 15 of the FCC Rules. These limits are designed to provide reasonable protection against harmful interference when the equipment is operated in a commercial environment. This equipment generates, uses, and can radiate radio frequency energy and, if not installed and used in accordance with the instruction manual, may cause harmful interference to radio communications. Operation of this equipment in a residential area is likely to cause harmful interference in which case the user will be required to correct the interference at his own expense.



### **Federal Communication Commission Interference Statement**

This equipment has been assembled with components that comply with the limits for a Class B digital device, pursuant to Part 15 of the FCC Rules. These limits are designed to provide reasonable protection against harmful interference in a residential installation. This equipment generates, uses and can radiate radio frequency energy and, if not installed and used in accordance with the instructions, may cause harmful interference to radio communications. However, there is no guarantee that interference will not occur in a particular installation. If this equipment does cause harmful interference to radio or television reception, which can be determined by turning the equipment off and on, the user is encouraged to try to correct the interference by one of the following measures:

- Reorient or relocate the receiving antenna.
- Increase the separation between the equipment and receiver.
- Connect the equipment into an outlet on a circuit different from that to which the receiver is connected.
- Consult the dealer or an experienced radio/TV technician for help.

**Appendix**

**B**

# Safety Precautions

---

**WARNING:**

The precautions outlined in this chapter should be strictly followed. Failure to follow these precautions may result in permanent damage to the TANK-610-BW.

## B.1 Safety Precautions

Please follow the safety precautions outlined in the sections that follow:

### B.1.1 General Safety Precautions

Please ensure the following safety precautions are adhered to at all times.

- **Follow the electrostatic precautions** outlined below whenever the TANK-610-BW is opened.
- **Make sure the power is turned off and the power cord is disconnected** whenever the TANK-610-BW is being installed, moved or modified.
- **Do not apply voltage levels that exceed the specified voltage range.** Doing so may cause fire and/or an electrical shock.
- **Electric shocks can occur** if the TANK-610-BW chassis is opened when the TANK-610-BW is running.
- **Do not drop or insert any objects** into the ventilation openings of the TANK-610-BW.
- **If considerable amounts of dust, water, or fluids enter the TANK-610-BW,** turn off the power supply immediately, unplug the power cord, and contact the TANK-610-BW vendor.
- **DO NOT:**
  - Drop the TANK-610-BW against a hard surface.
  - Strike or exert excessive force onto the system.
  - Touch any of the system with a sharp object
  - In a site where the ambient temperature exceeds the rated temperature

### B.1.2 Anti-static Precautions

---



#### WARNING:

Failure to take ESD precautions during the installation of the TANK-610-BW may result in permanent damage to the TANK-610-BW and severe injury to the user.

---

Electrostatic discharge (ESD) can cause serious damage to electronic components, including the TANK-610-BW. Dry climates are especially susceptible to ESD. It is therefore critical that whenever the TANK-610-BW is opened and any of the electrical components are handled, the following anti-static precautions are strictly adhered to.

- ***Wear an anti-static wristband:*** Wearing a simple anti-static wristband can help to prevent ESD from damaging any electrical component.
- ***Self-grounding:*** Before handling any electrical component, touch any grounded conducting material. During the time the electrical component is handled, frequently touch any conducting materials that are connected to the ground.
- ***Use an anti-static pad:*** When configuring or working with an electrical component, place it on an anti-static pad. This reduces the possibility of ESD damage.
- ***Only handle the edges of the electrical component:*** When handling the electrical component, hold the electrical component by its edges.

## TANK-610-BW Embedded System

### B.1.3 Product Disposal

---



#### **CAUTION:**

Risk of explosion if battery is replaced by an incorrect type. Only certified engineers should replace the on-board battery.

Dispose of used batteries according to instructions and local regulations.

---

- Outside the European Union - If you wish to dispose of used electrical and electronic products outside the European Union, please contact your local authority so as to comply with the correct disposal method.
- Within the European Union - The device that produces less waste and is easier to recycle is classified as electronic device in terms of the European Directive 2012/19/EU (WEEE), and must not be disposed of as domestic garbage.

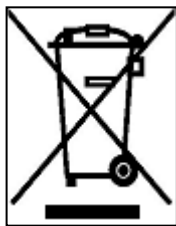

EU-wide legislation, as implemented in each Member State, requires that waste electrical and electronic products carrying the mark (left) must be disposed of separately from normal household waste. This includes monitors and electrical accessories, such as signal cables or power cords. When you need to dispose of your device, please follow the guidance of your local authority, or ask the shop where you purchased the product. The mark on electrical and electronic products only applies to the current European Union Member States.

Please follow the national guidelines for electrical and electronic product disposal.

## B.2 Maintenance and Cleaning Precautions

When maintaining or cleaning the TANK-610-BW, please follow the guidelines below.

### B.2.1 Maintenance and Cleaning

Prior to cleaning any part or component of the TANK-610-BW, please read the details below.

- The interior of the TANK-610-BWX does not require cleaning. Keep fluids away from the TANK-610-BW interior.
- Be cautious of all small removable components when vacuuming the TANK-610-BW.
- Turn the TANK-610-BW off before cleaning the TANK-610-BW.
- Never drop any objects or liquids through the openings of the TANK-610-BW.
- Be cautious of any possible allergic reactions to solvents or chemicals used when cleaning the TANK-610-BW.
- Avoid eating, drinking and smoking within vicinity of the TANK-610-BW.

### B.2.2 Cleaning Tools

Some components in the TANK-610-BW may only be cleaned using a product specifically designed for the purpose. In such case, the product will be explicitly mentioned in the cleaning tips. Below is a list of items to use when cleaning the TANK-610-BW.

- **Cloth** – Although paper towels or tissues can be used, a soft, clean piece of cloth is recommended when cleaning the TANK-610-BW.
- **Water or rubbing alcohol** – A cloth moistened with water or rubbing alcohol can be used to clean the TANK-610-BW.
- **Using solvents** – The use of solvents is not recommended when cleaning the TANK-610-BW as they may damage the plastic parts.
- **Vacuum cleaner** – Using a vacuum specifically designed for computers is one of the best methods of cleaning the TANK-610-BW. Dust and dirt can restrict the airflow in the TANK-610-BW and cause its circuitry to corrode.
- **Cotton swabs** - Cotton swabs moistened with rubbing alcohol or water are excellent tools for wiping hard to reach areas.
- **Foam swabs** - Whenever possible, it is best to use lint free swabs such as foam swabs for cleaning.

Appendix

C

# BIOS Options

---

Below is a list of BIOS configuration options in the BIOS chapter.

- ➔ **System Date [xx/xx/xx] .....48**
- ➔ **System Time [xx:xx:xx] .....48**
- ➔ **ACPI Sleep State [S1 (CPU Stop Clock)] .....49**
- ➔ **Serial Port [Enabled].....51**
- ➔ **Change Settings [Auto] .....51**
- ➔ **Serial Port [Enabled].....52**
- ➔ **Change Settings [Auto] .....52**
- ➔ **Serial Port [Enabled].....53**
- ➔ **Change Settings [Auto] .....53**
- ➔ **Serial Port [Enabled].....54**
- ➔ **Change Settings [Auto] .....54**
- ➔ **Serial Port [Enabled].....55**
- ➔ **Change Settings [Auto] .....55**
- ➔ **Device Mode [RS232].....55**
- ➔ **Serial Port [Enabled].....56**
- ➔ **Change Settings [Auto] .....56**
- ➔ **Device Mode [RS232].....57**
- ➔ **PC Health Status .....57**
- ➔ **Serial Port [Enabled].....59**
- ➔ **Change Settings [Auto] .....59**
- ➔ **Serial Port [Enabled].....60**
- ➔ **Change Settings [Auto] .....60**
- ➔ **Wake System with Fixed Time [Disabled] .....62**
- ➔ **Console Redirection [Disabled].....63**
- ➔ **Terminal Type [ANSI].....64**
- ➔ **Bits per second [115200].....65**
- ➔ **Data Bits [8] .....65**
- ➔ **Parity [None].....65**
- ➔ **Stop Bits [1] .....66**
- ➔ **Auto Recovery Function [Disabled] .....66**
- ➔ **Auto Recovery Status [Enabled] .....67**
- ➔ **Recovery from Local [Disabled].....67**
- ➔ **Intel Virtualization Technology [Disabled] .....68**



## TANK-610-BW Embedded System

➔	<b>SATA Controller [Enabled]</b> .....	<b>69</b>
➔	<b>SATA Mode Selection [AHCI]</b> .....	<b>69</b>
➔	<b>Hot Plug [Disabled]</b> .....	<b>69</b>
➔	<b>USB Devices</b> .....	<b>70</b>
➔	<b>Legacy USB Support [Enabled]</b> .....	<b>70</b>
➔	<b>Primary Display [Auto]</b> .....	<b>73</b>
➔	<b>Primary IGFX Boot Display [Auto]</b> .....	<b>73</b>
➔	<b>DVMT Pre-Allocated [32MB]</b> .....	<b>73</b>
➔	<b>DVMT Total Gfx Mem [256M]</b> .....	<b>74</b>
➔	<b>Audio Controller [Enabled]</b> .....	<b>75</b>
➔	<b>Administrator Password</b> .....	<b>75</b>
➔	<b>User Password</b> .....	<b>75</b>
➔	<b>Bootup NumLock State [On]</b> .....	<b>76</b>
➔	<b>Quiet Boot [Enabled]</b> .....	<b>77</b>
➔	<b>Boot Option filter [Legacy only]</b> .....	<b>77</b>
➔	<b>Network [UEFI]</b> .....	<b>77</b>
➔	<b>Option ROM Messages [Force BIOS]</b> .....	<b>77</b>
➔	<b>Save Changes and Reset</b> .....	<b>78</b>
➔	<b>Discard Changes and Reset</b> .....	<b>78</b>
➔	<b>Restore Defaults</b> .....	<b>78</b>
➔	<b>Save as User Defaults</b> .....	<b>79</b>
➔	<b>Restore User Defaults</b> .....	<b>79</b>

Appendix

D

# Terminology

---

## TANK-610-BW Embedded System

AC '97	Audio Codec 97 (AC'97) refers to a codec standard developed by Intel® in 1997.
ACPI	Advanced Configuration and Power Interface (ACPI) is an OS-directed configuration, power management, and thermal management interface.
AHCI	Advanced Host Controller Interface (AHCI) is a SATA Host controller register-level interface.
ATA	The Advanced Technology Attachment (ATA) interface connects storage devices including hard disks and CD-ROM drives to a computer.
ARMD	An ATAPI Removable Media Device (ARMD) is any ATAPI device that supports removable media, besides CD and DVD drives.
ASKIR	Amplitude Shift Keyed Infrared (ASKIR) is a form of modulation that represents a digital signal by varying the amplitude (“volume”) of the signal. A low amplitude signal represents a binary 0, while a high amplitude signal represents a binary 1.
BIOS	The Basic Input/Output System (BIOS) is firmware that is first run when the computer is turned on and can be configured by the end user
CODEC	The Compressor-Decompressor (CODEC) encodes and decodes digital audio data on the system.
CompactFlash®	CompactFlash® is a solid-state storage device. CompactFlash® devices use flash memory in a standard size enclosure. Type II is thicker than Type I, but a Type II slot can support both types.
CMOS	Complimentary metal-oxide-conductor is an integrated circuit used in chips like static RAM and microprocessors.
COM	COM refers to serial ports. Serial ports offer serial communication to expansion devices. The serial port on a personal computer is usually a male D-sub 9 connector.
DAC	The Digital-to-Analog Converter (DAC) converts digital signals to analog signals.
DDR	Double Data Rate refers to a data bus transferring data on both the rising and falling edges of the clock signal.

DMA	Direct Memory Access (DMA) enables some peripheral devices to bypass the system processor and communicate directly with the system memory.
DIMM	Dual Inline Memory Modules are a type of RAM that offer a 64-bit data bus and have separate electrical contacts on each side of the module.
DIO	The digital inputs and digital outputs are general control signals that control the on/off circuit of external devices or TTL devices. Data can be read or written to the selected address to enable the DIO functions.
EHCI	The Enhanced Host Controller Interface (EHCI) specification is a register-level interface description for USB 2.0 Host Controllers.
EIDE	Enhanced IDE (EIDE) is a newer IDE interface standard that has data transfer rates between 4.0 MBps and 16.6 MBps.
EIST	Enhanced Intel® SpeedStep Technology (EIST) allows users to modify the power consumption levels and processor performance through application software. The application software changes the bus-to-core frequency ratio and the processor core voltage.
FSB	The Front Side Bus (FSB) is the bi-directional communication channel between the processor and the Northbridge chipset.
GbE	Gigabit Ethernet (GbE) is an Ethernet version that transfers data at 1.0 Gbps and complies with the IEEE 802.3-2005 standard.
GPIO	General purpose input
HDD	Hard disk drive (HDD) is a type of magnetic, non-volatile computer storage device that stores digitally encoded data.
ICH	The Input/Output Control Hub (ICH) is an Intel® Southbridge chipset.
IrDA	Infrared Data Association (IrDA) specify infrared data transmission protocols used to enable electronic devices to wirelessly communicate with each other.
L1 Cache	The Level 1 Cache (L1 Cache) is a small memory cache built into the system processor.
L2 Cache	The Level 2 Cache (L2 Cache) is an external processor memory cache.

## TANK-610-BW Embedded System

LCD	Liquid crystal display (LCD) is a flat, low-power display device that consists of two polarizing plates with a liquid crystal panel in between.
LVDS	Low-voltage differential signaling (LVDS) is a dual-wire, high-speed differential electrical signaling system commonly used to connect LCD displays to a computer.
POST	The Power-on Self Test (POST) is the pre-boot actions the system performs when the system is turned-on.
RAM	Random Access Memory (RAM) is volatile memory that loses data when power is lost. RAM has very fast data transfer rates compared to other storage like hard drives.
SATA	Serial ATA (SATA) is a serial communications bus designed for data transfers between storage devices and the computer chipsets. The SATA bus has transfer speeds up to 1.5 Gbps and the SATA II bus has data transfer speeds of up to 3.0 Gbps.
S.M.A.R.T	Self Monitoring Analysis and Reporting Technology (S.M.A.R.T) refers to automatic status checking technology implemented on hard disk drives.
UART	Universal Asynchronous Receiver-transmitter (UART) is responsible for asynchronous communications on the system and manages the system's serial communication (COM) ports.
UHCI	The Universal Host Controller Interface (UHCI) specification is a register-level interface description for USB 1.1 Host Controllers.
USB	The Universal Serial Bus (USB) is an external bus standard for interfacing devices. USB 1.1 supports 12Mbps data transfer rates and USB 2.0 supports 480Mbps data transfer rates.
VGA	The Video Graphics Array (VGA) is a graphics display system developed by IBM.

Appendix

**E**

# Watchdog Timer

---



**NOTE:**

The following discussion applies to DOS. Contact IEI support or visit the IEI website for drivers for other operating systems.

The Watchdog Timer is a hardware-based timer that attempts to restart the system when it stops working. The system may stop working because of external EMI or software bugs. The Watchdog Timer ensures that standalone systems like ATMs will automatically attempt to restart in the case of system problems.

A BIOS function call (INT 15H) is used to control the Watchdog Timer.

INT 15H:

AH – 6FH Sub-function:	
AL – 2:	Sets the Watchdog Timer's period.
BL:	Time-out value (Its unit-second is dependent on the item "Watchdog Timer unit select" in CMOS setup).

**Table E-1: AH-6FH Sub-function**

Call sub-function 2 to set the time-out period of Watchdog Timer first. If the time-out value is not zero, the Watchdog Timer starts counting down. When the timer value reaches zero, the system resets. To ensure that this reset condition does not occur, calling sub-function 2 must periodically refresh the Watchdog Timer. However, the watchdog timer is disabled if the time-out value is set to zero.

A tolerance of at least 10% must be maintained to avoid unknown routines within the operating system (DOS), such as disk I/O that can be very time-consuming.

**NOTE:**

The Watchdog Timer is activated through software. The software application that activates the Watchdog Timer must also deactivate it when closed. If the Watchdog Timer is not deactivated, the system will automatically restart after the Timer has finished its countdown.

**EXAMPLE PROGRAM:****; INITIAL TIMER PERIOD COUNTER**

;

**W\_LOOP:**

;

```
MOV      AX, 6F02H      ;setting the time-out value
MOV      BL, 30         ;time-out value is 48 seconds
INT      15H
```

;

**; ADD THE APPLICATION PROGRAM HERE**

;

```
CMP      EXIT_AP, 1     ;is the application over?
JNE      W_LOOP         ;No, restart the application
```

```
MOV      AX, 6F02H      ;disable Watchdog Timer
MOV      BL, 0          ;
INT      15H
```

;

**; EXIT ;**



Appendix

F

# Hazardous Materials Disclosure

---

The details provided in this appendix are to ensure that the product is compliant with the Peoples Republic of China (China) RoHS standards. The table below acknowledges the presences of small quantities of certain materials in the product, and is applicable to China RoHS only.

A label will be placed on each product to indicate the estimated “Environmentally Friendly Use Period” (EFUP). This is an estimate of the number of years that these substances would “not leak out or undergo abrupt change.” This product may contain replaceable sub-assemblies/components which have a shorter EFUP such as batteries and lamps. These components will be separately marked.

Please refer to the following table.

Part Name	Toxic or Hazardous Substances and Elements					
	Lead (Pb)	Mercury (Hg)	Cadmium (Cd)	Hexavalent Chromium (CR(VI))	Polybrominated Biphenyls (PBB)	Polybrominated Diphenyl Ethers (PBDE)
Housing	O	O	O	O	O	O
Display	O	O	O	O	O	O
Printed Circuit Board	O	O	O	O	O	O
Metal Fasteners	O	O	O	O	O	O
Cable Assembly	O	O	O	O	O	O
Fan Assembly	O	O	O	O	O	O
Power Supply Assemblies	O	O	O	O	O	O
Battery	O	O	O	O	O	O

O: This toxic or hazardous substance is contained in all of the homogeneous materials for the part is below the limit requirement in SJ/T11363-2006 (now replaced by GB/T 26572-2011).

X: This toxic or hazardous substance is contained in at least one of the homogeneous materials for this part is above the limit requirement in SJ/T11363-2006 (now replaced by GB/T 26572-2011).

## TANK-610-BW Embedded System

此附件旨在确保本产品符合中国 RoHS 标准。以下表格标示此产品中某有毒物质的含量符合中国 RoHS 标准规定的限量要求。

本产品上会附有“环境友好使用期限”的标签，此期限是估算这些物质“不会有泄漏或突变”的年限。本产品可能包含有较短的环境友好使用期限的可替换元件，像是电池或灯管，这些元件将会单独标示出来。

部件名称	有毒有害物质或元素					
	铅 (Pb)	汞 (Hg)	镉 (Cd)	六价铬 (CR(VI))	多溴联苯 (PBB)	多溴二苯 醚 (PBDE)
壳体	○	○	○	○	○	○
显示	○	○	○	○	○	○
印刷电路板	○	○	○	○	○	○
金属螺帽	○	○	○	○	○	○
电缆组装	○	○	○	○	○	○
风扇组装	○	○	○	○	○	○
电力供应组装	○	○	○	○	○	○
电池	○	○	○	○	○	○

○: 表示该有毒有害物质在该部件所有物质材料中的含量均在 SJ/T 11363-2006 (现由 GB/T 26572-2011 取代) 标准规定的限量要求以下。

X: 表示该有毒有害物质至少在该部件的某一均质材料中的含量超出 SJ/T 11363-2006 (现由 GB/T 26572-2011 取代) 标准规定的限量要求。