



# PUZZLE-M801

---

## Next-Gen Network

[www.ieiworld.com](http://www.ieiworld.com)





## IEI PUZZLE Series

# Aiming to The Future with Next Generation Network Appliance

### Proprietary Network Appliance

A proprietary network appliance is a specialized electronic device that plugs into a network that is optimized for one specialized network purpose like switching, routing or protecting in a network environment. Proprietary network appliances include router, load balance, bandwidth management, gateway security, WAN optimization, application delivery controller (ADC), next-generation firewall (NGFW), unified threat management (UTM) and intrusion detection system (IDS).

### uCPE (Universal Customer Premise Equipment)

uCPE consists of virtual network functions (VNFs) running on a standard operating system hosted on an open server with NFV technology.

Now with NFV technology, we can create several virtual machines and install these VNFs in a x86 or ARM based uCPE. VNFs could include popular software services such as a virtual firewall, virtual load-balancing, or other software-defined wide area network (SD-WAN) service. In addition to NFV orchestration, uCPU could be an edge computing system or an AI inference computing system.

# Software-Defined Network (SDN)

## SDN is a Booming Trend

Software-defined network (SDN) has been dominant in nowadays network technology such as appliances of NGFW and universal CPE. The new technology is developed on the basis of hardware virtualization and advanced data plane to support high-performance packet processing. Meanwhile, it enables one piece of universal hardware platform to perform multiple network functions by utilizing virtualization technology instead of applying a number of specific hardware, which greatly decreases total cost of ownership (TCO) to deploy and manage in next generation network.

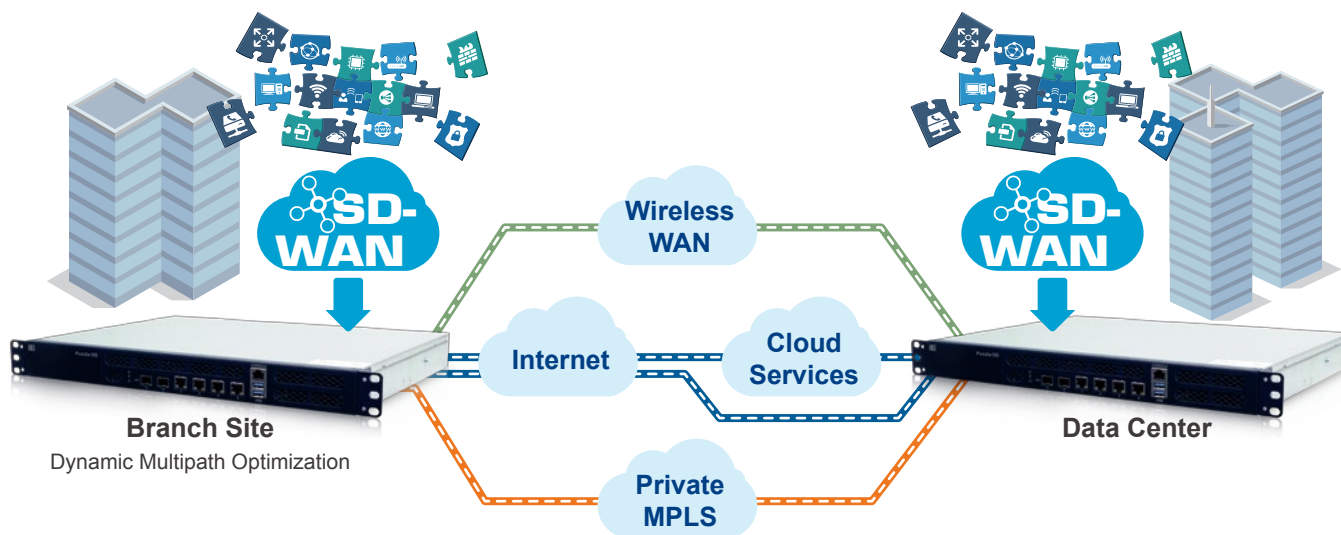

## SDN Eco-System

The fundamental capability to achieve software-defined network (SDN) is network processing optimization via application running in user space by utilizing virtualization technology, which requires the combination of software and compatible hardware to operate together. As shown in Figure A, it outlines a system architecture and illustrates a few projects, groups and companies that work in specific spaces. Some mainly contribute to software-wise part, but some are solution providers that make their proprietary work public such as Intel's DPDK and Cisco's VPP for FD.io project.

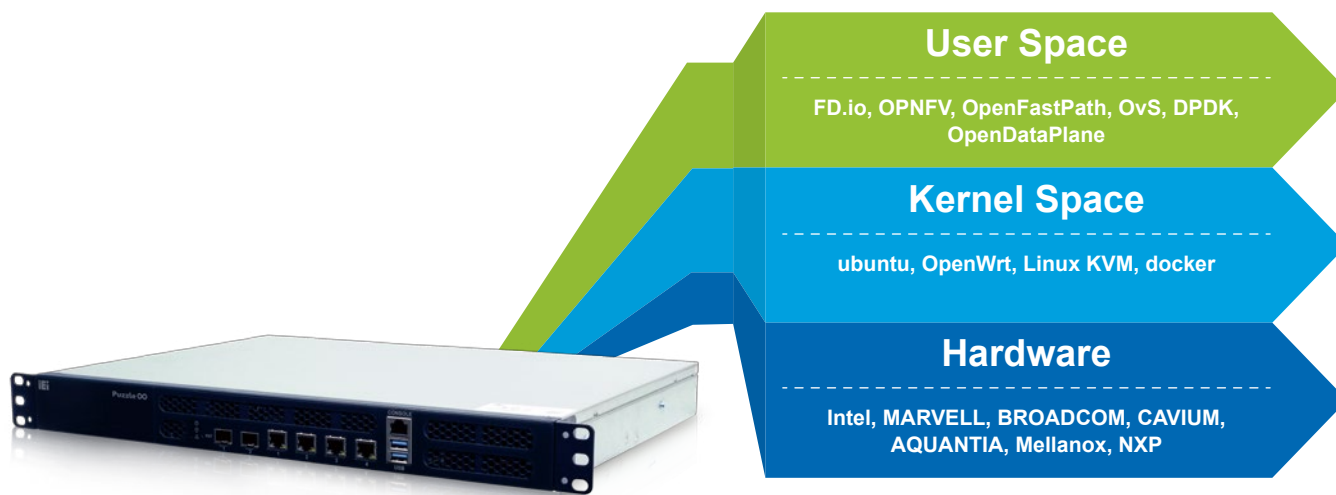
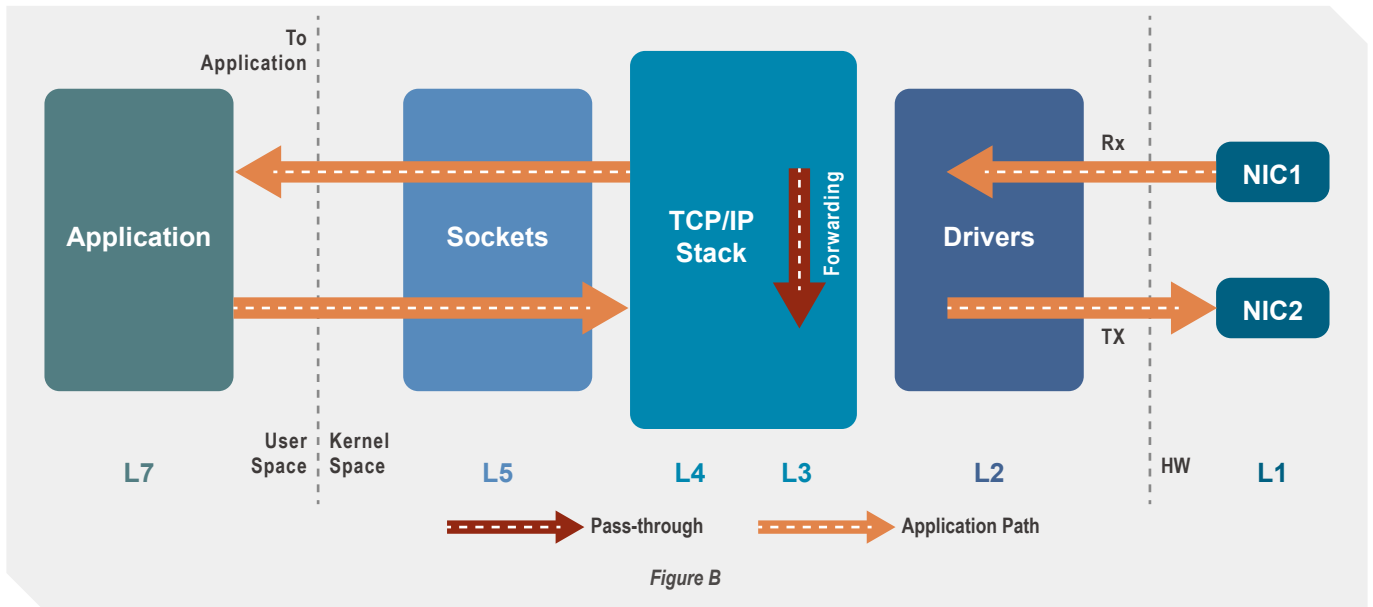

Figure A

## Why SDN? Surging Network Traffic

The story begins with “Big Data”, which estimates up to 40ZB (1ZB = 1024GB) network traffic generated from IoT and Industrial 4.0 by 2025. Next, 5G will join the party and is expected to bring tremendous traffic to the network. Consequently, rapid-growth network traffic increases the burden to generic kernel and causes it scramble to perform packet process.

Software can operate with high-performance on nowadays powerful CPU/SoC by utilizing more threads and cores, but generic kernel stack slows down the throughput dramatically. As shown in Figure B, the bottleneck comes from a few factors including kernel network stack is not optimized for forwarding, code is too generic and networking stack today is a huge part of the kernel.



## Fast-Path Implementation

Fast-path implementation requires data path being processed in user space with correspondent application and to be kernel independent. As shown in Figure C as an example, it depicts a fast-path that accelerates packet forwarding between NICs by utilizing DPDK and a slow-path that goes through Linux networking stack as comparison. The performance is greatly upgraded as DPDK fast-path is cache and minimum instructions optimized. It's counter-part known as OpenDataPlane (ODP) also develops support for more software-defined functions and is compatible with DPDK implementation.

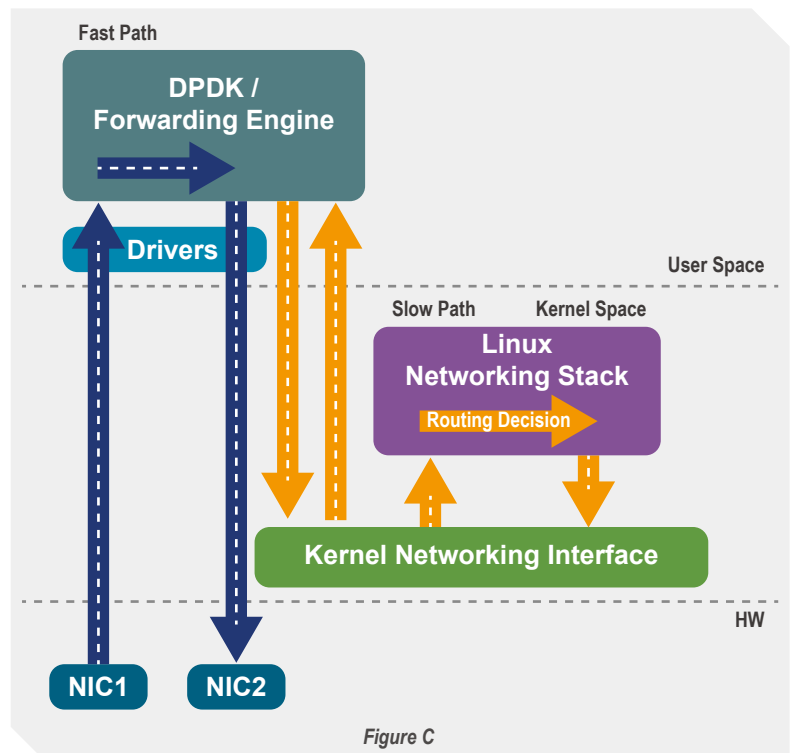

## SDN Pipeline Illustration

Figure D illustrates filtered packets would go for software-defined path to application for particular process before being put back to the pipeline while Figure E shows a crypto hardware is performed in the pipeline and is utilized via OpenDataPlane(ODP) software to accelerate IPsec process before going into another function for customized process.

Also, system with physical virtualization capability enables multiple SDN functions to be installed and performed in specified VMs in the same hardware platform. TCO is decreased as the demand on specific network equipment is decreased as well. Those network functions in conventional equipment are virtualized into universal hardware. Take universal customer premise equipment (CPE) as an example. It is an white-box hardware that integrates with software-defined network function virtualization (NFVs) and is estimated to reach CAGR 69.6% by 2021.

Software Defined: OpenDataPlane, partly DPDK event mode

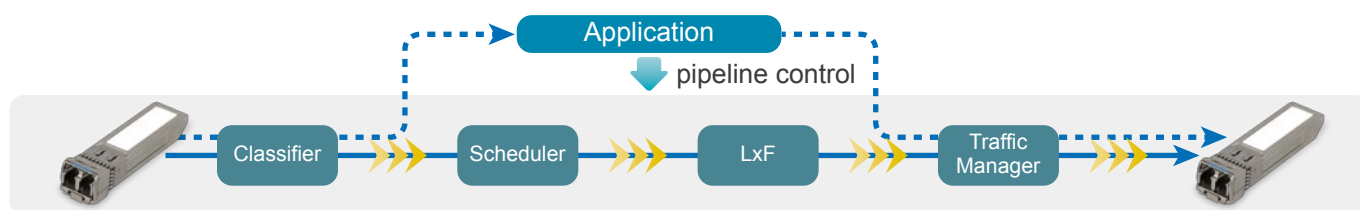

Figure D

IPsec: Software with Crypto Acceleration

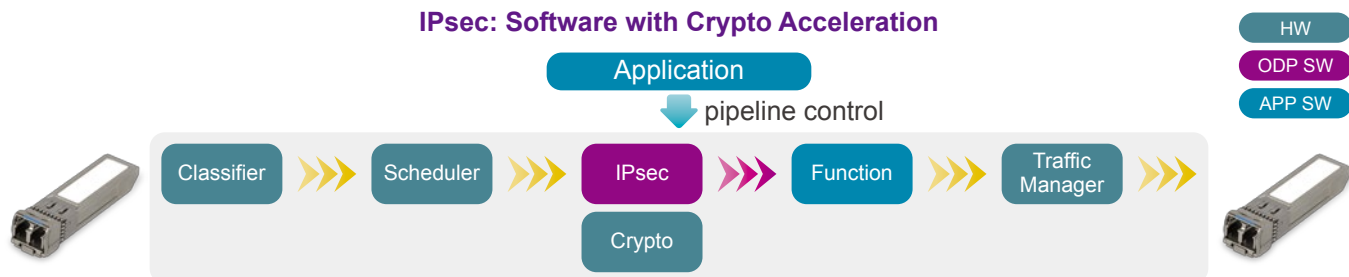

Figure E

## Advanced Hardware is Required for SDN.

SDN by leveraging open-source community's NFV applications brings fundamental change to the way in which networks are implemented. More workloads are moving to the edge of the network in which elevated degree of operation performance is required. To catch up with the trend, an advanced hardware for networking appliance is of vital importance to accelerate software utilization.

Therefore, IEI develops an advanced and high-performance networking platform, the PUZZLE-M801, which is hardware- and driver-ready for prospective SDN service providers.





# PUZZLE-M801

## A New Generation Network Platform

The PUZZLE-M801 is IEI's new generation network platform powered by high-performance and cost-efficient Marvell® ARMADA® 8040 system-on-chip (SoC). The ARMADA® 8040 is based on a quad-core ARM Cortex® – A72 processor and supports full CPU and I/O virtualization. Meanwhile, it includes an advanced packet processor with rich state-of-the-art connectivity including two 10GbE SFP ports, four 1GbE RJ-45 ports and one expansion slot (PCIe x2), making the PUZZLE-M801 ideal for a wild range of IP appliances, data plane applications, virtual CPE and enterprise applications.

Based on ARM v8 architecture, ARMADA® 8040 SoC is capable of realizing various SDN deployment. Advanced Exception Layer (EL) provides support for virtual functions such as Linux KVM and Container with secured or non-secured protection. GIC and SMMU have also been updated to adapt to address translation and interrupt mechanism required in virtual application such as VM, vNIC, vSwitch and SR-IOV.

Besides the support for virtual functions, ARMADA® 8040 SoC is equipped with DPDK compatible Packet Processor hardware, which processes packet parsing, classifying and buffer & descriptor management as shown in Figure F. Its Security Engine provides crypto hardware acceleration for some part of SDN functions such as L2, L3 checksum offload, CRC offload and IPsec handling. Those SoC hardware utilization can be easily operated via Marvell User-space SDK (MUSDK) with RSS function enabled.

The PUZZLE-M801, powered by ARMADA® 8040 SoC, has everything ready for SDN deployment and a variety of network function virtualization (NFVs) with advanced and high-performance hardware.

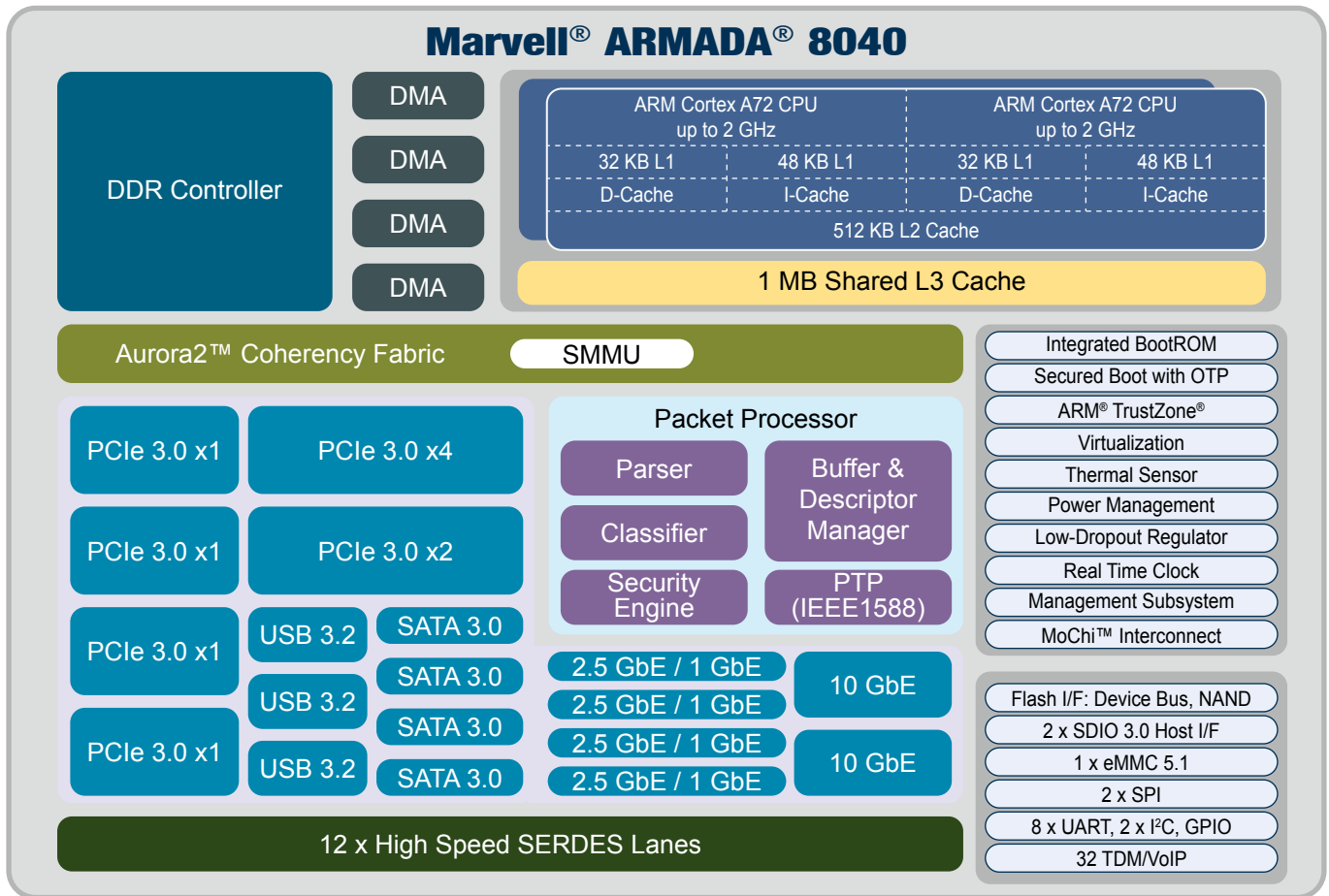
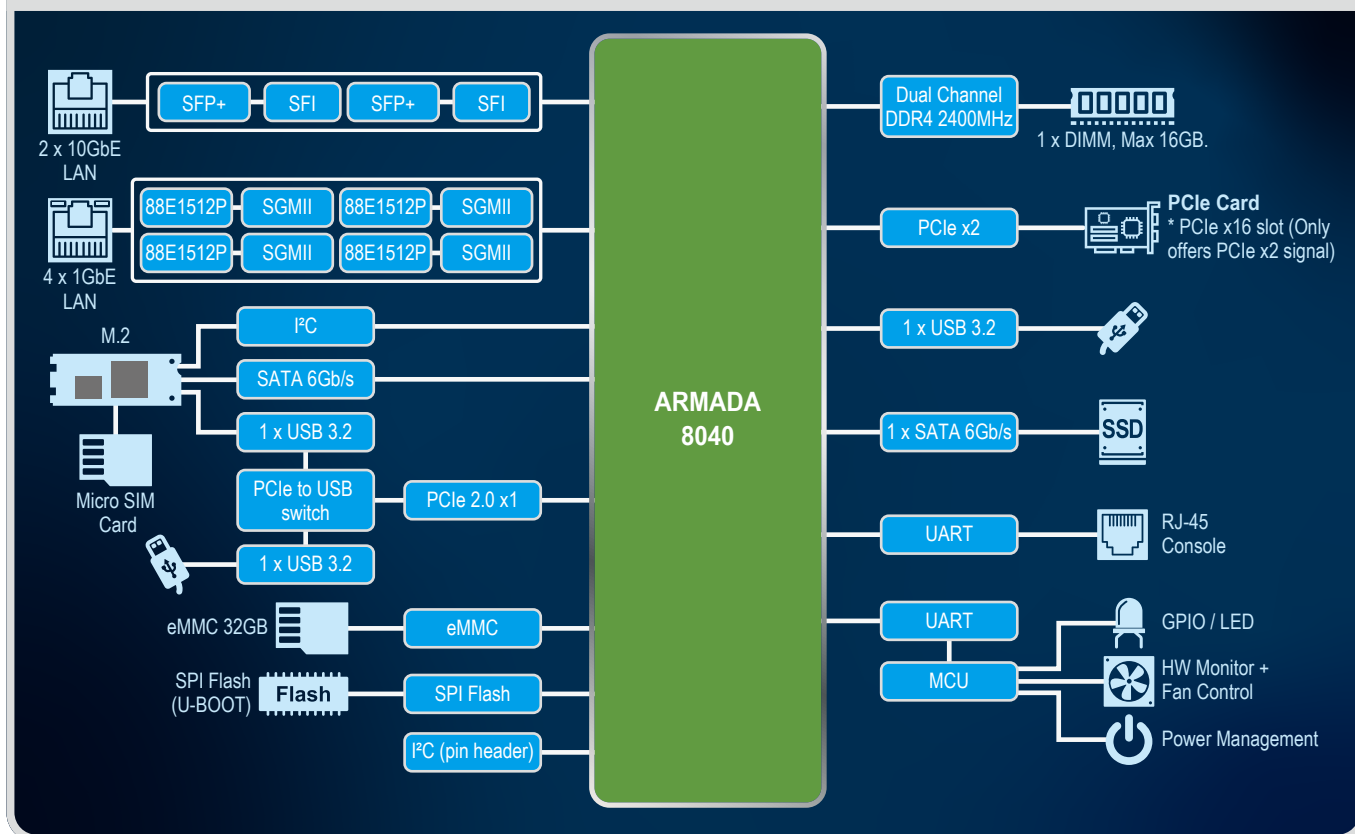

Figure F

## PUZZLE-M801 System Block Diagram



## PUZZLE-M801, uCPE Application

Universal Customer Premise Equipment (uCPE) is one of the most compelling use cases of NFV currently attracting the interest of hosted service providers. It integrates VNFs such as vRouter, vFirewall, vStorage and vWAN-acceleration on one device and brings the benefit including SDN, flexible, easy to manage, better total cost of ownership (TCO) and operational efficiency.

The PUZZLE-M801 is hardware and SDK/BSP ready for service providers to deploy CPE in the field such as branch offices, SOHOs, Retailers and SMBs as shown in Figure G.

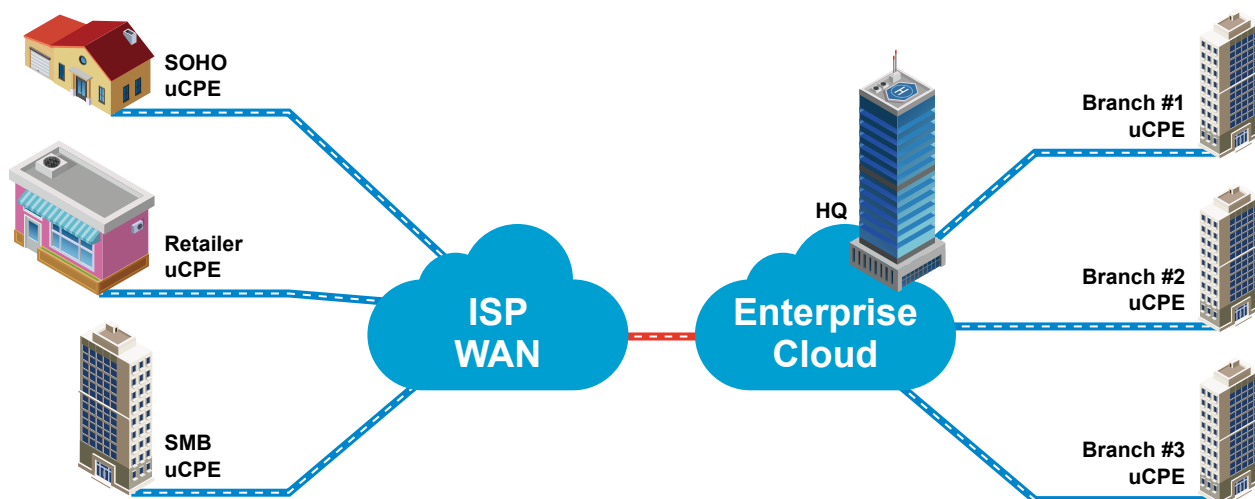

Figure G

## PUZZLE-M801, Software-Defined Forwarding

Equipped with two 10GbE SFP ports, the PUZZLE-M801 provides practical connectivity with network forwarding capability via DPDK for software-defined application running in VM as shown in Figure H.

Moreover, users can configure settings of packet processor, traffic management and hardware offload engine by leveraging Marvell MUSDK.

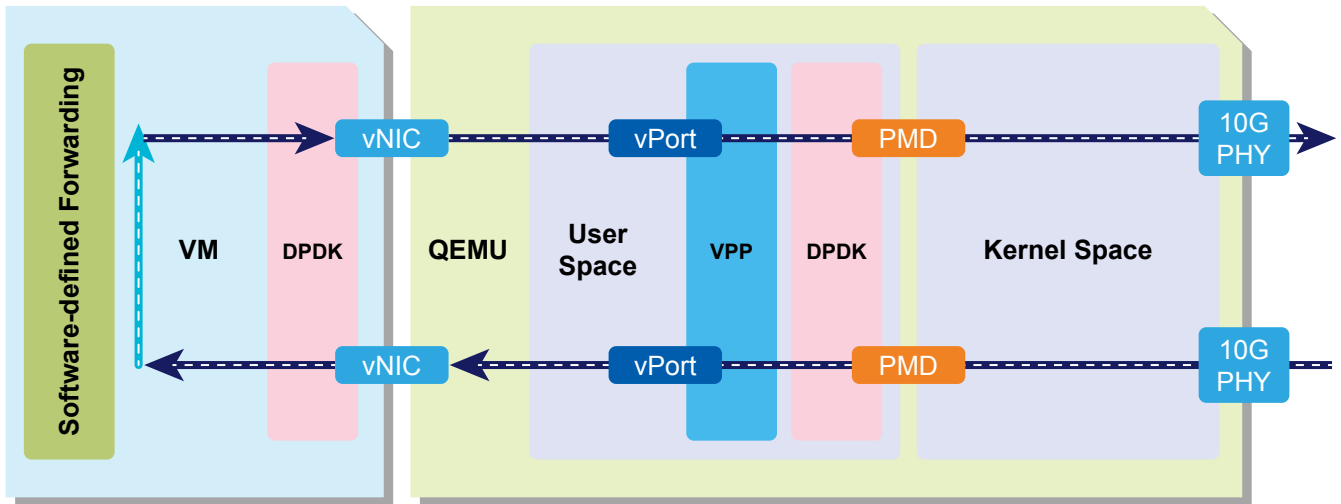

Figure H

## PUZZLE Software Utility

### PUZZLE Finder Software AP

Use your PC/laptop as a development environment.

After installing Ubuntu 16.04 on your PUZZLE, you can install the PUZZLE Finder application on your PC/laptop. PUZZLE Finder can help users quickly develop environment and network applications, and allow them to perform PUZZLE system management, resource monitoring, version maintenance, software installation, software update and gaining information of CPU, memory, Internet, etc.



### Easy to Install

The APP center provides the most popular and configured applications.

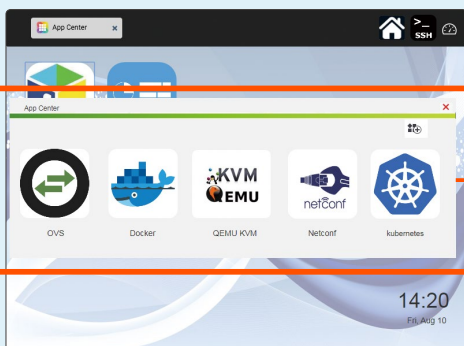

Eliminate cumbersome installation steps; choose the APP you want to install. The APP can be downloaded and automatically installed. You can immediately enjoy the benefits of the software.



# Utilize Virtual Technology, Create Unlimited Value



Docker containerization unlocks the potential for Dev and Ops. Freedom of choice, agile operations and integrated security for legacy and cloud-native applications. Implement Docker Lightweight Micro Services on the IEL PUZZLE.

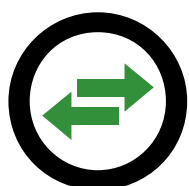

Install the Open vSwitch (OVS) can implement domain cutting, QoS, data monitoring, and support openFlow.



Provide a more efficient Linux virtualization solution. Enhance the efficiency of virtualization by enhancing the operating mode of the CPU through QEMU-KVM.



Automate network configuration with Netconf; accelerate network equipment and services in enterprise in order to lower the cost.



Kubernetes is a system that helps us automate the deployment, expansion, and management of containerized applications.

## PUZZLE System Status Monitoring

Graphical user interface allows you to easily get an overview of the PUZZLE system and monitor resource status of each PUZZLE system you have.



### User Interface



# PUZZLE-M801

## Support Various Expansion Cards

2.5" SSD bay and SATA riser card

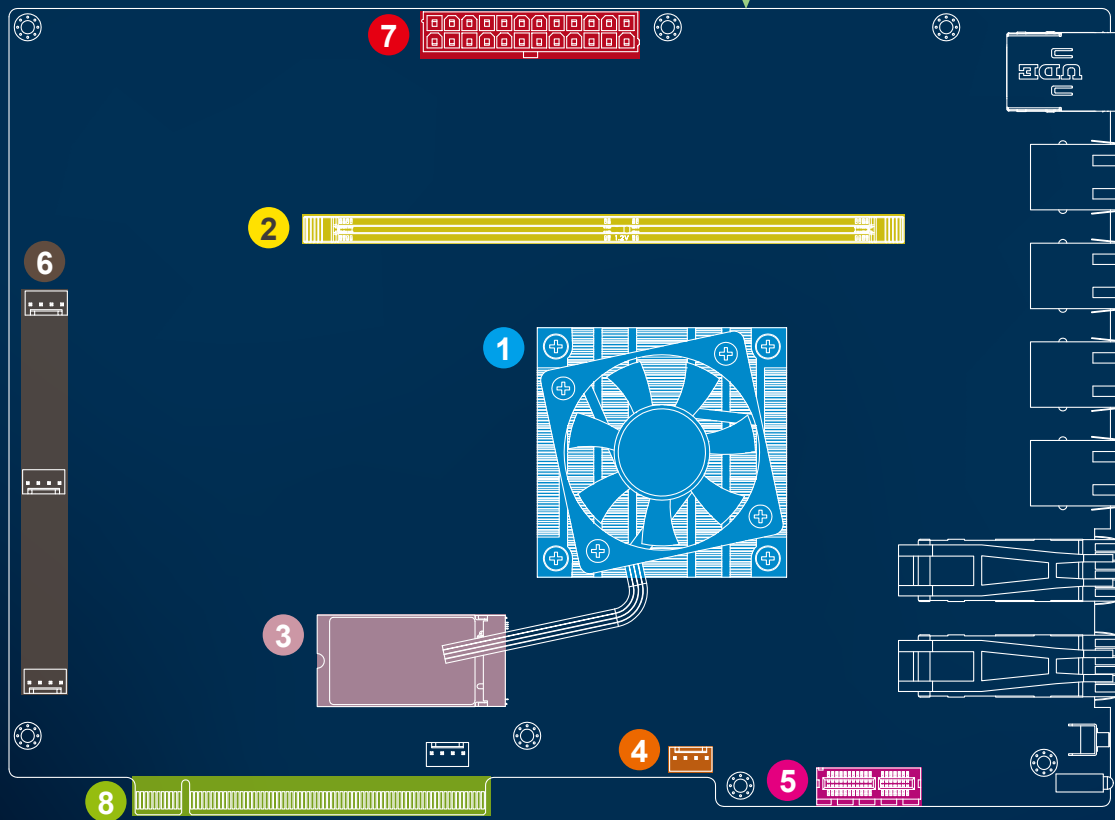
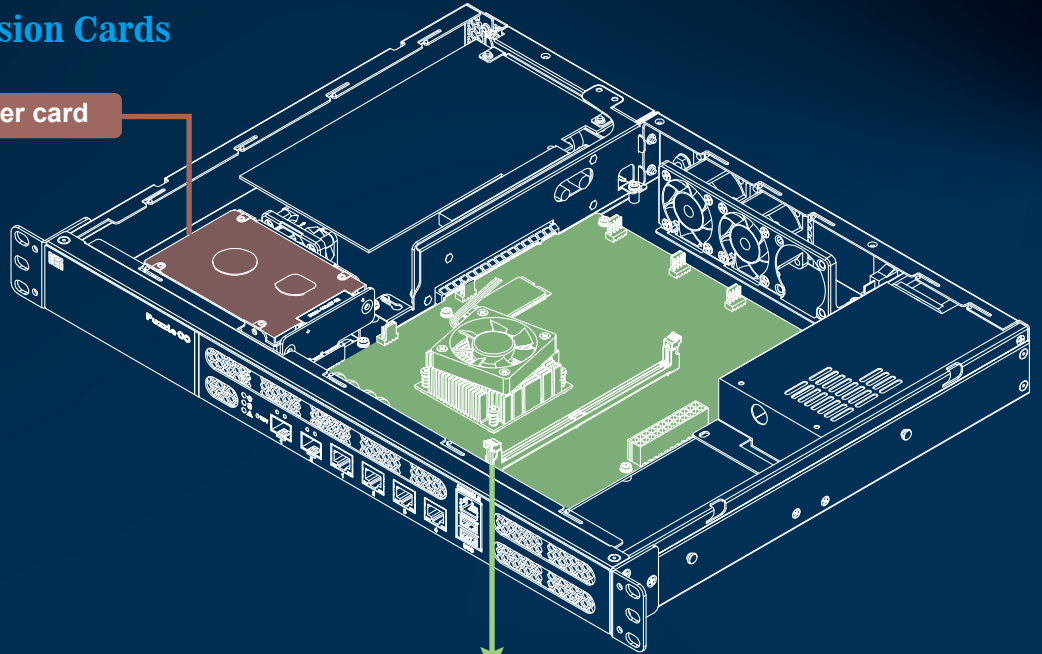

- 1 Marvell® ARMADA® 88F8040 with active cooling
- 2 DDR4 2400MHz DRAM up to 16GB
- 3 M.2, B-key (SATA and USB 3.2) with Micro-SIM slot
- 4 Connector for 2.5" SSD cooling fan (1 fan)
- 5 Connector for SATA riser card (only 1 SATA signal)
- 6 Connectors for system cooling fans (2 fans)
- 7 ATX power connector
- 8 PCIe x2 signal for expansion riser card (x16 mechanically)

# PUZZLE-M801

1U Rackmount Network Appliance with Marvell® ARMADA® 88F8040 High-Performance Quad-Core CPU



## Features

- Marvell® ARMADA® 88F8040 high-performance quad-core System-on-Chip processor
- 2 x 10GbE SFP+ via Marvell® ARMADA® 88F8040
- 4 x GbE RJ-45 via Marvell 88E1512P
- 1 x 288-pin DIMM, DDR4 2400MHz, 16GB (ECC)
- 2 x USB 3.2 Gen 1 (5Gb/s), 1 x RJ-45 console, 1 x M.2 B key (SATA & USB 3.2 Gen 1 (5Gb/s)) with SIM holder, 1 x PCIe x16 slot (PCIe x2 signal)

## Specifications

		PUZZLE-M801
Platform	Form Factor	1U
	CPU	Marvell® ARMADA® 88F8040 high-performance quad-core System-on-Chip processor, 1.6GHz
	Chipset	Integrated in CPU
Memory	Memory Technology	DDR4 2400MHz ECC/Non-ECC/RDIMM
	Memory Capacity	Up to 16GB
	Memory Socket	1 x 288-pin DIMM
Network and Security	Network Acceleration and Security Function	<ul style="list-style-type: none"> <li>• Configurable packet processor</li> <li>• HW offload for networking</li> <li>• Acceleration engines for storage, networking and security</li> <li>• Public Key Processor (RSA/DH/ECC)</li> <li>• Secure Storage</li> <li>• Secure boot</li> </ul>
	TPM	N/A
Networking	Ethernet IC	1 GbE PHY: Marvell 88E1512P
	Ethernet Port	2 x 10 GbE SFP+, 4 x 1GbE RJ-45 LAN ports
	Network Module Slot	N/A
Expansion Slot	PCIe Slot	1 x PCIe x16 slot (PCIe x2 signal)
	PCIe Mini Card Slot	N/A
	M.2	1 x M.2 B key (SATA & USB 3.2 Gen 1 (5Gb/s))
Storage	Storage	2 x 2.5" SATA HDD/SSD bay
	eMMC	32GB
	SD Card	N/A
External I/O	USB	2 x USB 3.2 Gen 1 (5Gb/s)
	Console	1 x RJ-45
Internal I/O	M.2	1 x M.2 B Key (3042/2260) (SATA and USB 3.2 Gen 1) Support SATA SSD and 4G LTE module.
	HDMI	N/A
	USB	2 x USB 2.0
Power and Mechanical	Power Switch	1 x Power switch
	Reset Button	1 x Reset button
	Power Input	100 V ~ 240 V
	Type/Watt	ATX Power 250W 90V~264V AC
	Processor Cooling	1 x Active CPU heatsink with fan
	System Cooling	2 x Cooling fans with smart fan
	Antenna Port	1 x Antenna port
Physical and Environmental	Storage Temperature	0 ~ 40°C
	Operating Temperature	0 ~ 40°C (32 ~ 104°F)
	Operating Humidity	5% ~ 90% non-condensing
	Dimensions (W x L x H) (mm)	430 x 320 x 44.2
	Weight	5kg
OS and Certifications	Certification	CE / FCC
	Operating System	Linux Ubuntu 16.04.04
Indicators	LCM	LCM, 2 buttons
	LED	1 x Power LED, 1 x Storage LED, 1 x Alert LED

**▶ /O Interface**

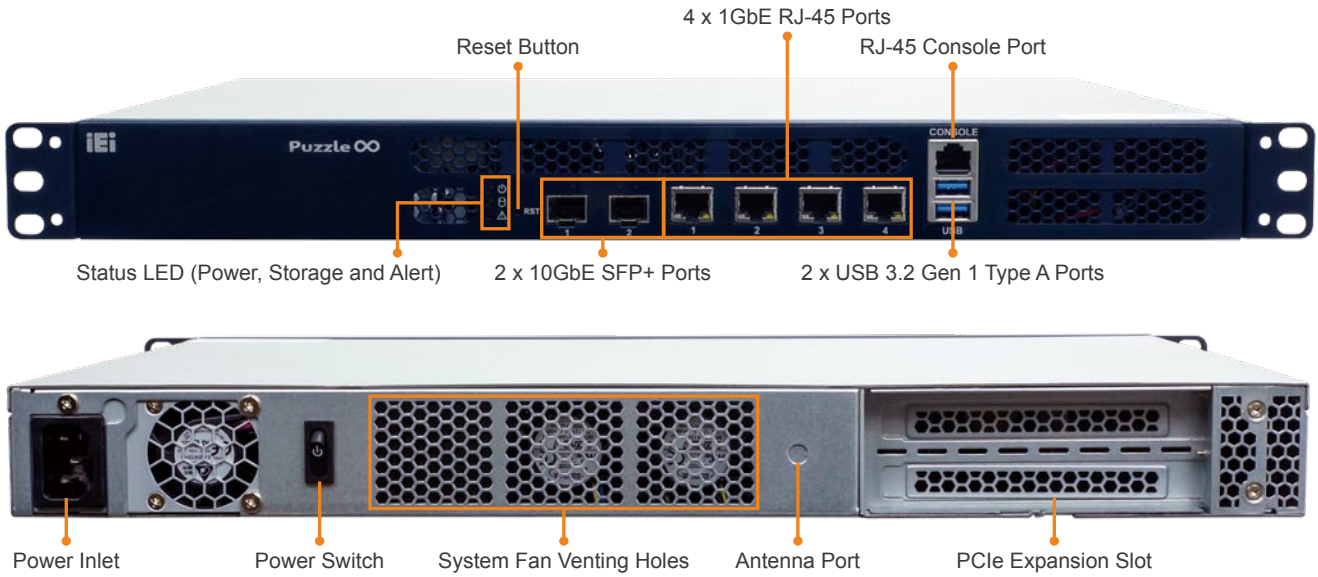

**▶ Dimensions (Unit: mm)**

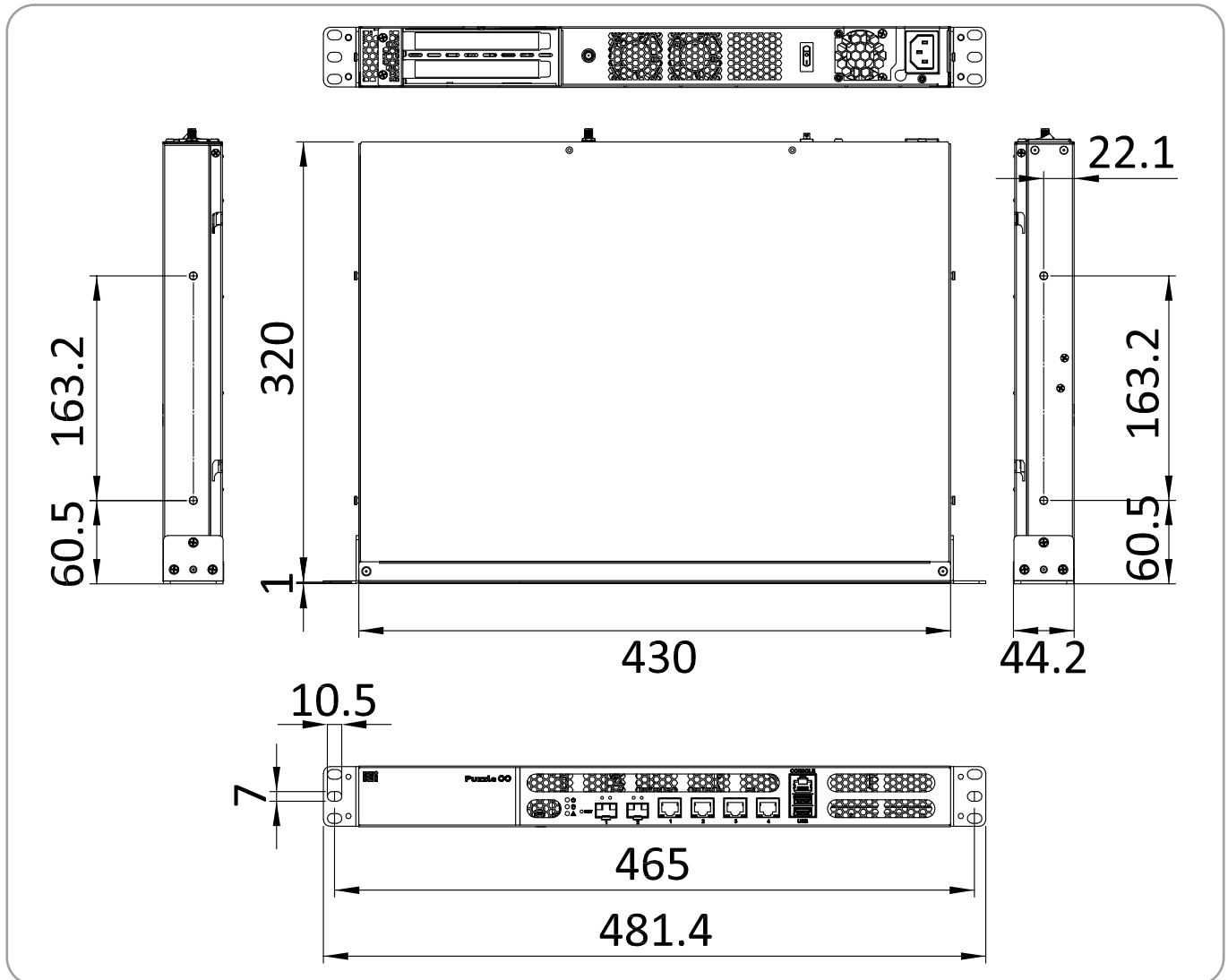

## ▶ Ordering Information

Part No.	Description
<b>PUZZLE-M801-A1-R10</b>	1U Rackmount Network Appliance with Marvell Armada 8040 processor, one DDR4 slot, four 1GbE, two 10GbE via SFP+, one PCIe expansion, RoHS
<b>PUZZLE-M801-A1/8G-R10</b>	1U Rackmount Network Appliance with Marvell Armada 8040 processor, 8GB DDR4, one 256GB SSD, four 1GbE, two 10GbE via SFP+, one PCIe expansion, RoHS

## ▶ Packing List

	PUZZLE-M801-A1	PUZZLE-M801-A1/8G
Power cord	1	1
Rack mounting ears	2	2
Screws for rack mounting ears	6	6
USB to console cable	Option	1
RS-232 to console cable	1	Option
Slide rail	Option	Option

## ▶ Options

Item	Part No.	Description
USB to console cable	32013-004000-100-RS	ROUND CABLE; LAN CABLE; FTDI Console Cable; 2; 1800MM; (A)USB A TYPE 4P MALE+PCB:FTDI_FT232RL; (B)RJ-45 8P8C; RoHS
RS-232 to console cable	32005-005100-100-RS	ROUND CABLE; RS-232/422/485; PUZZLE RS-232 Cable; 2; 500MM; 24AWG; (A)D-SUB 9P MALE+#4-40 Screw; (B)RJ-45 PLUG 8P8C; ONE PCS PKG; TC&C; RoHS

### Headquarters

威強電工業電腦 IEI Integration Corp.

No. 29, Zhongxing Rd., Xizhi Dist., New Taipei City 221, Taiwan  
 TEL : +886-2-86916798 / +886-2-26902098 FAX : +886-2-66160028  
 sales@ieiworld.com www.ieiworld.com

### America

IEI Technology USA Corp.

138 University Parkway, Pomona, CA 91768  
 TEL : +1-909-595-2819 FAX : +1-909-595-2816  
 sales@usa.ieiworld.com usa.ieiworld.com

### China

威強電工業電腦 IEI Integration (Shanghai) Corp.

上海市闵行莘庄工业区申富路515号  
 515, Shen Fu Rd., Xin Zhuang Industrial Develop Zone, Shanghai, 201108, China  
 TEL:+86-21-3116-7799 FAX:+86-21-3462-7797  
 sales@ieiworld.com.cn www.ieiworld.com.cn