

MODEL:
KINO-DH110

**Mini-ITX Motherboard Supports 6th/7th Gen. LGA1151
Intel® Core™ i7/i5/i3, Pentium® or Celeron® CPU,
Intel® H110 Chipset, DDR4, HDMI, DP++, iDP, Dual GbE, M.2,
USB 3.0, SATA 6Gb/s, RS-232/422/485, HD Audio and RoHS**

User Manual

Revision

Date	Version	Changes
May 21, 2018	1.00	Initial release

Copyright

COPYRIGHT NOTICE

The information in this document is subject to change without prior notice in order to improve reliability, design and function and does not represent a commitment on the part of the manufacturer.

In no event will the manufacturer be liable for direct, indirect, special, incidental, or consequential damages arising out of the use or inability to use the product or documentation, even if advised of the possibility of such damages.

This document contains proprietary information protected by copyright. All rights are reserved. No part of this manual may be reproduced by any mechanical, electronic, or other means in any form without prior written permission of the manufacturer.

TRADEMARKS

All registered trademarks and product names mentioned herein are used for identification purposes only and may be trademarks and/or registered trademarks of their respective owners.

Manual Conventions

**WARNING**

Warnings appear where overlooked details may cause damage to the equipment or result in personal injury. Warnings should be taken seriously.

**CAUTION**

Cautionary messages should be heeded to help reduce the chance of losing data or damaging the product.

**NOTE**

These messages inform the reader of essential but non-critical information. These messages should be read carefully as any directions or instructions contained therein can help avoid making mistakes.

Table of Contents

1 INTRODUCTION.....	1
1.1 INTRODUCTION.....	2
1.2 FEATURES.....	3
1.3 CONNECTORS	4
1.4 DIMENSIONS.....	5
1.5 DATA FLOW	6
1.6 TECHNICAL SPECIFICATIONS	7
2 PACKING LIST.....	10
2.1 ANTI-STATIC PRECAUTIONS	11
2.2 UNPACKING PRECAUTIONS.....	11
2.3 PACKING LIST.....	12
2.4 OPTIONAL ITEMS	13
3 CONNECTORS	15
3.1 PERIPHERAL INTERFACE CONNECTORS.....	16
3.1.1 KINO-DH110 Layout.....	16
3.1.1 Peripheral Interface Connectors	18
3.1.2 External Interface Panel Connectors.....	19
3.2 INTERNAL PERIPHERAL CONNECTORS	20
3.2.1 Audio Connector	20
3.2.2 Battery Connector.....	21
3.2.1 Buzzer Connector.....	22
3.2.2 Chassis Intrusion Connector.....	23
3.2.3 DDR4 SO-DIMM Sockets	24
3.2.4 Digital I/O Connector.....	25
3.2.5 EC Debug Connector.....	26
3.2.6 Fan Connector (CPU).....	27
3.2.7 Fan Connector (System)	28
3.2.8 Front Panel Connector	29

3.2.9	<i>PC Connector</i>	30
3.2.10	<i>Internal DisplayPort Connector</i>	31
3.2.1	<i>Internal Power Connector</i>	32
3.2.2	<i>Keyboard and Mouse Connector</i>	33
3.2.3	<i>LAN LED Connectors</i>	34
3.2.1	<i>M.2 Slot</i>	35
3.2.2	<i>PCIe x16 Slot</i>	35
3.2.3	<i>PCIe Mini Slot</i>	36
3.2.4	<i>RS-232 Serial Port Connectors</i>	38
3.2.5	<i>SATA 6Gb/s Drive Connectors</i>	39
3.2.1	<i>SATA Power Connectors</i>	40
3.2.2	<i>SMBus Connector</i>	41
3.2.3	<i>SPI Flash Connector</i>	42
3.2.4	<i>SPI Flash Connector, EC</i>	43
3.2.5	<i>USB 2.0 Connectors</i>	44
3.3	EXTERNAL PERIPHERAL INTERFACE CONNECTOR PANEL	45
3.3.1	<i>Audio Connector</i>	45
3.3.2	<i>Ethernet and USB 3.0 Connectors</i>	46
3.3.1	<i>RS-232/422/485 Serial Port Connectors</i>	47
3.3.1	<i>HDMI and DP++ Connector</i>	48
3.3.1	<i>Power Connector (Power Adapter)</i>	49
4	INSTALLATION	50
4.1	<i>ANTI-STATIC PRECAUTIONS</i>	51
4.2	<i>INSTALLATION CONSIDERATIONS</i>	51
4.3	<i>SOCKET LGA1151 CPU INSTALLATION</i>	53
4.4	<i>SOCKET LGA1151 COOLING KIT INSTALLATION</i>	56
4.5	<i>SO-DIMM INSTALLATION</i>	58
4.6	<i>FULL-SIZE PCIe MINI CARD INSTALLATION</i>	59
4.7	<i>M.2 MODULE INSTALLATION</i>	61
4.8	<i>SYSTEM CONFIGURATION</i>	62
4.8.1	<i>AT/ATX Power Mode Setting</i>	62
4.8.2	<i>Clear CMOS Button</i>	62
4.8.3	<i>Flash Descriptor Security Override Jumper</i>	63
4.8.4	<i>USB Power Selection</i>	64

KINO-DH110 Mini-ITX Motherboard

4.9 INTERNAL PERIPHERAL DEVICE CONNECTIONS	65
4.9.1 SATA Drive Connection	65
4.10 ADDING USB 3.0 DRIVERS TO A WINDOWS 7 INSTALLATION IMAGE	68
4.11 AVAILABLE DRIVERS	66
4.11.1 Driver Download.....	67
5 BIOS	72
5.1 INTRODUCTION.....	73
5.1.1 Starting Setup.....	73
5.1.2 Using Setup	73
5.1.3 Getting Help.....	74
5.1.4 Unable to Reboot after Configuration Changes	74
5.1.5 BIOS Menu Bar.....	74
5.2 MAIN.....	75
5.3 ADVANCED	76
5.3.1 CPU Configuration	77
5.3.2 PCH-FW Configuration.....	79
5.3.3 ACPI Settings	80
5.3.4 F81866 Super IO Configuration	81
5.3.4.1 Serial Port n Configuration	82
5.3.4.2 Serial Port 1 Configuration	82
5.3.4.3 Serial Port 3 Configuration	83
5.3.4.4 Serial Port 4 Configuration	84
5.3.5 iWDD H/W Monitor.....	85
5.3.5.1 Smart Fan Mode Configuration	86
5.3.6 RTC Wake Settings	87
5.3.7 Serial Port Console Redirection	88
5.3.7.1 Legacy Console Redirection Settings	91
5.3.8 NVMe Configuration.....	92
5.3.9 USB Configuration.....	93
5.3.10 iEi Feature	94
5.4 CHIPSET	95
5.4.1 System Agent (SA) Configuration	96
5.4.1.1 Memory Configuration	97
5.4.1.2 Graphics Configuration.....	97

5.4.1.3 PEG Port Configuration.....	99
5.4.2 PCH-IO Configuration	101
5.4.2.1 PCI Express Configuration.....	103
5.4.2.2 SATA Configuration.....	105
5.4.2.3 HD Audio Configuration.....	106
5.5 SECURITY.....	107
5.6 BOOT.....	108
5.7 SAVE & EXIT	110
A REGULATORY COMPLIANCE	111
B PRODUCT DISPOSAL	113
C BIOS OPTIONS	115
D DIGITAL I/O INTERFACE.....	118
D.1 INTRODUCTION.....	119
D.2 ASSEMBLY LANGUAGE SAMPLE 1.....	120
D.3 ASSEMBLY LANGUAGE SAMPLE 2.....	120
E WATCHDOG TIMER.....	121
F HAZARDOUS MATERIALS DISCLOSURE.....	124

List of Figures

Figure 1-1: KINO-DH110.....	2
Figure 1-2: Connectors	4
Figure 1-3: KINO-DH110 Dimensions (mm)	5
Figure 1-4: Data Flow Diagram.....	6
Figure 3-1: Peripheral Interface Connectors (Front Side)	16
Figure 3-2: Peripheral Interface Connectors (Solder Side).....	17
Figure 3-3: Audio Connector Location	20
Figure 3-4: Battery Connector Location.....	21
Figure 3-5: Buzzer Connector Location	22
Figure 3-6: Chassis Intrusion Connector Location.....	23
Figure 3-7: DDR4 SO-DIMM Socket Locations	24
Figure 3-8: Digital I/O Connector Location	25
Figure 3-9: EC Debug Connector Location	26
Figure 3-10: CPU Fan Connector Location	27
Figure 3-11: System Fan Connector Location.....	28
Figure 3-12: Front Panel Connector Location	29
Figure 3-13: I ² C Connector Location	30
Figure 3-14: Internal DisplayPort Connector Location	31
Figure 3-15: Internal Power Connector Pinout Location	32
Figure 3-16: Keyboard and Mouse Connector Location.....	33
Figure 3-17: LAN LED Connector Locations	34
Figure 3-18: M.2 Slot Location	35
Figure 3-19: PCIe x16 Slot Location	36
Figure 3-20: PCIe Mini Slot Location	36
Figure 3-21: RS-232 Serial Port Connector Locations.....	38
Figure 3-22: SATA 6Gb/s Drive Connector Locations	39
Figure 3-23: SATA Power Connector Locations	40
Figure 3-24: SMBus Connector Location	41
Figure 3-25: SPI Flash Connector Location.....	42
Figure 3-26: SPI EC Flash Connector Location.....	43

Figure 3-27: USB 2.0 Connector Locations	44
Figure 3-28: External Peripheral Interface Connector	45
Figure 3-29: Audio Connector	45
Figure 3-30: LAN Connector	47
Figure 3-31: HDMI Connector	48
Figure 3-32: HDMI Connector	49
Figure 3-33: 4-pin Power Mini-DIN Connector	49
Figure 4-1: Disengage the CPU Socket Load Lever	53
Figure 4-2: Remove Protective Cover	54
Figure 4-3: Insert the Socket LGA1151 CPU	55
Figure 4-4: Close the Socket LGA1151	55
Figure 4-5: Cooling Kit Support Bracket	57
Figure 4-6: SO-DIMM Installation (DDR4)	58
Figure 4-7: Removing the Retention Screw	59
Figure 4-8: Inserting the Full-size PCIe Mini Card into the Slot at an Angle	60
Figure 4-9: Securing the Full-size PCIe Mini Card	60
Figure 4-10: Inserting the M.2 Module into the Slot at an Angle	61
Figure 4-11: Securing the M.2 Module	61
Figure 4-12: AT/ATX Power Mode Switch Location	62
Figure 4-13: Clear CMOS Button Location	63
Figure 4-14: Flash Descriptor Security Override Jumper Location	63
Figure 4-15: SATA Drive Cable Connection	65
Figure 4-16: IEI Resource Download Center	66
Figure 4-17: Windows 7 USB 3.0 Creator Utility	69
Figure 4-18: Update Process is Complete	70

List of Tables

Table 1-1: KINO-DH110 Specifications	9
Table 2-1: Packing List.....	12
Table 2-2: Optional Items	14
Table 3-1: Peripheral Interface Connectors	19
Table 3-2: External Peripheral Connectors	19
Table 3-3: Audio Connector Pinouts	20
Table 3-4: Battery Connector Pinouts	22
Table 3-5: Buzzer Connector Pinouts.....	22
Table 3-6: Chassis Intrusion Connector Pinouts	23
Table 3-7: Digital I/O Connector Pinouts.....	25
Table 3-8: EC Debug Connector Pinouts	26
Table 3-9: CPU Fan Connector Pinouts.....	27
Table 3-10: System Fan Connector Pinouts	28
Table 3-11: Front Panel Connector Pinouts.....	29
Table 3-12: I ² C Connector Pinouts.....	30
Table 3-13: Internal DisplayPort Connector Pinouts	31
Table 3-14: Internal Power Connector Pinouts.....	32
Table 3-15: Keyboard and Mouse Connector Pinouts	33
Table 3-16: LAN LED Connector Pinouts	34
Table 3-17: PCIe Mini Slot Pinouts.....	37
Table 3-18: RS-232 Serial Port Connector Pinouts	38
Table 3-19: SATA 6Gb/s Drive Connector Pinouts.....	39
Table 3-20: SATA Power Connector Pinouts.....	40
Table 3-21: SMBus Connector Pinouts	41
Table 3-22: SPI Flash Connector Pinouts	42
Table 3-23: SPI EC Flash Connector Pinouts	43
Table 3-24: USB 2.0 Connector Pinouts.....	44
Table 3-25: USB 3.0 Port Pinouts.....	46
Table 3-26: LAN Pinouts	46
Table 3-27: DB-9 RS-232/422/485 Pinouts	47

Table 3-28: HDMI Connector Pinouts	48
Table 3-29: DP++ Connector Pinouts	49
Table 4-1: AT/ATX Power Mode Switch Settings.....	62
Table 4-2: Flash Descriptor Security Override Jumper Settings.....	63
Table 4-3: BIOS Options and Configured USB Ports.....	64
Table 4-4: USB Power Source Setup	64
Table 5-1: BIOS Navigation Keys	74
Table 5-2: BIOS Options and Configured USB Ports.....	103

BIOS Menus

BIOS Menu 1: Main	75
BIOS Menu 2: Advanced	76
BIOS Menu 3: CPU Configuration	77
BIOS Menu 4: PCH-FW Configuration	79
BIOS Menu 5: ACPI Configuration	80
BIOS Menu 6: F81866 Super IO Configuration	81
BIOS Menu 7: Serial Port n Configuration Menu	82
BIOS Menu 8: iWDD H/W Monitor	85
BIOS Menu 9: Smart Fan Mode Configuration	86
BIOS Menu 10: RTC Wake Settings	87
BIOS Menu 11: Serial Port Console Redirection	88
BIOS Menu 12: Legacy Console Redirection Settings	91
BIOS Menu 13: NVMe Configuration.....	92
BIOS Menu 14: USB Configuration	93
BIOS Menu 15: iEi Feature	94
BIOS Menu 16: Chipset	95
BIOS Menu 17: System Agent (SA) Configuration	96
BIOS Menu 18: Memory Configuration.....	97
BIOS Menu 19: Graphics Configuration.....	97
BIOS Menu 20: PEG Port Configuration.....	99
BIOS Menu 21: PEG Port Feature Configuration.....	100
BIOS Menu 22: PCH-IO Configuration	101
BIOS Menu 23: PCI Express Configuration	103
BIOS Menu 24: MPCIE1 Slot	104
BIOS Menu 25: SATA Configuration	105
BIOS Menu 26: HD Audio Configuration	106
BIOS Menu 27: Security	107
BIOS Menu 28: Boot	108
BIOS Menu 29: Save & Exit.....	110

Chapter

1

Introduction

1.1 Introduction



Figure 1-1: KINO-DH110

The KINO-DH110 is a Mini-ITX motherboard. It accepts a Socket LGA1151 Intel® Core™ i7/i5/i3, Pentium® or Celeron® processor and supports two 260-pin 2133 MHz dual-channel DDR4 SO-DIMM modules for up to 32 GB of memory.

The KINO-DH110 provides two GbE interfaces through the Intel® PCIe Ethernet controllers. The integrated Intel® H110 chipset supports two SATA 6Gb/s drives and one M2. B-key slot for storage. In addition, the KINO-DH110 includes HDMI, DP++ and iDP interfaces for dual independent display.

Expansion and I/O include one PCIe x16 slot, one PCIe Mini slot, four USB 3.0 on the rear panel, four USB 2.0 by pin headers, two RS-232 and one RS-232/422/485. High Definition Audio (HDA) support ensures HDA devices can be easily implemented on the KINO-DH110.

KINO-DH110 Mini-ITX Motherboard

1.2 Features

Some of the KINO-DH110 motherboard features are listed below:

- Mini-ITX form factor
- 6th/7th generation LGA1151 Intel® Core™ i7/i5/i3, Pentium® or Celeron® processor supported
- Intel® H110 chipset
- Two 260-pin 2133 MHz dual-channel unbuffered DDR4 SO-DIMMs supported (system max. 32 GB)
- Two GbE connectors via Intel® I219LM and Intel® I211 PCIe controllers
- Dual independent display by HDMI, DP++ and iDP interfaces
- Two SATA 6Gb/s connectors
- One M.2 2242 B-key slot for SATA storage module installation
- One PCIe x16 slot
- One full-size PCIe Mini slot
- Four USB 3.0 ports on the rear I/O
- Four USB 2.0 ports via internal pin headers
- Two RS-232 serial ports via internal pin headers
- One RS-232/422/485 serial port on the rear I/O
- High Definition Audio
- RoHS compliant

1.3 Connectors

The connectors on the KINO-DH110 are shown in the figure below.

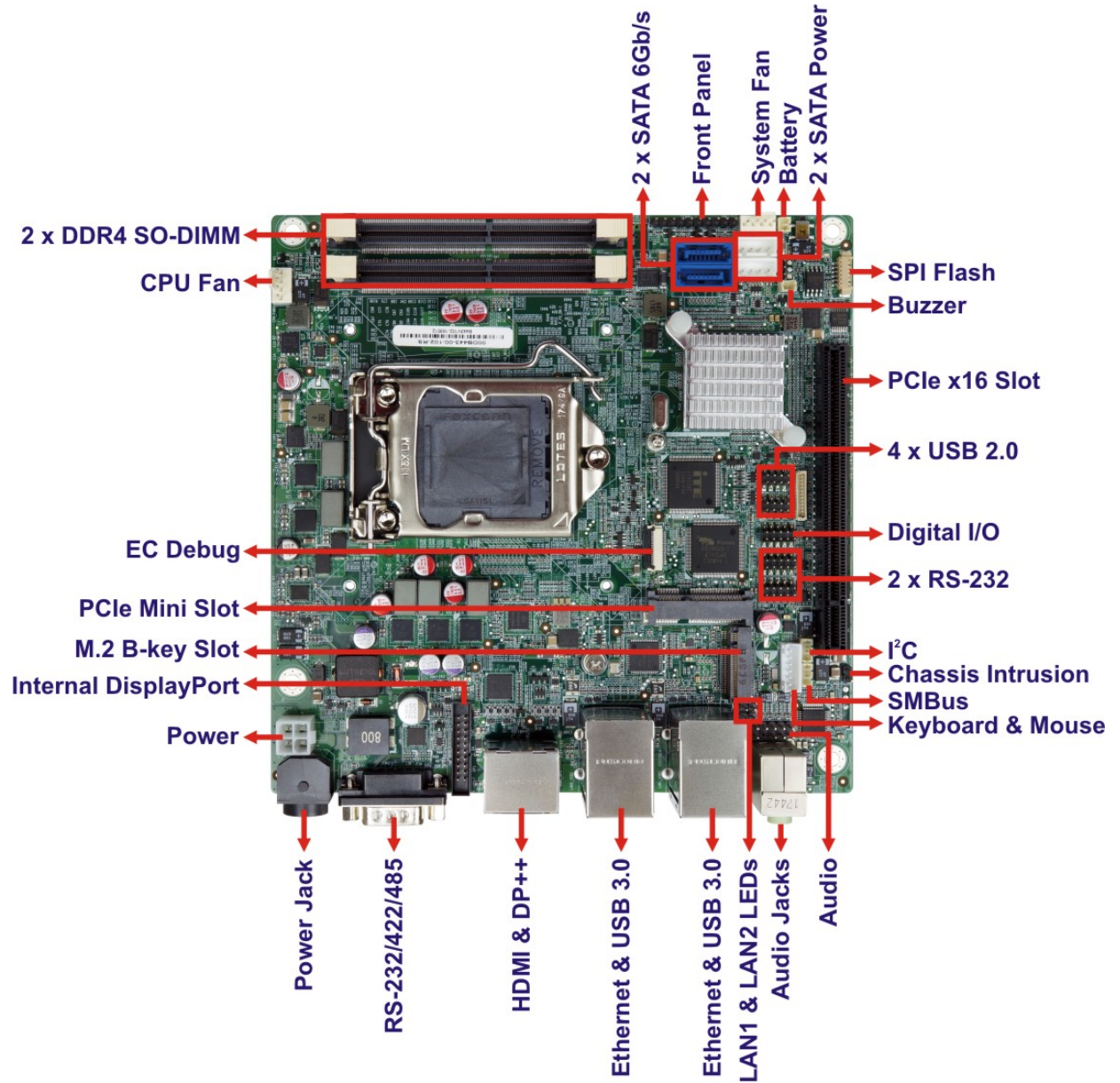

Figure 1-2: Connectors

KINO-DH110 Mini-ITX Motherboard

1.4 Dimensions

The main dimensions of the KINO-DH110 are shown in the diagram below.

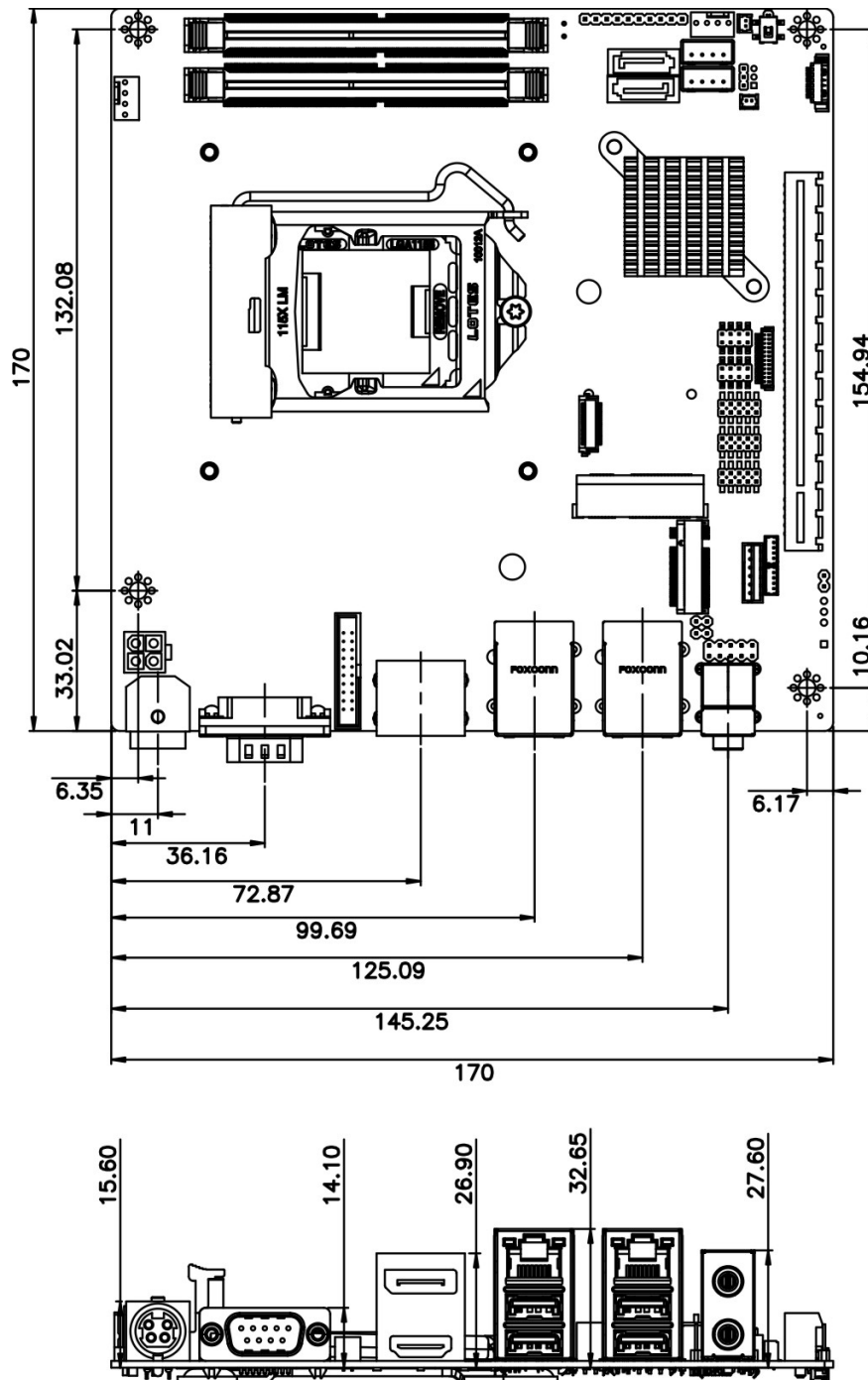

Figure 1-3: KINO-DH110 Dimensions (mm)

1.5 Data Flow

Figure 1-4 shows the data flow between the system chipset, the CPU and other components installed on the motherboard.

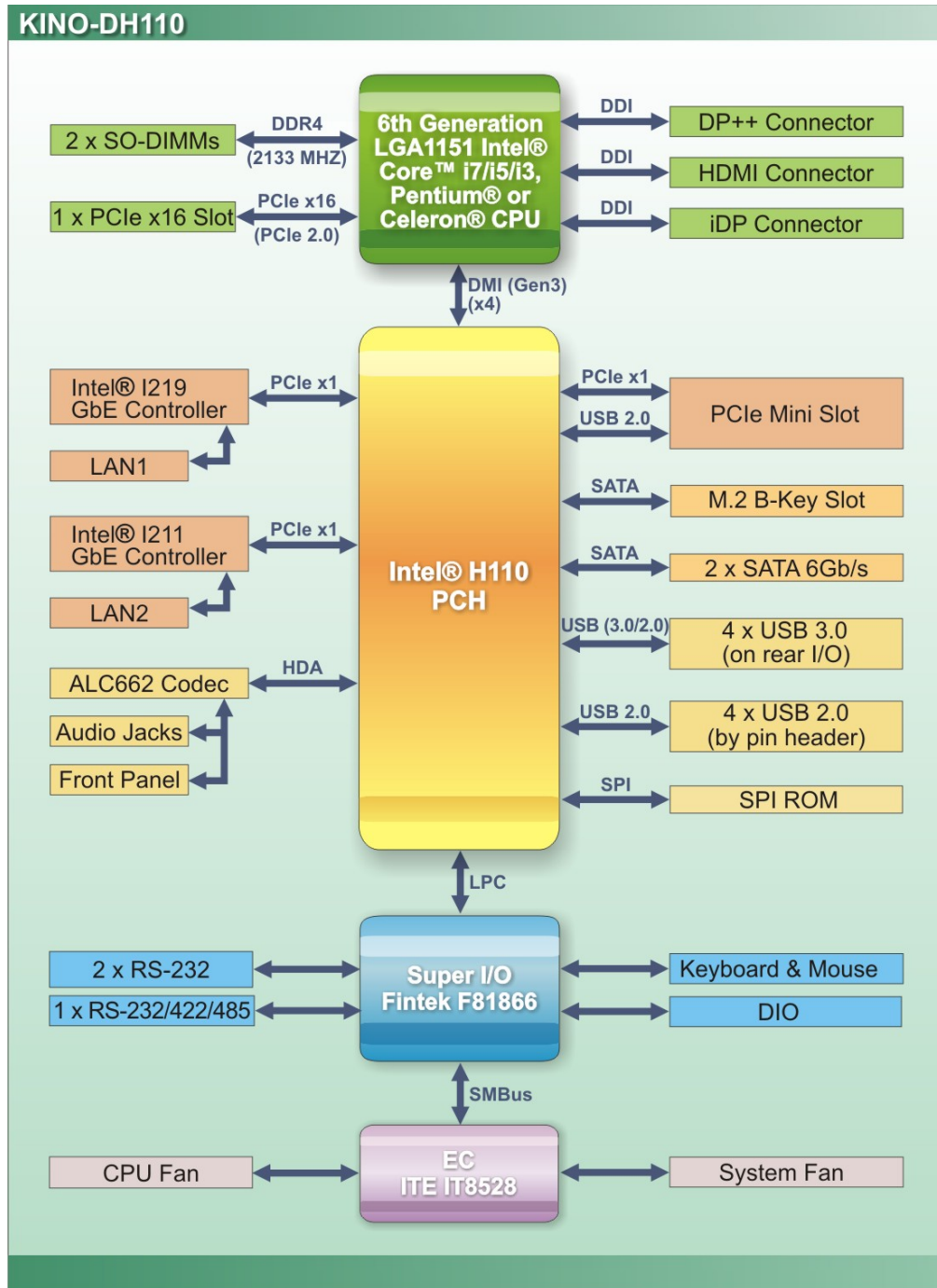

Figure 1-4: Data Flow Diagram

KINO-DH110 Mini-ITX Motherboard

1.6 Technical Specifications

The KINO-DH110 technical specifications are listed below.

Specification/Model	KINO-DH110
Form Factor	Mini-ITX
CPU Supported	6 th /7 th generation LGA1151 Intel® Core™ i7/i5/i3, Pentium® or Celeron® CPU
PCH	Intel® H110
Memory	Two 260-pin 2133 MHz dual-channel unbuffered DDR4 SDRAM SO-DIMMs supported (system max. 32 GB)
Graphics Engine	Intel® HD Graphics Gen9 engine with 16 low-power execution units, supporting DX2015, OpenGL 5.x, OpenCL 2.x and ES 2.0
Display Output	Supports dual independent display One HDMI (up to 3840x2160@60Hz) One DP++ (up to 3840x2160@60Hz) One iDP interface for HDMI, LVDS, VGA, DVI and DisplayPort (up to 3840x2160@60Hz)
Ethernet Controllers	LAN1: Intel® I219LM PCIe controller with Intel® AMT 11.0 support LAN2: Intel® I211 PCIe controller
Audio	Realtek ALC662 HD Audio codec
BIOS	UEFI BIOS
Super I/O Controller	Fintek F81866
Watchdog Timer	Software programmable supports 1~255 sec. system reset
Expansions	One PCIe x16 slot (Gen 2) One full-size PCIe Mini card slot (PCIe and USB signal) One M.2 2242 slot (B-key, SATA signal)

I/O Interface Connectors	
Audio Connectors	Line-out and mic-in audio jacks on rear panel One internal front panel audio connector (10-pin header)
Chassis Intrusion	One 2-pin header
Digital I/O	8-bit digital I/O
Ethernet	Two RJ-45 GbE ports
Fan	One 4-pin CPU smart fan connector One 4-pin system smart fan connector
Front Panel	One 10-pin header (power LED, HDD LED, speaker, power button, reset button)
I²C	One 4-pin wafer connector
Internal DisplayPort	One 20-pin box header
Keyboard and Mouse	One internal keyboard and mouse connector (6-pin wafer)
LAN LED	Two 2-pin headers for LAN1 LED and LAN2 LED
Serial ATA	Two SATA 6Gb/s connectors
Serial Ports	Two RS-232 via internal 10-pin headers One RS-232/422/485 on rear panel
SMBus	One 4-pin wafer connector
USB 2.0	Four USB 2.0 ports via internal pin headers
USB 3.0	Four USB 3.0 ports on rear panel * The Windows® 7 installation media does not include native driver support for USB 3.0. In order to use the USB keyboard or mouse connected to a USB 3.0 port during OS installation, the user has to update the Windows® 7 installation image so that it contains USB 3.0 drivers. Please refer to Section 4.11 for detailed installation procedures.

KINO-DH110 Mini-ITX Motherboard

Environmental and Power Specifications	
Power Supply	9 V ~ 28 V DC input One external DC jack (4-pin DIN) One internal power connector (4-pin header) AT/ATX power support
Power Consumption	12V@12.16A (3.4 GHz Intel® Core™ i7-6700 CPU with two 16 GB 2133 MHz DDR4 memory)
Operating Temperature	-20°C ~ 60°C
Storage Temperature	-30°C ~ 70°C
Operating Humidity	5% ~ 95% (non-condensing)
Safety	CE, FCC
Physical Specifications	
Dimensions	170 mm x 170 mm
Weight (GW/NW)	900 g / 400 g

Table 1-1: KINO-DH110 Specifications

Chapter

2

Packing List

KINO-DH110 Mini-ITX Motherboard

2.1 Anti-static Precautions



WARNING!

Static electricity can destroy certain electronics. Make sure to follow the ESD precautions to prevent damage to the product, and injury to the user.

Make sure to adhere to the following guidelines:

- **Wear an anti-static wristband:** Wearing an anti-static wristband can prevent electrostatic discharge.
- **Self-grounding:** Touch a grounded conductor every few minutes to discharge any excess static buildup.
- **Use an anti-static pad:** When configuring any circuit board, place it on an anti-static mat.
- **Only handle the edges of the PCB:** Don't touch the surface of the motherboard. Hold the motherboard by the edges when handling.

2.2 Unpacking Precautions

When the KINO-DH110 is unpacked, please do the following:

- Follow the anti-static guidelines above.
- Make sure the packing box is facing upwards when opening.
- Make sure all the packing list items are present.

2.3 Packing List



NOTE:

If any of the components listed in the checklist below are missing, do not proceed with the installation. Contact the IEI reseller or vendor the KINO-DH110 was purchased from or contact an IEI sales representative directly by sending an email to sales@ieiworld.com.

The KINO-DH110 is shipped with the following components:









Quantity	Item and Part Number	Image
1	KINO-DH110 single board computer	
1	SATA and power cable	
1	I/O shielding	
1	Quick installation guide	

Table 2-1: Packing List

KINO-DH110 Mini-ITX Motherboard

2.4 Optional Items

The following are optional components which may be separately purchased:

Item and Part Number	Image
Dual USB cable (wo bracket) (P/N: 32000-070301-RS)	
RS-232 cable (P/N: 32200-000049-RS)	
LGA1155/LGA1156 cooler kit (1U chassis compatible, 45W) (P/N: CF-1156C-R20)	
LGA1155/LGA1156 cooler kit (1U chassis compatible, 65W) (P/N: CF-1156D-R20)	
High-performance LGA1155/LGA1156 cooler kit (95W) (P/N: CF-115XE-R10)	
DisplayPort to DisplayPort converter board (for IEI iDP connector) (P/N: DP-DP-R10)	
DisplayPort to DVI-D converter board (for IEI iDP connector) (P/N: DP-DVI-R10)	



Item and Part Number	Image
DisplayPort to HDMI converter board (for IEI iDP connector) (P/N: DP-HDMI-R10)	
DisplayPort to LVDS converter board (for IEI iDP connector) (P/N: DP-LVDS-R10)	
DisplayPort to VGA converter board (for IEI iDP connector) (P/N: DP-VGA-R10)	

Table 2-2: Optional Items

Chapter

3

Connectors

3.1 Peripheral Interface Connectors

This chapter details all the peripheral interface connectors.

3.1.1 KINO-DH110 Layout

The figure below shows all the peripheral interface connectors.

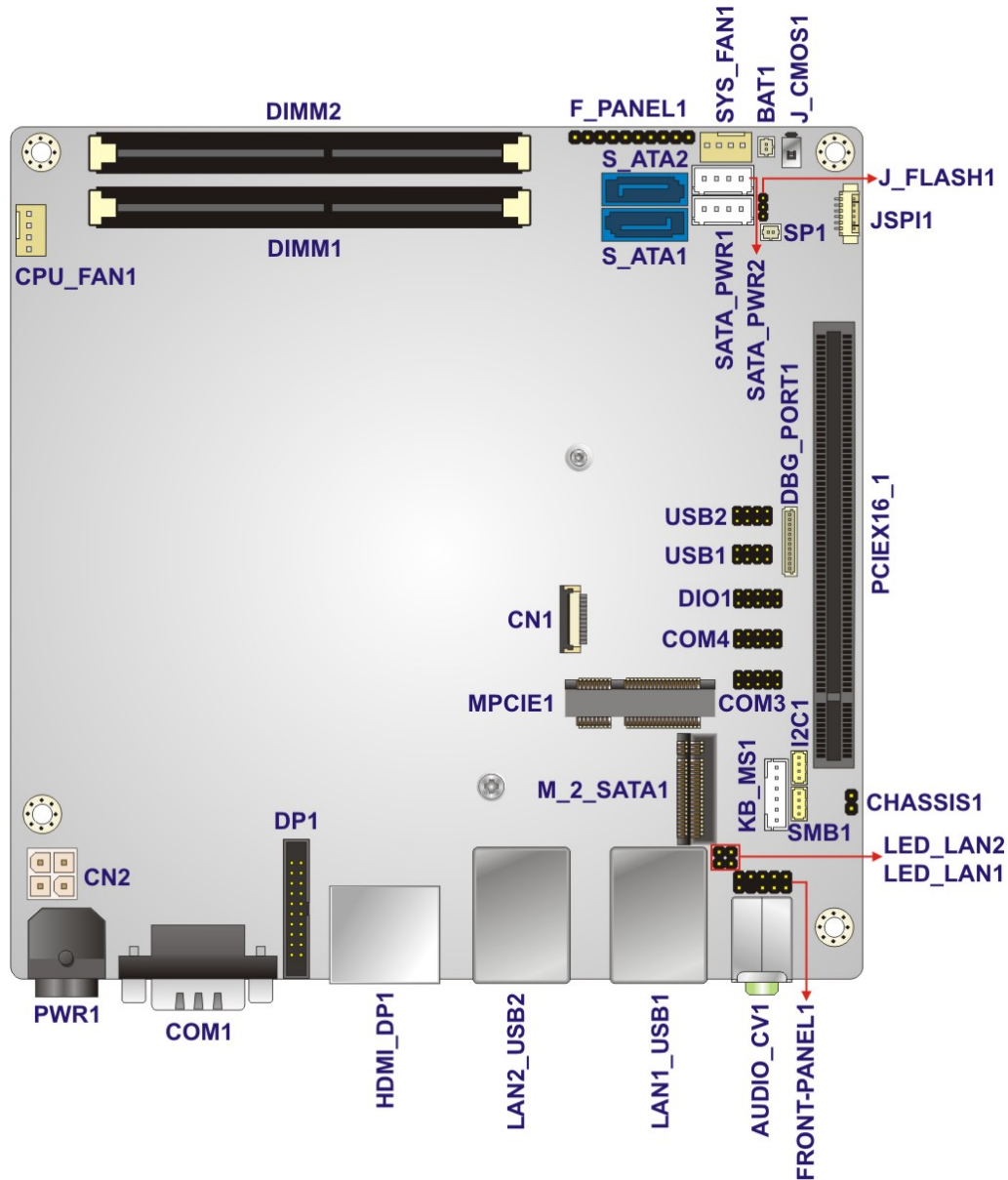

Figure 3-1: Peripheral Interface Connectors (Front Side)

KINO-DH110 Mini-ITX Motherboard

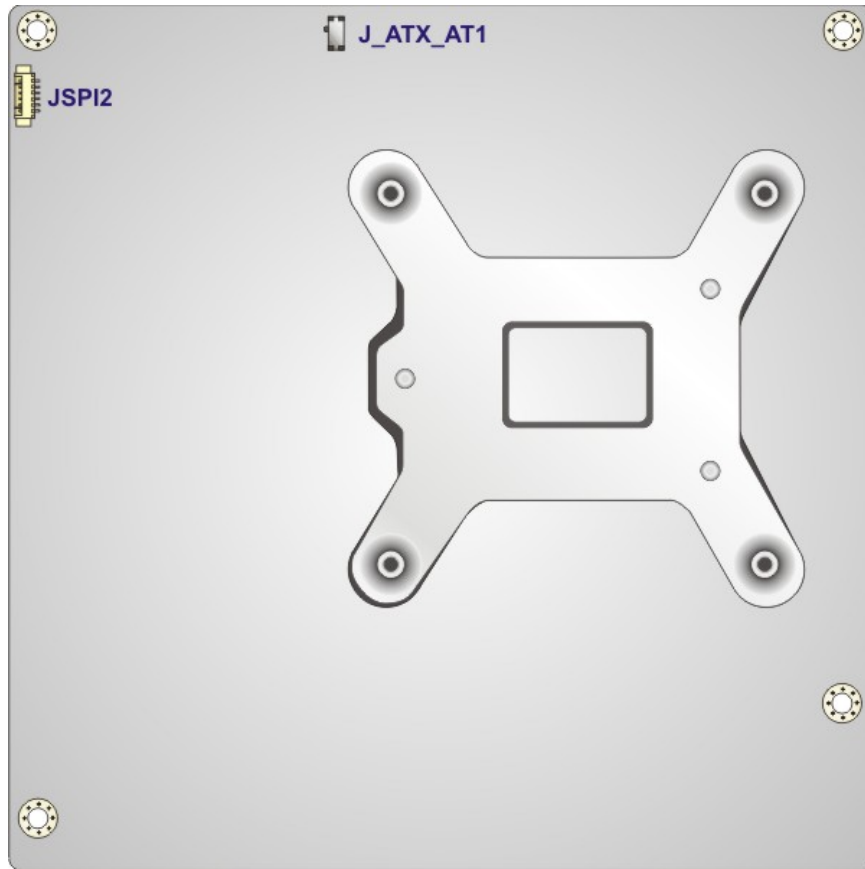

Figure 3-2: Peripheral Interface Connectors (Solder Side)

3.1.1 Peripheral Interface Connectors

The table below lists all the connectors on the board.

Connector	Type	Label
Audio connector	10-pin header	FRONT-PANEL1
Battery connector	2-pin wafer	BAT1
Buzzer connector	2-pin wafer	SP1
Chassis intrusion connector	2-pin header	CHASSIS1
DDR4 SO-DIMM sockets	260-pin DDR4 SO-DIMM socket	DIMM1, DIMM2
Digital I/O connector	10-pin header	DIO1
Debug connector	12-pin wafer	DBG_PORT1
EC debug connector	20-pin FPC	CN1
Fan connector (CPU)	4-pin wafer	CPU_FAN1
Fan connector (system)	4-pin wafer	SYS_FAN1
Front panel connector	10-pin header	F_PANEL1
I2C connector	4-pin wafer	I2C1
Internal DisplayPort connector	20-pin box header	DP1
Internal power connector	4-pin Molex	CN2
Keyboard and mouse connector	6-pin wafer	KB_MS1
LAN LED connectors	2-pin header	LED_LAN1, LED_LAN2
M.2 slot	M.2 B-key slot	M_2_SATA1
PCIe x16 slot	PCIe x16 slot	PCIEX16_1
PCIe Mini slot	PCIe Mini slot	MPCIE1
RS-232 serial ports	10-pin header	COM3, COM4
SATA 6Gb/s drive connector	7-pin SATA connector	S_ATA1, S_ATA2

KINO-DH110 Mini-ITX Motherboard

Connector	Type	Label
SATA power connectors	4-pin wafer	SATA_PWR1, SATA_PWR2
SMBus connector	4-pin wafer	SMB1
SPI flash connector	6-pin wafer	JSPI1
SPI flash connector, EC	6-pin wafer	JSPI2
USB 2.0 connectors	8-pin header	USB1, USB2

Table 3-1: Peripheral Interface Connectors

3.1.2 External Interface Panel Connectors

The table below lists the connectors on the external I/O panel.

Connector	Type	Label
Audio connector	Audio jacks	AUDIO_CV1
Ethernet and USB 3.0 ports	RJ-45, USB 3.0	LAN1_USB1, LAN2_USB2
HDMI and DP++ connectors	HDMI, DP++	HDMI_DP1
Power jack	4-pin DIN	PWR1
RS-232/422/485 serial port	DB-9 male	COM1

Table 3-2: External Peripheral Connectors

3.2 Internal Peripheral Connectors

The section describes all of the connectors on the KINO-DH110.

3.2.1 Audio Connector

- CN Label:** FRONT-PANEL1
- CN Type:** 10-pin header, p=2.54 mm
- CN Location:** See **Figure 3-3**
- CN Pinouts:** See **Table 3-3**

This connector connects to speakers, a microphone and an audio input.

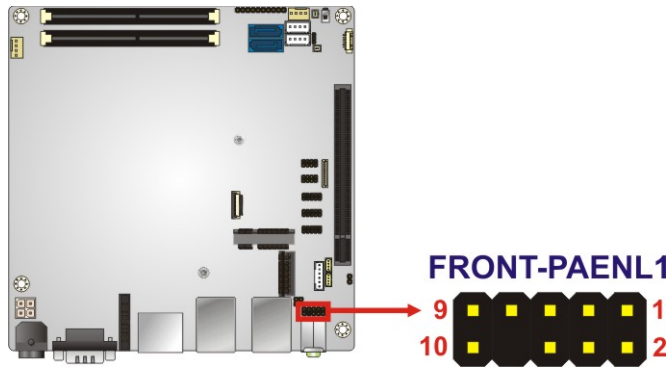

Figure 3-3: Audio Connector Location

Pin	Description	Pin	Description
1	MIC2-L	2	GND
3	MIC2-R	4	PRESENCE#
5	LINE2-R	6	MIC2-JD
7	FRONT-IO	8	NC
9	LINE2-L	10	LINE2-JD

Table 3-3: Audio Connector Pinouts

KINO-DH110 Mini-ITX Motherboard

3.2.2 Battery Connector



CAUTION:

Risk of explosion if battery is replaced by an incorrect type. Only certified engineers should replace the on-board battery.

Dispose of used batteries according to instructions and local regulations.



NOTE:

It is recommended to attach the RTC battery onto the system chassis in which the KINO-DH110 is installed.

CN Label:	BAT1
CN Type:	2-pin wafer, p=1.25 mm
CN Location:	See Figure 3-4
CN Pinouts:	See Table 3-4

A system battery is placed in the battery holder. The battery provides power to the system clock to retain the time when power is turned off.

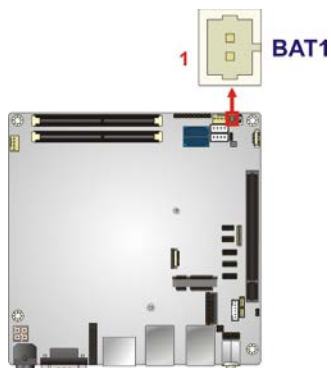

Figure 3-4: Battery Connector Location

Pin	Description
1	Battery+
2	Ground

Table 3-4: Battery Connector Pinouts

3.2.1 Buzzer Connector



NOTE:

If you cannot find a good place to put a buzzer on the KINO-DH110, it is recommended to attach the buzzer onto the system chassis in which the KINO-DH110 is installed.

- CN Label:** SP1
- CN Type:** 2-pin wafer, p=1.25 mm
- CN Location:** See **Figure 3-5**
- CN Pinouts:** See **Table 3-5**

The buzzer connector is connected to a buzzer.

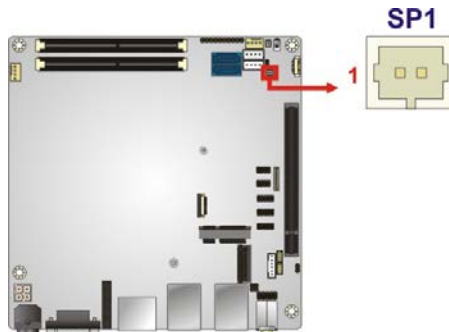

Figure 3-5: Buzzer Connector Location

Pin	Description
1	BU_PWR
2	PC_BEEP

Table 3-5: Buzzer Connector Pinouts

KINO-DH110 Mini-ITX Motherboard

3.2.2 Chassis Intrusion Connector

- CN Label:** CHASSIS1
- CN Type:** 2-pin header, p=2.54 mm
- CN Location:** See **Figure 3-6**
- CN Pinouts:** See **Table 3-6**

The chassis intrusion connector is for a chassis intrusion detection sensor or switch that detects if a chassis component is removed or replaced.

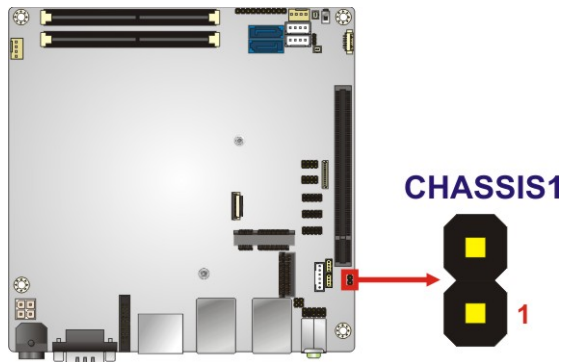

Figure 3-6: Chassis Intrusion Connector Location

Pin	Description
1	+3.3VSB
2	CHASSIS OPEN

Table 3-6: Chassis Intrusion Connector Pinouts

3.2.3 DDR4 SO-DIMM Sockets



CAUTION:

For dual channel configuration, always install two identical memory modules that feature the same capacity, timings, voltage, number of ranks and the same brand.

- CN Label:** DIMM1, DIMM2
- CN Type:** 260-pin DDR4 SO-DIMM socket
- CN Location:** See **Figure 3-7**

The SO-DIMM slots are for installing the DDR4 SO-DIMMs.

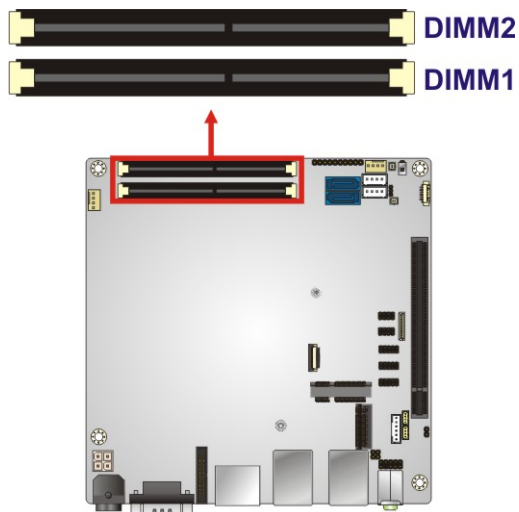

Figure 3-7: DDR4 SO-DIMM Socket Locations

KINO-DH110 Mini-ITX Motherboard

3.2.4 Digital I/O Connector

- CN Label:** DIO1
- CN Type:** 10-pin header, p=2.00 mm
- CN Location:** See **Figure 3-8**
- CN Pinouts:** See **Table 3-7**

The digital I/O connector provides programmable input and output for external devices.

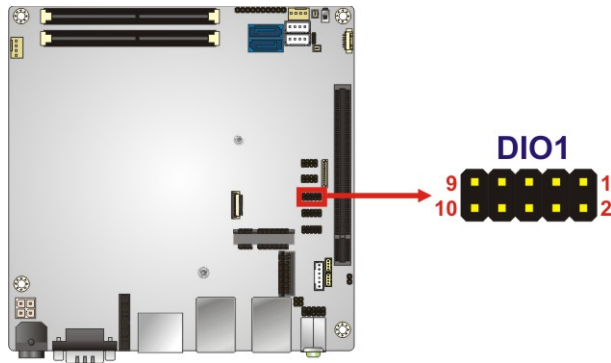

Figure 3-8: Digital I/O Connector Location

Pin	Description	Pin	Description
1	GND	2	VCC5V
3	Output 3	4	Output 2
5	Output 1	6	Output 0
7	Input 3	8	Input 2
9	Input 1	10	Input 0

Table 3-7: Digital I/O Connector Pinouts

3.2.5 EC Debug Connector

- CN Label:** CN1
- CN Type:** 20-pin FPC, p=0.5 mm
- CN Location:** See **Figure 3-9**
- CN Pinouts:** See **Table 3-8**

The EC debug connector is used for EC debug.

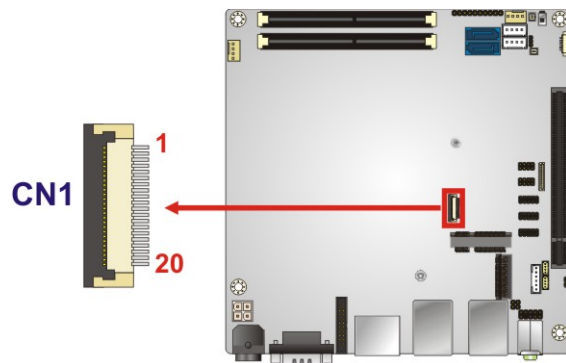

Figure 3-9: EC Debug Connector Location

Pin	Description	Pin	Description
1	EC_EPP_STB#	11	EC_EPP_BUSY
2	EC_EPP_PDO	12	EC_EPP_KSI5
3	EC_EPP_PD1	13	EC_EPP_KSI4
4	EC_EPP_PD2	14	EC_EPP_AFD#
5	EC_EPP_PD3	15	NC
6	EC_EPP_PD4	16	EC_EPP_INIT#
7	EC_EPP_PD5	17	EC_EPP_SLIN#
8	EC_EPP_PD6	18	GND
9	EC_EPP_PD7	19	GND
10	NC	20	GND

Table 3-8: EC Debug Connector Pinouts

KINO-DH110 Mini-ITX Motherboard

3.2.6 Fan Connector (CPU)

- CN Label:** CPU_FAN1
- CN Type:** 4-pin wafer, p=2.54 mm
- CN Location:** See **Figure 3-10**
- CN Pinouts:** See **Table 3-9**

The fan connector attaches to a CPU cooling fan.

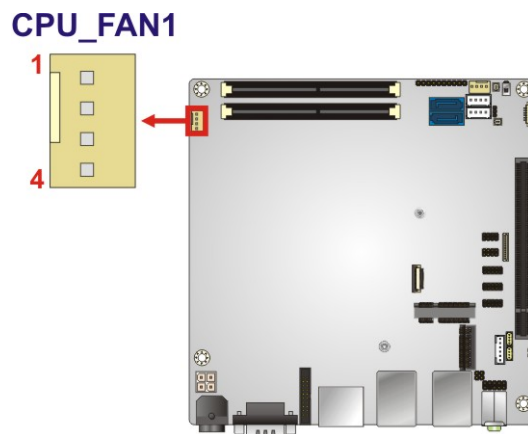

Figure 3-10: CPU Fan Connector Location

Pin	Description
1	GND
2	+12V
3	FANIO
4	PWM

Table 3-9: CPU Fan Connector Pinouts

3.2.7 Fan Connector (System)

- CN Label:** **SYS_FAN1**
- CN Type:** 4-pin wafer, p=2.54 mm
- CN Location:** See **Figure 3-11**
- CN Pinouts:** See **Table 3-10**

The fan connector attaches to a system cooling fan.

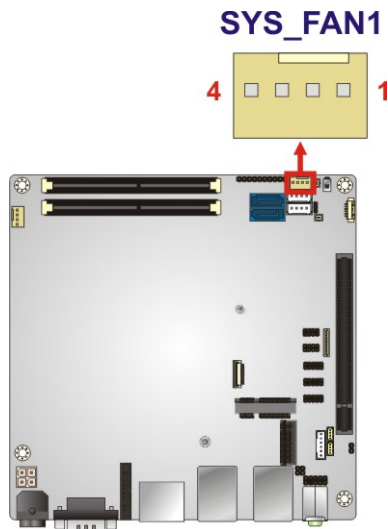

Figure 3-11: System Fan Connector Location

Pin	Description
1	GND
2	+12V
3	FANIO
4	PWM

Table 3-10: System Fan Connector Pinouts

KINO-DH110 Mini-ITX Motherboard

3.2.8 Front Panel Connector

- CN Label:** F_PANEL1
- CN Type:** 10-pin header, p=2.54 mm
- CN Location:** See **Figure 3-12**
- CN Pinouts:** See **Table 3-11**

The front panel connector connects to the indicator LEDs and buttons on the computer's front panel.

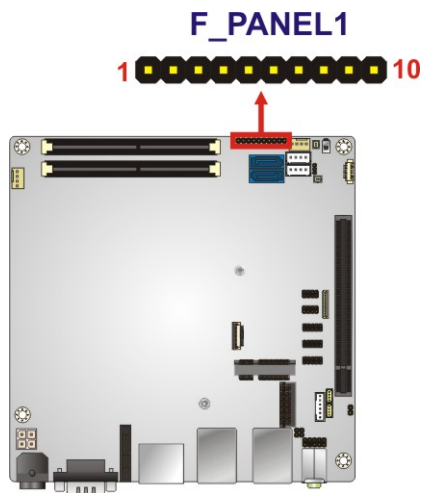

Figure 3-12: Front Panel Connector Location

Function	Pin	Description	Function	Pin	Description
	1	NC	Power LED	6	PWR_LED+
Power Button	2	PWR_BTN+		7	PWR_LED+
	3	PWR_BTN-		8	PWR_LED-
HDD LED	4	HDD_LED+	Reset	9	RESET+
	5	HDD_LED-		10	RESET-

Table 3-11: Front Panel Connector Pinouts

3.2.9 I²C Connector

- CN Label:** I2C1
- CN Type:** 4-pin wafer, p=1.25 mm
- CN Location:** See **Figure 3-13**
- CN Pinouts:** See **Table 3-12**

The I²C connector is used to connect I²C-bus devices to the motherboard.

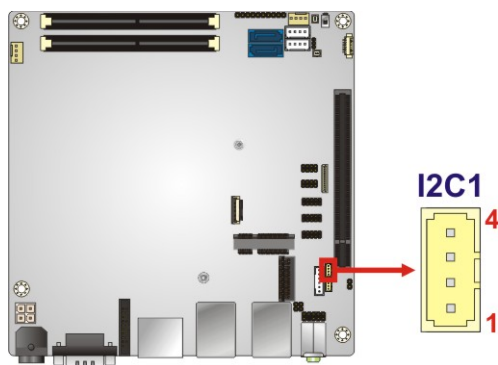

Figure 3-13: I²C Connector Location

Pin	Description
1	GND
2	I2C_DATA
3	I2C_CLK
4	+5V

Table 3-12: I²C Connector Pinouts

KINO-DH110 Mini-ITX Motherboard

3.2.10 Internal DisplayPort Connector

- CN Label:** DP1
- CN Type:** 20-pin box header, p=2.00 mm
- CN Location:** See **Figure 3-14**
- CN Pinouts:** See **Table 3-13**

The internal DisplayPort connector supports HDMI, LVDS, VGA, DVI and DisplayPort graphics interfaces.

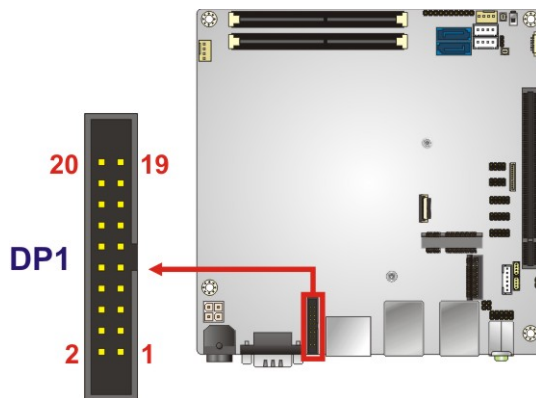

Figure 3-14: Internal DisplayPort Connector Location

Pin	Description	Pin	Description
1	HPD	2	AUX_P
3	GND	4	AUX_N
5	AUX_DET	6	GND
7	GND	8	LANE2P
9	LANE3P	10	LANE2N
11	LANE3N	12	GND
13	GND	14	LANE0P
15	LANE1P	16	LANE0N
17	LANE1N	18	VCC3V
19	VCC5V	20	NC

Table 3-13: Internal DisplayPort Connector Pinouts

3.2.1 Internal Power Connector

- CN Label:** CN2
- CN Type:** 4-pin Molex power connector, p=4.2 mm
- CN Location:** See **Figure 3-15**
- CN Pinouts:** See **Table 3-14**

This connector provides power to the system.

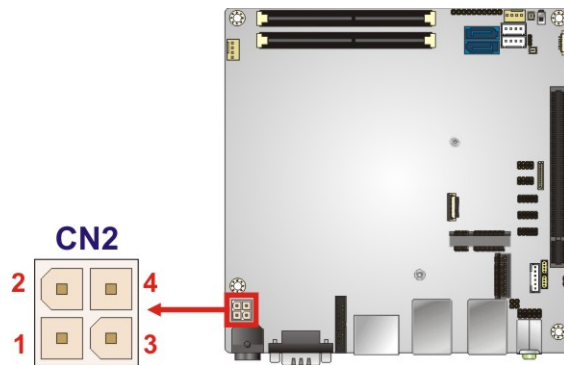

Figure 3-15: Internal Power Connector Pinout Location

Pin	Description	Pin	Description
1	GND	2	GND
3	VCC	4	VCC

Table 3-14: Internal Power Connector Pinouts

KINO-DH110 Mini-ITX Motherboard

3.2.2 Keyboard and Mouse Connector

- CN Label:** KB_MS1
- CN Type:** 6-pin wafer, p=2.00 mm
- CN Location:** See **Figure 3-16**
- CN Pinouts:** See **Table 3-15**

The keyboard and mouse connector connects to a PS/2 Y-cable that can be connected to a PS/2 keyboard and mouse.

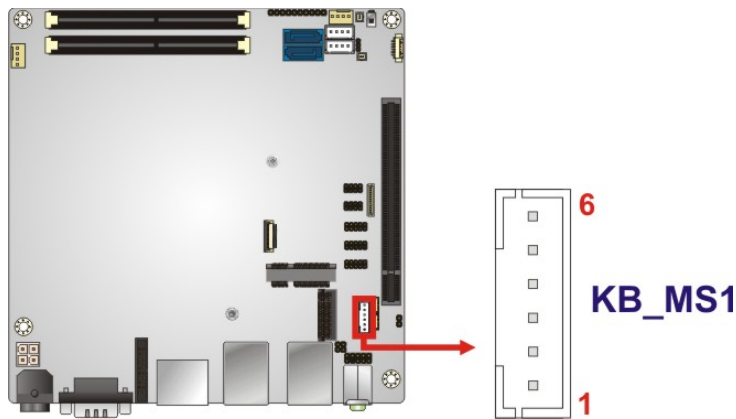

Figure 3-16: Keyboard and Mouse Connector Location

Pin	Description
1	VCC
2	Mouse Data
3	Mouse Clock
4	Keyboard Data
5	Keyboard Clock
6	GND

Table 3-15: Keyboard and Mouse Connector Pinouts

3.2.3 LAN LED Connectors

CN Label: LED_LAN1, LED_LAN2

CN Type: 2-pin header, p=2.54 mm

CN Location: See **Figure 3-17**

CN Pinouts: See **Table 3-16**

The LAN LED connectors are used to connect to the LAN LED indicators on the chassis to indicate users the link activities of the two LAN ports.

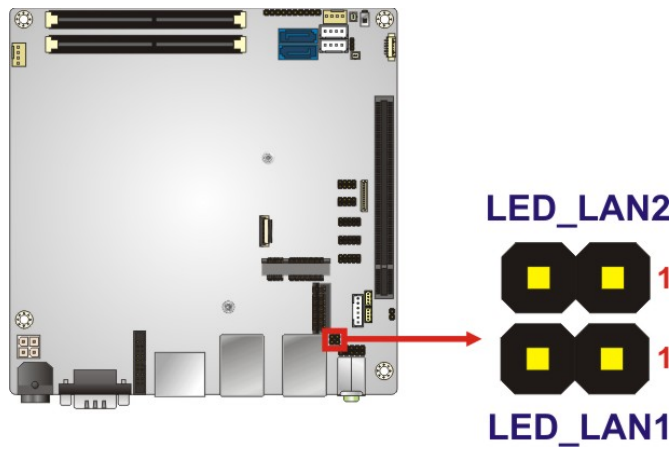

Figure 3-17: LAN LED Connector Locations

Pin	Description
1	+3.3V
2	LAN_LED_LINK#_ACT

Table 3-16: LAN LED Connector Pinouts

KINO-DH110 Mini-ITX Motherboard

3.2.1 M.2 Slot

CN Label:	M_2_SATA1
CN Type:	M.2 B-key slot
CN Location:	See Figure 3-18

The M.2 slot is keyed in the B position and accepts 2242 size of M.2 modules. The M.2 slot supports SATA interfaces only.

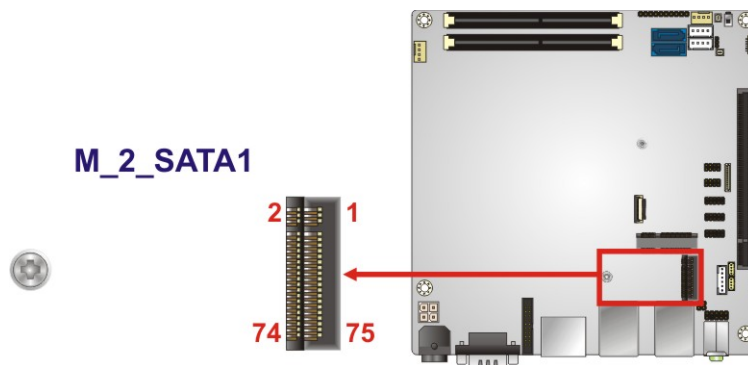

Figure 3-18: M.2 Slot Location

3.2.2 PCIe x16 Slot

CN Label:	PCIEX16_1
CN Type:	PCIe x16 slot
CN Location:	See Figure 3-19

The PCIe x16 expansion card slot is for PCIe x16 expansion card.

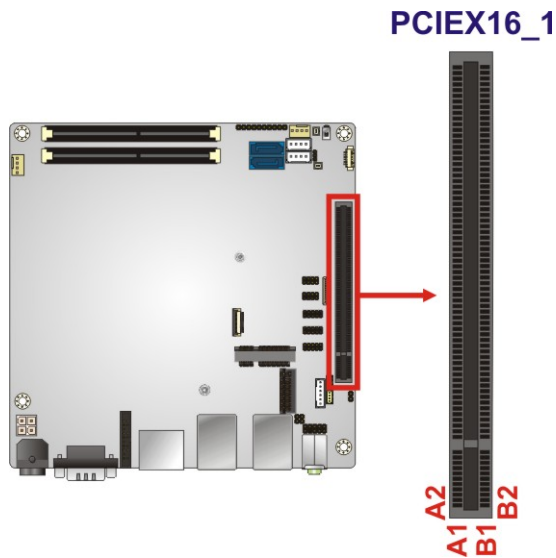

Figure 3-19: PCIe x16 Slot Location

3.2.3 PCIe Mini Slot

- CN Label:** MPCIE1
- CN Type:** Full-size PCIe Mini slot
- CN Location:** See **Figure 3-20**
- CN Pinouts:** See **Table 3-17**

The PCIe Mini slot supporting PCIe and USB signals is for installing a full-size PCIe Mini expansion card.

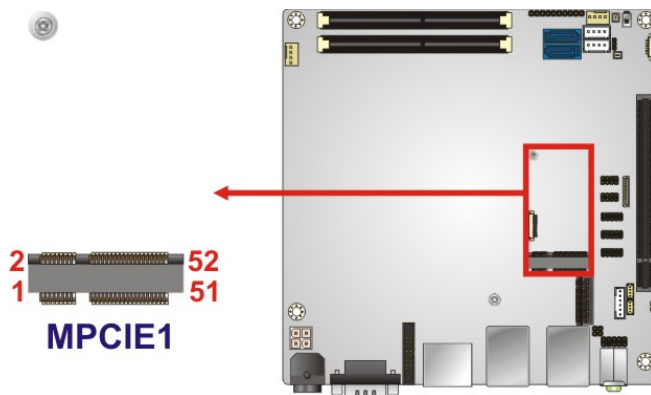

Figure 3-20: PCIe Mini Slot Location

KINO-DH110 Mini-ITX Motherboard

Pin	Description	Pin	Description
1	PCIE_WAKE#	2	VCC3
3	N/C	4	GND
5	N/C	6	1.5V
7	N/C	8	N/C
9	GND	10	N/C
11	PCIE_CLK#	12	N/C
13	PCIE_CLK	14	N/C
15	GND	16	N/C
17	N/C	18	GND
19	N/C	20	N/C
21	GND	22	PCIRST#
23	PCIE_RXN	24	VCC3
25	PCIE_RXP	26	GND
27	GND	28	1.5V
29	GND	30	SMBCLK
31	PCIE_TXN	32	SMBDATA
33	PCIE_TXP	34	GND
35	GND	36	USB D-
37	GND	38	USB D+
39	VCC3	40	GND
41	VCC3	42	N/C
43	GND	44	N/C
45	N/C	46	N/C
47	N/C	48	1.5V
49	N/C	50	GND
51	N/C	52	VCC3

Table 3-17: PCIe Mini Slot Pinouts

3.2.4 RS-232 Serial Port Connectors

- CN Label:** COM3, COM4
- CN Type:** 10-pin header, p=2.00 mm
- CN Location:** See **Figure 3-21**
- CN Pinouts:** See **Table 3-18**

Each of these connectors provides RS-232 connections.

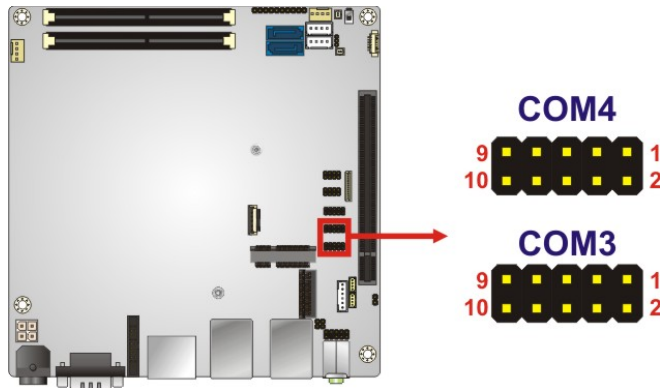

Figure 3-21: RS-232 Serial Port Connector Locations

Pin	Description	Pin	Description
1	DCD	2	DSR
3	RX	4	RTS
5	TX	6	CTS
7	DTR	8	RI
9	GND	10	GND

Table 3-18: RS-232 Serial Port Connector Pinouts

KINO-DH110 Mini-ITX Motherboard

3.2.5 SATA 6Gb/s Drive Connectors

- CN Label:** S_ATA1, S_ATA2
- CN Type:** 7-pin SATA drive connector
- CN Location:** See **Figure 3-22**
- CN Pinouts:** See **Table 3-19**

The SATA drive connectors can be connected to SATA drives and supports up to 6Gb/s data transfer rate.

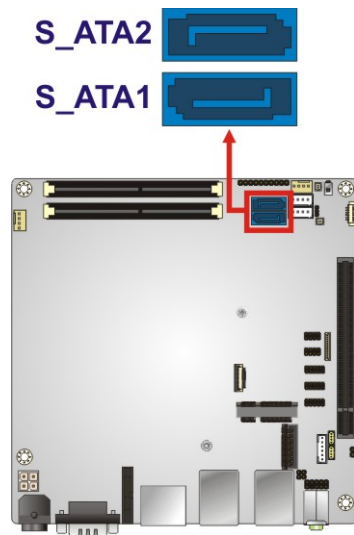

Figure 3-22: SATA 6Gb/s Drive Connector Locations

Pin	Description	Pin	Description
1	GND	2	SATA_TXP
3	SATA_TXN	4	GND
5	SATA_RXN	6	SATA_RXP
7	GND		

Table 3-19: SATA 6Gb/s Drive Connector Pinouts

3.2.1 SATA Power Connectors

CN Label: SATA_PWR1, SATA_PWR2

CN Type: 4-pin wafer

CN Location: See **Figure 3-23**

CN Pinouts: See **Table 3-20**

Use the SATA Power Connector to connect to SATA device power connections.

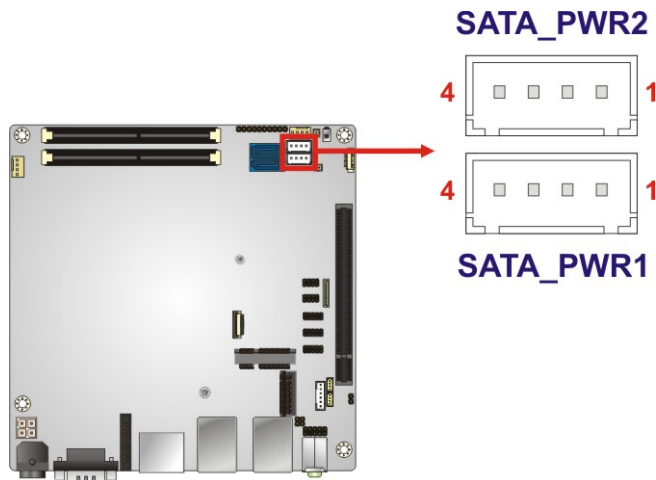

Figure 3-23: SATA Power Connector Locations

Pin	Description
1	+12V
2	GND
3	GND
4	+5V

Table 3-20: SATA Power Connector Pinouts

KINO-DH110 Mini-ITX Motherboard

3.2.2 SMBus Connector

- CN Label:** SMB1
- CN Type:** 4-pin wafer, p=1.25 mm
- CN Location:** See **Figure 3-24**
- CN Pinouts:** See **Table 3-21**

The SMBus (System Management Bus) connector provides low-speed system management communications.

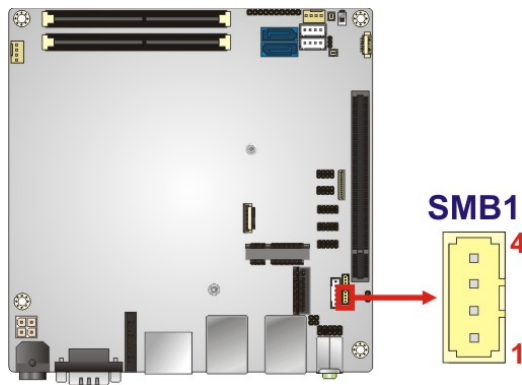

Figure 3-24: SMBus Connector Location

Pin	Description
1	GND
2	SMB_DATA
3	SMB_CLK
4	+5V

Table 3-21: SMBus Connector Pinouts

3.2.3 SPI Flash Connector

- CN Label:** JSPI1
- CN Type:** 6-pin wafer, p=1.25 mm
- CN Location:** See **Figure 3-25**
- CN Pinouts:** See **Table 3-22**

The SPI flash connector is used to flash the SPI ROM.

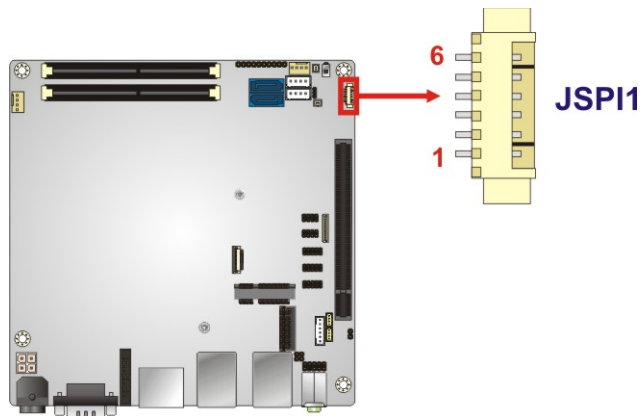

Figure 3-25: SPI Flash Connector Location

Pin	Description
1	+3.3V
2	SPI_CS
3	SPI_SO
4	SPI_CLK
5	SPI_SI
6	GND

Table 3-22: SPI Flash Connector Pinouts

KINO-DH110 Mini-ITX Motherboard

3.2.4 SPI Flash Connector, EC

- CN Label:** JSPI2
- CN Type:** 6-pin wafer, p=1.25 mm
- CN Location:** See **Figure 3-26**
- CN Pinouts:** See **Table 3-23**

The SPI flash connector is used to flash the EC ROM.

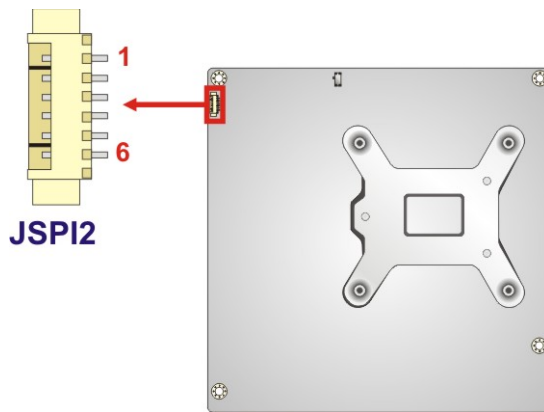

Figure 3-26: SPI EC Flash Connector Location

Pin	Description
1	+3.3V
2	SPI_CS_EC
3	SPI_SO_EC
4	SPI_CLK_EC
5	SPI_SI_EC
6	GND

Table 3-23: SPI EC Flash Connector Pinouts

3.2.5 USB 2.0 Connectors

- CN Label:** USB1, USB2
- CN Type:** 8-pin header, p=2.00 mm
- CN Location:** See **Figure 3-27**
- CN Pinouts:** See **Table 3-24**

The USB 2.0 connectors connect to USB 2.0/1.1 devices. Each pin header provides two USB 2.0 ports.

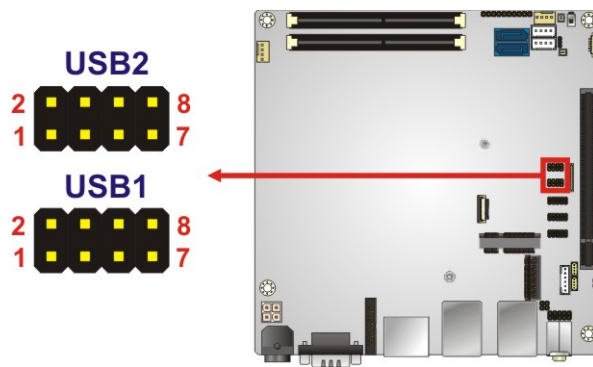

Figure 3-27: USB 2.0 Connector Locations

Pin	Description	Pin	Description
1	VCC	2	GND
3	DATA-	4	DATA+
5	DATA+	6	DATA-
7	GND	8	VCC

Table 3-24: USB 2.0 Connector Pinouts

KINO-DH110 Mini-ITX Motherboard

3.3 External Peripheral Interface Connector Panel

The figure below shows the external peripheral interface connector (EPIC) panel. The EPIC panel consists of the following:

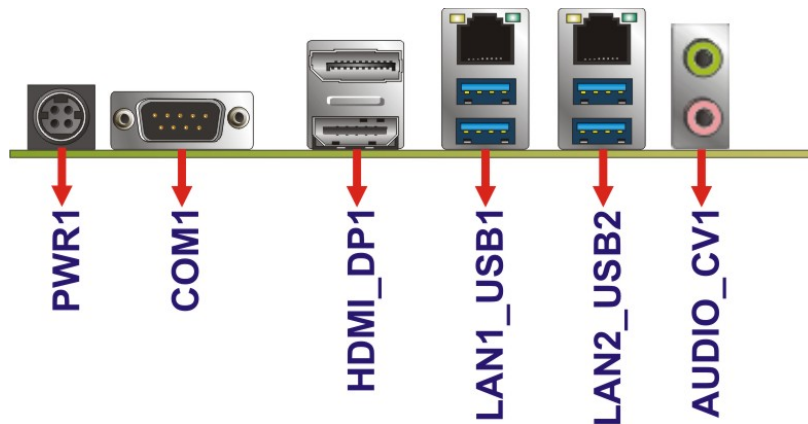

Figure 3-28: External Peripheral Interface Connector

3.3.1 Audio Connector

CN Label: AUDIO_CV1
CN Type: Audio jack
CN Location: See **Figure 3-28**

The audio jacks connect to external audio devices.

- **Line Out port (Lime):** Connects to a headphone or a speaker. With multi-channel configurations, this port can also connect to front speakers.
- **Microphone (Pink):** Connects a microphone.



Figure 3-29: Audio Connector

3.3.2 Ethernet and USB 3.0 Connectors

- CN Label:** LAN1_USB1, LAN2_USB2
- CN Type:** RJ-45, USB 3.0
- CN Location:** See **Figure 3-28**
- CN Pinouts:** See **Table 3-25** and **Table 3-26**

There are four external USB 3.0 connectors on the KINO-DH110.

Pin	Description	Pin	Description
1	VCC	10	VCC
2	USB_DATA-	11	USB_DATA-
3	USB_DATA+	12	USB_DATA+
4	GND	13	GND
5	USB3_RX-	14	USB3_RX-
6	USB3_RX+	15	USB3_RX+
7	GND	16	GND
8	USB3_TX-	17	USB3_TX-
9	USB3_TX+	18	USB3_TX+

Table 3-25: USB 3.0 Port Pinouts

Each LAN connector connects to a local network.

Pin	Description	Pin	Description
1	LAN_MDI0P	5	LAN_MDI2P
2	LAN_MDI0N	6	LAN_MDI2N
3	LAN_MDI1P	7	LAN_MDI3P
4	LAN_MDI1N	8	LAN_MDI3N

Table 3-26: LAN Pinouts

KINO-DH110 Mini-ITX Motherboard

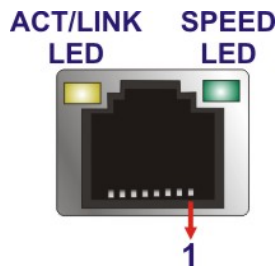

Figure 3-30: LAN Connector

3.3.1 RS-232/422/485 Serial Port Connectors

- CN Label:** COM1
- CN Type:** 10-pin header, p=2.00 mm
- CN Location:** See **Figure 3-28**
- CN Pinouts:** See **Table 3-27**

The external COM1 serial port provides RS-232/422/485 connections.



NOTE:

The communication protocol of the COM1 serial port is set through the BIOS menu in “Advanced → F81866 Super IO Configuration → Serial Port 1 Configuration”. Use the **Transfer Mode** BIOS option to configure the correspondent serial ports (refer to **Sections 5.3.4.2** for detailed information).

The pinouts of the COM1 DB-9 connector are listed below.

RS-232 Pinouts	RS-422 Pinouts	RS-485 Pinouts
<p>DSR(6) RTS(7) CTS(8) RI(9)</p>		

Table 3-27: DB-9 RS-232/422/485 Pinouts

3.3.1 HDMI and DP++ Connector

- CN Label:** HDMI_DP1
- CN Type:** HDMI, DisplayPort
- CN Location:** See **Figure 3-28**
- CN Pinouts:** See **Table 3-28** and **Table 3-29**

The HDMI connector can connect to an HDMI device.

Pin	Description	Pin	Description
1	HDMI_DATA2	2	GND
3	HDMI_DATA2#	4	HDMI_DATA1
5	GND	6	HDMI_DATA1#
7	HDMI_DATA0	8	GND
9	HDMI_DATA0#	10	HDMI_CLK
11	GND	12	HDMI_CLK#
13	N/C	14	N/C
15	HDMI_SCL	16	HDMI_SDA
17	GND	18	+5V
19	HDMI_HPD	20	HDMI_GND
21	HDMI_GND	22	HDMI_GND
23	HDMI_GND		

Table 3-28: HDMI Connector Pinouts

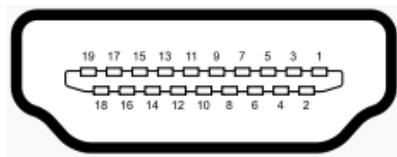

Figure 3-31: HDMI Connector

The DP++ connector connects to a display device with DisplayPort interface.

Pin	Description	Pin	Description
1	HDMI_DATA2	13	NC
2	GND	14	NC

KINO-DH110 Mini-ITX Motherboard

Pin	Description	Pin	Description
3	HDMI_DATA2#	15	HDMI_SCL
4	HDMI_DATA1	16	HDMI_SDA
5	GND	17	GND
6	HDMI_DATA1#	18	+5V
7	HDMI_DATA0	19	HDMI_HPD
8	GND	20	HDMI_GND
9	HDMI_DATA0#	21	HDMI_GND
10	HDMI_CLK	22	HDMI_GND
11	GND	23	HDMI_GND
12	HDMI_CLK#		

Table 3-29: DP++ Connector Pinouts

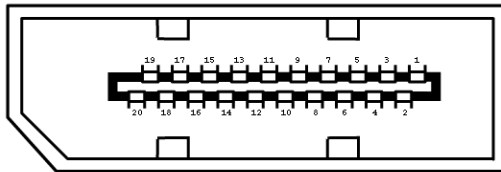

Figure 3-32: HDMI Connector

3.3.1 Power Connector (Power Adapter)

- CN Label:** PWR1
- CN Type:** 4-pin Mini-DIN
- CN Location:** See **Figure 3-28**
- CN Pinouts:** See **Figure 3-33**

The external power connector supports power adapter.

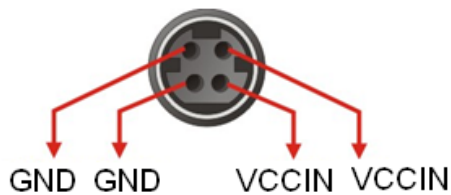

Figure 3-33: 4-pin Power Mini-DIN Connector

Chapter

4

Installation

KINO-DH110 Mini-ITX Motherboard

4.1 Anti-static Precautions



WARNING:

Failure to take ESD precautions during the installation of the KINO-DH110 may result in permanent damage to the KINO-DH110 and severe injury to the user.

Electrostatic discharge (ESD) can cause serious damage to electronic components, including the KINO-DH110. Dry climates are especially susceptible to ESD. It is therefore critical that whenever the KINO-DH110 or any other electrical component is handled, the following anti-static precautions are strictly adhered to.

- ***Wear an anti-static wristband:*** - Wearing a simple anti-static wristband can help to prevent ESD from damaging the board.
- ***Self-grounding:***- Before handling the board touch any grounded conducting material. During the time the board is handled, frequently touch any conducting materials that are connected to the ground.
- ***Use an anti-static pad:*** When configuring the KINO-DH110, place it on an anti-static pad. This reduces the possibility of ESD damaging the KINO-DH110.
- ***Only handle the edges of the PCB:-:*** When handling the PCB, hold the PCB by the edges.

4.2 Installation Considerations



NOTE:

The following installation notices and installation considerations should be read and understood before installation. All installation notices must be strictly adhered to. Failing to adhere to these precautions may lead to severe damage and injury to the person performing the installation.

**WARNING:**

The installation instructions described in this manual should be carefully followed in order to prevent damage to the components and injury to the user.

Before and during the installation please **DO** the following:

- Read the user manual:
 - The user manual provides a complete description of the KINO-DH110 installation instructions and configuration options.
- Wear an electrostatic discharge cuff (ESD):
 - Electronic components are easily damaged by ESD. Wearing an ESD cuff removes ESD from the body and helps prevent ESD damage.
- Place the KINO-DH110 on an anti-static pad:
 - When installing or configuring the motherboard, place it on an anti-static pad. This helps to prevent potential ESD damage.
- Turn all power to the KINO-DH110 off:
 - When working with the KINO-DH110, make sure that it is disconnected from all power supplies and that no electricity is being fed into the system.

Before and during the installation of the KINO-DH110, **DO NOT:**

- Remove any of the stickers on the PCB board. These stickers are required for warranty validation.
- Use the product before verifying all the cables and power connectors are properly connected.
- Allow screws to come in contact with the PCB circuit, connector pins, or its components.

KINO-DH110 Mini-ITX Motherboard

4.3 Socket LGA1151 CPU Installation



WARNING:

CPUs are expensive and sensitive components. When installing the CPU please be careful not to damage it in anyway. Make sure the CPU is installed properly and ensure the correct cooling kit is properly installed.

DO NOT touch the pins at the bottom of the CPU. When handling the CPU, only hold it on the sides.

To install the CPU, follow the steps below.

Step 1: Disengage the load lever by pressing the lever down and slightly outward to clear the retention tab. Fully open the lever. See **Figure 4-1**.

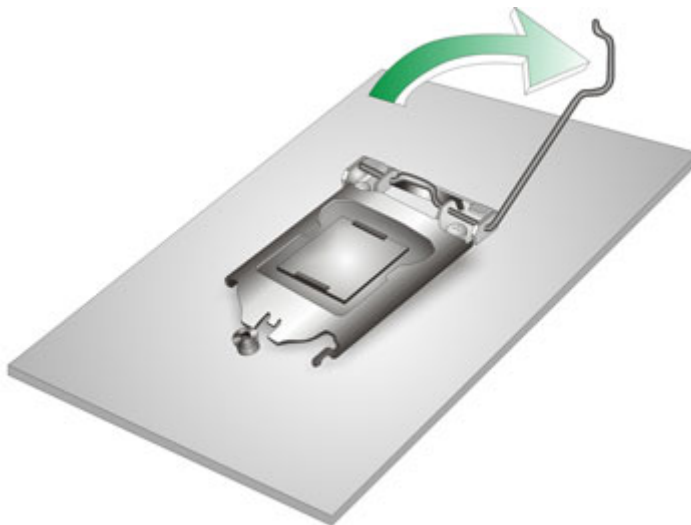

Figure 4-1: Disengage the CPU Socket Load Lever

Step 2: Open the socket and remove the protective cover. The black protective cover can be removed by pulling up on the tab labeled "Remove". See **Figure 4-2**.

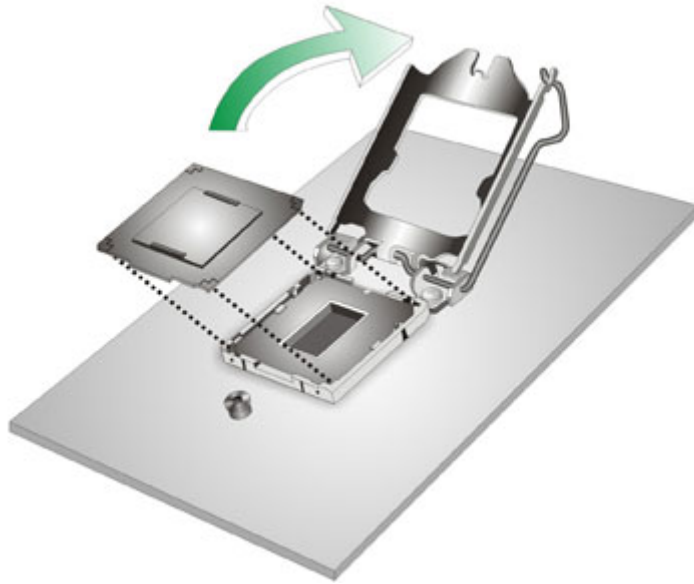

Figure 4-2: Remove Protective Cover

- Step 3: Inspect the CPU socket.** Make sure there are no bent pins and make sure the socket contacts are free of foreign material. If any debris is found, remove it with compressed air.
- Step 4: Orientate the CPU properly.** The contact array should be facing the CPU socket.



WARNING:

DO NOT touch the pins at the bottom of the CPU. When handling the CPU, only hold it on the sides.

-
- Step 5: Correctly position the CPU.** Match the Pin 1 mark with the cut edge on the CPU socket.
- Step 6: Align the CPU pins.** Locate pin 1 and the two orientation notches on the CPU. Carefully match the two orientation notches on the CPU with the socket alignment keys.

KINO-DH110 Mini-ITX Motherboard

Step 7: Insert the CPU. Gently insert the CPU into the socket. If the CPU pins are properly aligned, the CPU should slide into the CPU socket smoothly. See **Figure 4-3**.

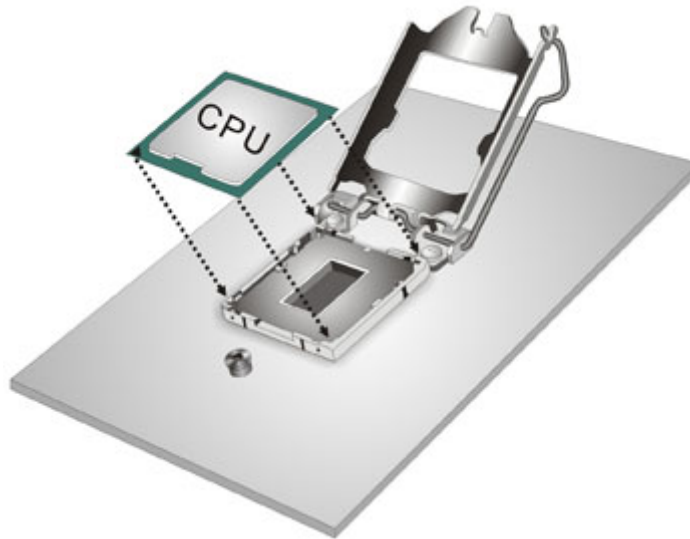

Figure 4-3: Insert the Socket LGA1151 CPU

Step 8: Close the CPU socket. Close the load plate and pull the load lever back a little to have the load plate be able to secure to the knob. Engage the load lever by pushing it back to its original position (**Figure 4-4**). There will be some resistance, but will not require extreme pressure.

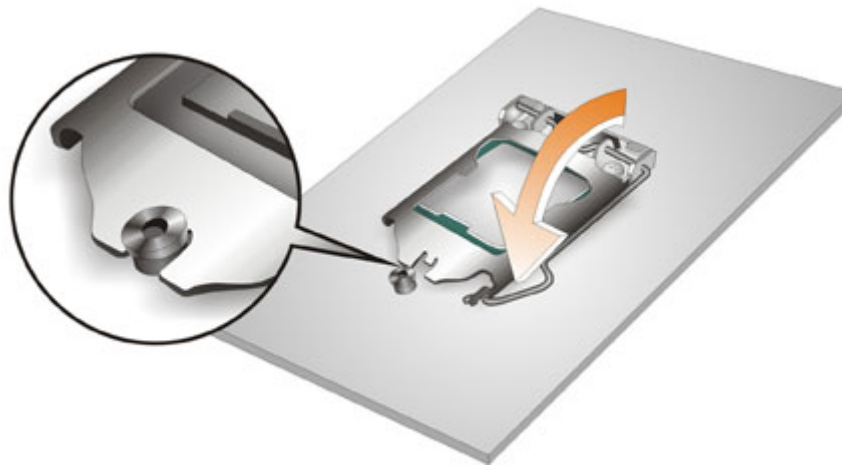

Figure 4-4: Close the Socket LGA1151

4.4 Socket LGA1151 Cooling Kit Installation

**WARNING:**

DO NOT attempt to install a push-pin cooling fan.

The pre-installed support bracket prevents the board from bending and is **ONLY** compatible with captive screw type cooling fans.

The cooling kit can be bought from IEI. The cooling kit has a heat sink and fan.

**WARNING:**

Do not wipe off (accidentally or otherwise) the pre-sprayed layer of thermal paste on the bottom of the heat sink. The thermal paste between the CPU and the heat sink is important for optimum heat dissipation.

To install the cooling kit, follow the instructions below.

Step 1: A cooling kit bracket is pre-installed on the rear of the motherboard. See **Figure 4-5**.

KINO-DH110 Mini-ITX Motherboard

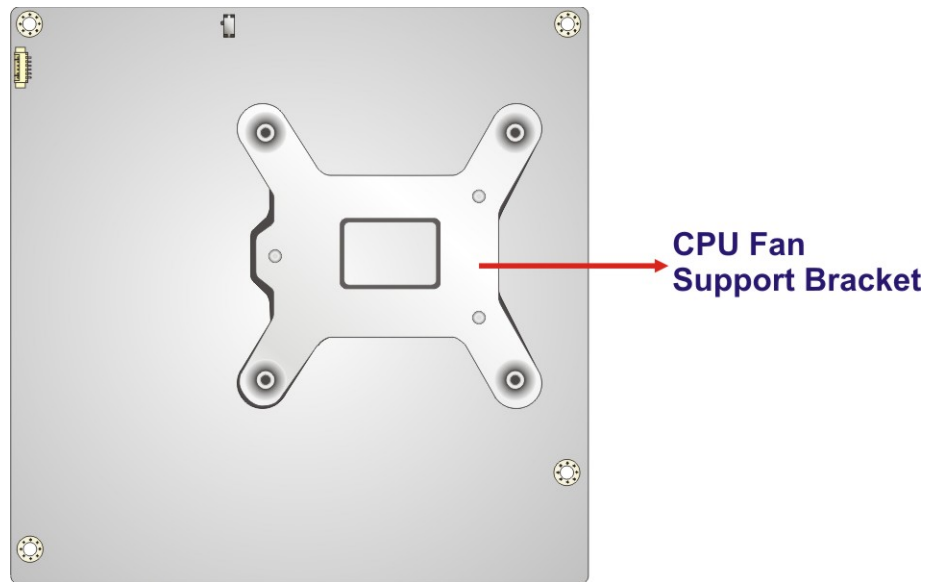

Figure 4-5: Cooling Kit Support Bracket

- Step 2: Place the cooling kit onto the socket LGA1151 CPU.** Make sure the CPU cable can be properly routed when the cooling kit is installed.
- Step 3: Mount the cooling kit.** Gently place the cooling kit on top of the CPU. Make sure the four threaded screws on the corners of the cooling kit properly pass through the holes of the cooling kit bracket.
- Step 4: Tighten the screws.** Use a screwdriver to tighten the four screws. In a diagonal pattern, tighten each screw a few turns then move to the next one, until they are all secured. Do not overtighten the screws.
- Step 5: Connect the fan cable.** Connect the cooling kit fan cable to the CPU fan connector on the KINO-DH110. Carefully route the cable and avoid heat generating chips and fan blades.

4.5 SO-DIMM Installation



CAUTION:

For dual channel configuration, always install two identical memory modules that feature the same capacity, timings, voltage, number of ranks and the same brand.

To install a SO-DIMM, please follow the steps below and refer to Figure 4-6.

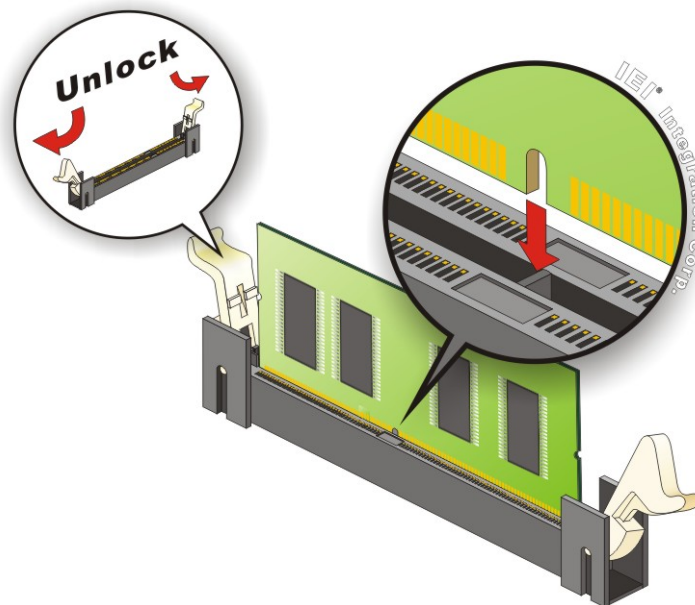

Figure 4-6: SO-DIMM Installation (DDR4)

- Step 1: Open the SO-DIMM socket handles.** Open the two handles outwards as far as they can. See Figure 4-6.
- Step 2: Align the SO-DIMM with the socket.** Align the SO-DIMM so the notch on the memory lines up with the notch on the memory socket. See Figure 4-6.
- Step 3: Insert the SO-DIMM.** Once aligned, press down until the SO-DIMM is properly seated. Clip the two handles into place. See Figure 4-6.

KINO-DH110 Mini-ITX Motherboard

Step 4: Removing a SO-DIMM. To remove a SO-DIMM, push both handles outward.

The memory module is ejected by a mechanism in the socket.

4.6 Full-size PCIe Mini Card Installation

The PCIe Mini card slot allows installation of a full-size PCIe Mini card. To install a full-size PCIe Mini card, please follow the steps below.

Step 1: Locate the PCIe Mini card slot. See Chapter 3.

Step 2: Remove the retention screw. Remove the retention screw as shown in Figure 4-7.

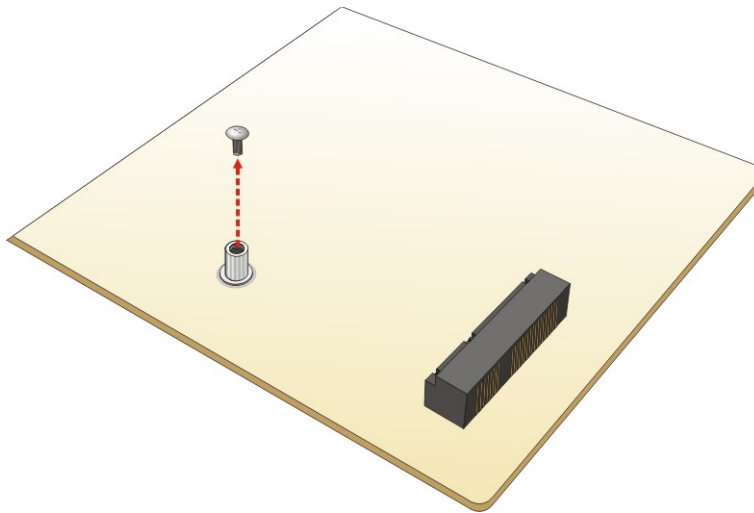

Figure 4-7: Removing the Retention Screw

Step 3: Insert into the socket at an angle. Line up the notch on the card with the notch on the slot. Slide the PCIe Mini card into the socket at an angle of about 20° (Figure 4-8).

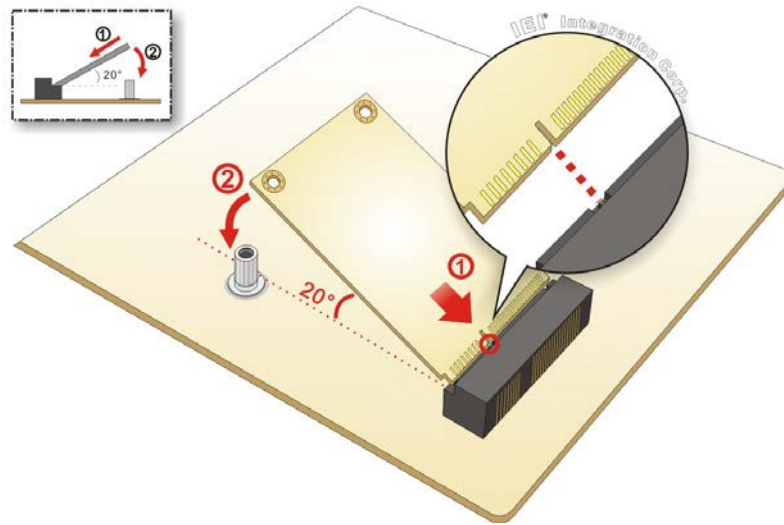

Figure 4-8: Inserting the Full-size PCIe Mini Card into the Slot at an Angle

Step 4: Secure the full-size PCIe Mini card. Secure the full-size PCIe Mini card with the retention screw previously removed (**Figure 4-9**).

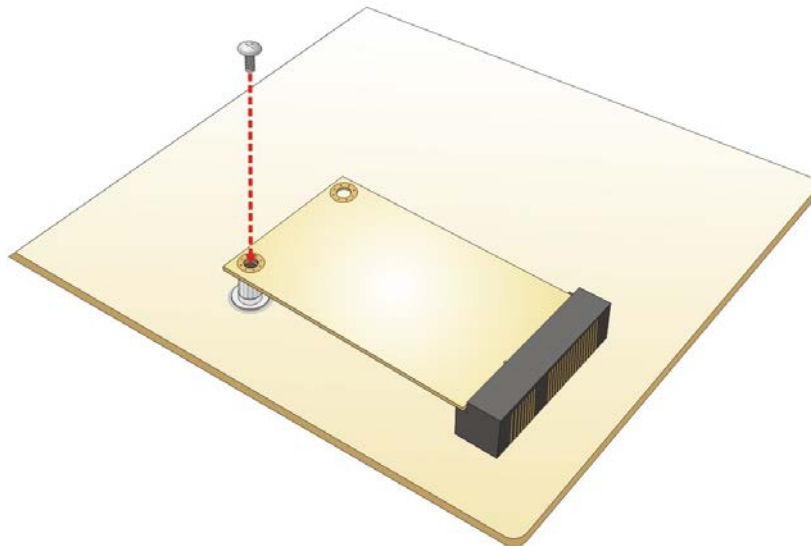

Figure 4-9: Securing the Full-size PCIe Mini Card

KINO-DH110 Mini-ITX Motherboard

4.7 M.2 Module Installation

To install an M.2 module, please follow the steps below.

Step 1: Locate the M.2 module slot. See **Chapter 3**. Remove the on-board retention screw.

Step 2: Line up the notch on the module with the notch on the slot. Slide the M.2 module into the socket at an angle of about 20° (**Figure 4-10**).

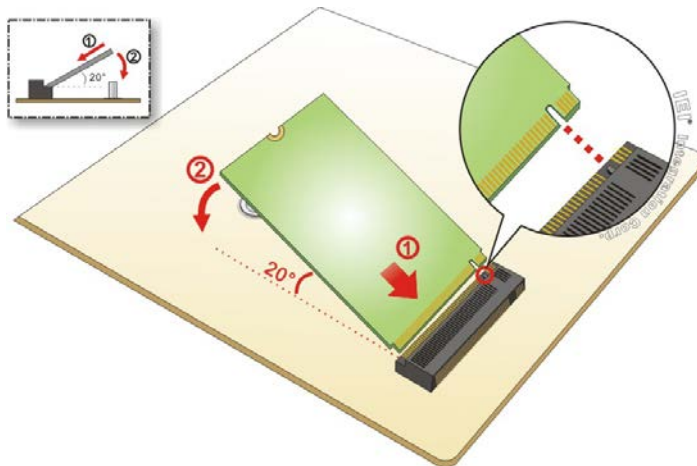

Figure 4-10: Inserting the M.2 Module into the Slot at an Angle

Step 3: Secure the M.2 module with an M2*3 retention screw (**Figure 4-11**).

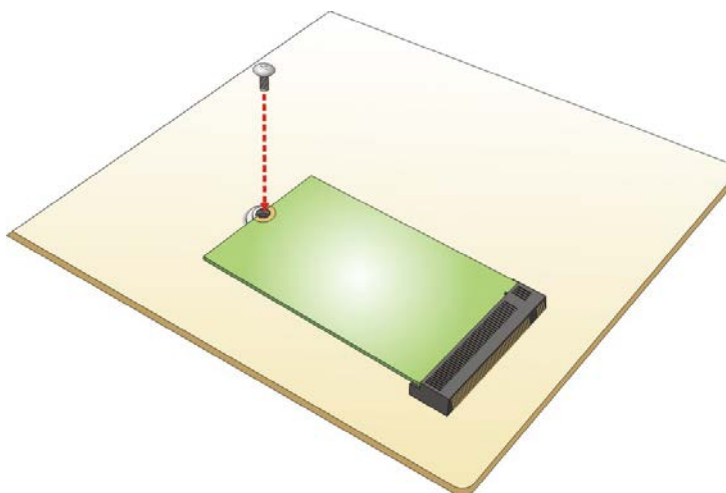

Figure 4-11: Securing the M.2 Module

4.8 System Configuration

The system configuration should be performed before installation.

4.8.1 AT/ATX Power Mode Setting

The AT and ATX power mode selection is made through the AT/ATX power mode switch which is shown in **Figure 4-12**.

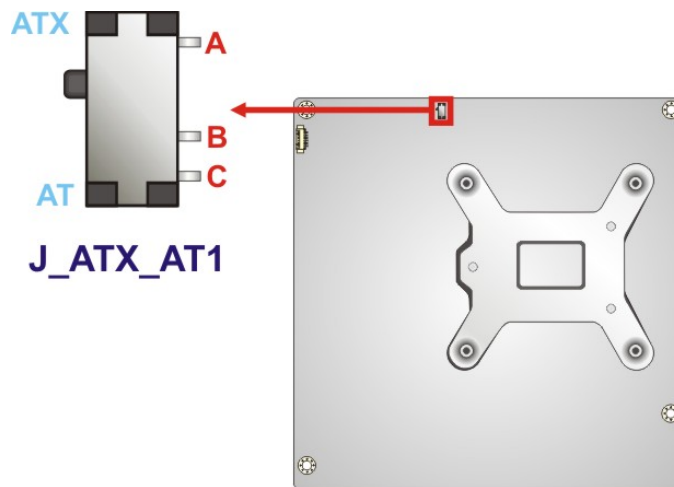

Figure 4-12: AT/ATX Power Mode Switch Location

Setting	Description
Short A-B	ATX power mode (default)
Short B-C	AT power mode

Table 4-1: AT/ATX Power Mode Switch Settings

4.8.2 Clear CMOS Button

To reset the BIOS, remove the on-board battery and press the clear CMOS button for three seconds or more. The clear CMOS button location is shown in **Figure 4-13**.

KINO-DH110 Mini-ITX Motherboard

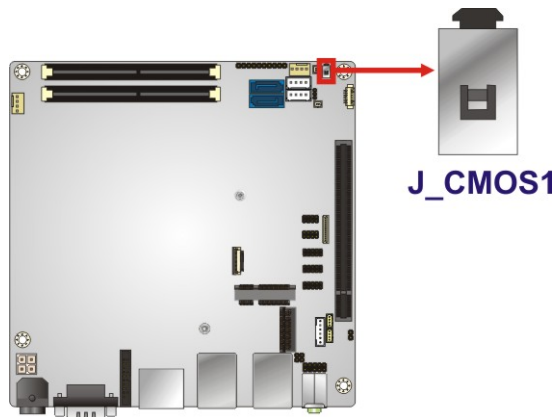

Figure 4-13: Clear CMOS Button Location

4.8.3 Flash Descriptor Security Override Jumper

The flash descriptor security override jumper (J_FLASH1) allows to enable or disable the ME firmware update. Refer to **Table 4-2** and **Figure 4-14** for the jumper location and settings.

Setting	Description
Short 1-2	Disabled
Short 2-3	Enabled

Table 4-2: Flash Descriptor Security Override Jumper Settings

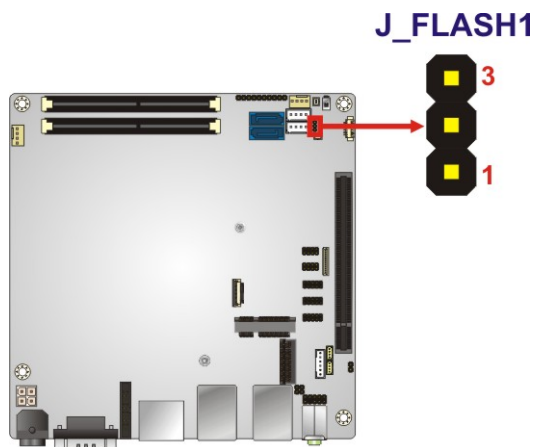

Figure 4-14: Flash Descriptor Security Override Jumper Location

To update the ME firmware, please follow the steps below.

- Step 1:** Before turning on the system power, short pin 2-3 of the flash descriptor security override jumper.
- Step 2:** Update the BIOS and ME firmware, and then turn off the system power.
- Step 3:** Remove the metal clip on the flash descriptor security override jumper or return to its default setting (short pin 1-2).
- Step 4:** Restart the system. The system will reboot 2 ~ 3 times to complete the ME firmware update.

4.8.4 USB Power Selection

The USB power selection is made through the BIOS menu in “Chipset → PCH-IO Configuration”. Use the **USB Power SW1** and the **USB Power SW2** BIOS options to configure the correspondent USB ports (see **Table 4-3**) and refer to **Table 4-4** to select the USB power source.

BIOS Options	Configured USB Ports
USB Power SW1	LAN1_USB1 (external USB 3.0 ports) LAN2_USB2 (external USB 3.0 ports)
USB Power SW2	USB1 (internal USB 2.0 ports) USB2 (internal USB 2.0 ports)

Table 4-3: BIOS Options and Configured USB Ports

Options	Description
+5V DUAL	+5V dual (default)
+5V	+5V

Table 4-4: USB Power Source Setup

Please refer to **Section 5.4.2** for BIOS setup.

KINO-DH110 Mini-ITX Motherboard

4.9 Internal Peripheral Device Connections

This section outlines the installation of peripheral devices to the onboard connectors.

4.9.1 SATA Drive Connection

The KINO-DH110 is shipped with a SATA drive cable. To connect the SATA drive to the connector, please follow the steps below.

Step 1: Locate the SATA connector and the SATA power connector. The locations of the connectors are shown in **Chapter 3**.

Step 2: Insert the cable connector. Insert the cable connector into the on-board SATA drive connector and the SATA power connector. See **Figure 4-15**.

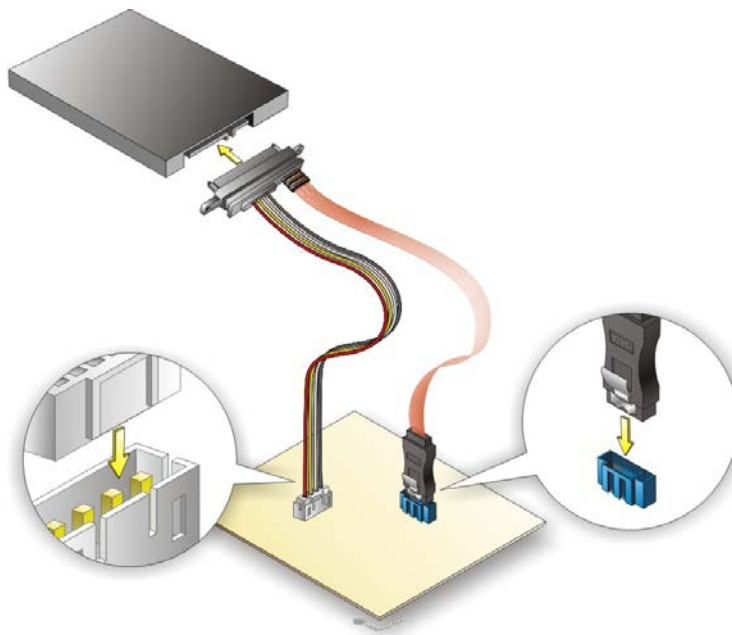

Figure 4-15: SATA Drive Cable Connection

Step 3: Connect the cable to the SATA disk. Connect the connector on the other end of the cable to the connector at the back of the SATA drive. See **Figure 4-15**.

Step 4: To remove the SATA cable from the SATA connector, press the clip on the connector at the end of the cable.

4.10 Available Drivers

All the drivers for the KINO-DH110 are available on IEI Resource Download Center (<https://download.ieiworld.com>). Type KINO-DH110 and press Enter to find all the relevant software, utilities, and documentation.

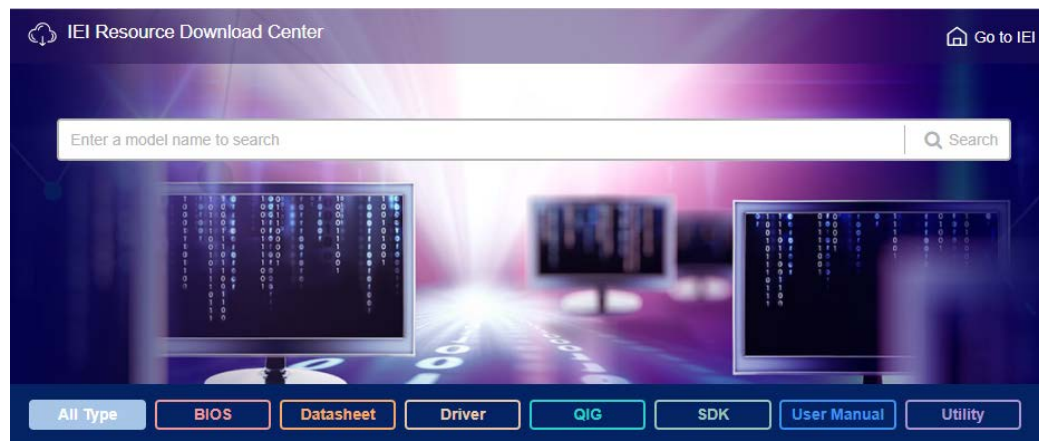

Figure 4-16: IEI Resource Download Center

IEI provides the following drivers for Windows 7, Windows 8 and Windows 10 operating systems.

- Chipset
- VGA
- LAN
- Audio
- USB 3.0 (Windows 7 OS only)
- ME (Intel® AMT)
- Kernel-Mode Driver Framework (Windows 7 OS only)
- Intel® Serial IO (Windows 8.1/10 64-bit OS only)

KINO-DH110 Mini-ITX Motherboard

4.10.1 Driver Download

To download drivers from IEI Resource Download Center, follow the steps below.

Step 1: Go to <https://download.ieiworld.com>. Type KINO-DH110 and press Enter.



Step 2: All product-related software, utilities, and documentation will be listed. You can choose **Driver** to filter the result.

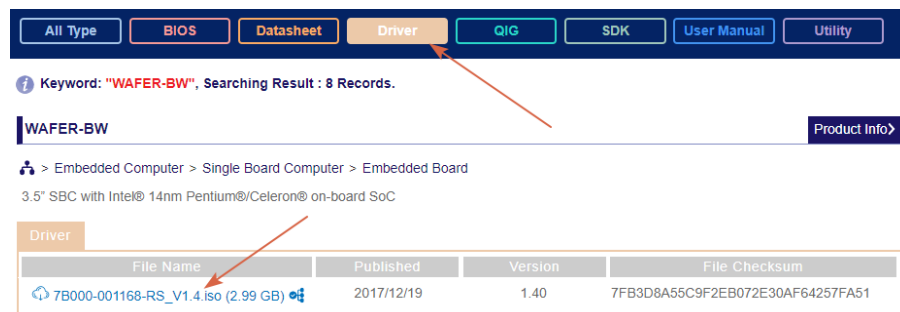

Step 3: Click the driver file name on the page and you will be prompted with the following window. You can download the entire ISO file (❶), or click the small arrow to find an individual driver and click the file name to download (❷).

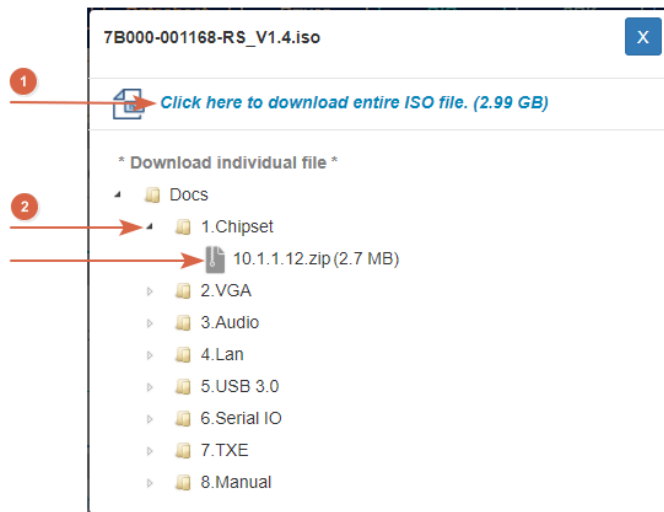

**NOTE:**

To install software from the downloaded ISO image file in Windows 8, 8.1 or 10, double-click the ISO file to mount it as a virtual drive to view its content. On Windows 7 system, an additional tool (such as Virtual CD-ROM Control Panel from Microsoft) is needed to mount the file.

4.11 Adding USB 3.0 Drivers to a Windows 7 Installation Image

The Windows 7 installation media does not include native driver support for USB 3.0. In order to use the USB keyboard or mouse connected to a USB 3.0 port during OS installation, the user has to update the Windows 7 installation image so that it contains USB 3.0 drivers. Please follow the instructions below to complete the task.

Step 1: Prepare a USB flash drive installer.

On a working computer, use your Windows 7 DVD or ISO image to create a bootable USB flash drive.

Step 2: Download the Windows 7 USB 3.0 Creator Utility from:

<https://downloadcenter.intel.com/download/25476/Windows-7-USB-3-0-Creator-Utility>.

Step 3: Extract the downloaded file to a temporary folder on a computer where the user has logged in as the administrator.

**NOTE:**

The OS version of the computer can be Windows 7, Windows 8.1 or Windows 10.

KINO-DH110 Mini-ITX Motherboard

- Step 4:** Connect the USB drive containing the Windows 7 installation image to the computer.
- Step 5:** Right click on **Installer_Creator.exe** from the extracted files and select **Run as administrator**.
- Step 6:** The Windows 7 USB 3.0 Creator Utility screen appears (**Figure 4-17**). Click  to browse to the root of the USB drive containing the Windows 7 image.

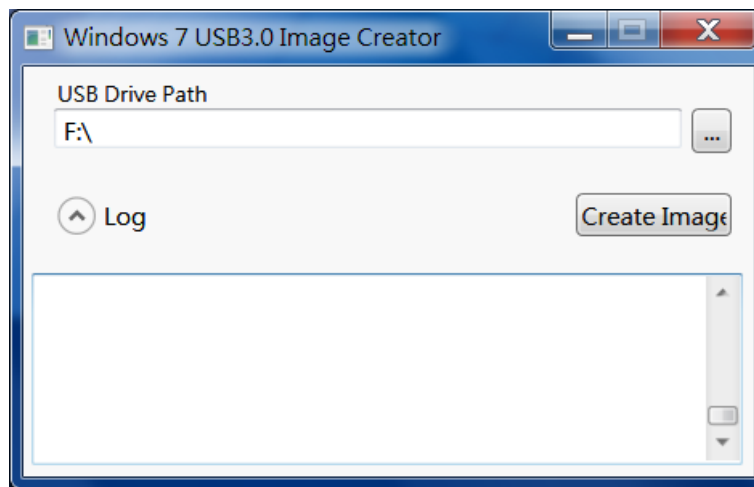

Figure 4-17: Windows 7 USB 3.0 Creator Utility

- Step 7:** Click **Create Image** to start the update process.

Step 8: Wait for the process to finish. It may take up to 15 minutes.

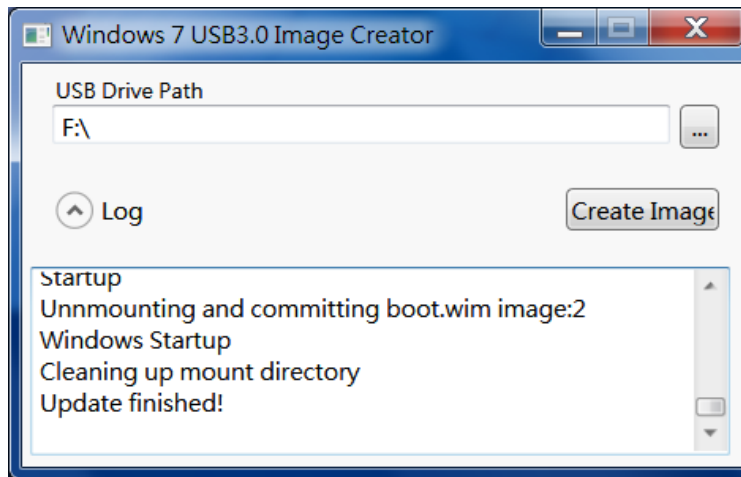

Figure 4-18: Update Process is Complete

Step 9: Now the user can proceed with the Windows 7 installation using the updated installer.

4.12 Intel® AMT Setup Procedure

The KINO-DH110 is featured with the Intel® Active Management Technology (AMT). To enable the Intel® AMT function, follow the steps below.

Step 1: Make sure at least one of the memory sockets is installed with a DDR4 DIMM.

Step 2: Connect an Ethernet cable to the RJ-45 connector labeled **LAN1_USB1**.

Step 3: The AMI BIOS options regarding the Intel® ME or Intel® AMT must be enabled,

Step 4: Properly install the Intel® Management Engine Components drivers from the iAMT Driver & Utility directory in the driver CD.

Step 5: Configure the Intel® Management Engine BIOS extension (MEBx). To get into the Intel® MEBx settings, press <Ctrl+P> after a single beep during boot-up process. Enter the Intel® current ME password as it requires (the Intel® default password is **admin**).

KINO-DH110 Mini-ITX Motherboard



NOTE:

To change the password, enter a new password following the strong password rule (containing at least one upper case letter, one lower case letter, one digit and one special character, and be at least eight characters).

Chapter

5

BIOS

KINO-DH110 Mini-ITX Motherboard

5.1 Introduction

The BIOS is programmed onto the BIOS chip. The BIOS setup program allows changes to certain system settings. This chapter outlines the options that can be changed.



NOTE:

Some of the BIOS options may vary throughout the life cycle of the product and are subject to change without prior notice.

5.1.1 Starting Setup

The UEFI BIOS is activated when the computer is turned on. The setup program can be activated in one of two ways.

1. Press the **DEL** or **F2** key as soon as the system is turned on or
2. Press the **DEL** or **F2** key when the “**Press DEL or F2 to enter SETUP**” message appears on the screen.

If the message disappears before the **DEL** or **F2** key is pressed, restart the computer and try again.

5.1.2 Using Setup

Use the arrow keys to highlight items, press **ENTER** to select, use the PageUp and PageDown keys to change entries, press **F1** for help and press **ESC** to quit. Navigation keys are shown in the following table.

Key	Function
Up arrow	Move to previous item
Down arrow	Move to next item
Left arrow	Move to the item on the left hand side
Right arrow	Move to the item on the right hand side
+	Increase the numeric value or make changes
-	Decrease the numeric value or make changes
Page Up	Move to the previous page
Page Dn	Move to the next page

Key	Function
Esc	Main Menu – Quit and not save changes into CMOS Status Page Setup Menu and Option Page Setup Menu -- Exit current page and return to Main Menu
F1	General help, only for Status Page Setup Menu and Option Page Setup Menu
F2	Load previous values
F3	Load optimized defaults
F4	Save changes and Exit BIOS

Table 5-1: BIOS Navigation Keys

5.1.3 Getting Help

When **F1** is pressed, a small help window describing the appropriate keys to use and the possible selections for the highlighted item appears. To exit the Help Window, press **Esc**.

5.1.4 Unable to Reboot after Configuration Changes

If the computer cannot boot after changes to the system configuration is made, CMOS defaults. Use the clear CMOS button described in **Chapter 4**.

5.1.5 BIOS Menu Bar

The **menu bar** on top of the BIOS screen has the following main items:

- Main – Changes the basic system configuration.
- Advanced – Changes the advanced system settings.
- Chipset – Changes the chipset settings.
- Security – Sets User and Supervisor Passwords.
- Boot – Changes the system boot configuration.
- Save & Exit – Selects exit options and loads default settings

The following sections completely describe the configuration options found in the menu items at the top of the BIOS screen and listed above.

KINO-DH110 Mini-ITX Motherboard

5.2 Main

The **Main** BIOS menu (**BIOS Menu 1**) appears when the **BIOS Setup** program is entered.

The **Main** menu gives an overview of the basic system information.

```

Aptio Setup Utility - Copyright (C) 2018 American Megatrends, Inc.
Main  Advanced  Chipset  Security  Boot  Save & Exit

BIOS Information
BIOS Vendor                American Megatrends
Core Version                5.11
Compliancy                 UEFI 2.4; PI 1.3
Project Version            B443AT38.ROM
Build Date and Time        03/15/2018 15:06:03

iWDD Vendor                iEi
iWDD Version                B443ET15.bin

Processor Information
Name                       SkyLake DT
Type                       Intel(R) Core(TM)
                           i5-6500TE CPU @ 2.30GHz
Speed                      2300 MHz
ID                         0x506E3
Stepping                   R0/S0/N0
Number of Processors       4Core(s) / 4Thread(s)
Microcode Revision         C2
GT Info                     GT2 (0x1912)

IGFX VBIOS Version         1054
Memory RC Version          2.0.0.6
Total Memory                4096 MB
Memory Frequency            2133 MHz

PCH Information
Name                       SKL PCH-H
PCH SKU                     H110
Stepping                    D1
LAN PHY Revision            A6 (B2 Stepping)

ME FW Version               11.8.50.3434
ME Firmware SKU             Consumer SKU

SPI Clock Frequency
Dual Output Fast Read support  Unsupported
Read ID/Status Clock Freq    17 MHz
Write and Erase Clock Freq    48 MHz
Fast Read Clock Freq          48 MHz

Access Level                 Administrator

System Date                 [Thu 01/12/2010]
System Time                 [15:10:27]

-----
-><: Select Screen
↑ ↓: Select Item
Enter: Select
+/-: Change Opt.
F1:  General Help
F2:  Previous Values
F3:  Optimized Defaults
F4:  Save & Exit
ESC: Exit

Version 2.18.1263. Copyright (C) 2018 American Megatrends, Inc.
  
```

BIOS Menu 1: Main

The **Main** menu has two user configurable fields:

→ **System Date [xx/xx/xx]**

Use the **System Date** option to set the system date. Manually enter the day, month and year.

→ **System Time [xx:xx:xx]**

Use the **System Time** option to set the system time. Manually enter the hours, minutes and seconds.

5.3 Advanced

Use the **Advanced** menu (**BIOS Menu 2**) to configure the CPU and peripheral devices through the following sub-menus:



WARNING!

Setting the wrong values in the sections below may cause the system to malfunction. Make sure that the settings made are compatible with the hardware.

```

Aptio Setup Utility - Copyright (C) 2018 American Megatrends, Inc.
Main  Advanced  Chipset  Security  Boot  Save & Exit  Server Mgmt
-----
> CPU Configuration
> PCH-FW Configuration
> ACPI Settings
> F81866 Super IO Configuration
> iWDD H/M Monitor
> RTC Wake Settings
> Serial Port Console Redirection
> NVMe Configuration
> USB Configuration
> iEi Feature

Configure Active
Management Technology
Parameters
-----
→←: Select Screen
↑ ↓: Select Item
Enter: Select
+/-: Change Opt.
F1: General Help
F2: Previous Values
F3: Optimized Defaults
F4: Save & Exit
ESC: Exit

Version 2.18.1263. Copyright (C) 2018 American Megatrends, Inc.
    
```

BIOS Menu 2: Advanced

KINO-DH110 Mini-ITX Motherboard

5.3.1 CPU Configuration

Use the **CPU Configuration** menu (**BIOS Menu 3**) to view detailed CPU specifications or enable the Intel Virtualization Technology.

```

Aptio Setup Utility - Copyright (C) 2018 American Megatrends, Inc.
  Advanced
CPU Configuration
Type                Intel(R) Core(TM)
                   i5-6500TE CPU @ 2.30GHz
ID                  0x506E
Speed               2300 MHz
L1 Data Cache      32 kB x 2
L1 Instruction Cache 32 kB x 2
L2 Cache            256 kB x 2
L3 Cache            6 MB
L4 Cache            N/A
VMX                 Supported
SMX/TXT             Supported

Intel (VMX)Virtualization Technology [Disabled]
Active Processor Cores [All]
Intel(R) SpeedStep(tm) [Enabled]
C states             [Disabled]

When enabled, a VMM can utilize the additional hardware capabilities provided by Vanderpool Technology.

-----
-><: Select Screen
^ v: Select Item
Enter: Select
+/-: Change Opt.
F1: General Help
F2: Previous Values
F3: Optimized Defaults
F4: Save & Exit
ESC: Exit

Version 2.18.1263. Copyright (C) 2018 American Megatrends, Inc.
  
```

BIOS Menu 3: CPU Configuration

➔ Intel (VMX) Virtualization Technology [Disabled]

Use the **Intel (VMX) Virtualization Technology** option to enable or disable virtualization on the system. When combined with third party software, Intel® Virtualization technology allows several OSs to run on the same system at the same time.

- ➔ **Disabled** **DEFAULT** Disables Intel Virtualization Technology.
- ➔ **Enabled** Enables Intel Virtualization Technology.

➔ Active Processor Cores [All]

Use the **Active Processor Cores** BIOS option to enable numbers of cores in the processor package.

- All **DEFAULT** Enable all cores in the processor package.
- 1 Enable one core in the processor package.
- 2 Enable two cores in the processor package.
- 3 Enable three cores in the processor package.

→ **Intel(R) SpeedStep(tm) [Enabled]**

Use the **Intel(R) SpeedStep(tm)** option to enable or disable the Intel® SpeedStep Technology which allows more than two frequency ranges to be supported.

- **Disabled** Disables Intel® SpeedStep Technology
- **Enabled** **DEFAULT** Enables Intel® SpeedStep Technology

→ **C States [Disabled]**

Use the **C States** BIOS option to enable or disable CPU power management which allows CPU to go to C states when it is not 100% use.

- **Enabled** Enables CPU power management.
- **Disabled** **DEFAULT** Disables CPU power management.

KINO-DH110 Mini-ITX Motherboard

5.3.2 PCH-FW Configuration

The **PCH-FW Configuration** menu (**BIOS Menu 4**) allows Intel® Active Management Technology (AMT) options to be configured.

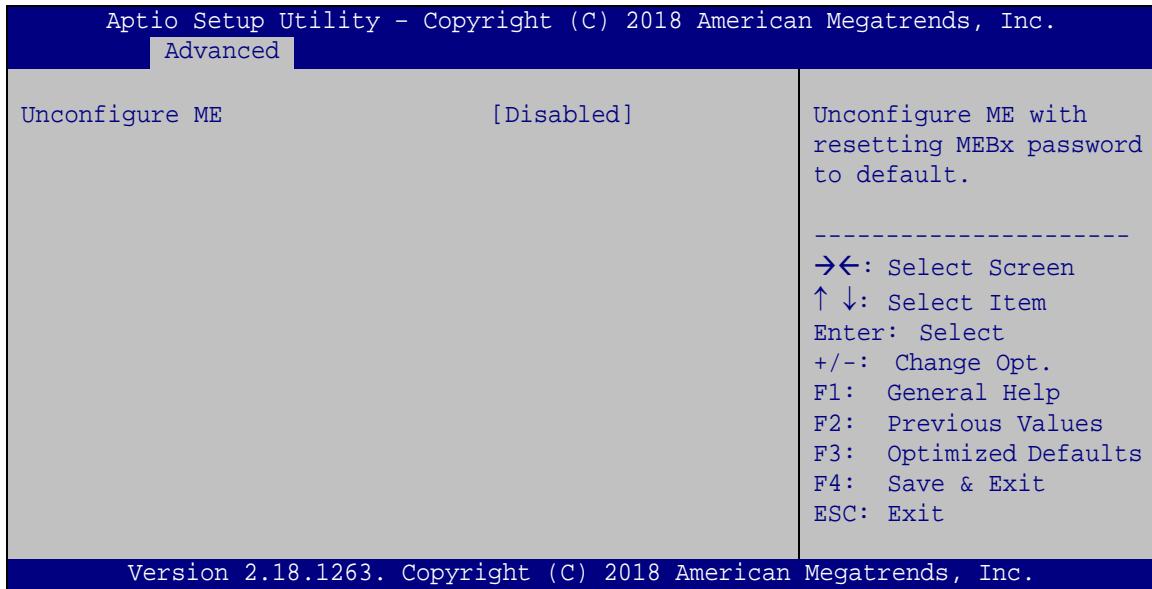

BIOS Menu 4: PCH-FW Configuration

→ Unconfigure ME [Disabled]

Use the **Unconfigure ME** option to perform ME unconfigure without password operation.

- **Disabled** **DEFAULT** Not perform ME unconfigure
- **Enabled** To perform ME unconfigure

5.3.3 ACPI Settings

The **ACPI Settings** menu (**BIOS Menu 5**) configures the Advanced Configuration and Power Interface (ACPI) options.

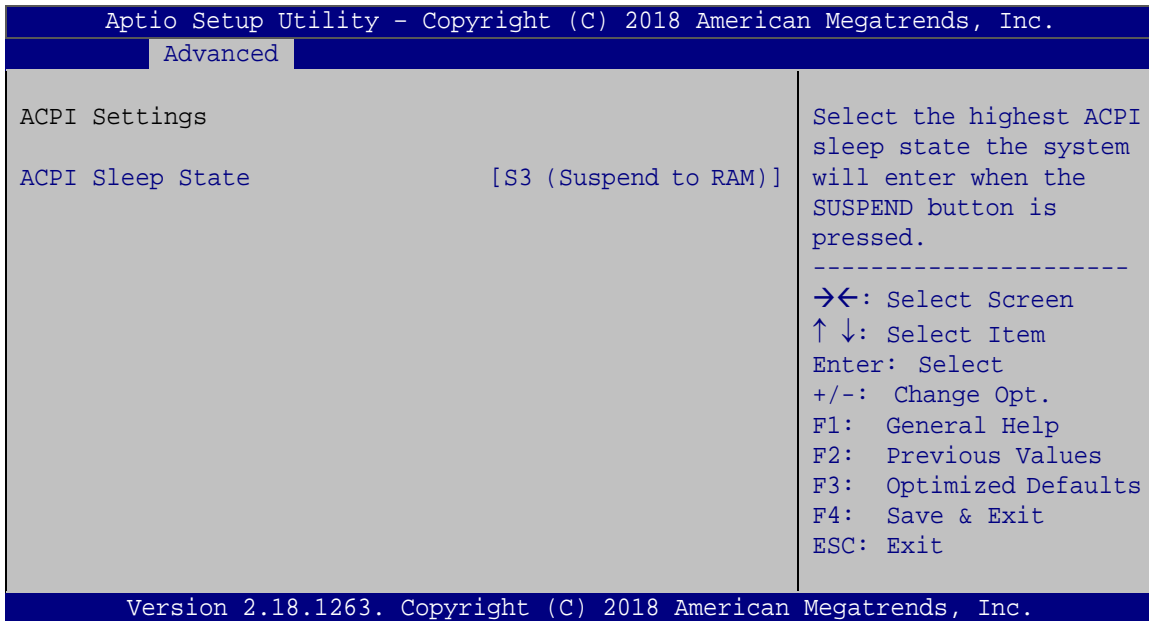

BIOS Menu 5: ACPI Configuration

→ ACPI Sleep State [S3 (Suspend to RAM)]

Use the **ACPI Sleep State** option to specify the sleep state the system enters when it is not being used.

- **S3 (Suspend to RAM)** **DEFAULT** The caches are flushed and the CPU is powered off. Power to the RAM is maintained. The computer returns slower to a working state, but more power is saved.

KINO-DH110 Mini-ITX Motherboard

5.3.4 F81866 Super IO Configuration

Use the **F81866 Super IO Configuration** menu (**BIOS Menu 6**) to set or change the configurations for the parallel ports and serial ports.

```

Aptio Setup Utility - Copyright (C) 2018 American Megatrends, Inc.
  Advanced
Super IO Configuration
Super IO Chip                F81866
> Serial Port 1 Configuration
> Serial Port 3 Configuration
> Serial Port 4 Configuration
Case Open Detection          [Disabled]

Set Parameters of Serial
Port 1 (COMA)
-----
-><: Select Screen
↑↓: Select Item
Enter: Select
+/-: Change Opt.
F1: General Help
F2: Previous Values
F3: Optimized Defaults
F4: Save & Exit
ESC: Exit

Version 2.18.1263. Copyright (C) 2018 American Megatrends, Inc.
  
```

BIOS Menu 6: F81866 Super IO Configuration

➔ Case Open Detection [Disabled]

Use the **Case Open Detection** option to enable or disable the case open detection function.

- ➔ **Disabled** **DEFAULT** Disable the case open detection function
- ➔ **Enabled** Enable the case open detection function

5.3.4.1 Serial Port n Configuration

Use the **Serial Port n Configuration** menu (**BIOS Menu 7**) to configure the serial ports.

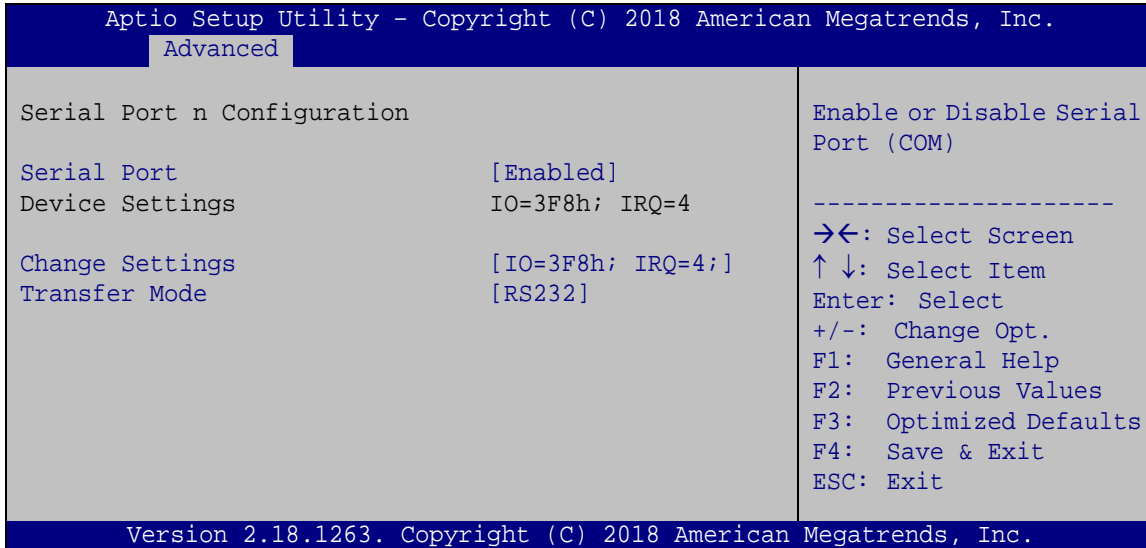

BIOS Menu 7: Serial Port n Configuration Menu

5.3.4.2 Serial Port 1 Configuration

→ Serial Port [Enabled]

Use the **Serial Port** option to enable or disable the serial port.

- **Disabled** Disable the serial port
- **Enabled** **DEFAULT** Enable the serial port

→ Change Settings [Auto]

Use the **Change Settings** option to change the serial port IO port address and interrupt address.

- **IO=3F8h; IRQ=4** **DEFAULT** Serial Port I/O port address is 3F8h and the interrupt address is IRQ4
- **IO=3F8h; IRQ=3, 4, 11** Serial Port I/O port address is 3F8h and the interrupt address is IRQ3, 4, 11

KINO-DH110 Mini-ITX Motherboard

- ➔ **IO=2F8h;**
IRQ=3, 4, 11 Serial Port I/O port address is 2F8h and the interrupt address is IRQ3, 4, 11
- ➔ **IO=3E8h;**
IRQ=3, 4, 11 Serial Port I/O port address is 3E8h and the interrupt address is IRQ3, 4, 11
- ➔ **IO=2E8h;**
IRQ=3, 4, 11 Serial Port I/O port address is 2E8h and the interrupt address is IRQ3, 4, 11

➔ Transfer Mode [RS232]

Use the **Transfer Mode** option to select the Serial Port 1 signaling mode.

- ➔ **RS422** Serial Port 5 signaling mode is RS-422
- ➔ **RS232 DEFAULT** Serial Port 5 signaling mode is RS-232
- ➔ **RS485** Serial Port 5 signaling mode is RS-485

5.3.4.3 Serial Port 3 Configuration

➔ Serial Port [Enabled]

Use the **Serial Port** option to enable or disable the serial port.

- ➔ **Disabled** Disable the serial port
- ➔ **Enabled DEFAULT** Enable the serial port

➔ Change Settings [Auto]

Use the **Change Settings** option to change the serial port IO port address and interrupt address.

- ➔ **IO=3F8h;**
IRQ=3, 4, 11 Serial Port I/O port address is 3F8h and the interrupt address is IRQ3, 4, 11
- ➔ **IO=2F8h;**
IRQ=3, 4, 11 Serial Port I/O port address is 2F8h and the interrupt address is IRQ3, 4, 11
- ➔ **IO=3E8h; DEFAULT** Serial Port I/O port address is 3E8h and the interrupt address is IRQ3, 4, 11

KINO-DH110 Mini-ITX Motherboard

5.3.5 iWDD H/W Monitor

The **iWDD H/W Monitor** menu (**BIOS Menu 8**) contains the fan configuration submenu, and displays operating temperature, fan speeds and system voltages.

```

Aptio Setup Utility - Copyright (C) 2018 American Megatrends, Inc.
Advanced
PC Health Status
CPU temperature           : +38°C
SYS temperature          : +38°C

CPU_FAN1 Speed           : 575 RPM
SYS_FAN1 Speed           : N/A

CPU_CORE                  : +0.932 V
+5V                       : +4.838 V
+12V                      : +12.000 V
+DDR                      : +1.196 V
+3.3V                     : +3.296 V
+3.3VSB                   : +3.294 V

> Smart Fan Mode Configuration

Smart Fan Mode Select

-----
-><: Select Screen
↑↓: Select Item
Enter: Select
+/-: Change Opt.
F1: General Help
F2: Previous Values
F3: Optimized Defaults
F4: Save & Exit
ESC: Exit

Version 2.18.1263. Copyright (C) 2018 American Megatrends, Inc.

```

BIOS Menu 8: iWDD H/W Monitor

→ PC Health Status

The following system parameters and values are shown. The system parameters that are monitored are:

- System Temperatures:
 - CPU Temperature
 - System Temperature
- Fan Speed:
 - CPU Fan Speed
 - System Fan Speed
- Voltages:
 - CPU_CORE
 - +5V
 - +12V
 - +DDR
 - +3.3V
 - +3.3VSB

5.3.5.1 Smart Fan Mode Configuration

Use the **Smart Fan Mode Configuration** submenu (**BIOS Menu 9**) to configure the CPU/system fan temperature and speed settings.

```

Aptio Setup Utility - Copyright (C) 2018 American Megatrends, Inc.
Advanced
Smart Fan Mode Configuration
CPU_FAN1 Smart Fan Control      [Auto Mode]
Auto mode fan start temperature 40
Auto mode fan off temperature   30
Auto mode fan start PWM         30
Auto mode fan slope PWM         2

SYS_FAN1 Smart Fan Control      [Auto Mode]
Auto mode fan start temperature 50
Auto mode fan off temperature   40
Auto mode fan start PWM         30
Auto mode fan slope PWM         1

Smart Fan Mode Select
-----
-><-: Select Screen
↑↓: Select Item
Enter: Select
+/-: Change Opt.
F1: General Help
F2: Previous Values
F3: Optimized Defaults
F4: Save & Exit
ESC: Exit

Version 2.18.1263. Copyright (C) 2018 American Megatrends, Inc.
    
```

BIOS Menu 9: Smart Fan Mode Configuration

→ CPU_FAN1 Smart Fan Control/SYS_FAN1 Smart Fan Control [Auto Mode]

Use the **CPU_FAN1 Smart Fan Control/SYS_FAN1 Smart Fan Control** option to configure the CPU/System Smart Fan.

→ **Manual Mode** The fan spins at the speed set in Manual Mode settings.

→ **Auto Mode** **DEFAULT** The fan adjusts its speed using Auto Mode settings.

→ Auto mode fan start/off temperature

Use the + or – key to change the **Auto mode fan start/off temperature** value. Enter a decimal number between 1 and 100.

→ Auto mode fan start PWM

Use the + or – key to change the **Auto mode fan start PWM** value. Enter a decimal number between 1 and 100.

KINO-DH110 Mini-ITX Motherboard

→ Auto mode fan slope PWM

Use the + or – key to change the **Auto mode fan slope PWM** value. Enter a decimal number between 1 and 8.

5.3.6 RTC Wake Settings

The **RTC Wake Settings** menu (**BIOS Menu 10**) enables the system to wake at the specified time.

```

Aptio Setup Utility - Copyright (C) 2018 American Megatrends, Inc.
  Advanced
Wake system with Fixed Time      [Disabled]
                                   Enable or disable System
                                   wake on alarm event. When
                                   enabled, System will
                                   wake on the
                                   date::hr::min::sec
                                   specified
                                   -----
                                   →←: Select Screen
                                   ↑↓: Select Item
                                   Enter: Select
                                   +/-: Change Opt.
                                   F1:  General Help
                                   F2:  Previous Values
                                   F3:  Optimized Defaults
                                   F4:  Save & Exit
                                   ESC: Exit
Version 2.18.1263. Copyright (C) 2018 American Megatrends, Inc.

```

BIOS Menu 10: RTC Wake Settings

→ Wake system with Fixed Time [Disabled]

Use the **Wake system with Fixed Time** option to enable or disable the system wake on alarm event.

- **Disabled** **DEFAULT** The real time clock (RTC) cannot generate a wake event.

- **Enabled** If selected, the **Wake up every day** option appears allowing you to enable to disable the system to wake every day at the specified time. Besides, the following options appear with values that can be

selected:

Wake up date

Wake up hour

Wake up minute

Wake up second

After setting the alarm, the computer turns itself on from a suspend state when the alarm goes off.

5.3.7 Serial Port Console Redirection

The **Serial Port Console Redirection** menu (**BIOS Menu 11**) allows the console redirection options to be configured. Console redirection allows users to maintain a system remotely by re-directing keyboard input and text output through the serial port.

```

Aptio Setup Utility - Copyright (C) 2018 American Megatrends, Inc.
  Advanced
COM1
  Console Redirection          [Disabled]      Console Redirection
  > Console Redirection Settings      Enable or Disable

COM3
  Console Redirection          [Disabled]
  > Console Redirection Settings

COM4
  Console Redirection          [Disabled]
  > Console Redirection Settings

  Legacy Console Redirection
  > Legacy Console Redirection Settings

-----
-><: Select Screen
↑↓: Select Item
Enter: Select
+/-: Change Opt.
F1:  General Help
F2:  Previous Values
F3:  Optimized Defaults
F4:  Save & Exit
ESC: Exit

Version 2.18.1263. Copyright (C) 2018 American Megatrends, Inc.
  
```

BIOS Menu 11: Serial Port Console Redirection

KINO-DH110 Mini-ITX Motherboard

→ Console Redirection [Disabled]

Use **Console Redirection** option to enable or disable the console redirection function.

- **Disabled** **DEFAULT** Disabled the console redirection function
- **Enabled** Enabled the console redirection function

The following options are available in the **Console Redirection Settings** submenu when the **Console Redirection** option is enabled.

→ Terminal Type [ANSI]

Use the **Terminal Type** option to specify the remote terminal type.

- **VT100** The target terminal type is VT100
- **VT100+** The target terminal type is VT100+
- **VT-UTF8** The target terminal type is VT-UTF8
- **ANSI** **DEFAULT** The target terminal type is ANSI

→ Bits per second [115200]

Use the **Bits per second** option to specify the serial port transmission speed. The speed must match the other side. Long or noisy lines may require lower speeds.

- **9600** Sets the serial port transmission speed at 9600.
- **19200** Sets the serial port transmission speed at 19200.
- **57600** Sets the serial port transmission speed at 57600.
- **115200** **DEFAULT** Sets the serial port transmission speed at 115200.

→ Data Bits [8]

Use the **Data Bits** option to specify the number of data bits.

- **7** Sets the data bits at 7.
- **8** **DEFAULT** Sets the data bits at 8.

→ Parity [None]

Use the **Parity** option to specify the parity bit that can be sent with the data bits for detecting the transmission errors.

- None** **DEFAULT** No parity bit is sent with the data bits.
- Even** The parity bit is 0 if the number of ones in the data bits is even.
- Odd** The parity bit is 0 if the number of ones in the data bits is odd.
- Mark** The parity bit is always 1. This option does not provide error detection.
- Space** The parity bit is always 0. This option does not provide error detection.

→ Stop Bits [1]

Use the **Stop Bits** option to specify the number of stop bits used to indicate the end of a serial data packet. Communication with slow devices may require more than 1 stop bit.

- 1** **DEFAULT** Sets the number of stop bits at 1.
- 2** Sets the number of stop bits at 2.

KINO-DH110 Mini-ITX Motherboard

5.3.7.1 Legacy Console Redirection Settings

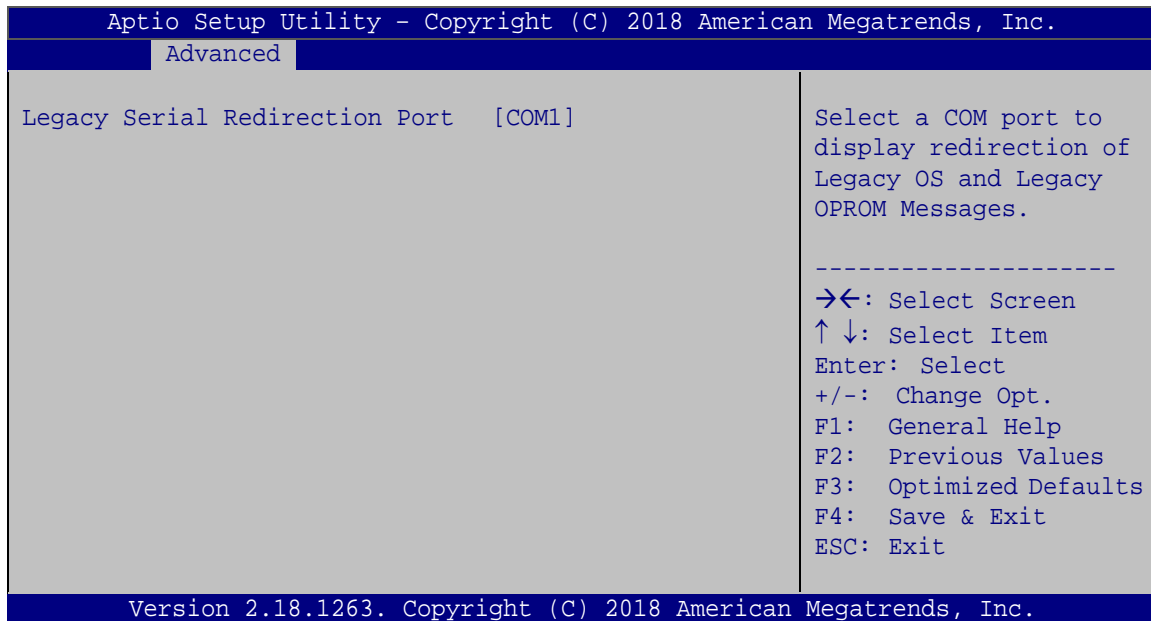

BIOS Menu 12: Legacy Console Redirection Settings

→ Legacy Serial Redirection Port [COM1]

Use the Legacy Serial Redirection Port option to select a COM port to display redirection of legacy OS and legacy OPRM messages.

5.3.8 NVMe Configuration

Use the **NVMe Configuration (BIOS Menu 13)** menu to display the NVMe controller and device information.

```
Aptio Setup Utility - Copyright (C) 2018 American Megatrends, Inc.
Advanced
NVMe controller and Drive information
No NVMe Device Found
-----
-><: Select Screen
↑↓: Select Item
Enter: Select
+/-: Change Opt.
F1: General Help
F2: Previous Values
F3: Optimized Defaults
F4: Save & Exit
ESC: Exit
Version 2.18.1263. Copyright (C) 2018 American Megatrends, Inc.
```

BIOS Menu 13: NVMe Configuration

KINO-DH110 Mini-ITX Motherboard

5.3.9 USB Configuration

Use the **USB Configuration** menu (**BIOS Menu 14**) to read USB configuration information and configure the USB settings.

```

Aptio Setup Utility - Copyright (C) 2018 American Megatrends, Inc.
  Advanced
USB Configuration
USB Controllers:
  1 XHCI
USB Devices:
  1 Keyboard, 1 Hub
Legacy USB Support          [Enabled]
-----
-><: Select Screen
↑ ↓: Select Item
Enter: Select
+/-: Change Opt.
F1: General Help
F2: Previous Values
F3: Optimized Defaults
F4: Save & Exit
ESC: Exit
Version 2.18.1263. Copyright (C) 2018 American Megatrends, Inc.
  
```

BIOS Menu 14: USB Configuration

➔ Legacy USB Support [Enabled]

Use the **Legacy USB Support** BIOS option to enable USB mouse and USB keyboard support. Normally if this option is not enabled, any attached USB mouse or USB keyboard does not become available until a USB compatible operating system is fully booted with all USB drivers loaded. When this option is enabled, any attached USB mouse or USB keyboard can control the system even when there is no USB driver loaded onto the system.

- ➔ **Enabled** **DEFAULT** Legacy USB support enabled
- ➔ **Disabled** Legacy USB support disabled
- ➔ **Auto** Legacy USB support disabled if no USB devices are connected

5.3.10 iEi Feature

Use the **iEi Feature** menu (**BIOS Menu 15**) to configure One Key Recovery function.

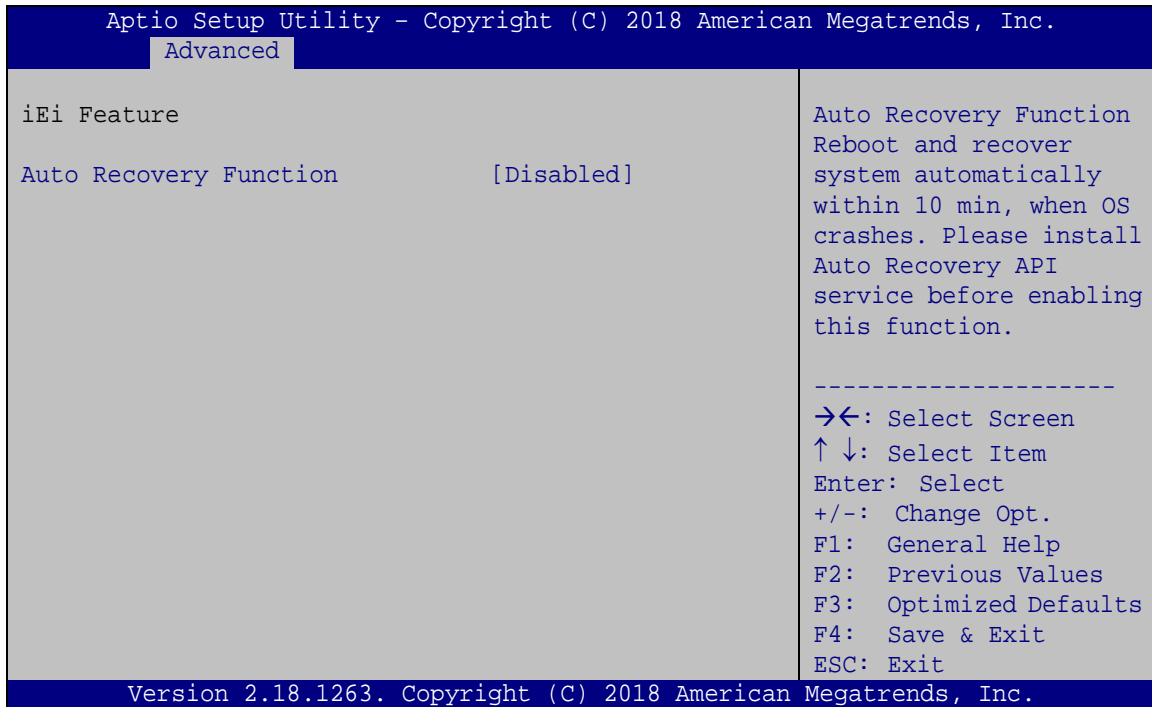

BIOS Menu 15: iEi Feature

→ Auto Recovery Function [Disabled]

Use the **Auto Recovery Function** BIOS option to enable or disable the auto recovery function of the IEI One Key Recovery.

- **Disabled** **DEFAULT** Auto recovery function disabled
- **Enabled** Auto recovery function enabled

KINO-DH110 Mini-ITX Motherboard

5.4 Chipset

Use the **Chipset** menu (**BIOS Menu 16**) to access the PCH IO and System Agent (SA) configuration menus.



WARNING!

Setting the wrong values for the Chipset BIOS selections in the Chipset BIOS menu may cause the system to malfunction.

```

Aptio Setup Utility - Copyright (C) 2018 American Megatrends, Inc.
Main   Advanced  Chipset  Security  Boot   Save & Exit
-----
> System Agent (SA) Configuration      System Agent (SA)
> PCH-IO Configuration                 Parameters
-----
-><: Select Screen
↑ ↓: Select Item
Enter: Select
+/-: Change Opt.
F1: General Help
F2: Previous Values
F3: Optimized Defaults
F4: Save & Exit
ESC: Exit

Version 2.18.1263. Copyright (C) 2018 American Megatrends, Inc.

```

BIOS Menu 16: Chipset

5.4.1 System Agent (SA) Configuration

Use the **System Agent (SA) Configuration** menu (**BIOS Menu 17**) to configure the System Agent (SA) parameters.

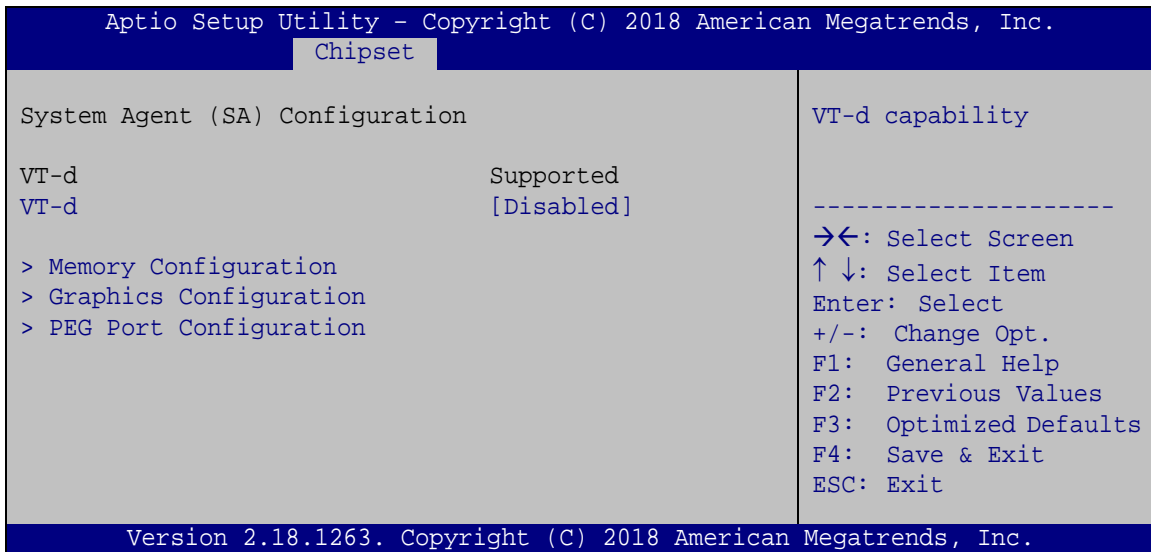

BIOS Menu 17: System Agent (SA) Configuration

→ VT-d [Disabled]

Use the **VT-d** option to enable or disable VT-d capability.

- **Disabled** **DEFAULT** Disables VT-d capability.
- **Enabled** Enables VT-d capability.

KINO-DH110 Mini-ITX Motherboard

5.4.1.1 Memory Configuration

Use the **Memory Configuration** submenu (**BIOS Menu 18**) to view memory information.

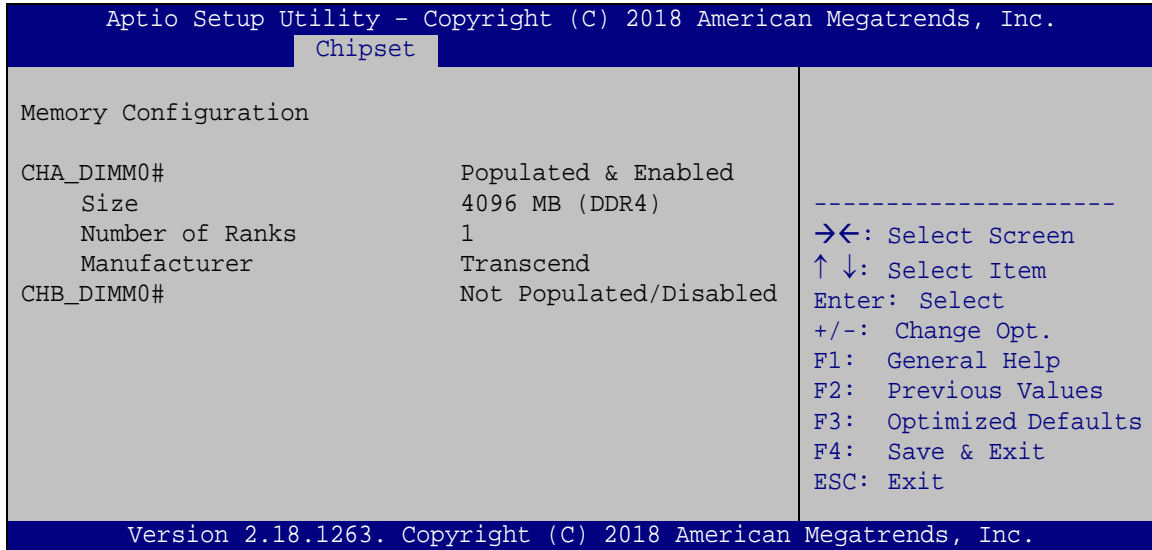

BIOS Menu 18: Memory Configuration

5.4.1.2 Graphics Configuration

Use the **Graphics Configuration (BIOS Menu 19)** menu to configure the video device connected to the system.

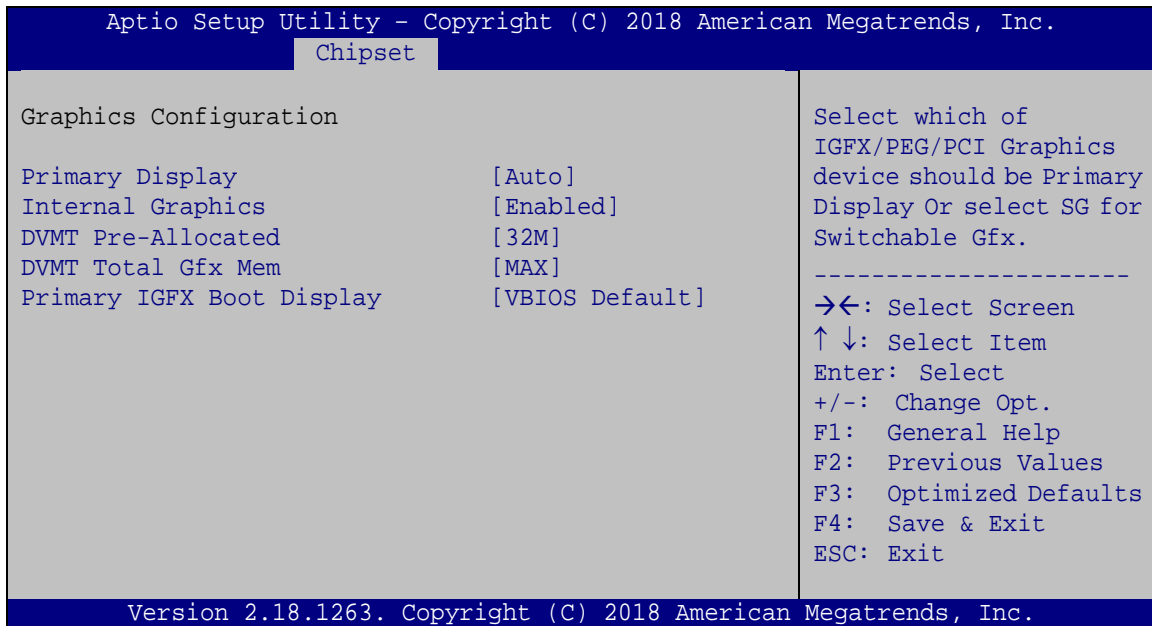

BIOS Menu 19: Graphics Configuration

→ Primary Display [Auto]

Use the **Primary Display** option to select the primary graphics controller the system uses.

The following options are available:

- Auto **Default**
- IGFX
- PEG
- PCI

→ Internal Graphics [Enabled]

Use the **Internal Graphics** option to configure whether to keep IGFX enabled. If user wants to support dual display by internal graphics and external graphics, this Internal Graphics option should be set to Enabled and the above Primary Display option should be set to IGFX.

- **Auto** Auto mode
- **Disabled** Disables IGFX.
- **Enabled** **DEFAULT** Enables IGFX.

→ DVMT Pre-Allocated [32M]

Use the **DVMT Pre-Allocated** option to set the amount of system memory allocated to the integrated graphics processor when the system boots. The system memory allocated can then only be used as graphics memory, and is no longer available to applications or the operating system. Configuration options are listed below:

- 32M **Default**
- 64M

→ DVMT Total Gfx Mem [MAX]

Use the **DVMT Total Gfx Mem** option to select DVMT5.0 total graphic memory size used by the internal graphic device. The following options are available:

- 128M
- 256M
- MAX **Default**

KINO-DH110 Mini-ITX Motherboard

→ Primary IGFX Boot Display [VBIOS Default]

Use the **Primary IGFX Boot Display** option to select the display device used by the system when it boots. Configuration options are listed below.

- VBIOS Default **Default**
- HDMI
- IDP
- DP

5.4.1.3 PEG Port Configuration

```

Aptio Setup Utility - Copyright (C) 2018 American Megatrends, Inc.
Chipset
PEG Port Configuration
PEG 0:1:0                Not Present
  Enable Root Port       [Enabled]
  Max Link Speed         [Auto]
> PEG Port Feature Configuration
Enable or Disable the Root Port
-----
→←: Select Screen
↑ ↓: Select Item
Enter: Select
+/-: Change Opt.
F1: General Help
F2: Previous Values
F3: Optimized Defaults
F4: Save & Exit
ESC: Exit
Version 2.18.1263. Copyright (C) 2018 American Megatrends, Inc.
  
```

BIOS Menu 20: PEG Port Configuration

→ Enable Root Port [Enabled]

Use the **Enable Root Port** option to enable or disable the PCI Express (PEG) controller.

- **Disabled** Disables the PCI Express (PEG) controller.
- **Enabled** **DEFAULT** Enables the PCI Express (PEG) controller.

→ Max Link Speed [Auto]

Use the **Max Link Speed** option to select the maximum link speed of the PCI Express slot. The following options are available:

- Auto **Default**
- Gen1
- Gen2
- Gen3

5.4.1.3.1 PEG Port Feature Configuration

Use the **PEG Port Feature Configuration** submenu (**BIOS Menu 21**) to configure the SA PCIe settings.

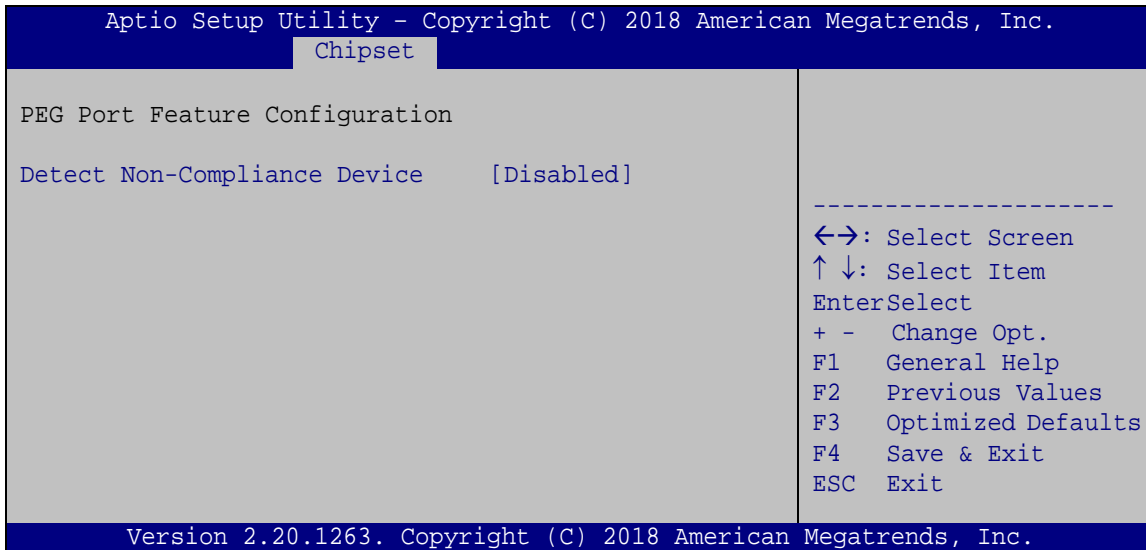

BIOS Menu 21: PEG Port Feature Configuration

→ Detect Non-Compliance Device [Disabled]

Use the **Detect Non-Compliance Device** option to enable or disable detecting if a non-compliance PCI Express device is connected to the PCI Express slot.

- **Disabled** **DEFAULT** Disables to detect if a non-compliance PCI Express device is connected to the PCI Express slot.

KINO-DH110 Mini-ITX Motherboard

- ➔ **Enabled** Enables to detect if a non-compliance PCI Express device is connected to the PCI Express slot.

5.4.2 PCH-IO Configuration

Use the **PCH-IO Configuration** menu (**BIOS Menu 22**) to configure the PCH parameters.

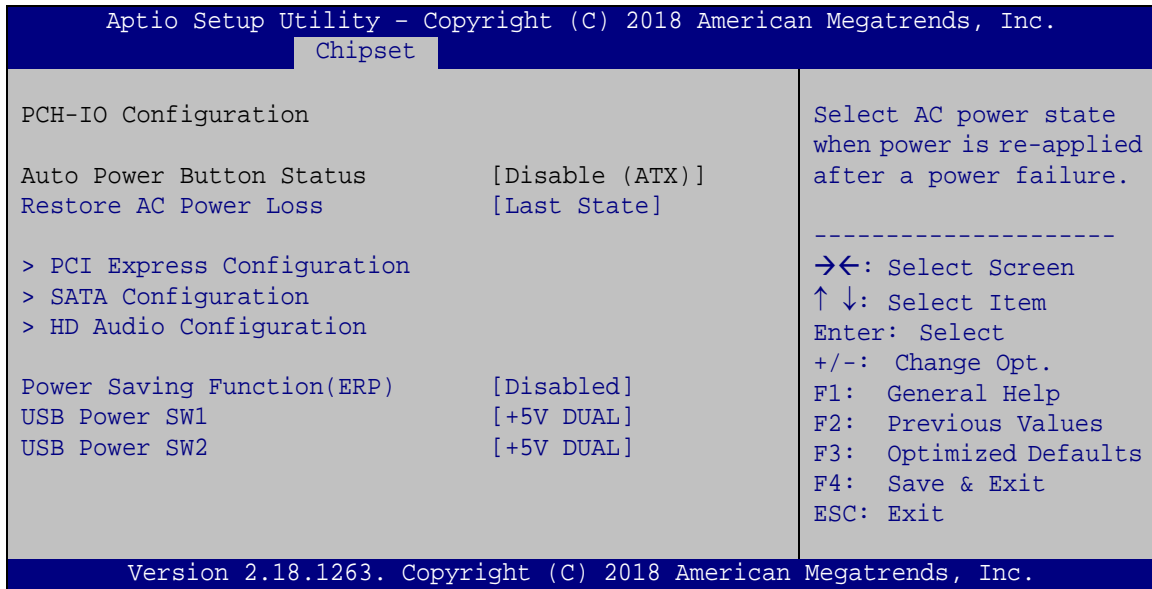

BIOS Menu 22: PCH-IO Configuration

➔ **Restore AC Power Loss [Last State]**

Use the **Restore AC Power Loss** BIOS option to specify what state the system returns to if there is a sudden loss of power to the system.

- ➔ **Power Off** The system remains turned off.
- ➔ **Power On** The system turns on.
- ➔ **Last State** **DEFAULT** The system returns to its previous state. If it was on, it turns itself on. If it was off, it remains off.

→ Power Saving Function(ERP) [Disabled]

Use the **Power Saving Function(ERP)** BIOS option to enable or disable the power saving function.

- Disabled DEFAULT** Power saving function is disabled.
- Enabled** Power saving function is enabled. It will reduce power consumption when the system is off.

→ USB Power SW1 [+5V DUAL]

Use the **USB Power SW1** BIOS option to configure whether to provide power to the four external USB 3.0 connectors when the system is in S3/S4 sleep state. This option is valid only when the above **Power Saving Function (ERP)** BIOS option is disabled.

- +5V DUAL DEFAULT** Power is not provided to the external USB 3.0 connectors when the system is in S3/S4 sleep state
- +5V** Power is provided to the external USB 3.0 connectors when the system is in S3/S4 sleep state

→ USB Power SW2 [+5V DUAL]

Use the **USB Power SW2** BIOS option to configure whether to provide power to the two external USB 2.0 connectors when the system is in S3/S4 sleep state. This option is valid only when the above **Power Saving Function (ERP)** BIOS option is disabled.

- +5V DUAL DEFAULT** Power is not provided to the external USB 2.0 connectors when the system is in S3/S4 sleep state
- +5V** Power is provided to the external USB 2.0 connectors when the system is in S3/S4 sleep state

KINO-DH110 Mini-ITX Motherboard

BIOS Options	Configured USB Ports
USB Power SW1	LAN1_USB1 (external USB 3.0 ports)
	LAN2_USB2 (external USB 3.0 ports)
USB Power SW2	USB1 (internal USB 2.0 ports)
	USB2 (internal USB 2.0 ports)

Table 5-2: BIOS Options and Configured USB Ports

5.4.2.1 PCI Express Configuration

Use the **PCI Express Configuration** submenu (**BIOS Menu 23**) to configure the PCIe Mini slot.

```

Aptio Setup Utility - Copyright (C) 2018 American Megatrends, Inc.
  Chipset
PCI Express Configuration
> MPCIE1 Slot
MPCIE1 Slot Settings.
-----
-><: Select Screen
↑ ↓: Select Item
Enter: Select
+/-: Change Opt.
F1: General Help
F2: Previous Values
F3: Optimized Defaults
F4: Save & Exit
ESC: Exit
Version 2.18.1263. Copyright (C) 2018 American Megatrends, Inc.
  
```

BIOS Menu 23: PCI Express Configuration

5.4.2.1.1 MPCIE1 Slot

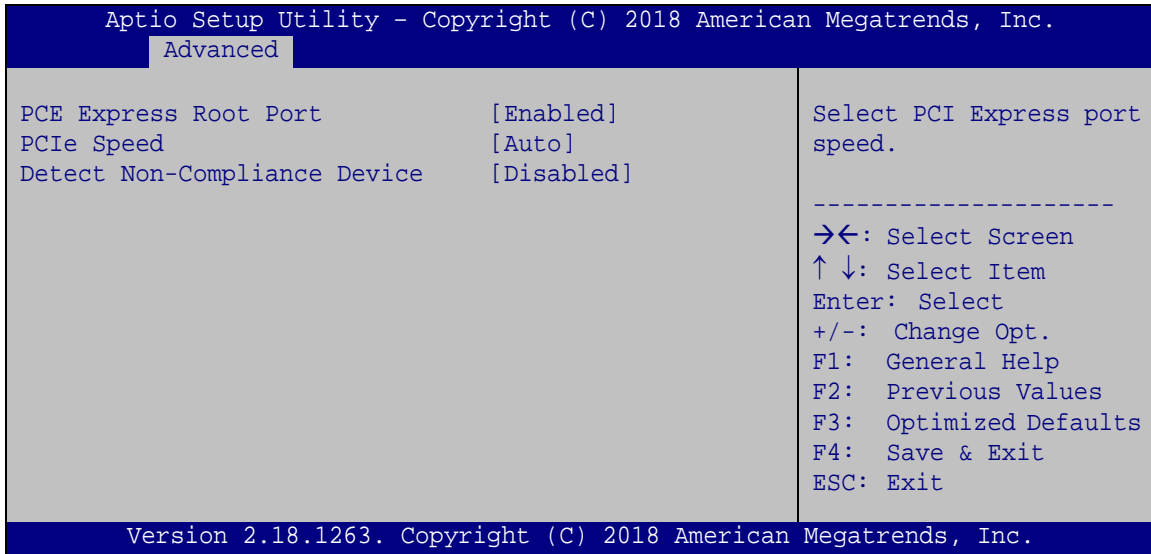

BIOS Menu 24: MPCIE1 Slot

→ PCE Express Root Port [Enabled]

Use the **PCE Express Root Port** option to enable or disable the PCI Express slot.

- **Enabled** **DEFAULT** Enables the PCI Express slot.
- **Disabled** Disables the PCI Express slot.

→ PCIe Speed [Auto]

Use this option to select the support type of the PCI Express slots. The following options are available:

- Auto **Default**
- Gen1
- Gen2
- Gen3

→ Detect Non-Compliance Device [Disabled]

Use the **Detect Non-Compliance Device** option to enable or disable detecting if a non-compliance PCI Express device is connected to the PCI Express slot.

KINO-DH110 Mini-ITX Motherboard

- ➔ **Disabled** **DEFAULT** Disables to detect if a non-compliance PCI Express device is connected to the PCI Express slot.
- ➔ **Enabled** Enables to detect if a non-compliance PCI Express device is connected to the PCI Express slot.

5.4.2.2 SATA Configuration

Use the **SATA Configuration** menu (**BIOS Menu 25**) to change and/or set the configuration of the SATA devices installed in the system.

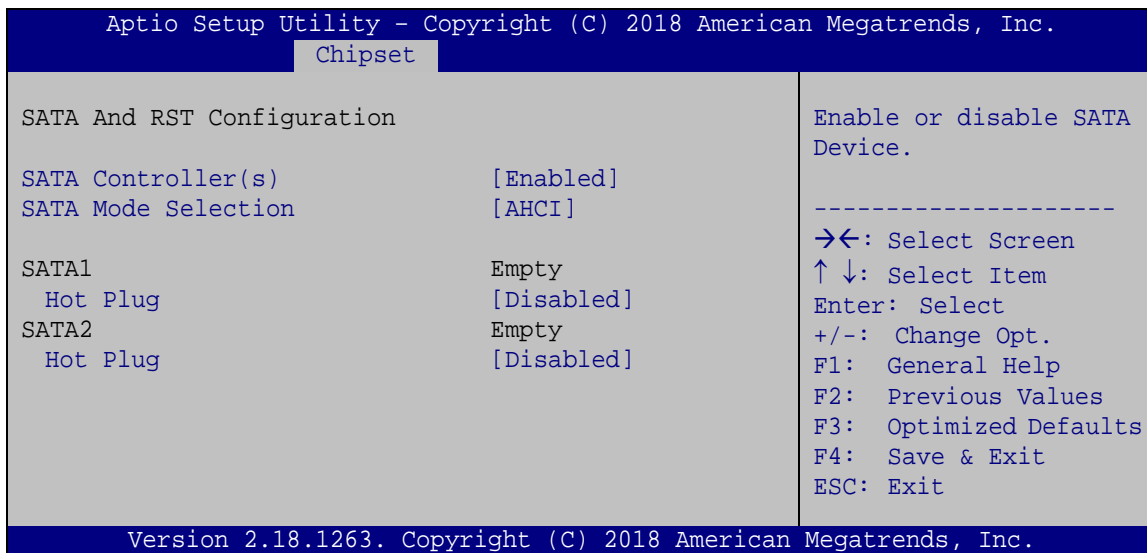

BIOS Menu 25: SATA Configuration

➔ **SATA Controller(s) [Enabled]**

Use the **SATA Controller(s)** option to configure the SATA controller(s).

- ➔ **Enabled** **DEFAULT** Enables the on-board SATA controller(s).
- ➔ **Disabled** Disables the on-board SATA controller(s).

➔ **SATA Mode Selection [AHCI]**

Use the **SATA Mode Selection** option to determine how the SATA devices operate.

- ➔ **AHCI** **DEFAULT** Configures SATA devices as AHCI device.

→ Hot Plug [Disabled]

Use the **Hot Plug** option to designate the correspondent SATA port as hot-pluggable.

- **Disabled** **DEFAULT** Disables the hot-pluggable function of the SATA port.
- **Enabled** Designates the SATA port as hot-pluggable.

5.4.2.3 HD Audio Configuration

Use the **HD Audio Configuration** menu (**BIOS Menu 26**) to configure the PCH Azalia settings.

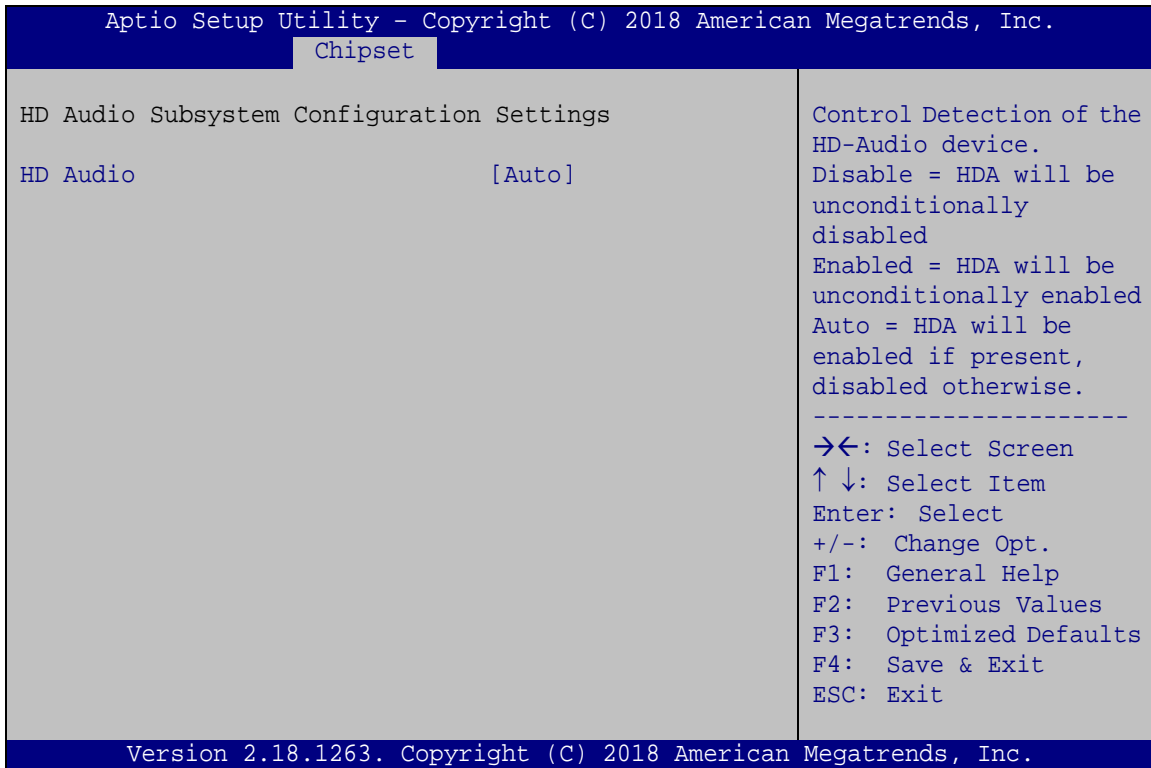

BIOS Menu 26: HD Audio Configuration

→ HD Audio [Auto]

Use the **HD Audio** option to enable or disable the High Definition Audio controller.

- **Disabled** The onboard High Definition Audio controller is disabled.
- **Enabled** The onboard High Definition Audio controller is enabled.

KINO-DH110 Mini-ITX Motherboard

- ➔ **Auto** **DEFAULT** The onboard High Definition Audio controller automatically detected and enabled

5.5 Security

Use the **Security** menu (**BIOS Menu 27**) to set system and user passwords.

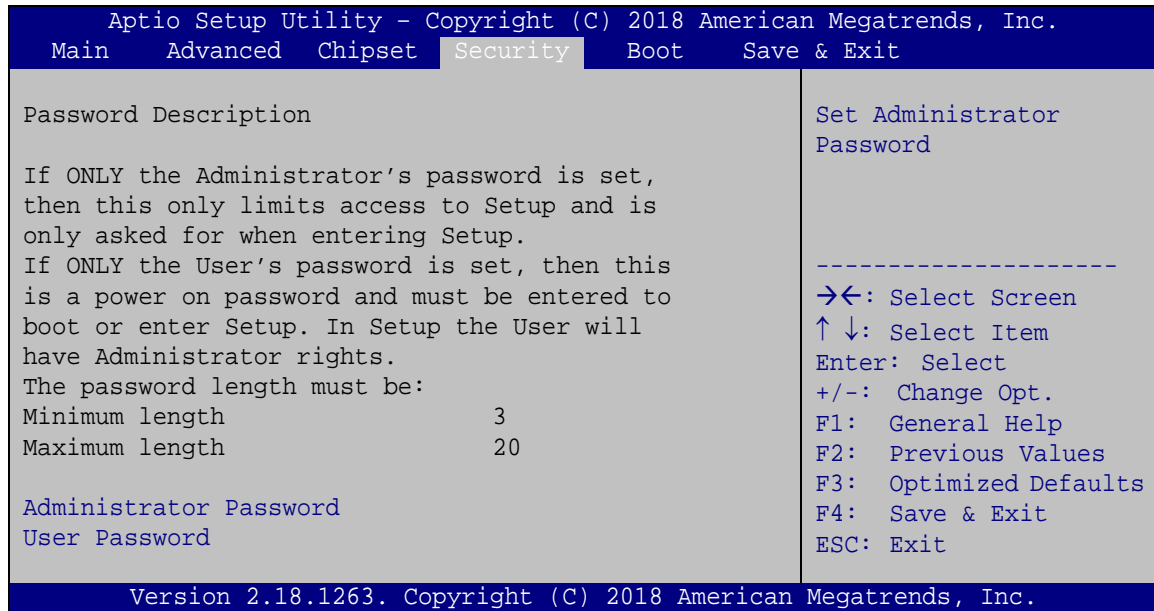

BIOS Menu 27: Security

➔ Administrator Password

Use the **Administrator Password** to set or change a administrator password.

➔ User Password

Use the **User Password** to set or change a user password.

5.6 Boot

Use the **Boot** menu (**BIOS Menu 28**) to configure system boot options.

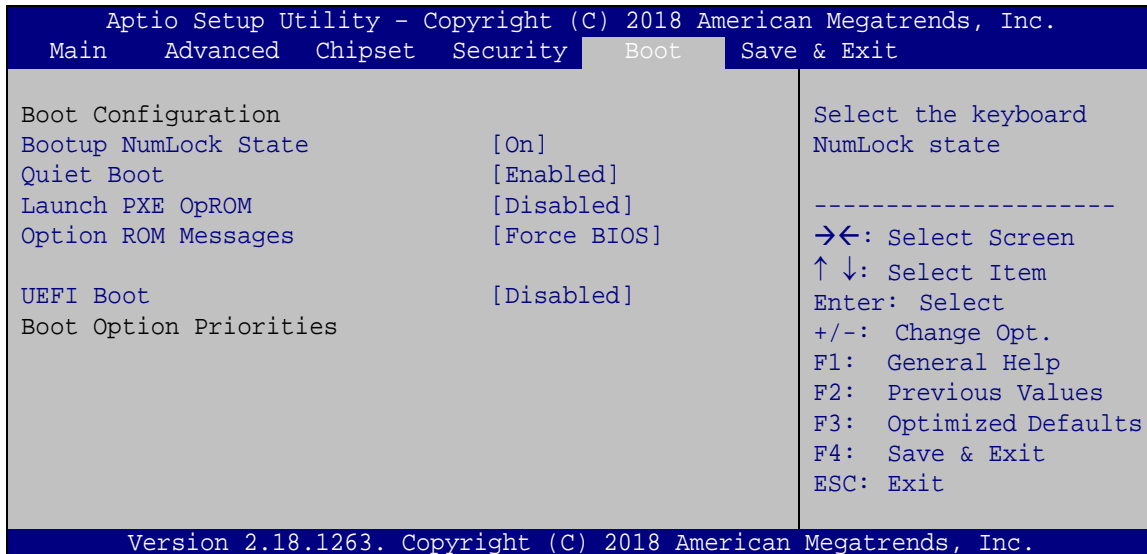

BIOS Menu 28: Boot

→ Bootup NumLock State [On]

Use the **Bootup NumLock State** BIOS option to specify if the number lock setting must be modified during boot up.

- **On** **DEFAULT** Allows the Number Lock on the keyboard to be enabled automatically when the computer system boots up. This allows the immediate use of the 10-key numeric keypad located on the right side of the keyboard. To confirm this, the Number Lock LED light on the keyboard is lit.
- **Off** Does not enable the keyboard Number Lock automatically. To use the 10-keys on the keyboard, press the Number Lock key located on the upper left-hand corner of the 10-key pad. The Number Lock LED on the keyboard lights up when the Number Lock is engaged.

KINO-DH110 Mini-ITX Motherboard

→ Quiet Boot [Enabled]

Use the **Quiet Boot** BIOS option to select the screen display when the system boots.

- **Disabled** Normal POST messages displayed
- **Enabled** **DEFAULT** OEM Logo displayed instead of POST messages

→ Launch PXE OpROM [Disabled]

Use the **Launch PXE OpROM** option to enable or disable boot option for legacy network devices.

- **Disabled** **DEFAULT** Ignore all PXE Option ROMs
- **Enabled** Load PXE Option ROMs.

→ Option ROM Messages [Force BIOS]

Use the **Option ROM Messages** option to set the Option ROM display mode.

- **Force BIOS** **DEFAULT** Sets display mode to force BIOS.
- **Keep Current** Sets display mode to current.

→ UEFI Boot [Disabled]

Use the **UEFI Boot** option to enable or disable to boot from the UEFI devices.

- **Disabled** **DEFAULT** Boot from UEFI devices is disabled.
- **Enabled** Boot from UEFI devices is enabled.

5.7 Save & Exit

Use the **Safe & Exit** menu (**BIOS Menu 29**) to load default BIOS values, optimal failsafe values and to save configuration changes.

```

Aptio Setup Utility - Copyright (C) 2018 American Megatrends, Inc.
Main   Advanced   Chipset   Security   Boot   Save & Exit
-----
Save Changes and Reset
Discard Changes and Reset

Restore Defaults
Save as User Defaults
Restore User Defaults

Exit the system after
saving the changes.

-----
-><: Select Screen
↑↓: Select Item
Enter: Select
+/-: Change Opt.
F1: General Help
F2: Previous Values
F3: Optimized Defaults
F4: Save & Exit
ESC: Exit

Version 2.18.1263. Copyright (C) 2018 American Megatrends, Inc.

```

BIOS Menu 29: Save & Exit

→ Save Changes and Reset

Use the **Save Changes and Reset** option to save the changes made to the BIOS options and reset the system.

→ Discard Changes and Reset

Use the **Discard Changes and Reset** option to exit the system without saving the changes made to the BIOS configuration setup program.

→ Restore Defaults

Use the **Restore Defaults** option to load the optimal default values for each of the parameters on the Setup menus. **F3 key can be used for this operation.**

→ Save as User Defaults

Use the **Save as User Defaults** option to save the changes done so far as user defaults.

→ Restore User Defaults

Use the **Restore User Defaults** option to restore the user defaults to all the setup options.

Appendix

A

Regulatory Compliance

DECLARATION OF CONFORMITY

This equipment has been tested and found to comply with specifications for CE marking. If the user modifies and/or installs other devices in the equipment, the CE conformity declaration may no longer apply.

FCC WARNING

This equipment complies with Part 15 of the FCC Rules. Operation is subject to the following two conditions:

- This device may not cause harmful interference, and
- This device must accept any interference received, including interference that may cause undesired operation.

This equipment has been tested and found to comply with the limits for a Class A digital device, pursuant to part 15 of the FCC Rules. These limits are designed to provide reasonable protection against harmful interference when the equipment is operated in a commercial environment. This equipment generates, uses, and can radiate radio frequency energy and, if not installed and used in accordance with the instruction manual, may cause harmful interference to radio communications. Operation of this equipment in a residential area is likely to cause harmful interference in which case the user will be required to correct the interference at his own expense.

Appendix

B

Product Disposal

**CAUTION:**

Risk of explosion if battery is replaced by an incorrect type. Only certified engineers should replace the on-board battery.

Dispose of used batteries according to instructions and local regulations.

- Outside the European Union–If you wish to dispose of used electrical and electronic products outside the European Union, please contact your local authority so as to comply with the correct disposal method.
- Within the European Union–The device that produces less waste and is easier to recycle is classified as electronic device in terms of the European Directive 2012/19/EU (WEEE), and must not be disposed of as domestic garbage.

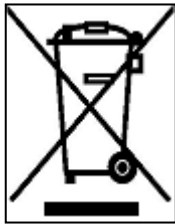

EU-wide legislation, as implemented in each Member State, requires that waste electrical and electronic products carrying the mark (left) must be disposed of separately from normal household waste. This includes monitors and electrical accessories, such as signal cables or power cords. When you need to dispose of your device, please follow the guidance of your local authority, or ask the shop where you purchased the product. The mark on electrical and electronic products only applies to the current European Union Member States.

Please follow the national guidelines for electrical and electronic product disposal.

Appendix

C

BIOS Options

Below is a list of BIOS configuration options in the BIOS chapter.

<input type="checkbox"/>	System Date [xx/xx/xx]	76
<input type="checkbox"/>	System Time [xx:xx:xx]	76
<input type="checkbox"/>	Intel (VMX) Virtualization Technology [Disabled]	77
<input type="checkbox"/>	Active Processor Cores [All]	77
<input type="checkbox"/>	Intel(R) SpeedStep(tm) [Enabled]	78
<input type="checkbox"/>	C States [Disabled]	78
<input type="checkbox"/>	Unconfigure ME [Disabled]	79
<input type="checkbox"/>	ACPI Sleep State [S3 (Suspend to RAM)]	80
<input type="checkbox"/>	Case Open Detection [Disabled]	81
<input type="checkbox"/>	Serial Port [Enabled]	82
<input type="checkbox"/>	Change Settings [Auto]	82
<input type="checkbox"/>	Transfer Mode [RS232]	83
<input type="checkbox"/>	Serial Port [Enabled]	83
<input type="checkbox"/>	Change Settings [Auto]	83
<input type="checkbox"/>	Serial Port [Enabled]	84
<input type="checkbox"/>	Change Settings [Auto]	84
<input type="checkbox"/>	PC Health Status	85
<input type="checkbox"/>	CPU_FAN1 Smart Fan Control/SYS_FAN1 Smart Fan Control [Auto Mode]	86
<input type="checkbox"/>	Auto mode fan start/off temperature	86
<input type="checkbox"/>	Auto mode fan start PWM	86
<input type="checkbox"/>	Auto mode fan slope PWM	87
<input type="checkbox"/>	Wake system with Fixed Time [Disabled]	87
<input type="checkbox"/>	Console Redirection [Disabled]	89
<input type="checkbox"/>	Terminal Type [ANSI]	89
<input type="checkbox"/>	Bits per second [115200]	89
<input type="checkbox"/>	Data Bits [8]	89
<input type="checkbox"/>	Parity [None]	90
<input type="checkbox"/>	Stop Bits [1]	90
<input type="checkbox"/>	Legacy Serial Redirection Port [COM1]	91
<input type="checkbox"/>	Legacy USB Support [Enabled]	93
<input type="checkbox"/>	Auto Recovery Function [Disabled]	94
<input type="checkbox"/>	VT-d [Disabled]	96
<input type="checkbox"/>	Primary Display [Auto]	98

KINO-DH110 Mini-ITX Motherboard

<input type="checkbox"/>	Internal Graphics [Enabled]	98
<input type="checkbox"/>	DVMT Pre-Allocated [32M]	98
<input type="checkbox"/>	DVMT Total Gfx Mem [MAX]	98
<input type="checkbox"/>	Primary IGFX Boot Display [VBIOS Default]	99
<input type="checkbox"/>	Enable Root Port [Enabled]	99
<input type="checkbox"/>	Max Link Speed [Auto]	100
<input type="checkbox"/>	Detect Non-Compliance Device [Disabled]	100
<input type="checkbox"/>	Restore AC Power Loss [Last State]	101
<input type="checkbox"/>	Power Saving Function(ERP) [Disabled]	102
<input type="checkbox"/>	USB Power SW1 [+5V DUAL]	102
<input type="checkbox"/>	USB Power SW2 [+5V DUAL]	102
<input type="checkbox"/>	PCE Express Root Port [Enabled]	104
<input type="checkbox"/>	PCIe Speed [Auto]	104
<input type="checkbox"/>	Detect Non-Compliance Device [Disabled]	104
<input type="checkbox"/>	SATA Controller(s) [Enabled]	105
<input type="checkbox"/>	SATA Mode Selection [AHCI]	105
<input type="checkbox"/>	Hot Plug [Disabled]	106
<input type="checkbox"/>	HD Audio [Auto]	106
<input type="checkbox"/>	Administrator Password	107
<input type="checkbox"/>	User Password	107
<input type="checkbox"/>	Bootup NumLock State [On]	108
<input type="checkbox"/>	Quiet Boot [Enabled]	109
<input type="checkbox"/>	Launch PXE OpROM [Disabled]	109
<input type="checkbox"/>	Option ROM Messages [Force BIOS]	109
<input type="checkbox"/>	UEFI Boot [Disabled]	109
<input type="checkbox"/>	Save Changes and Reset	110
<input type="checkbox"/>	Discard Changes and Reset	110
<input type="checkbox"/>	Restore Defaults	110
<input type="checkbox"/>	Save as User Defaults	110
<input type="checkbox"/>	Restore User Defaults	110

Appendix

D

Digital I/O Interface

KINO-DH110 Mini-ITX Motherboard

D.1 Introduction

The DIO connector on the KINO-DH110 is interfaced to GPIO ports on the Super I/O chipset. The DIO has both 4-bit digital inputs and 4-bit digital outputs. The digital inputs and digital outputs are generally control signals that control the on/off circuit of external devices or TTL devices. Data can be read or written to the selected address to enable the DIO functions.



NOTE:

For further information, please refer to the datasheet for the Super I/O chipset.

The BIOS interrupt call **INT 15H** controls the digital I/O.

INT 15H:

AH – 6FH	
<u>Sub-function:</u>	
AL – 8	: Set the digital port as INPUT
AL	: Digital I/O input value

D.2 Assembly Language Sample 1

```
MOV     AX, 6F08H      ;setting the digital port as input
INT     15H           ;
```

AL low byte = value

AH – 6FH
Sub-function:
AL – 9 : Set the digital port as OUTPUT
BL : Digital I/O input value

D.3 Assembly Language Sample 2

```
MOV     AX, 6F09H      ;setting the digital port as output
MOV     BL, 09H        ;digital value is 09H
INT     15H           ;
```

Digital Output is 1001b

Appendix

E

Watchdog Timer



NOTE:

The following discussion applies to DOS environment. Contact IEI support or visit the IEI website for specific drivers for other operating systems.

The Watchdog Timer is provided to ensure that standalone systems can always recover from catastrophic conditions that cause the CPU to crash. This condition may have occurred by external EMIs or a software bug. When the CPU stops working correctly, Watchdog Timer either performs a hardware reset (cold boot) or a Non-Maskable Interrupt (NMI) to bring the system back to a known state.

A BIOS function call (INT 15H) is used to control the Watchdog Timer.

INT 15H:

AH – 6FH Sub-function:	
AL – 2:	Sets the Watchdog Timer's period.
BL:	Time-out value (Its unit-second is dependent on the item "Watchdog Timer unit select" in CMOS setup).

Table E-1: AH-6FH Sub-function

Call sub-function 2 to set the time-out period of Watchdog Timer first. If the time-out value is not zero, the Watchdog Timer starts counting down. When the timer value reaches zero, the system resets. To ensure that this reset condition does not occur, calling sub-function 2 must periodically refresh the Watchdog Timer. However, the watchdog timer is disabled if the time-out value is set to zero.

A tolerance of at least 10% must be maintained to avoid unknown routines within the operating system (DOS), such as disk I/O that can be very time-consuming.

KINO-DH110 Mini-ITX Motherboard

**NOTE:**

When exiting a program it is necessary to disable the Watchdog Timer, otherwise the system resets.

EXAMPLE PROGRAM:

; INITIAL TIMER PERIOD COUNTER

;

W_LOOP:

;

```

MOV      AX, 6F02H      ;setting the time-out value
MOV      BL, 30         ;time-out value is 48 seconds
INT      15H

```

;

; ADD THE APPLICATION PROGRAM HERE

;

```

CMP      EXIT_AP, 1     ;is the application over?
JNE      W_LOOP        ;No, restart the application

```

```

MOV      AX, 6F02H      ;disable Watchdog Timer
MOV      BL, 0          ;
INT      15H

```

;

; EXIT ;

Appendix

F

Hazardous Materials Disclosure

KINO-DH110 Mini-ITX Motherboard

The details provided in this appendix are to ensure that the product is compliant with the Peoples Republic of China (China) RoHS standards. The table below acknowledges the presences of small quantities of certain materials in the product, and is applicable to China RoHS only.

A label will be placed on each product to indicate the estimated “Environmentally Friendly Use Period” (EFUP). This is an estimate of the number of years that these substances would “not leak out or undergo abrupt change.” This product may contain replaceable sub-assemblies/components which have a shorter EFUP such as batteries and lamps. These components will be separately marked.

Please refer to below table.

Part Name	Toxic or Hazardous Substances and Elements					
	Lead (Pb)	Mercury (Hg)	Cadmium (Cd)	Hexavalent Chromium (CR(VI))	Polybrominated Biphenyls (PBB)	Polybrominated Diphenyl Ethers (PBDE)
Housing	O	O	O	O	O	O
Display	O	O	O	O	O	O
Printed Circuit Board	O	O	O	O	O	O
Metal Fasteners	O	O	O	O	O	O
Cable Assembly	O	O	O	O	O	O
Fan Assembly	O	O	O	O	O	O
Power Supply Assemblies	O	O	O	O	O	O
Battery	O	O	O	O	O	O

O: This toxic or hazardous substance is contained in all of the homogeneous materials for the part is below the limit requirement in SJ/T11363-2006 (now replaced by GB/T 26572-2011).

X: This toxic or hazardous substance is contained in at least one of the homogeneous materials for this part is above the limit requirement in SJ/T11363-2006 (now replaced by GB/T 26572-2011).

此附件旨在确保本产品符合中国 RoHS 标准。以下表格标示此产品中某有毒物质的含量符合中国 RoHS 标准规定的限量要求。

本产品上会附有“环境友好使用期限”的标签，此期限是估算这些物质“不会有泄漏或突变”的年限。本产品可能包含有较短的环境友好使用期限的可替换元件，像是电池或灯管，这些元件将会单独标示出来。

部件名称	有毒有害物质或元素					
	铅 (Pb)	汞 (Hg)	镉 (Cd)	六价铬 (CR(VI))	多溴联苯 (PBB)	多溴二苯 醚 (PBDE)
壳体	○	○	○	○	○	○
显示	○	○	○	○	○	○
印刷电路板	○	○	○	○	○	○
金属螺帽	○	○	○	○	○	○
电缆组装	○	○	○	○	○	○
风扇组装	○	○	○	○	○	○
电力供应组装	○	○	○	○	○	○
电池	○	○	○	○	○	○

○: 表示该有毒有害物质在该部件所有物质材料中的含量均在 SJ/T 11363-2006 (现由 GB/T 26572-2011 取代) 标准规定的限量要求以下。

X: 表示该有毒有害物质至少在该部件的某一均质材料中的含量超出 SJ/T 11363-2006 (现由 GB/T 26572-2011 取代) 标准规定的限量要求。