

MODEL:
KINO-DBT Series

**Mini-ITX SBC with 22nm Intel® Atom™ or Celeron® SoC,
Dual GbE, DDR3, DVI, VGA, DisplayPort, USB 3.0,
RS-232/422/485, SATA 3Gb/s, and RoHS**

User Manual

Revision

Date	Version	Changes
March 1, 2017	1.02	Modified the part number and image of the optional keyboard/mouse cable in Section 2.4.
February 16, 2016	1.01	Clarified memory specifications
January 8, 2015	1.00	Initial release

Copyright

COPYRIGHT NOTICE

The information in this document is subject to change without prior notice in order to improve reliability, design and function and does not represent a commitment on the part of the manufacturer.

In no event will the manufacturer be liable for direct, indirect, special, incidental, or consequential damages arising out of the use or inability to use the product or documentation, even if advised of the possibility of such damages.

This document contains proprietary information protected by copyright. All rights are reserved. No part of this manual may be reproduced by any mechanical, electronic, or other means in any form without prior written permission of the manufacturer.

TRADEMARKS

All registered trademarks and product names mentioned herein are used for identification purposes only and may be trademarks and/or registered trademarks of their respective owners.

Manual Conventions



WARNING

Warnings appear where overlooked details may cause damage to the equipment or result in personal injury. Warnings should be taken seriously.



CAUTION

Cautionary messages should be heeded to help reduce the chance of losing data or damaging the product.



NOTE

These messages inform the reader of essential but non-critical information. These messages should be read carefully as any directions or instructions contained therein can help avoid making mistakes.



HOT SURFACE

This symbol indicates a hot surface that should not be touched without taking care.

Table of Contents

1 INTRODUCTION.....	1
1.1 INTRODUCTION.....	2
1.2 MODEL VARIATIONS	3
1.3 BENEFITS	4
1.4 FEATURES.....	4
1.5 CONNECTORS	5
1.6 DIMENSIONS.....	6
1.7 DATA FLOW	7
1.8 TECHNICAL SPECIFICATIONS	8
2 PACKING LIST.....	11
2.1 ANTI-STATIC PRECAUTIONS	12
2.2 UNPACKING PRECAUTIONS.....	12
2.3 PACKING LIST.....	13
2.4 OPTIONAL ITEMS	14
3 CONNECTORS	16
3.1 PERIPHERAL INTERFACE CONNECTORS.....	17
3.1.1 KINO-DBT Layout.....	17
3.1.2 Peripheral Interface Connectors	18
3.1.3 External Interface Panel Connectors.....	19
3.2 INTERNAL PERIPHERAL CONNECTORS	20
3.2.1 Audio Connector	20
3.2.2 Battery Connector.....	21
3.2.3 Chassis Intrusion Connector.....	22
3.2.4 Digital I/O Connector.....	22
3.2.5 DisplayPort Connector	23
3.2.6 EC Debug Connector.....	24
3.2.7 Fan Connector (CPU).....	25
3.2.8 Fan Connector (System)	26

3.2.9 Front Panel Connector	27
3.2.10 Keyboard and Mouse Connector	28
3.2.11 LAN LED Connectors.....	29
3.2.12 Memory Card Slot(s).....	30
3.2.13 PCIe x4 Slot	31
3.2.14 PCIe Mini Card Slot	31
3.2.15 Power Button	33
3.2.16 Power Connector	33
3.2.17 Reset Button Connector	34
3.2.18 SATA 3Gb/s Drive Connectors.....	35
3.2.19 SATA Power Connectors	36
3.2.20 Serial Port Connectors, RS-232.....	37
3.2.21 Serial Port Connector, RS-422/485.....	38
3.2.22 SMBus Connector	40
3.2.23 SPDIF Connector.....	41
3.2.24 SPI Flash Connector.....	41
3.2.25 SPI Flash Connector, EC	42
3.2.26 TPM Connector.....	43
3.2.27 USB 2.0 Connectors.....	44
3.3 EXTERNAL PERIPHERAL INTERFACE CONNECTOR PANEL	46
3.3.1 Audio Connector	46
3.3.2 DVI Connector.....	47
3.3.3 Ethernet and USB 2.0 Combo Connector.....	48
3.3.4 Ethernet and USB 3.0 Combo Connector.....	49
3.3.5 Serial Port Connectors (COM1 and COM2).....	50
3.3.6 VGA Connector.....	51
4 INSTALLATION	53
4.1 ANTI-STATIC PRECAUTIONS	54
4.2 INSTALLATION CONSIDERATIONS.....	54
4.2.1 SO-DIMM Installation.....	56
4.2.2 PCIe Mini Card Installation	56
4.3 SYSTEM CONFIGURATION.....	58
4.3.1 AT/ATX Power Mode Setting	58
4.3.2 Clear CMOS Button.....	58

KINO-DBT Mini-ITX SBC

4.3.3	<i>Flash Descriptor Security Override</i>	59
4.3.4	<i>mSATA/SATA Selection</i>	59
4.3.5	<i>USB Power Select</i>	60
4.4	INTERNAL PERIPHERAL DEVICE CONNECTIONS	60
4.4.1	<i>SATA Drive Connection</i>	60
4.4.2	<i>USB Cable Connection</i>	61
5	BIOS	63
5.1	INTRODUCTION	64
5.1.1	<i>Starting Setup</i>	64
5.1.2	<i>Using Setup</i>	64
5.1.3	<i>Getting Help</i>	65
5.1.4	<i>Unable to Reboot after Configuration Changes</i>	65
5.1.5	<i>BIOS Menu Bar</i>	65
5.2	MAIN	66
5.3	ADVANCED	68
5.3.1	<i>ACPI Settings</i>	68
5.3.2	<i>Super IO Configuration</i>	70
5.3.2.1	<i>Serial Port n Configuration</i>	70
5.3.3	<i>iWDD Hardware Monitor</i>	78
5.3.3.1	<i>Smart Fan Mode Configuration</i>	80
5.3.4	<i>RTC Wake Settings</i>	82
5.3.5	<i>Serial Port Console Redirection</i>	83
5.3.6	<i>CPU Configuration</i>	85
5.3.7	<i>IDE Configuration</i>	88
5.3.8	<i>Trusted Computing</i>	89
5.3.9	<i>USB Configuration</i>	90
5.4	CHIPSET	91
5.4.1	<i>North Bridge</i>	92
5.4.1.1	<i>Intel IGD Configuration</i>	92
5.4.2	<i>South Bridge</i>	94
5.4.2.1	<i>Azalia HD Audio</i>	96
5.4.2.2	<i>PCI Express Configuration</i>	97
5.5	SECURITY	98
5.6	BOOT	99

5.7 EXIT	101
6 SOFTWARE DRIVERS	103
6.1 AVAILABLE SOFTWARE DRIVERS	104
6.2 SOFTWARE INSTALLATION	104
A REGULATORY COMPLIANCE	106
B PRODUCT DISPOSAL	108
C BIOS OPTIONS	110
D TERMINOLOGY	113
E DIGITAL I/O INTERFACE	118
F WATCHDOG TIMER	121
G HAZARDOUS MATERIALS DISCLOSURE	124

List of Figures

Figure 1-1: KINO-DBT Series.....	2
Figure 1-2: Connectors	5
Figure 1-3: KINO-DBT Series Main Dimensions (mm)	6
Figure 1-4: Data Flow Diagram.....	7
Figure 3-1: Connectors and Jumpers.....	17
Figure 3-2: Audio Connector Location	20
Figure 3-3: Battery Connector Location.....	21
Figure 3-4: Chassis Intrusion Connector Location.....	22
Figure 3-5: Digital I/O Connector Location	23
Figure 3-6: DisplayPort Connector Location	24
Figure 3-7: EC Debug Connector Location.....	25
Figure 3-8: CPU Fan Connector Location	26
Figure 3-9: System Fan Connector Location.....	26
Figure 3-10: Front Panel Connector Location	27
Figure 3-11: Keyboard and Mouse Connector Location.....	28
Figure 3-12: LAN LED Connector Locations	29
Figure 3-13: Memory Card Slot Locations	30
Figure 3-14: PCIe x4 Slot Location	31
Figure 3-15: PCIe Mini Card Slot Location.....	32
Figure 3-16: Power Button Location.....	33
Figure 3-17: Power Connector Location	34
Figure 3-18: Reset Button Connector Location.....	35
Figure 3-19: SATA 3Gb/s Drive Connector Locations	36
Figure 3-20: SATA Power Connector Locations	37
Figure 3-21: RS-232 Serial Port Connector Locations.....	38
Figure 3-22: RS-422/485 Connector Location.....	39
Figure 3-23: SMBus Connector Location	40
Figure 3-24: SPDIF Connector Location	41
Figure 3-25: SPI Flash Connector Location.....	42
Figure 3-26: SPI EC Flash Connector Location.....	43

Figure 3-27: TPM Connector Location.....	44
Figure 3-28: USB 2.0 Connector Locations	45
Figure 3-29: External Peripheral Interface Connector	46
Figure 3-30: Audio Connector	47
Figure 3-31: DVI-I Connector	48
Figure 3-32: Ethernet Connector.....	48
Figure 3-33: Ethernet Connector.....	50
Figure 3-34: Serial Port Pinouts	51
Figure 3-35: VGA Connector	52
Figure 4-1: SO-DIMM Installation	56
Figure 4-2: PCIe Mini Card Retention Screw Removal	57
Figure 4-3: PCIe Mini Card Installation (Full-size).....	57
Figure 4-4: AT/ATX Power Mode Switch Location	58
Figure 4-5: Clear CMOS Button Location.....	58
Figure 4-6: Flash Descriptor Security Override Jumper Location	59
Figure 4-7: mSATA/SATA Switch Location.....	60
Figure 4-8: SATA Drive Cable Connection.....	61
Figure 4-9: Dual USB Cable Connection	62
Figure 6-1: Available Drivers	105

List of Tables

Table 1-1: Model Variations	3
Table 1-2: KINO-DBT Series Specifications	10
Table 2-1: Packing List.....	13
Table 3-1: Peripheral Interface Connectors	19
Table 3-2: Rear Panel Connectors	19
Table 3-3: Audio Connector Pinouts	20
Table 3-4: Battery Connector Pinouts	21
Table 3-5: Chassis Intrusion Connector Pinouts	22
Table 3-6: Digital I/O Connector Pinouts.....	23
Table 3-7: DisplayPort Connector Pinouts	24
Table 3-8: EC Debug Connector Pinouts	25
Table 3-9: CPU Fan Connector Pinouts.....	26
Table 3-10: System Fan Connector Pinouts	27
Table 3-11: Front Panel Connector Pinouts.....	28
Table 3-12: Keyboard and Mouse Connector Pinouts	29
Table 3-13: LAN1 LED Connector Pinouts	29
Table 3-14: LAN2 LED Connector Pinouts	30
Table 3-15: PCIe Mini Card Slot Pinouts	33
Table 3-16: Power Connector Pinouts.....	34
Table 3-17: Reset Button Connector Pinouts	35
Table 3-18: SATA 3Gb/s Drive Connector Pinouts.....	36
Table 3-19: SATA Power Connector Pinouts.....	37
Table 3-20: RS-232 Serial Port Connector Pinouts	38
Table 3-21: RS-422/485 Connector Pinouts	39
Table 3-22: RS-422/485 Pinouts of D-sub 9 Connector.....	39
Table 3-23: SMBus Connector Pinouts	40
Table 3-24: SPDIF Connector Pinouts	41
Table 3-25: SPI Flash Connector Pinouts	42
Table 3-26: SPI EC Flash Connector Pinouts	43
Table 3-27: TPM Connector Pinouts	44

Table 3-28: USB1 Pinouts	45
Table 3-29: USB2 Pinouts	45
Table 3-30: DVI Connector Pinouts.....	48
Table 3-31: LAN2 Ethernet Connector Pinouts	48
Table 3-32: Connector LEDs.....	49
Table 3-33: USB 2.0 Port Pinouts.....	49
Table 3-34: LAN1 Ethernet Connector Pinouts	49
Table 3-35: Connector LEDs.....	50
Table 3-36: USB 3.0 Port Pinouts.....	50
Table 3-37: Serial Port Pinouts.....	51
Table 3-38: VGA Connector Pinouts.....	52
Table 4-1: Flash Descriptor Security Override Jumper Settings.....	59
Table 4-2: mSATA/SATA Switch Settings	59
Table 4-3: BIOS Options and Configured USB Ports.....	60
Table 5-1: BIOS Navigation Keys	65
Table 5-2: BIOS Options and Configured USB Ports.....	95

BIOS Menus

BIOS Menu 1: Main	66
BIOS Menu 2: Advanced	68
BIOS Menu 3: ACPI Configuration	69
BIOS Menu 4: Super IO Configuration.....	70
BIOS Menu 5: Serial Port n Configuration Menu.....	70
BIOS Menu 6: iWDD Hardware Monitor	79
BIOS Menu 7: Smart Fan Function	80
BIOS Menu 8: RTC Wake Settings	82
BIOS Menu 9: Serial Port Console Redirection	83
BIOS Menu 10: CPU Configuration	86
BIOS Menu 11: IDE Configuration.....	88
BIOS Menu 12: Trusted Computing.....	89
BIOS Menu 13: USB Configuration	90
BIOS Menu 14: Chipset	91
BIOS Menu 15: North Bridge	92
BIOS Menu 16: Intel IGD Configuration.....	92
BIOS Menu 17: South Bridge.....	94
BIOS Menu 18: Azalia HD Audio	96
BIOS Menu 19: PCI Express Configuration	97
BIOS Menu 20: Security	98
BIOS Menu 21: Boot	99
BIOS Menu 22:Exit.....	101

Chapter

1

Introduction

1.1 Introduction

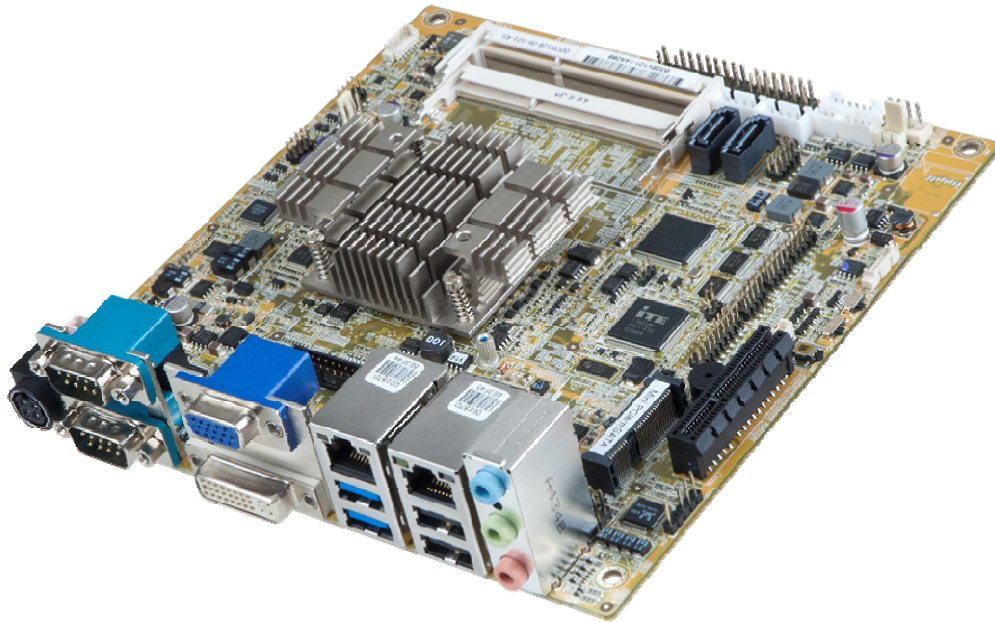

Figure 1-1: KINO-DBT Series

The KINO-DBT series is a Mini-ITX form factor single board computer. It has an on-board 22nm Intel® Atom™ or Celeron® processor, and supports one/two 204-pin 1333/1066 MHz dual-channel unbuffered DDR3 Low Voltage (DDR3L) SDRAM SO-DIMM with up to 4.0 GB / 8.0 GB of memory.

The KINO-DBT series includes one VGA port and one DVI port for dual independent display. It also has an internal DisplayPort (iDP) connector supporting HDMI, DVI, VGA, LVDS and DP monitors through the IEI converter boards. Expansion and I/O include one PCIe x4 slot (with PCIe x1 signal), one PCIe Mini slot supporting mSATA modules, two USB 3.0 ports plus two USB 2.0 on the rear panel, four USB 2.0 by pin header, two SATA 3Gb/s connectors, five RS-232 serial ports, and one RS-422/485 connector.

KINO-DBT Mini-ITX SBC

1.2 Model Variations

There are eight models of the KINO-DBT series. The model variations are listed in **Table 1-1**.

Model	On-board SoC	Memory	microSD
Standard			
KINO-DBT-J19001	Intel® Celeron® processor J1900 (2 GHz, quad-core, 2 MB cache)	2 x SO-DIMM slots Size: 8 GB (max.)	No
KINO-DBT-N29301	Intel® Celeron® processor N2930 (1.83 GHz, quad-core, 2 MB cache)	2 x SO-DIMM slots Size: 8 GB (max.)	No
KINO-DBT-N28071	Intel® Celeron® processor N2807 (1.58 GHz, dual-core, 2 MB cache)	1 x SO-DIMM slot Size: 4 GB (max.)	No
By Request			
KINO-DBT-E38451	Intel® Atom™ processor E3845 (1.91 GHz, quad-core, 2 MB cache)	2 x SO-DIMM slots Size: 8 GB (max.)	Yes
KINO-DBT-E38271	Intel® Atom™ processor E3827 (1.75 GHz, dual-core, 1 MB cache)	2 x SO-DIMM slots Size: 8 GB (max.)	Yes
KINO-DBT-E38261	Intel® Atom™ processor E3826 (1.46 GHz, dual-core, 1 MB cache)	2 x SO-DIMM slots Size: 8 GB (max.)	Yes
KINO-DBT-E38251	Intel® Atom™ processor E3825 (1.33 GHz, dual-core, 1 MB cache)	1 x SO-DIMM slot Size: 4 GB (max.)	Yes
KINO-DBT-E38151	Intel® Atom™ processor E3815 (1.46 GHz, single-core, 512 KB cache)	1 x SO-DIMM slot Size: 4 GB (max.)	Yes

Table 1-1: Model Variations

1.3 Benefits

Some of the KINO-DBT series motherboard benefits include:

- Powerful graphics with multiple monitors
- Staying connected with both wired LAN connections
- Speedy running of multiple programs and applications

1.4 Features

Some of the KINO-DBT series motherboard features are listed below:

- Mini-ITX form factor
- RoHS compliant
- On-board 22nm Intel® Atom™ or Celeron® processor
- Two 204-pin 1333/1066 MHz dual-channel unbuffered DDR3L SDRAM SO-DIMM slots support up to 8 GB of memory (for J1900, N2930, E3845, E3827 and E3826 SKUs)
or
One 204-pin 1333/1066 MHz unbuffered DDR3L SDRAM SO-DIMM slot supports up to 4 GB of memory (for N2807, E3825 and E3815 SKUs)
- iDP, VGA and DVI interfaces for dual independent display
- Two GbE connectors
- Two SATA 3Gb/s connectors
- One PCIe Mini card expansion slot
- One PCIe x4 (x1 mode) expansion slot
- Two USB 3.0 ports and six USB 2.0 ports
- Five RS-232 serial ports and one RS-422/485 serial port
- High Definition Audio

KINO-DBT Mini-ITX SBC

1.5 Connectors

The connectors on the KINO-DBT series are shown in the figure below.

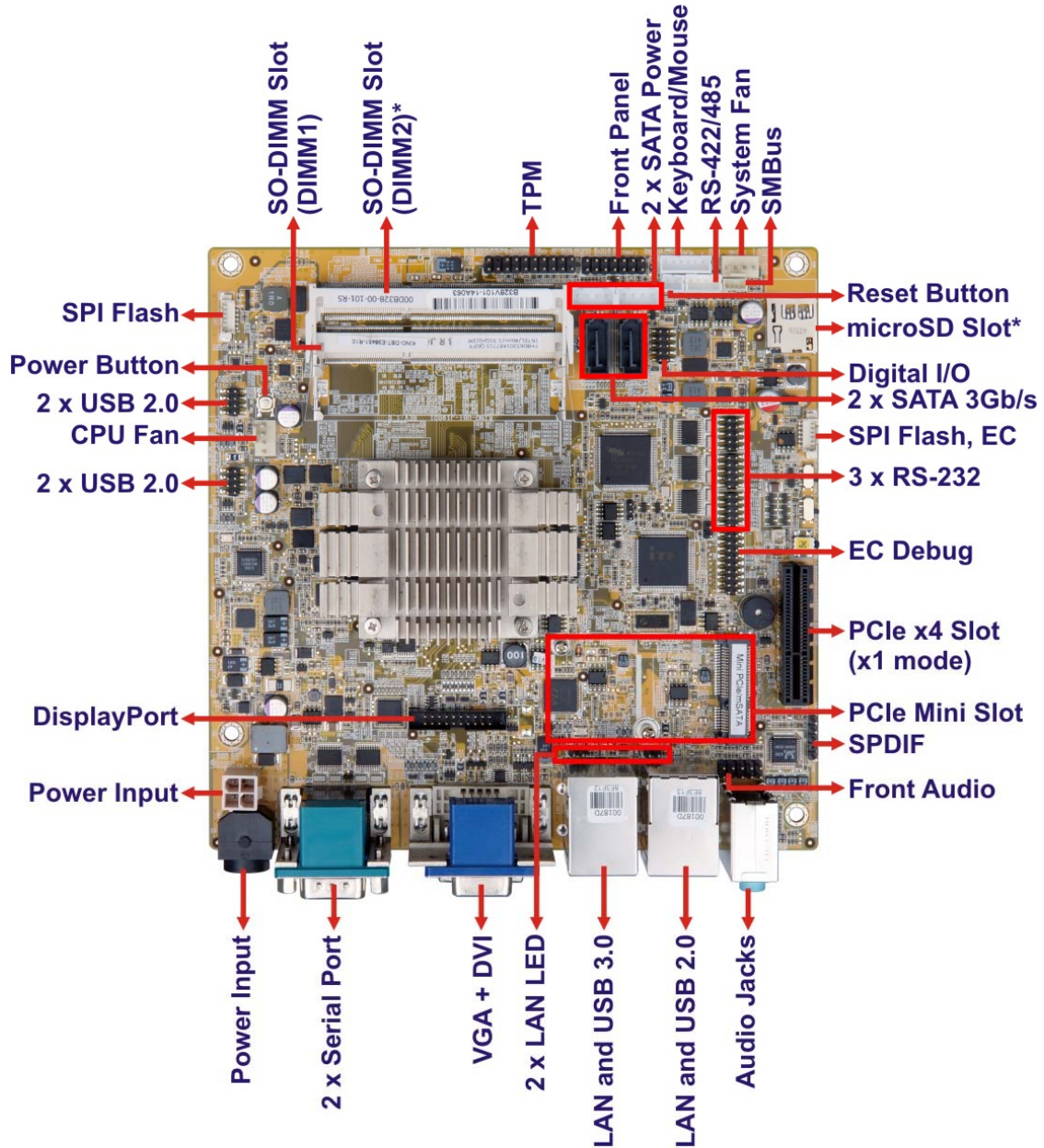

*microSD card slot is only available on E38xx1 models

*DIMM2 slot is only available on J1900, N2930, E3845, E3827 and E3826 models. For detailed information, please refer to **Section 3.2.12**.

Figure 1-2: Connectors

1.6 Dimensions

The main dimensions of the KINO-DBT series are shown in the diagram below.

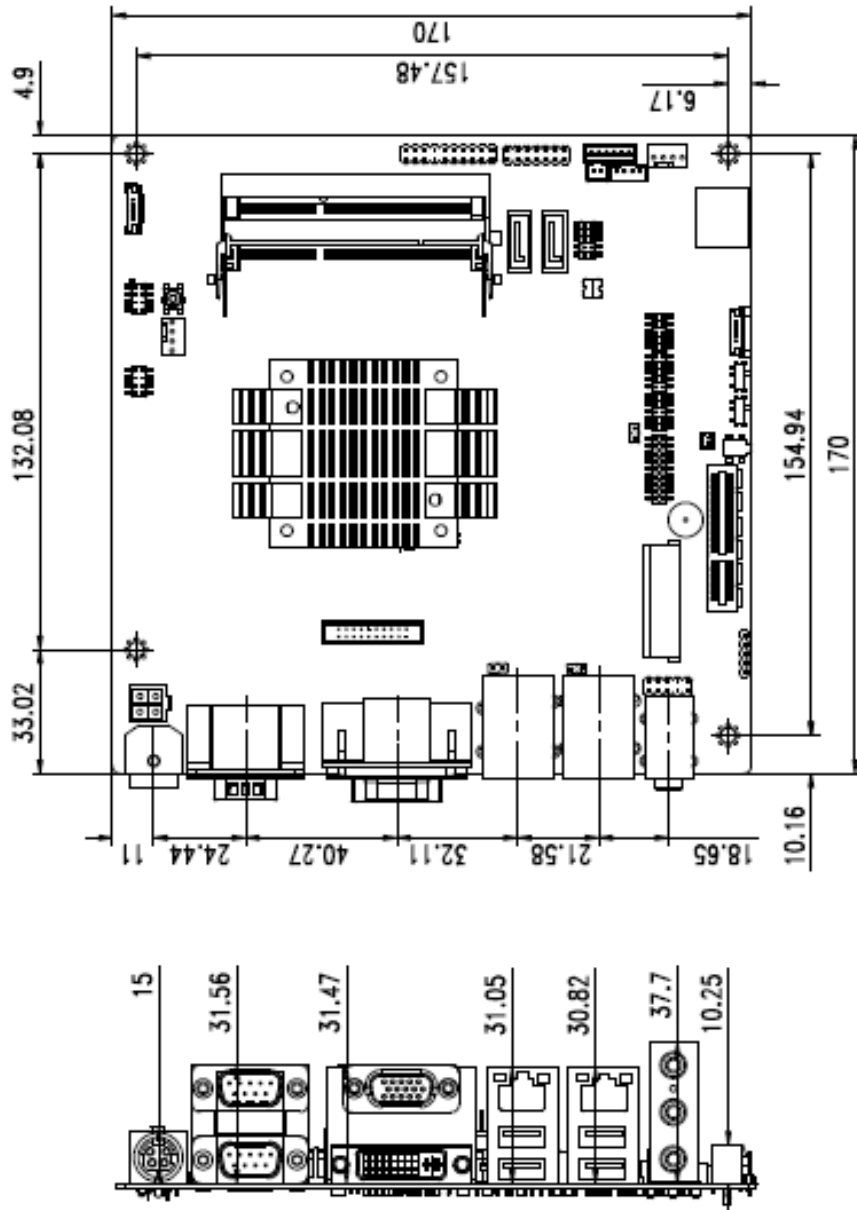

Figure 1-3: KINO-DBT Series Main Dimensions (mm)

KINO-DBT Mini-ITX SBC

1.7 Data Flow

Figure 1-4 shows the data flow between the system chipset, the CPU and other components installed on the motherboard.

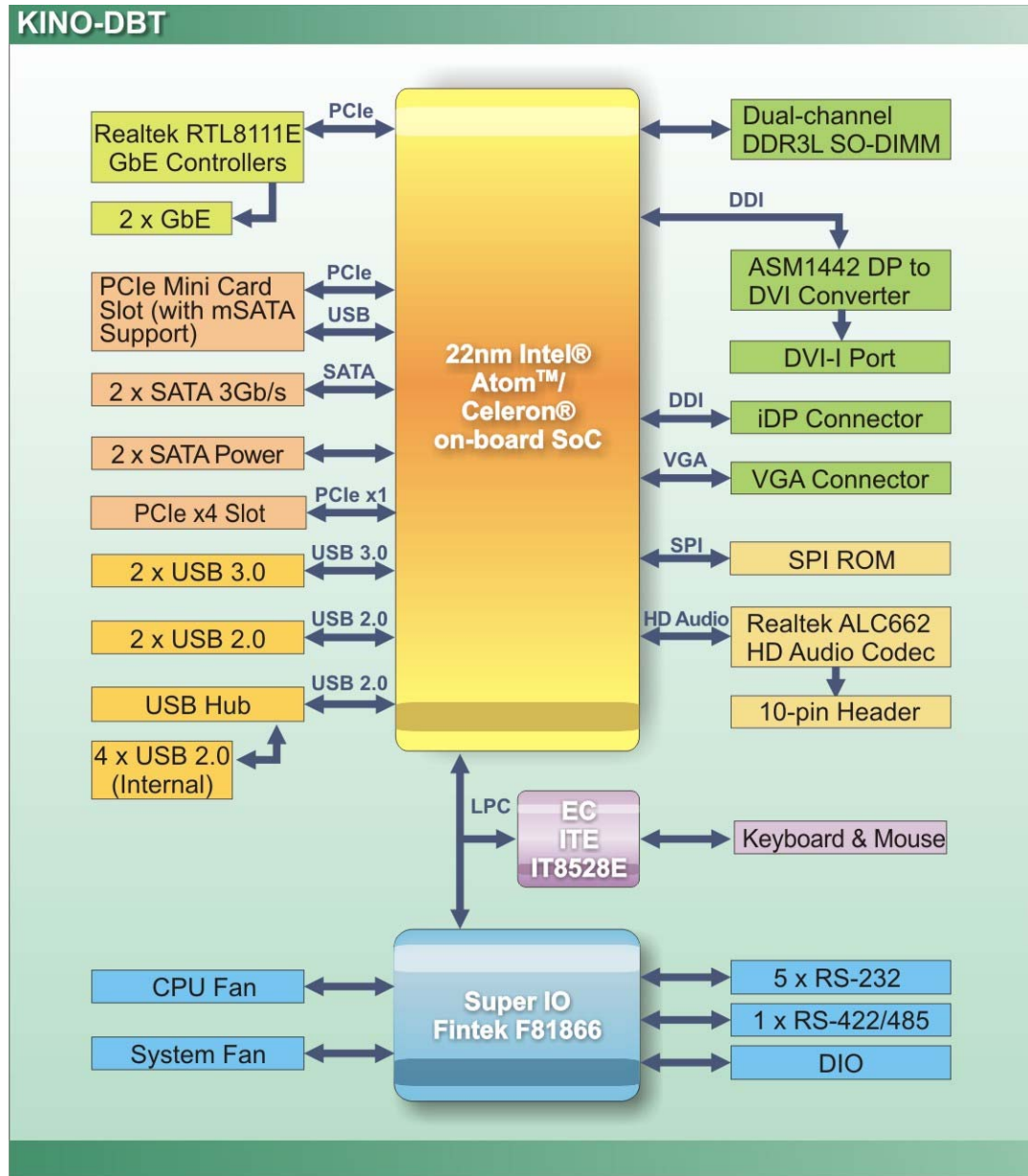

Figure 1-4: Data Flow Diagram

1.8 Technical Specifications

The KINO-DBT series technical specifications are listed below.

Specification/Model	KINO-DBT Series
Form Factor	Mini-ITX
On-board SoC	<ul style="list-style-type: none"> ▪ Standard <ul style="list-style-type: none"> ○ Intel® Celeron® processor J1900 (2GHz, quad-core, 2MB cache, TDP=10W) ○ Intel® Celeron® processor N2930 (1.83GHz, quad-core, 2MB cache, TDP=7.5W) ○ Intel® Celeron® processor N2807 (1.58GHz, dual-core, 2MB cache, TDP=4.5W) ▪ By request <ul style="list-style-type: none"> ○ Intel® Atom™ processor E3845 (1.91GHz, quad-core, 2MB cache, TDP=10W) ○ Intel® Atom™ processor E3827 (1.75GHz, dual-core, 1MB cache, TDP=8W) ○ Intel® Atom™ processor E3826 (1.46GHz, dual-core, 1MB cache, TDP=7W) ○ Intel® Atom™ processor E3825 (1.33GHz, dual-core, 1MB cache, TDP=6W) ○ Intel® Atom™ processor E3815 (1.46GHz, single-core, 512KB cache, TDP=5W)
Memory	<p>For J1900, N2930, E3845, E3827 and E3826 SKUs:</p> <p>Two 204-pin 1333/1066 MHz dual-channel unbuffered DDR3L SDRAM SO-DIMM slots support up to 8 GB of memory</p> <p>For N2807, E3825 and E3815 SKUs:</p> <p>One 204-pin 1333/1066 MHz unbuffered DDR3L SDRAM SO-DIMM slot supports up to 4 GB of memory</p> <p>* Use DIMM1 slot when installing one SO-DIMM. For the SO-DIMM slot location, refer to Figure 3-13.</p>

KINO-DBT Mini-ITX SBC

Specification/Model	KINO-DBT Series
Integrated Graphics	Intel® HD Graphics Gen7 with 4 execution units, supporting DirectX 11.1, OpenCL 1.2 and OpenGL 4.2
Audio	Realtek ALC662 HD Audio codec
BIOS	UEFI BIOS
Ethernet Controllers	Dual Realtek RTL8111E PCIe GbE controller
Digital I/O	8-bit digital I/O
Super I/O Controller	Fintek F81866D-I
Embedded Controller	ITE IT8528E/FX
Watchdog Timer	Software programmable supports 1 sec – 255 sec system reset
Expansion	
PCIe	One PCIe x4 (x1 mode) slot
PCIe Mini	One PCIe Mini card slot supports mSATA, co-lay SATA 2
microSD	One microSD card slot (E38xx models only)
I/O Interface Connectors	
Audio Connector	One internal audio connector (10-pin)
Display Ports	One VGA port (up to 2560 x 1200, 60Hz) One DVI-D port One internal DisplayPort (iDP) supporting HDMI, DVI, VGA, LVDS and DisplayPort
Ethernet	Two RJ-45 GbE ports
Keyboard/Mouse	One internal keyboard/mouse connector
Serial Ports	One RS-422/485 via internal wafer connector Three RS-232 via internal pin headers Two RS-232 via D-sub 9 connector

Specification/Model	KINO-DBT Series
USB ports	Two external USB 3.0 ports Two external USB 2.0 ports Four USB 2.0 ports by two 8-pin headers
Serial ATA	Two SATA 3Gb/s connectors with two SATA power connectors
LAN LED	Two 2-pin LAN active LED connectors
SMBus	Supported by one 4-pin wafer connector
Environmental and Power Specifications	
Power Supply	ATX/AT power supported 12 V DC input
Power Consumption	12V@1.64A (Intel® Atom™ J1900 with 4 GB 1333 MHz DDR3L memory)
Operating Temperature	-20°C – 70°C
Storage Temperature	-30°C – 85°C
Humidity	5% – 95% (non-condensing)
Physical Specifications	
Dimensions	170 mm x 170 mm
Weight GW/NW	900 g / 400 g

Table 1-2: KINO-DBT Series Specifications

Chapter

2

Packing List

2.1 Anti-static Precautions



WARNING!

Static electricity can destroy certain electronics. Make sure to follow the ESD precautions to prevent damage to the product, and injury to the user.

Make sure to adhere to the following guidelines:

- **Wear an anti-static wristband:** Wearing an anti-static wristband can prevent electrostatic discharge.
- **Self-grounding:** Touch a grounded conductor every few minutes to discharge any excess static buildup.
- **Use an anti-static pad:** When configuring any circuit board, place it on an anti-static mat.
- **Only handle the edges of the PCB:** Don't touch the surface of the motherboard. Hold the motherboard by the edges when handling.

2.2 Unpacking Precautions

When the KINO-DBT series is unpacked, please do the following:

- Follow the antistatic guidelines above.
- Make sure the packing box is facing upwards when opening.
- Make sure all the packing list items are present.

KINO-DBT Mini-ITX SBC

2.3 Packing List



NOTE:

If any of the components listed in the checklist below are missing, do not proceed with the installation. Contact the IEI reseller or vendor the KINO-DBT series was purchased from or contact an IEI sales representative directly by sending an email to sales@ieiworld.com

The KINO-DBT series is shipped with the following components:











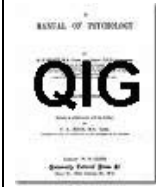

Quantity	Item and Part Number	Image
1	KINO-DBT single board computer	
1	SATA and power cable (P/N: 32801-000100-100-RS)	
1	I/O shielding (P/N: 45014-0056C0-00-RS)	
1	Utility CD	
1	Quick Installation Guide	

Table 2-1: Packing List

2.4 Optional Items

The following are optional components which may be separately purchased:

Item and Part Number	Image
KB/MS cable (P/N: 19800-000075-RS)	
RS-232 cable (P/N : 32205-002700-100-RS)	
RS-422/485 cable (P/N: 32205-003800-300-RS)	
DisplayPort to DisplayPort converter board for IEI iDP connector (P/N: DP-DP-R10)	
DisplayPort to DVI-D converter board for IEI iDP connector (P/N: DP-DVI-R10)	
DisplayPort to 24-bit dual-channel LVDS converter board for IEI iDP connector (P/N: DP-LVDS-R10)	
DisplayPort to VGA converter board for IEI iDP connector (P/N: DP-VGA-R10)	
DisplayPort to HDMI converter board for IEI iDP connector (P/N: DP-HDMI-R10)	

KINO-DBT Mini-ITX SBC

Item and Part Number	Image
Infineon TPM module, v3.17 firmware (P/N : TPM-IN01-R11)	 A photograph of an Infineon TPM module. It is a small green printed circuit board (PCB) with a central black integrated circuit (chip). The board has several gold-plated pins along its bottom edge, which are used for connection to a host system. The board is shown against a white background.

Chapter

3

Connectors

KINO-DBT Mini-ITX SBC

3.1 Peripheral Interface Connectors

This chapter details all the jumpers and connectors.

3.1.1 KINO-DBT Layout

The figures below show all the connectors and jumpers.

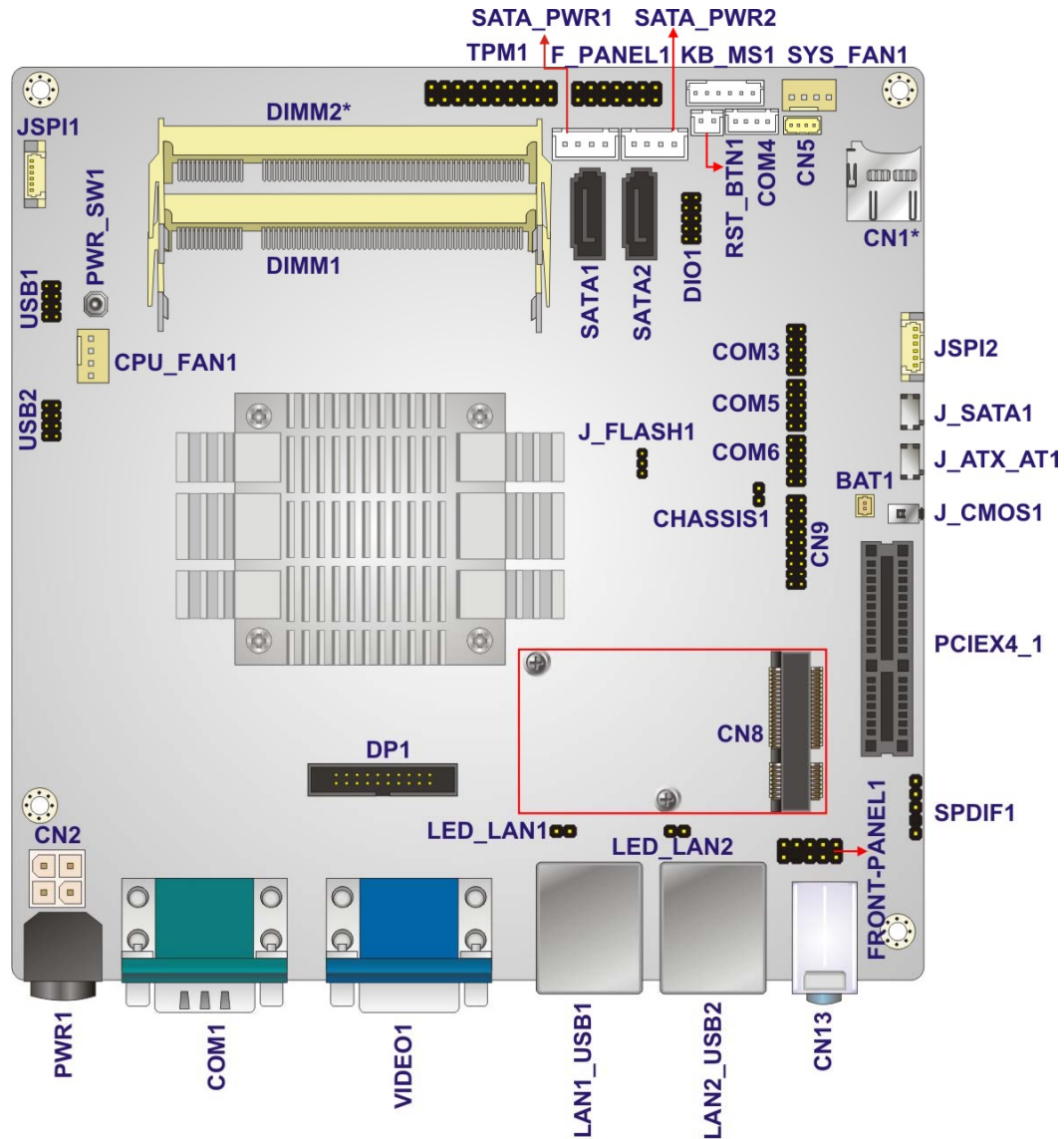

*microSD card slot (CN1) is only available on E38xx1 model

*DIMM2 slot is only available on J1900, N2930, E3845, E3827 and E3826 models. For detailed information, please refer to **Section 3.2.12**.

Figure 3-1: Connectors and Jumpers

3.1.2 Peripheral Interface Connectors

The table below lists all the connectors on the board.

Connector	Type	Label
Audio connector	10-pin header	FRONT-PANEL1
Battery connector	2-pin wafer	BAT1
Chassis intrusion connector	2-pin header	CHASSIS1
Digital I/O connector	10-pin header	DIO1
DisplayPort connector	20-pin box header	DP1
EC debug connector	18-pin header	CN9
Fan connector (CPU)	4-pin wafer	CPU_FAN1
Fan connector (system)	4-pin wafer	SYS_FAN1
Front panel connector	14-pin header	F_PANEL1
Keyboard and mouse connector	6-pin wafer	KB_MS1
LAN1 LED connector	2-pin header	LED_LAN1
LAN2 LED connector	2-pin header	LED_LAN2
Memory card slot(s)	SO-DIMM slot	DIMM1, DIMM2*
microSD card slot (E38xx models only)	microSD slot	CN1
PCIe x4 slot (x1 mode)	PCIe x4 slot	PCIEX4_1
PCIe Mini slot	52-pin PCIe Mini slot	CN8
Power button	Push button	PWR_SW1
Power input connector	4-pin connector	CN2
Reset button connector	2-pin wafer	RST_BTN1

KINO-DBT Mini-ITX SBC

Connector	Type	Label
SATA 3Gb/s drive connectors	7-pin SATA connector	SATA1, SATA2
SATA power connectors (5 V)	2-pin wafer	SATA_PWR1, SATA_PWR2
Serial ports, RS-232	10-pin header	COM3, COM5, COM6
Serial port, RS-422/485	4-pin wafer	COM4
SMBus connector	4-pin wafer	CN5
SPDIF connector	5-pin header	SPDIF1
SPI flash connector	6-pin wafer	JSPI1
SPI flash connector (EC)	6-pin wafer	JSPI2
TPM connector	20-pin header	TPM1
USB 2.0 connectors	8-pin header	USB1, USB2
*DIMM2 slot is only available on J1900, N2930, E3845, E3827 and E3826 models		

Table 3-1: Peripheral Interface Connectors

3.1.3 External Interface Panel Connectors

The table below lists the connectors on the external I/O panel.

Connector	Type	Label
Audio connectors	Audio jack	CN13
DVI connector	DVI-D	VIDEO1
Ethernet and USB 2.0 combo connector	RJ-45 and USB 2.0	LAN2_USB2
Ethernet and USB 3.0 combo connector	RJ-45 and USB 3.0	LAN1_USB1
Power connector	4-pin DIN	PWR1
Serial port connectors	D-sub 9, male	COM1
VGA connector	D-sub 15, female	VIDEO1

Table 3-2: Rear Panel Connectors

3.2 Internal Peripheral Connectors

The section describes all of the connectors on the KINO-DBT series.

3.2.1 Audio Connector

- CN Label:** FRONT-PANEL1
- CN Type:** 10-pin header, p=2.54 mm
- CN Location:** See **Figure 3-2**
- CN Pinouts:** See **Table 3-3**

This connector connects to speakers, a microphone and an audio input.

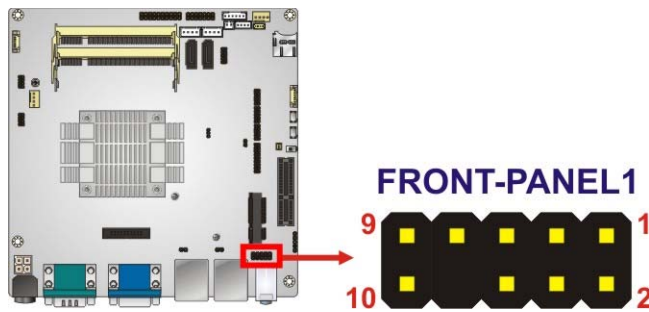

Figure 3-2: Audio Connector Location

Pin	Description	Pin	Description
1	MIC2-L	2	GND
3	MIC2-R	4	Presence#
5	LINE2-R	6	MIC2-JD
7	FRONT-IO	8	NC
9	LINE2-L	10	LINE2-JD

Table 3-3: Audio Connector Pinouts

KINO-DBT Mini-ITX SBC

3.2.2 Battery Connector



CAUTION:

Risk of explosion if battery is replaced by an incorrect type. Only certified engineers should replace the on-board battery.

Dispose of used batteries according to instructions and local regulations.

- CN Label:** **BAT1**
- CN Type:** 2-pin wafer, p=1.25 mm
- CN Location:** See **Figure 3-3**
- CN Pinouts:** See **Table 3-4**

A system battery is placed in the battery holder. The battery provides power to the system clock to retain the time when power is turned off.

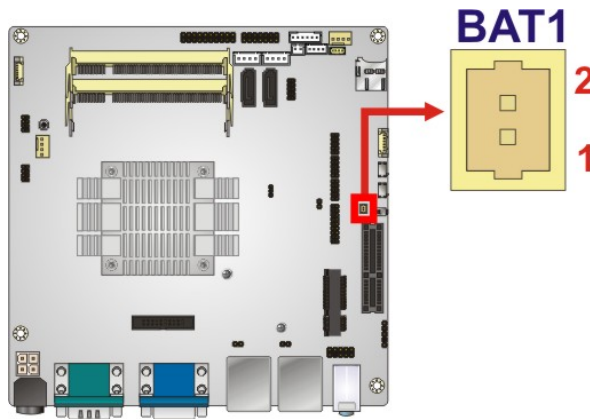

Figure 3-3: Battery Connector Location

Pin	Description
1	VBATT
2	GND

Table 3-4: Battery Connector Pinouts

3.2.3 Chassis Intrusion Connector

- CN Label:** CHASSIS1
- CN Type:** 2-pin header, p=2.54 mm
- CN Location:** See **Figure 3-4**
- CN Pinouts:** See **Table 3-5**

The chassis intrusion connector is for a chassis intrusion detection sensor or switch that detects if a chassis component is removed or replaced.

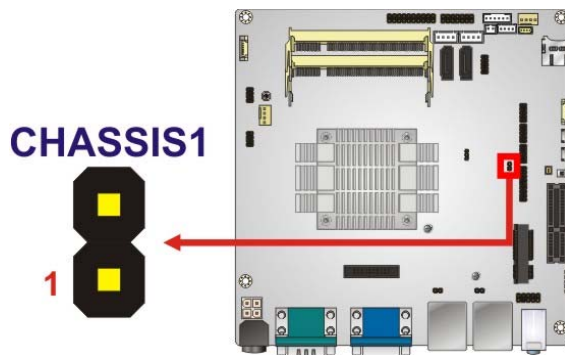

Figure 3-4: Chassis Intrusion Connector Location

Pin	Description
1	+V3.3A_EC
2	CHASSIS_EC

Table 3-5: Chassis Intrusion Connector Pinouts

3.2.4 Digital I/O Connector

- CN Label:** DIO1
- CN Type:** 10-pin header, p=2.00 mm
- CN Location:** See **Figure 3-5**
- CN Pinouts:** See **Table 3-6**

The digital I/O connector provides programmable input and output for external devices. The digital I/O provides 4-bit output and 4-bit input.

KINO-DBT Mini-ITX SBC

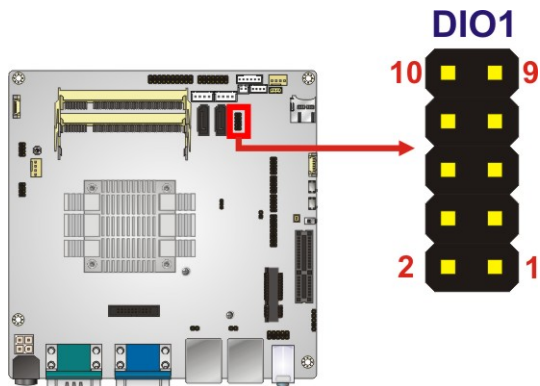

Figure 3-5: Digital I/O Connector Location

PIN NO.	DESCRIPTION	PIN NO.	DESCRIPTION
1	GND	2	+5V
3	DOUT3	4	DOUT2
5	DOUT1	6	DOUT0
7	DIN3	8	DIN2
9	DIN1	10	DINO

Table 3-6: Digital I/O Connector Pinouts

3.2.5 DisplayPort Connector

- CN Label:** DP1
- CN Type:** 20-pin header, p=2.00 mm
- CN Location:** See **Figure 3-6**
- CN Pinouts:** See **Table 3-7**

The internal DisplayPort connector supports HDMI, LVDS, VGA, DVI, DP connections with up to 3840 x 2160 resolutions.

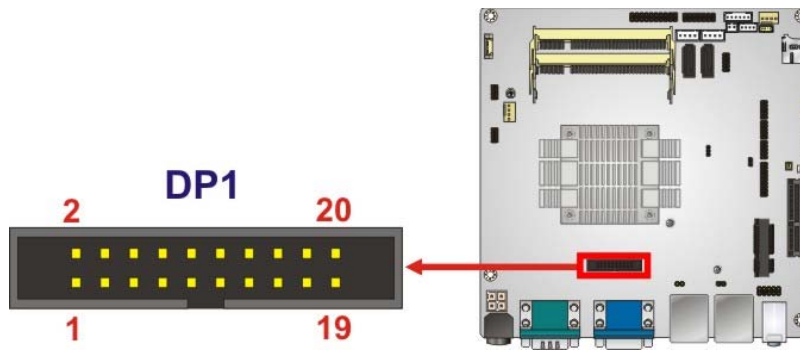

Figure 3-6: DisplayPort Connector Location

Pin	Description	Pin	Description
1	HPD	11	LANE3N
2	AUXP	12	GND
3	GND	13	GND
4	AUXN	14	LANE0P
5	AUX_CTRL_DET_D	15	LANE1P
6	GND	16	LANE0N
7	GND	17	LANE1N
8	LANE2P	18	+3.3V
9	LANE3P	19	+5V
10	LANE2N		

Table 3-7: DisplayPort Connector Pinouts

3.2.6 EC Debug Connector

- CN Label:** CN9
- CN Type:** 18-pin header, p=2.00 mm
- CN Location:** See **Figure 3-7**
- CN Pinouts:** See **Table 3-8**

The EC debug connector is used for EC debug.

KINO-DBT Mini-ITX SBC

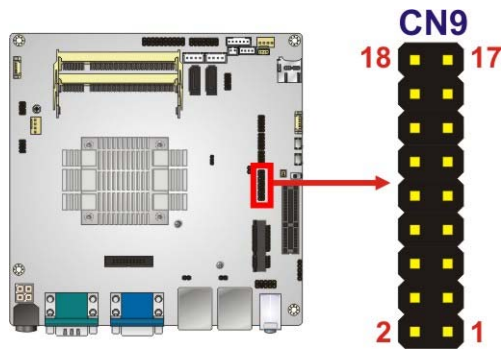

Figure 3-7: EC Debug Connector Location

Pin	Description	Pin	Description
1	EC_EPP_STB#	2	EC_EPP_AFD#
3	EC_EPP_PD0	4	NC
5	EC_EPP_PD1	6	EC_EPP_INIT#
7	EC_EPP_PD2	8	EC_EPP_SLIN#
9	EC_EPP_PD3	10	GND
11	EC_EPP_PD4	12	NC
13	EC_EPP_PD5	14	EC_EPP_BUSY
15	EC_EPP_PD6	16	EC_EPP_KSI5
17	EC_EPP_PD7	18	EC_EPP_KSI4

Table 3-8: EC Debug Connector Pinouts

3.2.7 Fan Connector (CPU)

- CN Label:** CPU_FAN1
- CN Type:** 4-pin wafer, p=2.54 mm
- CN Location:** See **Figure 3-8**
- CN Pinouts:** See **Table 3-9**

The fan connector attaches to a CPU cooling fan.

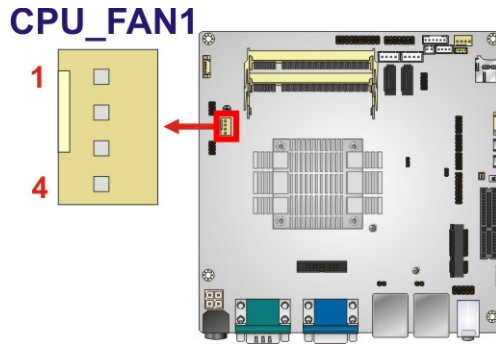

Figure 3-8: CPU Fan Connector Location

PIN NO.	DESCRIPTION
1	GND
2	+12 V
3	FAN_IO
4	PWM

Table 3-9: CPU Fan Connector Pinouts

3.2.8 Fan Connector (System)

- CN Label:** **SYS_FAN1**
- CN Type:** 4-pin wafer, p=2.54 mm
- CN Location:** See **Figure 3-9**
- CN Pinouts:** See **Table 3-10**

Each fan connector attaches to a system cooling fan.

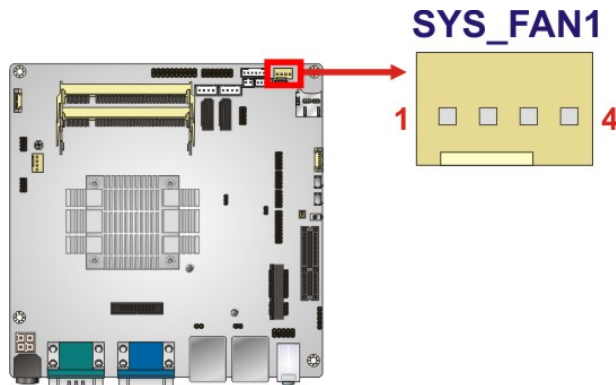

Figure 3-9: System Fan Connector Location

KINO-DBT Mini-ITX SBC

PIN NO.	DESCRIPTION
1	GND
2	+12 V
3	FAN_IO
4	PWM

Table 3-10: System Fan Connector Pinouts

3.2.9 Front Panel Connector

- CN Label:** F_PANEL1
- CN Type:** 14-pin header, p=2.54 mm
- CN Location:** See Figure 3-10
- CN Pinouts:** See Table 3-11

The front panel connector connects to the indicator LEDs and buttons on the computer's front panel.

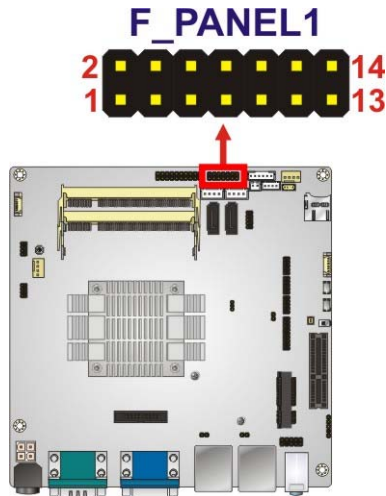

Figure 3-10: Front Panel Connector Location

FUNCTION	PIN	DESCRIPTION	FUNCTION	PIN	DESCRIPTION
Power LED	1	PWR_LED+	Speaker	2	Speaker+
	3	NC		IPMI LED	4
	5	PWR_LED-	6		IPMI_LED-

FUNCTION	PIN	DESCRIPTION	FUNCTION	PIN	DESCRIPTION
Power Button	7	PWR_BTN+	Speaker	8	Speaker-
	9	PWR_BTN-		10	NC
HDD LED	11	HDD_LED+	Reset Button	12	Reset+
	13	HDD_LED-		14	Reset-

Table 3-11: Front Panel Connector Pinouts

3.2.10 Keyboard and Mouse Connector

- CN Label:** KB_MS1
- CN Type:** 6-pin wafer, p=2.00 mm
- CN Location:** See Figure 3-11
- CN Pinouts:** See Table 3-12

The keyboard and mouse connector connects to a PS/2 Y-cable that can be connected to a PS/2 keyboard and mouse.

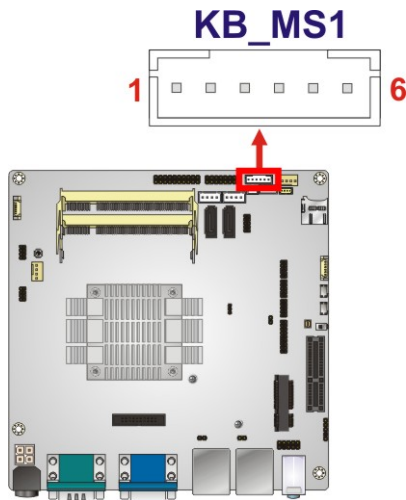

Figure 3-11: Keyboard and Mouse Connector Location

Pin	Description
1	VCC
2	Mouse Data
3	Mouse Clock

KINO-DBT Mini-ITX SBC

Pin	Description
4	Keyboard Data
5	Keyboard Clock
6	GND

Table 3-12: Keyboard and Mouse Connector Pinouts

3.2.11 LAN LED Connectors

CN Label: LED_LAN1, LED_LAN2

CN Type: 2-pin header, p=2.54 mm

CN Location: See **Figure 3-12**

CN Pinouts: See **Table 3-13** and **Table 3-14**

The LAN LED connectors are used to connect to the LAN LED indicators on the chassis to indicate users the link activities of the two LAN ports.

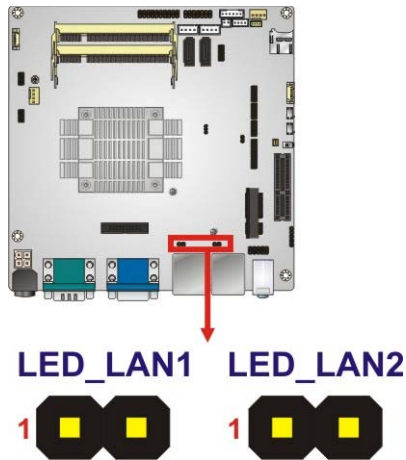

Figure 3-12: LAN LED Connector Locations

Pin	Description
1	+3.3 V
2	LAN1_LINK_ACT-

Table 3-13: LAN1 LED Connector Pinouts

Pin	Description
1	+3.3 v
2	LAN2_LINK_ACT-

Table 3-14: LAN2 LED Connector Pinouts

3.2.12 Memory Card Slot(s)

CN Label: DIMM1, DIMM2

CN Type: DDR3 SO-DIMM slot

CN Location: See **Figure 3-13**

The SO-DIMM slot is for installing DDR3 Low Voltage SO-DIMM memory modules.

- **For J1900, N2930, E3845, E3827 and E3826 SKUs:**
Two 204-pin 1333/1066 MHz dual-channel unbuffered DDR3L SDRAM SO-DIMM slots (DIMM1 and DIMM2) support up to 8 GB of memory
- **For N2807, E3825 and E3815 SKUs:**
One 204-pin 1333/1066 MHz unbuffered DDR3L SDRAM SO-DIMM slot (DIMM1) supports up to 4 GB of memory



NOTE:

Use **DIMM1** slot when installing one SO-DIMM.

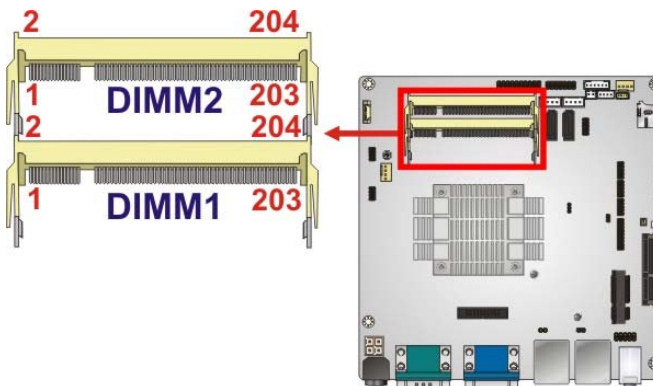

Figure 3-13: Memory Card Slot Locations

KINO-DBT Mini-ITX SBC

3.2.13 PCIe x4 Slot

CN Label:	PCIEX4_1
CN Type:	PCIe x4 slot
CN Location:	See Figure 3-14

The PCIe x4 interface provides x1 speed for PCIe expansion cards.

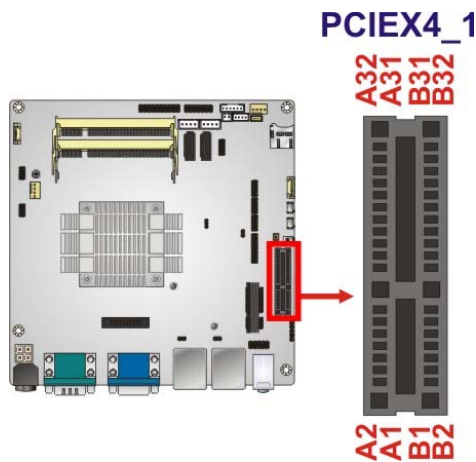

Figure 3-14: PCIe x4 Slot Location

3.2.14 PCIe Mini Card Slot

CN Label:	CN8
CN Type:	PCIe Mini card slot
CN Location:	See Figure 3-15
CN Pinouts:	See Table 3-15

The PCIe Mini card slot is for installing PCIe Mini expansion cards, such as mSATA modules or Wi-Fi modules.

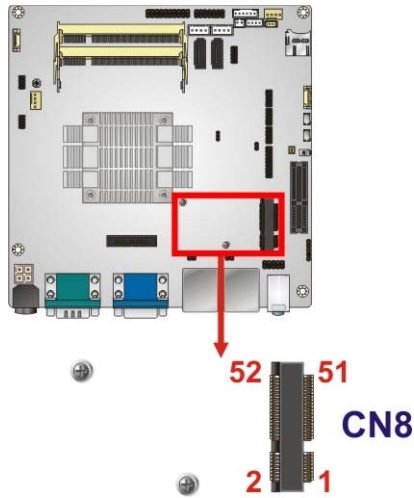

Figure 3-15: PCIe Mini Card Slot Location

Pin	Description	Pin	Description
1	PCIE_WAKE#	2	+3.3 V
3	N/C	4	GND
5	N/C	6	+1.5 V
7	N/C	8	N/C
9	GND	10	N/C
11	MSATA_CLK-	12	N/C
13	MSATA_CLK+	14	N/C
15	GND	16	N/C
17	PLTRST_N	18	GND
19	N/C	20	+3.3 V
21	GND	22	PLTRST_N
23	SATA_RX+	24	+3.3 V
25	SATA_RX-	26	GND
27	GND	28	+1.5 V
29	GND	30	SMB_CLK
31	SATA_TX-	32	SMBD_ATA
33	SATA_TX+	34	GND
35	GND	36	USB_DATA-
37	GND	38	USB_DATA+

KINO-DBT Mini-ITX SBC

Pin	Description	Pin	Description
39	+3.3 V	40	GND
41	+3.3 V	42	N/C
43	+3.3 V	44	N/C
45	CLINK_CLK	46	N/C
47	CLINK_DATA	48	+1.5 V
49	CLINK_RST#	50	GND
51	MSATA_DET	52	+3.3 V

Table 3-15: PCIe Mini Card Slot Pinouts

3.2.15 Power Button

- CN Label:** PWR_SW1
- CN Type:** Push button
- CN Location:** See **Figure 3-16**

The on-board power button controls system power.

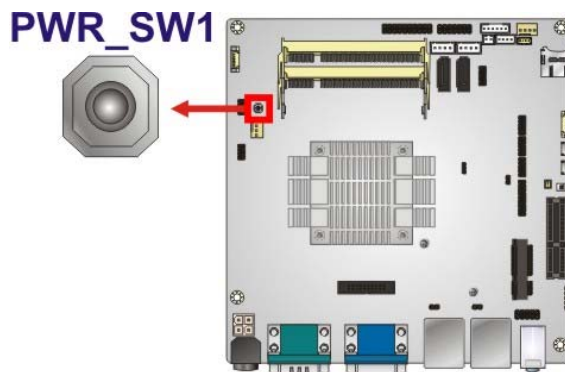

Figure 3-16: Power Button Location

3.2.16 Power Connector

- CN Label:** CN2
- CN Type:** 4-pin connector, p=4.2 mm
- CN Location:** See **Figure 3-17**

CN Pinouts: See **Table 3-16**

The power input connector provides power to the system.

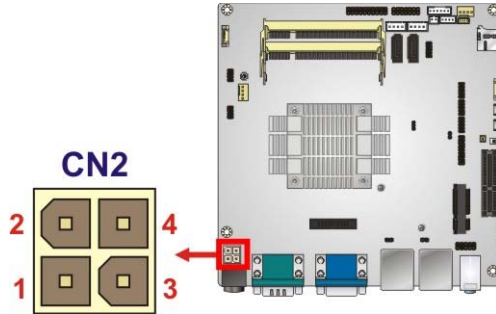

Figure 3-17: Power Connector Location

Pin	Description	Pin	Description
1	GND	3	+12 V
2	GND	4	+12 V

Table 3-16: Power Connector Pinouts

3.2.17 Reset Button Connector

CN Label: RST_BTN1

CN Type: 2-pin wafer, p=2.00 mm

CN Location: See **Figure 3-18**

CN Pinouts: See **Table 3-17**

The reset button connector is connected to a reset switch on the system chassis.

KINO-DBT Mini-ITX SBC

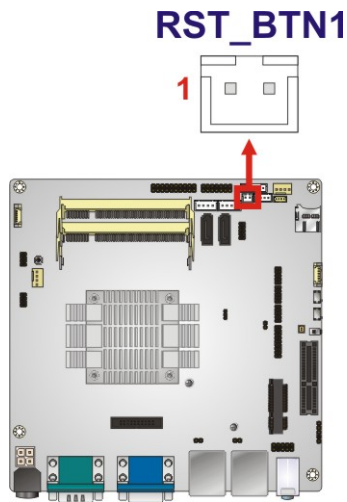

Figure 3-18: Reset Button Connector Location

Pin	Description
1	Reset+
2	Reset-

Table 3-17: Reset Button Connector Pinouts

3.2.18 SATA 3Gb/s Drive Connectors

- CN Label:** SATA1, SATA2
- CN Type:** 7-pin SATA drive connectors
- CN Location:** See **Figure 3-19**
- CN Pinouts:** See **Table 3-18**

The SATA drive connectors can be connected to SATA drives.

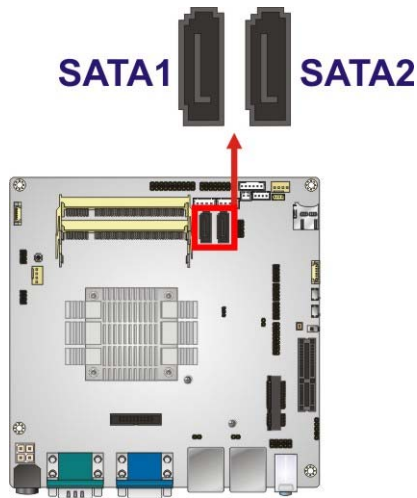

Figure 3-19: SATA 3Gb/s Drive Connector Locations

Pin	Description
1	GND
2	SATA_TX+
3	SATA_TX-
4	GND
5	SATA_RX-
6	SATA_RX+
7	GND

Table 3-18: SATA 3Gb/s Drive Connector Pinouts

3.2.19 SATA Power Connectors

CN Label: SATA_PWR1, SATA_PWR2

CN Type: 4-pin wafer, p=2.54 mm

CN Location: See **Figure 3-20**

CN Pinouts: See **Table 3-19**

Use the SATA Power Connector to connect to SATA device power connections.

KINO-DBT Mini-ITX SBC

SATA_PWR1 SATA_PWR2

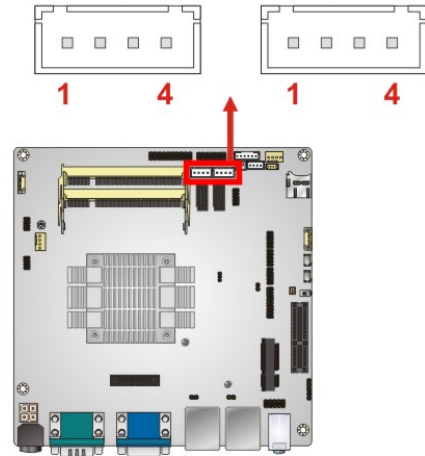

Figure 3-20: SATA Power Connector Locations

Pin	Description
1	+12 V
2	GND
3	GND
4	+5 V

Table 3-19: SATA Power Connector Pinouts

3.2.20 Serial Port Connectors, RS-232

CN Label: COM3, COM5, COM6

CN Type: 10-pin header, p=2.00 mm

CN Location: See **Figure 3-21**

CN Pinouts: See **Table 3-20**

The connector provides RS-232 port connection.

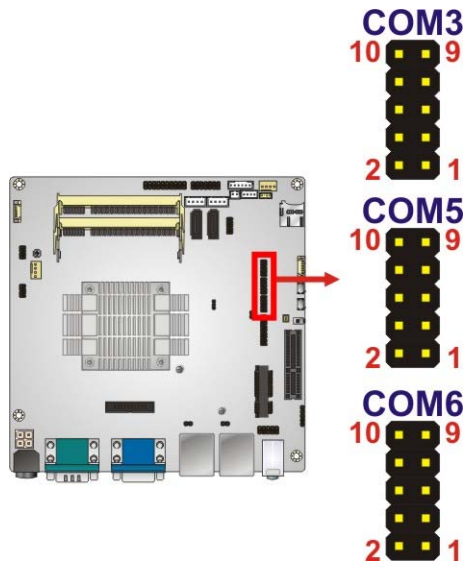

Figure 3-21: RS-232 Serial Port Connector Locations

PIN NO.	DESCRIPTION	PIN NO.	DESCRIPTION
1	DCD	2	DSR
3	RXD	4	RTS
5	TXD	6	CTS
7	DTR	8	RI
9	GND	10	GND

Table 3-20: RS-232 Serial Port Connector Pinouts

3.2.21 Serial Port Connector, RS-422/485

- CN Label:** COM4
- CN Type:** 4-pin wafer, p=2.00 mm
- CN Location:** See Figure 3-22
- CN Pinouts:** See Table 3-21

Used for RS-422/485 communications.

KINO-DBT Mini-ITX SBC

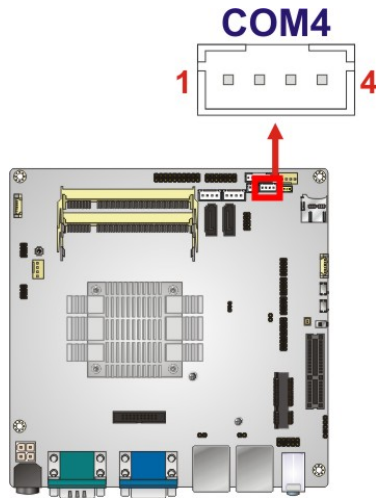

Figure 3-22: RS-422/485 Connector Location

PIN NO.	DESCRIPTION
1	RXD422-
2	RXD422+
3	TXD422+/TXD485+
4	TXD422-/TXD485-

Table 3-21: RS-422/485 Connector Pinouts

Use the optional RS-422/485 cable to connect to a serial device. The pinouts of the D-sub 9 connector are listed below.

RS-422 Pinouts	RS-485 Pinouts

Table 3-22: RS-422/485 Pinouts of D-sub 9 Connector

3.2.22 SMBus Connector

- CN Label:** CN5
- CN Type:** 4-pin wafer, p=1.25 mm
- CN Location:** See **Figure 3-23**
- CN Pinouts:** See **Table 3-23**

The SMBus (System Management Bus) connector provides low-speed system management communications.

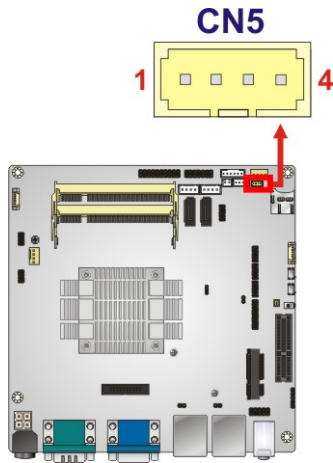

Figure 3-23: SMBus Connector Location

PIN	DESCRIPTION
1	GND
2	SMB_DATA
3	SMB_CLK
4	+5 V

Table 3-23: SMBus Connector Pinouts

KINO-DBT Mini-ITX SBC

3.2.23 SPDIF Connector

- CN Label:** SPDIF1
- CN Type:** 5-pin header, p=2.54 mm
- CN Location:** See **Figure 3-24**
- CN Pinouts:** See **Table 3-24**

Use the SPDIF connector to connect digital audio devices to the system.

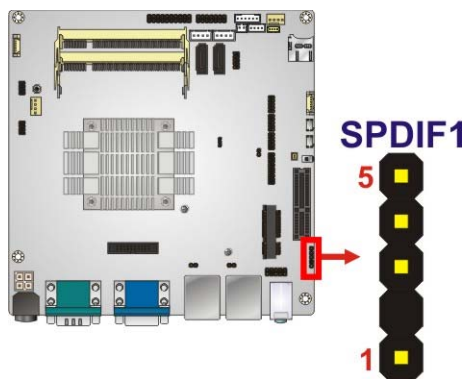

Figure 3-24: SPDIF Connector Location

Pin	Description
1	+5 V
2	N/A
3	SPDIF OUT
4	GND
5	SPDIF IN

Table 3-24: SPDIF Connector Pinouts

3.2.24 SPI Flash Connector

- CN Label:** JSPI1
- CN Type:** 6-pin wafer, p=1.25 mm
- CN Location:** See **Figure 3-25**

CN Pinouts: See **Table 3-25**

The SPI flash connector is used to flash the SPI ROM.

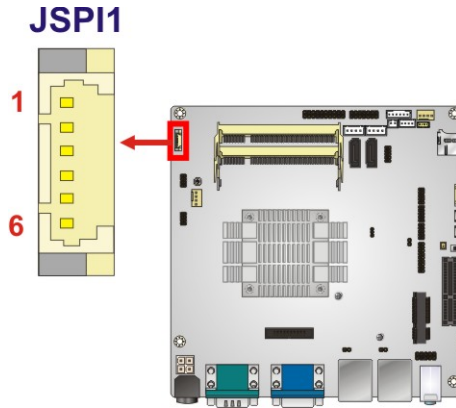

Figure 3-25: SPI Flash Connector Location

PIN NO.	DESCRIPTION	PIN NO.	DESCRIPTION
1	+1.8 V	4	SPI_CLK
2	SPI_CS#	5	SPI_SI
3	SPI_SO	6	GND

Table 3-25: SPI Flash Connector Pinouts

3.2.25 SPI Flash Connector, EC

CN Label: JSPI2

CN Type: 6-pin wafer, p=1.25 mm

CN Location: See **Figure 3-26**

CN Pinouts: See **Table 3-26**

The SPI flash connector is used to flash the EC ROM.

KINO-DBT Mini-ITX SBC

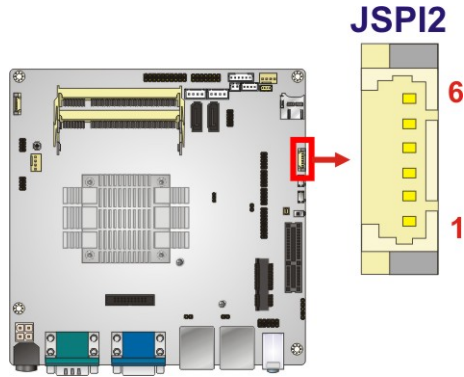

Figure 3-26: SPI EC Flash Connector Location

PIN NO.	DESCRIPTION	PIN NO.	DESCRIPTION
1	+1.8 V	4	SPI_CLK
2	SPI_CS#	5	SPI_SI
3	SPI_SO	6	GND

Table 3-26: SPI EC Flash Connector Pinouts

3.2.26 TPM Connector

- CN Label:** TPM1
- CN Type:** 20-pin header, p=2.54 mm
- CN Location:** See **Figure 3-27**
- CN Pinouts:** See **Table 3-27**

The TPM connector connects to a TPM module.

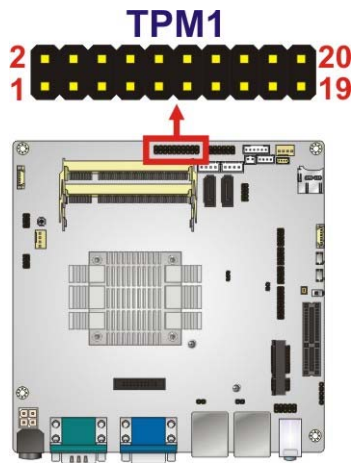

Figure 3-27: TPM Connector Location

Pin	Description	Pin	Description
1	LPC_CLK	2	GND
3	LPC_FRAME#	4	N/A
5	BUF_PLT_RST#	6	+5V
7	LPC_AD3	8	LPC_AD2
9	+3.3V	10	LPC_AD1
11	LPC_AD0	12	GND
13	SMB_CLK	14	SMB_DATA
15	+3.3 V	16	INT_SERIRQ
17	GND	18	PM_GLKRUN#
19	+3.3 V	20	TPM_DRQ#

Table 3-27: TPM Connector Pinouts

3.2.27 USB 2.0 Connectors

- CN Label:** USB1, USB2
- CN Type:** 8-pin header, p=2.00 mm
- CN Location:** See **Figure 3-28**
- CN Pinouts:** See **Table 3-28** and **Table 3-29**

The USB 2.0 connector connects to USB 2.0 devices. Each pin header provides two USB 2.0 ports.

KINO-DBT Mini-ITX SBC

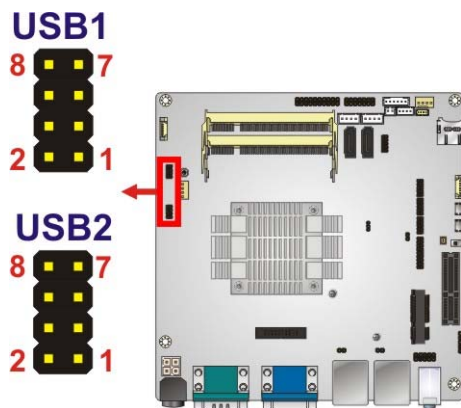

Figure 3-28: USB 2.0 Connector Locations

PIN NO.	DESCRIPTION	PIN NO.	DESCRIPTION
1	+VCC_USB45	2	GND
3	DATA4-	4	DATA5+
5	DATA4+	6	DATA5-
7	GND	8	+VCC_USB45

Table 3-28: USB1 Pinouts

PIN NO.	DESCRIPTION	PIN NO.	DESCRIPTION
1	+VCC_USB67	2	GND
3	DATA6-	4	DATA7+
5	DATA6+	6	DATA7-
7	GND	8	+VCC_USB67

Table 3-29: USB2 Pinouts

3.3 External Peripheral Interface Connector Panel

The figure below shows the external peripheral interface connector (EPIC) panel. The EPIC panel consists of the following:

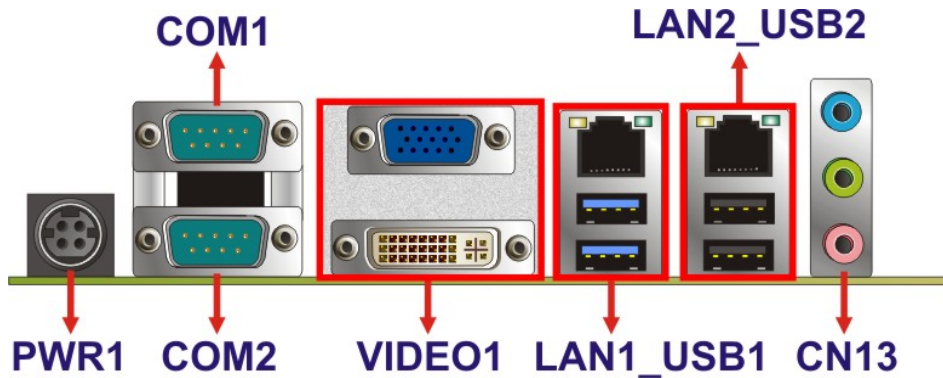

Figure 3-29: External Peripheral Interface Connector

3.3.1 Audio Connector

CN Label:	CN13
CN Type:	Audio jacks
CN Location:	See Figure 3-29

The audio jacks connect to external audio devices.

- **Line In port (Light Blue):** Connects a CD-ROM, DVD player, or other audio devices.
- **Line Out port (Lime):** Connects to a headphone or a speaker. With multi-channel configurations, this port can also connect to front speakers.
- **Microphone (Pink):** Connects a microphone.

KINO-DBT Mini-ITX SBC

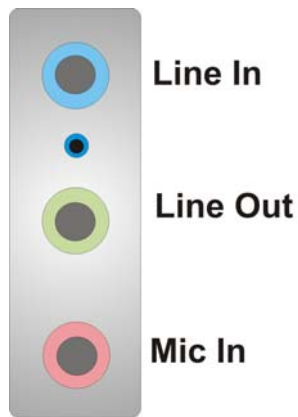

Figure 3-30: Audio Connector

3.3.2 DVI Connector

- CN Label:** DVI1
- CN Type:** DVI-I connector
- CN Location:** See **Figure 3-29**
- CN Pinouts:** See **Figure 3-31** and **Table 3-30**

The 24-pin Digital Visual Interface (DVI) connector connects to high-speed, high-resolution digital displays. The DVI-I connector supports both digital and analog signals.

Pin	Description	Pin	Description	Pin	Description
1	TMDS Data2-	9	TMDS Data1-	17	TMDS Data0-
2	TMDS Data2+	10	TMDS Data1+	18	TMDS Data0+
3	GND	11	GND	19	GND
4	N/C	12	NC	20	NC
5	N/C	13	NC	21	NC
6	DDC Clock [SCL]	14	PVDD1	22	GND
7	DDC Data [SDA]	15	GND	23	TMDS Clock +
8	Analog vertical sync	16	GND	24	TMDS Clock -
C1	Analog Red	--	--	--	--
C2	Analog Green	--	--	--	--
C3	Analog Blue	--	--	--	--

C4	Analog Horizontal Sync	--	--	--	--
C5	Analog GND	--	--	--	--

Table 3-30: DVI Connector Pinouts

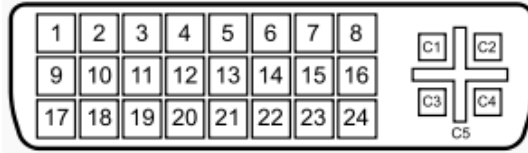

Figure 3-31: DVI-I Connector

3.3.3 Ethernet and USB 2.0 Combo Connector

- CN Label:** LAN2_USB2
- CN Type:** RJ-45 and USB 2.0 connector
- CN Location:** See **Figure 3-29**
- CN Pinouts:** See **Table 3-31** and **Table 3-33**

A 10/100/1000 Mb/s connection can be made to a Local Area Network.

Pin	Description	Pin	Description
1	LAN2_MDI0P	5	LAN2_MDI2P
2	LAN2_MDI0N	6	LAN2_MDI2N
3	LAN2_MDI1P	7	LAN2_MDI3P
4	LAN2_MDI1N	8	LAN2_MDI3N

Table 3-31: LAN2 Ethernet Connector Pinouts

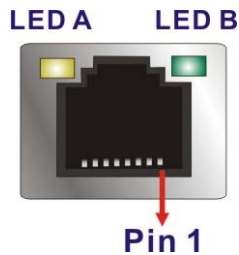

Figure 3-32: Ethernet Connector

KINO-DBT Mini-ITX SBC

LED	Description	LED	Description
A	on: linked blinking: data is being sent/received	B	off: 10 Mb/s green: 100 Mb/s orange: 1000 Mb/s

Table 3-32: Connector LEDs

The USB 2.0 connector can be connected to a USB 2.0 device.

Pin	Description	Pin	Description
1	VCC	5	VCC
2	USB_DATA-	6	USB_DATA-
3	USB_DATA+	7	USB_DATA+
4	GND	8	GND

Table 3-33: USB 2.0 Port Pinouts

3.3.4 Ethernet and USB 3.0 Combo Connector

CN Label: LAN1_USB1

CN Type: RJ-45 and USB 3.0 connector

CN Location: See **Figure 3-29**

CN Pinouts: See **Table 3-34** and **Table 3-36**

A 10/100/1000 Mb/s connection can be made to a Local Area Network.

Pin	Description	Pin	Description
1	LAN1_MDI0P	5	LAN1_MDI2P
2	LAN1_MDI0N	6	LAN1_MDI2N
3	LAN1_MDI1P	7	LAN1_MDI3P
4	LAN1_MDI1N	8	LAN1_MDI3N

Table 3-34: LAN1 Ethernet Connector Pinouts

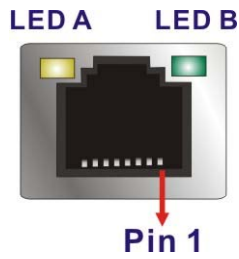

Figure 3-33: Ethernet Connector

LED	Description	LED	Description
A	on: linked blinking: data is being sent/received	B	off: 10 Mb/s green: 100 Mb/s orange: 1000 Mb/s

Table 3-35: Connector LEDs

The USB 3.0 connector can be connected to a USB device.

Pin	Description	Pin	Description
1	VCC	10	VCC
2	USB_DATA-	11	USB_DATA-
3	USB_DATA+	12	USB_DATA+
4	GND	13	GND
5	USB3_RX-	14	USB3_RX-
6	USB3_RX+	15	USB3_RX+
7	GND	16	GND
8	USB3_TX-	17	USB3_TX-
9	USB3_TX+	18	USB3_TX+

Table 3-36: USB 3.0 Port Pinouts

3.3.5 Serial Port Connectors (COM1 and COM2)

- CN Label:** COM1
- CN Type:** D-sub 9
- CN Location:** See **Figure 3-29**
- CN Pinouts:** See **Table 3-37** and **Figure 3-34**

KINO-DBT Mini-ITX SBC

The serial port connects to a RS-232 serial communications device.

Pin	Description	Pin	Description
1	DCD	6	DSR
2	RX	7	RTS
3	TX	8	CTS
4	DTR	9	RI
5	GND		

Table 3-37: Serial Port Pinouts

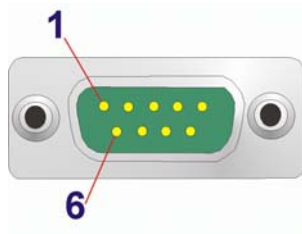

Figure 3-34: Serial Port Pinouts

3.3.6 VGA Connector

CN Label: CRT1

CN Type: D-sub 15 female

CN Location: See **Figure 3-29**

CN Pinouts: See **Table 3-38** and **Figure 3-35**

The VGA connector can be connected to monitors that accept standard VGA input for easy dual display setup. The VGA connector supports up to 2560 x 1600 resolutions.

PIN	DESCRIPTION	PIN	DESCRIPTION
V1	RED	V2	GREEN
V3	BLUE	V4	NC
V5	GND	V6	GND
V7	GND	V8	GND
V9	VCC	V10	GND
V11	NC	V12	DCCDA

V13	HSYNC	V14	VSYNC
V15	DDCCLK		

Table 3-38: VGA Connector Pinouts

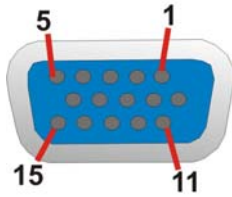

Figure 3-35: VGA Connector

Chapter

4

Installation

4.1 Anti-static Precautions



WARNING:

Failure to take ESD precautions during the installation of the KINO-DBT may result in permanent damage to the KINO-DBT and severe injury to the user.

Electrostatic discharge (ESD) can cause serious damage to electronic components, including the KINO-DBT. Dry climates are especially susceptible to ESD. It is therefore critical that whenever the KINO-DBT or any other electrical component is handled, the following anti-static precautions are strictly adhered to.

- **Wear an anti-static wristband:** - Wearing a simple anti-static wristband can help to prevent ESD from damaging the board.
- **Self-grounding:**- Before handling the board touch any grounded conducting material. During the time the board is handled, frequently touch any conducting materials that are connected to the ground.
- **Use an anti-static pad:** When configuring the KINO-DBT, place it on an anti-static pad. This reduces the possibility of ESD damaging the KINO-DBT.
- **Only handle the edges of the PCB:-:** When handling the PCB, hold the PCB by the edges.

4.2 Installation Considerations



NOTE:

The following installation notices and installation considerations should be read and understood before installation. All installation notices must be strictly adhered to. Failing to adhere to these precautions may lead to severe damage and injury to the person performing the installation.

KINO-DBT Mini-ITX SBC



WARNING:

The installation instructions described in this manual should be carefully followed in order to prevent damage to the components and injury to the user.

Before and during the installation please **DO** the following:

- Read the user manual:
 - The user manual provides a complete description of the KINO-DBT installation instructions and configuration options.
- Wear an electrostatic discharge cuff (ESD):
 - Electronic components are easily damaged by ESD. Wearing an ESD cuff removes ESD from the body and helps prevent ESD damage.
- Place the KINO-DBT on an antistatic pad:
 - When installing or configuring the motherboard, place it on an antistatic pad. This helps to prevent potential ESD damage.
- Turn all power to the KINO-DBT off:
 - When working with the KINO-DBT, make sure that it is disconnected from all power supplies and that no electricity is being fed into the system.

Before and during the installation of the KINO-DBT **DO NOT:**

- Remove any of the stickers on the PCB board. These stickers are required for warranty validation.
- Use the product before verifying all the cables and power connectors are properly connected.
- Allow screws to come in contact with the PCB circuit, connector pins, or its components.

4.2.1 SO-DIMM Installation

To install an SO-DIMM, please follow the steps below and refer to Figure 4-1.

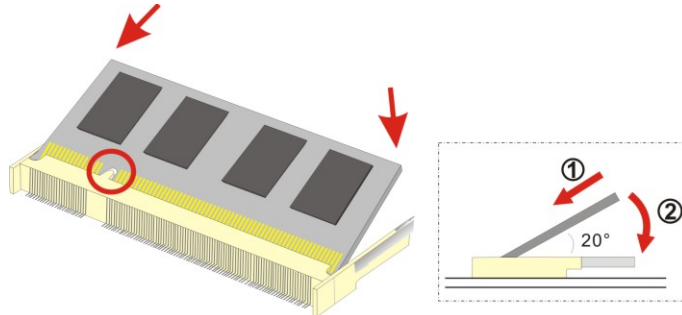

Figure 4-1: SO-DIMM Installation

- Step 1:** Locate the **SO-DIMM socket** on the solder side of the KINO-DBT. Place the board on an anti-static mat.
- Step 2:** Align the **SO-DIMM with the socket**. Align the notch on the memory with the notch on the memory socket.
- Step 3:** Insert the **SO-DIMM**. Push the memory in at a 20° angle. (See **Figure 4-1**)
- Step 4:** Seat the **SO-DIMM**. Gently push downwards and the arms clip into place. (See **Figure 4-1**)

4.2.2 PCIe Mini Card Installation

To install the PCIe Mini card, please refer to the diagram and instructions below.



NOTE:

The PCIe Mini card slot supports full-size and half-size PCIe Mini cards. The following instruction diagrams take full-size cards as an example to show users how to install. To install a half-size card, please remove the corresponding retention screw.

KINO-DBT Mini-ITX SBC

- Step 1:** Locate the PCIe Mini card slot. Remove the preinstalled retention screw on the screw pillar of the PCIe Mini card slot as shown in **(Figure 4-2)**.

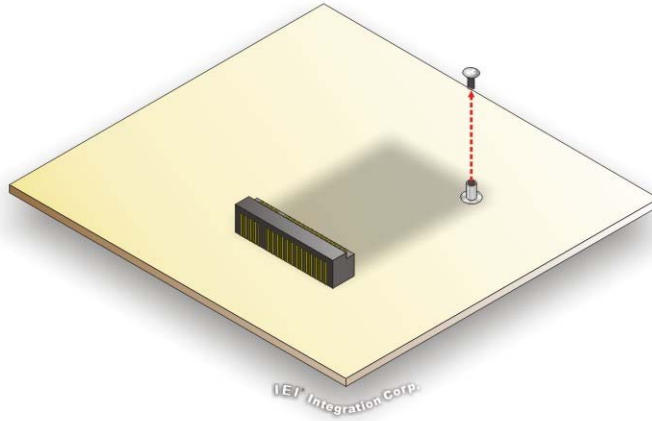

Figure 4-2: PCIe Mini Card Retention Screw Removal

- Step 2:** Line up the notch on the PCIe Mini card with the notch on the connector. Slide the PCIe Mini card into the socket at an angle of about 20°.
- Step 3:** Push the other end of the PCIe Mini card down and secure the card with the previously removed retention screw **(Figure 4-3)**.

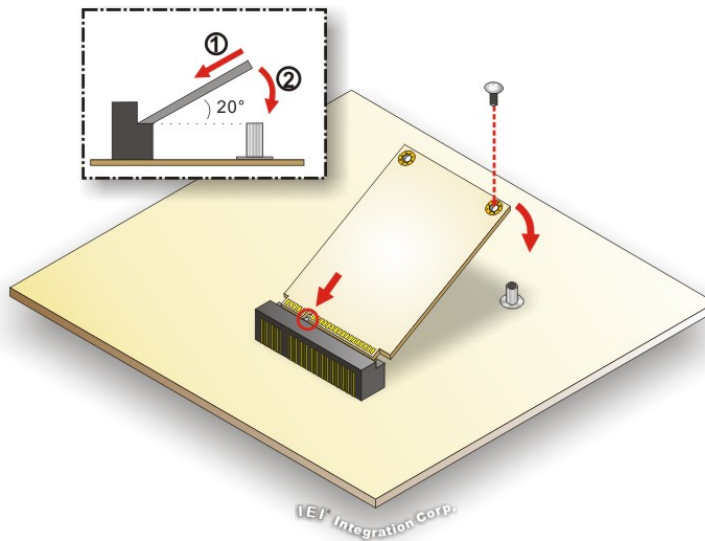

Figure 4-3: PCIe Mini Card Installation (Full-size)

4.3 System Configuration

The KINO-DBT is a jumperless single board computer. The system configuration is controlled by buttons and switches. The system configuration must be performed before installation.

4.3.1 AT/ATX Power Mode Setting

The AT and ATX power mode selection is made through the AT/ATX power mode switch which is shown in **Figure 4-4**.

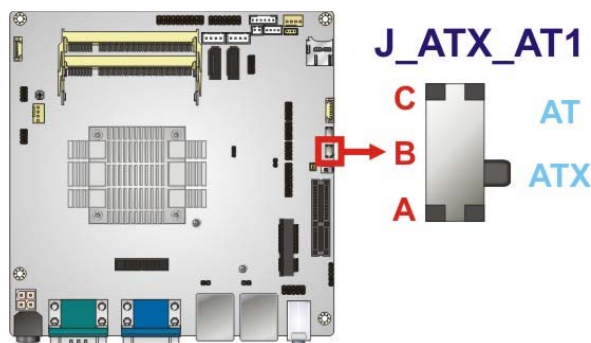

Figure 4-4: AT/ATX Power Mode Switch Location

4.3.2 Clear CMOS Button

To reset the BIOS, remove the on-board battery and press the clear CMOS button for three seconds or more. The clear CMOS button location is shown in **Figure 4-5**.

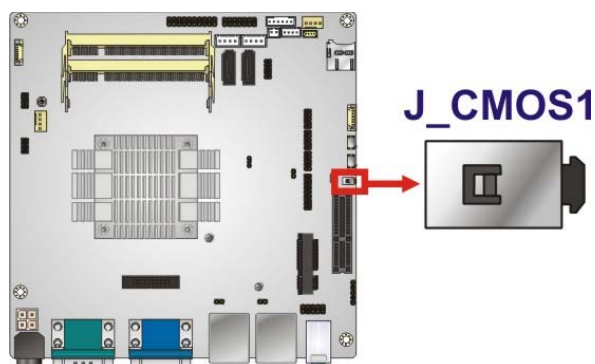

Figure 4-5: Clear CMOS Button Location

KINO-DBT Mini-ITX SBC

4.3.3 Flash Descriptor Security Override

The Flash Descriptor Security Override jumper (J_FLASH1) specifies whether to override the flash descriptor.

Setting	Description
Short 1-2	No override
Short 2-3	Override

Table 4-1: Flash Descriptor Security Override Jumper Settings

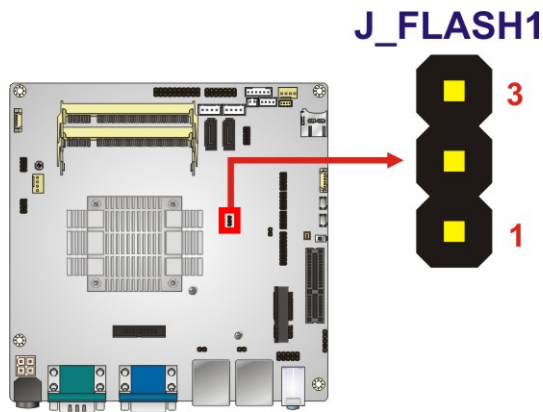

Figure 4-6: Flash Descriptor Security Override Jumper Location

4.3.4 mSATA/SATA Selection

Use the J_SATA1 switch to select whether to automatically detect mSATA devices.

Setting	Description
A-B	Automatically detect mSATA device (Default)
B-C	Enable mSATA device

Table 4-2: mSATA/SATA Switch Settings

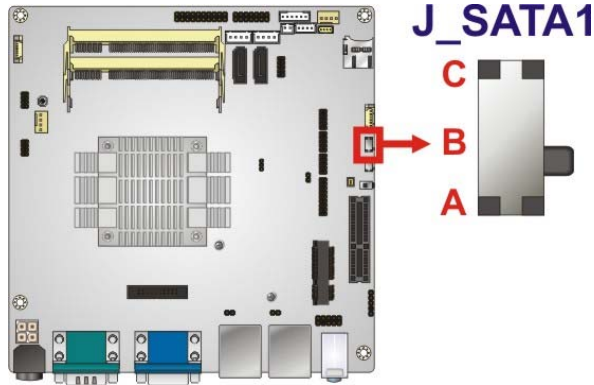

Figure 4-7: mSATA/SATA Switch Location

4.3.5 USB Power Select

The USB power selection is made through the BIOS options in “Chipset → South Bridge” BIOS menu. Use the **USB SW1** and the **USB SW2** BIOS options to configure the power source to the corresponding USB ports (see **Table 4-3**).

BIOS Options	Configured USB Ports
USB SW1	LAN1_USB1 (external USB 3.0 ports) LAN2_USB2 (external USB 2.0 ports)
USB SW2	USB1, USB2 (internal USB 2.0 ports)

Table 4-3: BIOS Options and Configured USB Ports

Please refer to **Section 5.4.2** for detailed information.

4.4 Internal Peripheral Device Connections

This section outlines the installation of peripheral devices to the on-board connectors.

4.4.1 SATA Drive Connection

The KINO-DBT is shipped with one SATA drive cable. To connect the SATA drive to the connector, please follow the steps below.

Step 1: Locate the **SATA connector** and the **SATA power connector**. The locations of the connectors are shown in **Chapter 3**.

KINO-DBT Mini-ITX SBC

Step 2: **Insert the cable connector.** Insert the cable connector into the on-board SATA drive connector and the SATA power connector. See **Figure 4-8**.

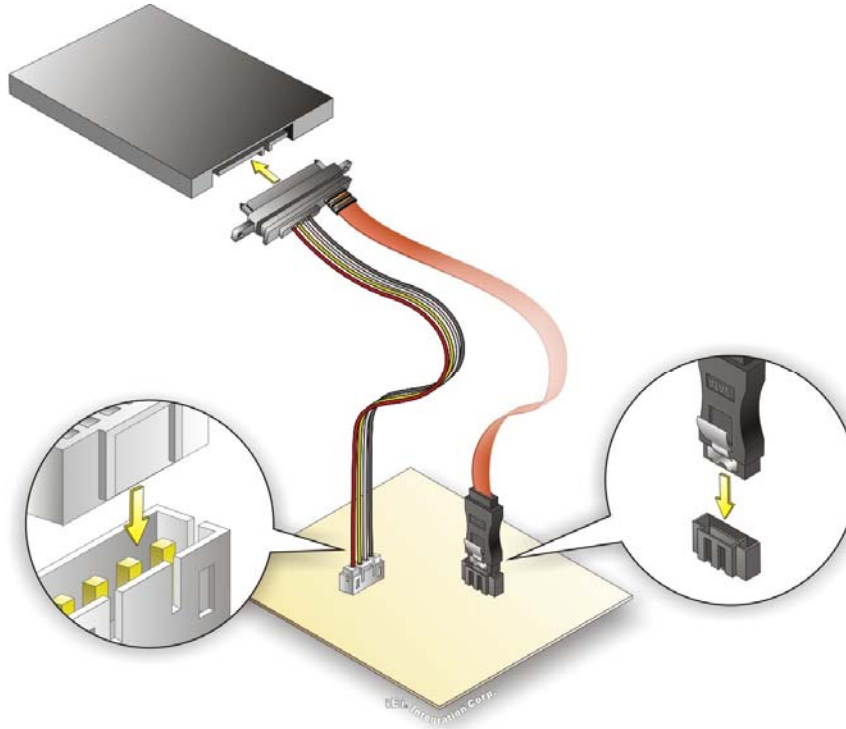

Figure 4-8: SATA Drive Cable Connection

Step 3: **Connect the cable to the SATA disk.** Connect the connector on the other end of the cable to the connector at the back of the SATA drive. See **Figure 4-8**.

Step 4: To remove the SATA cable from the SATA connector, press the clip on the connector at the end of the cable.

4.4.2 USB Cable Connection

The KINO-DBT is shipped with a dual port USB 2.0 cable. To connect the USB cable connector, please follow the steps below.

Step 1: **Locate the connectors.** The locations of the USB connectors are shown in **Chapter 3**.

**WARNING:**

If the USB pins are not properly aligned, the USB device can burn out.

Step 2: Align the connectors. The cable has two connectors. Correctly align pin 1 on each cable connector with pin 1 on the KINO-DBT USB connector.

Step 3: Insert the cable connectors. Once the cable connectors are properly aligned with the USB connectors on the KINO-DBT, connect the cable connectors to the on-board connectors. See Figure 4-9.

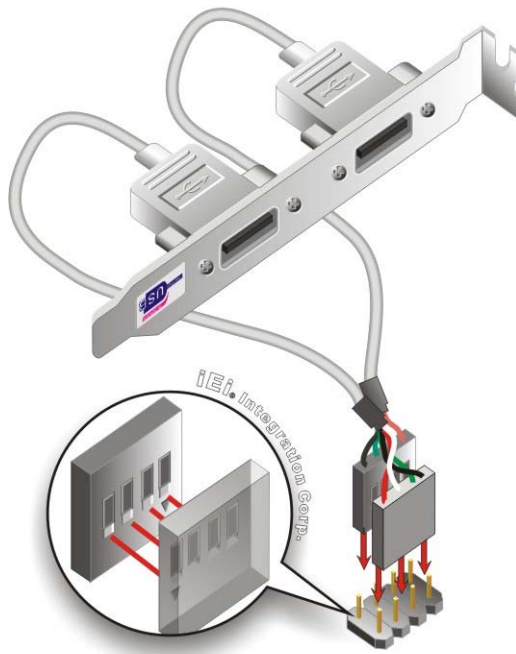

Figure 4-9: Dual USB Cable Connection

Step 4: Attach the bracket to the chassis. The USB 2.0 connectors are attached to a bracket. To secure the bracket to the chassis please refer to the installation instructions that came with the chassis.

Chapter

5

BIOS

5.1 Introduction

The BIOS is programmed onto the BIOS chip. The BIOS setup program allows changes to certain system settings. This chapter outlines the options that can be changed.



NOTE:

Some of the BIOS options may vary throughout the life cycle of the product and are subject to change without prior notice.

5.1.1 Starting Setup

The UEFI BIOS is activated when the computer is turned on. The setup program can be activated in one of two ways.

1. Press the **DEL** or **F2** key as soon as the system is turned on or
2. Press the **DEL** or **F2** key when the “**Press DEL or F2 to enter SETUP**” message appears on the screen.

If the message disappears before the **DEL** or **F2** key is pressed, restart the computer and try again.

5.1.2 Using Setup

Use the arrow keys to highlight items, press **ENTER** to select, use the PageUp and PageDown keys to change entries, press **F1** for help and press **ESC** to quit. Navigation keys are shown in **Table 5-1**.

Key	Function
Up arrow	Move to previous item
Down arrow	Move to next item
Left arrow	Move to the item on the left hand side
Right arrow	Move to the item on the right hand side

KINO-DBT Mini-ITX SBC

Key	Function
+	Increase the numeric value or make changes
-	Decrease the numeric value or make changes
Esc key	Main Menu – Quit and not save changes into CMOS Status Page Setup Menu and Option Page Setup Menu -- Exit current page and return to Main Menu
F1 key	General help, only for Status Page Setup Menu and Option Page Setup Menu
F2 key	Load previous values
F3 key	Load optimized defaults
F4 key	Save changes and Exit BIOS

Table 5-1: BIOS Navigation Keys

5.1.3 Getting Help

When **F1** is pressed a small help window describing the appropriate keys to use and the possible selections for the highlighted item appears. To exit the Help Window press **Esc** or the **F1** key again.

5.1.4 Unable to Reboot after Configuration Changes

If the computer cannot boot after changes to the system configuration is made, CMOS defaults. Use the clear CMOS button described in **Chapter 4**.

5.1.5 BIOS Menu Bar

The **menu bar** on top of the BIOS screen has the following main items:

- Main – Changes the basic system configuration.
- Advanced – Changes the advanced system settings.
- Chipset – Changes the chipset settings.
- Boot – Changes the system boot configuration.

- Security – Sets User and Supervisor Passwords.
- Save & Exit – Selects exit options and loads default settings

The following sections completely describe the configuration options found in the menu items at the top of the BIOS screen and listed above.

5.2 Main

The **Main** BIOS menu (**BIOS Menu 1**) appears when the **BIOS Setup** program is entered.

The **Main** menu gives an overview of the basic system information.

Aptio Setup Utility - Copyright (C) 2013 American Megatrends, Inc.					
Main	Advanced	Chipset	Security	Boot	Save & Exit
BIOS Information					Set the Date. Use Tab to switch between Data elements.
BIOS Vendor			American Megatrends		
Core Version			5.009		
Compliancy			UEFI 2.3;PI1.2		
Project Version			B328AM10.ROM		
Build Date and Time			11/11/2014 17:47:24		
iWDD Vendor			iEi		
iWDD Version			B328ET13.bin		
Memory Information					
Total Memory			4096 MB (LPDDR3)		
TXE Information					
Sec RC Version			00.05.00.00		←→: Select Screen
TXE FW Version			01.00.02.1060		↑ ↓: Select Item
System Date			[Tue 01/13/2010]		EnterSelect
System Time			[15:10:27]		+ -: Change Opt.
Access Level			Administrator		F1: General Help
					F2: Previous Values
					F3: Optimized Defaults
					F4: Save & Exit
					ESC: Exit
Version 2.16.1242. Copyright (C) 2013 American Megatrends, Inc.					

BIOS Menu 1: Main

→ BIOS Information

The **BIOS Information** lists a brief summary of the BIOS. The fields in **BIOS Information** cannot be changed. The items shown in the system overview include:

- **BIOS Vendor:** Installed BIOS vendor
- **Core Version:** Current BIOS version

KINO-DBT Mini-ITX SBC

- **Compliance:** Current compliant version
- **Project Version:** the board version
- **Build Date and Time:** Date and time the current BIOS version was made

→ Memory Information

The **Memory Information** lists a brief summary of the system memory. The fields in **Memory Information** cannot be changed. The items shown in the system overview include:

- **Total Memory:** Current total memory of the system

→ TXE Information

The **TXE Information** lists a brief summary of Intel® Trusted Execution Engine (TXE). The fields in **TXE Information** cannot be changed. The items shown in the system overview include:

- **Sec RC Version:** Current sec reference code version
- **TXE FW Version:** Current Intel® TXE firmware version

The System Overview field has two user configurable fields:

→ System Date [xx/xx/xx]

Use the **System Date** option to set the system date. Manually enter the day, month and year.

→ System Time [xx:xx:xx]

Use the **System Time** option to set the system time. Manually enter the hours, minutes and seconds.

5.3 Advanced

Use the **Advanced** menu (**BIOS Menu 2**) to configure the CPU and peripheral devices through the following sub-menus:



WARNING!

Setting the wrong values in the sections below may cause the system to malfunction. Make sure that the settings made are compatible with the hardware.

```

Aptio Setup Utility - Copyright (C) 2013 American Megatrends, Inc.
Main  Advanced  Chipset  Security  Boot  Save & Exit
-----
> ACPI Settings
> Super IO Configuration
> iWDD Hardware Monitor
> RTC Wake Settings
> Serial Port Console Redirection
> CPU Configuration
> IDE Configuration
> Trusted Computing
> USB Configuration

System ACPI Parameters
-----
<->: Select Screen
↑ ↓: Select Item
Enter>Select
+ - Change Opt.
F1 General Help
F2 Previous Values
F3 Optimized Defaults
F4 Save & Exit
ESC Exit

Version 2.16.1242. Copyright (C) 2013 American Megatrends, Inc.
    
```

BIOS Menu 2: Advanced

5.3.1 ACPI Settings

The **ACPI Settings** menu (**BIOS Menu 3**) configures the Advanced Configuration and Power Interface (ACPI) options.

KINO-DBT Mini-ITX SBC

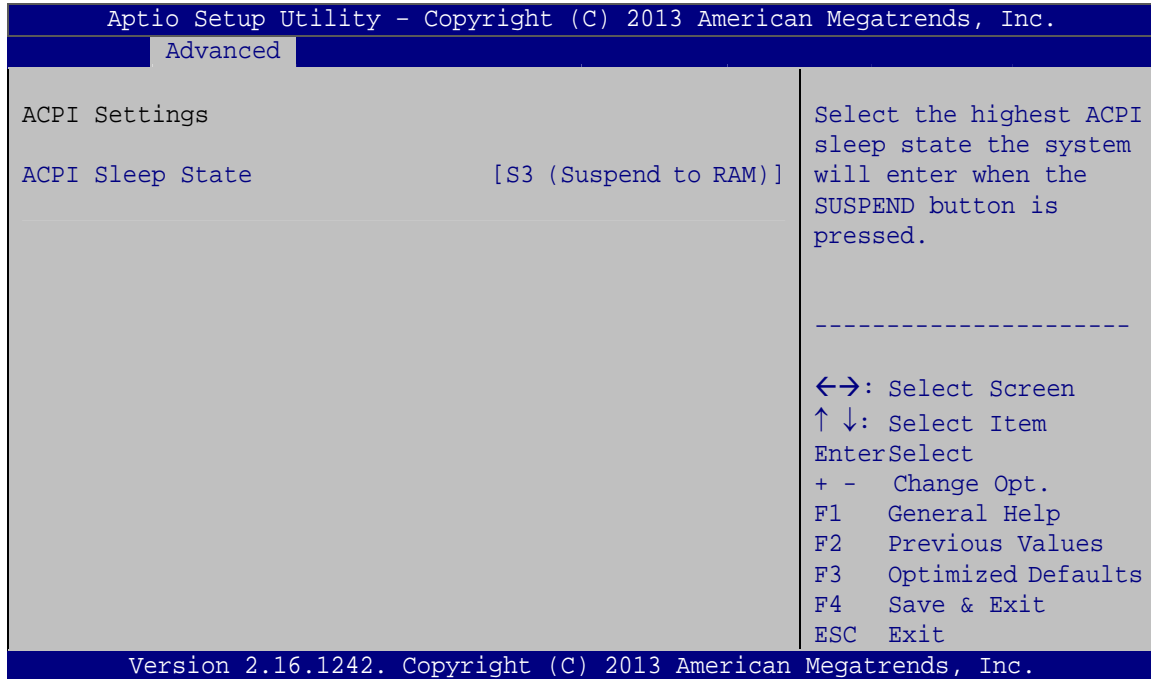

BIOS Menu 3: ACPI Configuration

→ ACPI Sleep State [S3 (Suspend to RAM)]

Use the **ACPI Sleep State** option to specify the sleep state the system enters when it is not being used.

- **S3 (Suspend to DEFAULT RAM)** The caches are flushed and the CPU is powered off. Power to the RAM is maintained. The computer returns slower to a working state, but more power is saved.

5.3.2 Super IO Configuration

Use the **Super IO Configuration** menu (**BIOS Menu 4**) to set or change the configurations for the serial ports.

```

Aptio Setup Utility - Copyright (C) 2013 American Megatrends, Inc.
  Advanced
-----
Super IO Configuration                               Set Parameters of Serial
                                                    Port 1 (COMA)
                                                    -----
Super IO Chip                                     F81866
> Serial Port 1 Configuration
> Serial Port 2 Configuration
> Serial Port 3 Configuration
> Serial Port 4 Configuration
> Serial Port 5 Configuration
> Serial Port 6 Configuration
                                                    <->: Select Screen
                                                    ↑ ↓: Select Item
                                                    EnterSelect
                                                    + - Change Opt.
F1  General Help
F2  Previous Values
F3  Optimized Defaults
F4  Save & Exit
ESC Exit
Version 2.16.1242. Copyright (C) 2013 American Megatrends, Inc.
    
```

BIOS Menu 4: Super IO Configuration

5.3.2.1 Serial Port n Configuration

Use the **Serial Port n Configuration** menu (**BIOS Menu 5**) to configure the serial port n.

```

Aptio Setup Utility - Copyright (C) 2013 American Megatrends, Inc.
  Advanced
-----
Serial Port n Configuration                       Enable or Disable Serial
                                                    Port (COM)
                                                    -----
Serial Port                                     [Enabled]
Device Settings                                IO=3F8h;IRQ=4
Change Settings                                [Auto]
                                                    <->: Select Screen
                                                    ↑ ↓: Select Item
                                                    EnterSelect
                                                    = - Change Opt.
F1  General Help
F2  Previous Values
F3  Optimized Defaults
F4  Save & Exit
ESC Exit
Version 2.16.1242. Copyright (C) 2013 American Megatrends, Inc.
    
```

BIOS Menu 5: Serial Port n Configuration Menu

KINO-DBT Mini-ITX SBC

5.3.2.1.1 Serial Port 1 Configuration

→ Serial Port [Enabled]

Use the **Serial Port** option to enable or disable the serial port.

- **Disabled** Disable the serial port
- **Enabled** **DEFAULT** Enable the serial port

→ Change Settings [Auto]

Use the **Change Settings** option to change the serial port IO port address and interrupt address.

- **Auto** **DEFAULT** The serial port IO port address and interrupt address are automatically detected.
- **IO=3F8h;**
IRQ=4 Serial Port I/O port address is 3F8h and the interrupt address is IRQ4
- **IO=3F8h;**
IRQ=3, 4,
5, 6, 7, 9,
10, 11, 12 Serial Port I/O port address is 3F8h and the interrupt address is IRQ3, 4, 5, 6, 7, 9, 10, 11, 12
- **IO=2F8h;**
IRQ=3, 4,
5, 6, 7, 9,
10, 11, 12 Serial Port I/O port address is 2F8h and the interrupt address is IRQ3, 4, 5, 6, 7, 9, 10, 11, 12
- **IO=3E8h;**
IRQ=3, 4,
5, 6, 7, 9,
10, 11, 12 Serial Port I/O port address is 3E8h and the interrupt address is IRQ3, 4, 5, 6, 7, 9, 10, 11, 12
- **IO=2E8h;**
IRQ=3, 4,
5, 6, 7, 9,
10, 11, 12 Serial Port I/O port address is 2E8h and the interrupt address is IRQ3, 4, 5, 6, 7, 9, 10, 11, 12

5.3.2.1.2 Serial Port 2 Configuration

→ **Serial Port [Enabled]**

Use the **Serial Port** option to enable or disable the serial port.

- **Disabled** Disable the serial port
- **Enabled** **DEFAULT** Enable the serial port

→ **Change Settings [Auto]**

Use the **Change Settings** option to change the serial port IO port address and interrupt address.

- **Auto** **DEFAULT** The serial port IO port address and interrupt address are automatically detected.
- **IO=2F8h;**
IRQ=3 Serial Port I/O port address is 2F8h and the interrupt address is IRQ3
- **IO=3F8h;**
IRQ=3, 4,
5, 6, 7, 9,
10, 11, 12 Serial Port I/O port address is 3F8h and the interrupt address is IRQ3, 4, 5, 6, 7, 9, 10, 11, 12
- **IO=2F8h;**
IRQ=3, 4,
5, 6, 7, 9,
10, 11, 12 Serial Port I/O port address is 2F8h and the interrupt address is IRQ3, 4, 5, 6, 7, 9, 10, 11, 12
- **IO=3E8h;**
IRQ=3, 4,
5, 6, 7, 9,
10, 11, 12 Serial Port I/O port address is 3E8h and the interrupt address is IRQ3, 4, 5, 6, 7, 9, 10, 11, 12

KINO-DBT Mini-ITX SBC

- **IO=2E8h;**
IRQ=3, 4,
5, 6, 7, 9,
10, 11, 12 Serial Port I/O port address is 2E8h and the interrupt address is IRQ3, 4, 5, 6, 7, 9, 10, 11, 12

5.3.2.1.3 Serial Port 3 Configuration

→ Serial Port [Enabled]

Use the **Serial Port** option to enable or disable the serial port.

- **Disabled** Disable the serial port
- **Enabled** **DEFAULT** Enable the serial port

→ Change Settings [Auto]

Use the **Change Settings** option to change the serial port IO port address and interrupt address.

- **Auto** **DEFAULT** The serial port IO port address and interrupt address are automatically detected.
- **IO=3E8h;**
IRQ=10 Serial Port I/O port address is 3E8h and the interrupt address is IRQ10
- **IO=3F8h;**
IRQ=3, 4,
5, 6, 7, 9,
10, 11, 12 Serial Port I/O port address is 3F8h and the interrupt address is IRQ3, 4, 5, 6, 7, 9, 10, 11, 12
- **IO=2F8h;**
IRQ=3, 4,
5, 6, 7, 9,
10, 11, 12 Serial Port I/O port address is 2F8h and the interrupt address is IRQ3, 4, 5, 6, 7, 9, 10, 11, 12

- **IO=3E8h;**
IRQ=3, 4,
5, 6, 7, 9,
10, 11, 12 Serial Port I/O port address is 3E8h and the interrupt address is IRQ3, 4, 5, 6, 7, 9, 10, 11, 12

- **IO=2E8h;**
IRQ=3, 4,
5, 6, 7, 9,
10, 11, 12 Serial Port I/O port address is 2E8h and the interrupt address is IRQ3, 4, 5, 6, 7, 9, 10, 11, 12

- **IO=2F0h;**
IRQ=3, 4,
5, 6, 7, 9,
10, 11, 12 Serial Port I/O port address is 2F0h and the interrupt address is IRQ3, 4, 5, 6, 7, 9, 10, 11, 12

- **IO=2E0h;**
IRQ=3, 4,
5, 6, 7, 9,
10, 11, 12 Serial Port I/O port address is 2E0h and the interrupt address is IRQ3, 4, 5, 6, 7, 9, 10, 11, 12

5.3.2.1.4 Serial Port 4 Configuration

→ Serial Port [Enabled]

Use the **Serial Port** option to enable or disable the serial port.

- **Disabled** Disable the serial port
- **Enabled** **DEFAULT** Enable the serial port

→ Change Settings [Auto]

Use the **Change Settings** option to change the serial port IO port address and interrupt address.

- **Auto** **DEFAULT** The serial port IO port address and interrupt address are automatically detected.

KINO-DBT Mini-ITX SBC

- ➔ **IO=2E8h;**
IRQ=10 Serial Port I/O port address is 2E8h and the interrupt address is IRQ10
- ➔ **IO=3F8h;**
IRQ=3, 4,
5, 6, 7, 9,
10, 11, 12 Serial Port I/O port address is 3F8h and the interrupt address is IRQ3, 4, 5, 6, 7, 9, 10, 11, 12
- ➔ **IO=2F8h;**
IRQ=3, 4,
5, 6, 7, 9,
10, 11, 12 Serial Port I/O port address is 2F8h and the interrupt address is IRQ3, 4, 5, 6, 7, 9, 10, 11, 12
- ➔ **IO=3E8h;**
IRQ=3, 4,
5, 6, 7, 9,
10, 11, 12 Serial Port I/O port address is 3E8h and the interrupt address is IRQ3, 4, 5, 6, 7, 9, 10, 11, 12
- ➔ **IO=2E8h;**
IRQ=3, 4,
5, 6, 7, 9,
10, 11, 12 Serial Port I/O port address is 2E8h and the interrupt address is IRQ3, 4, 5, 6, 7, 9, 10, 11, 12
- ➔ **IO=2F0h;**
IRQ=3, 4,
5, 6, 7, 9,
10, 11, 12 Serial Port I/O port address is 2F0h and the interrupt address is IRQ3, 4, 5, 6, 7, 9, 10, 11, 12
- ➔ **IO=2E0h;**
IRQ=3, 4,
5, 6, 7, 9,
10, 11, 12 Serial Port I/O port address is 2E0h and the interrupt address is IRQ3, 4, 5, 6, 7, 9, 10, 11, 12

5.3.2.1.5 Serial Port 5 Configuration

➔ Serial Port [Enabled]

Use the **Serial Port** option to enable or disable the serial port.

- Disabled Disable the serial port
- Enabled **DEFAULT** Enable the serial port

→ **Change Settings [Auto]**

Use the **Change Settings** option to change the serial port IO port address and interrupt address.

- **Auto** **DEFAULT** The serial port IO port address and interrupt address are automatically detected.
- **IO=2D0h;**
IRQ=11 Serial Port I/O port address is 2D0h and the interrupt address is IRQ11
- **IO=3F8h;**
IRQ=3, 4,
5, 6, 7, 9,
10, 11, 12 Serial Port I/O port address is 3F8h and the interrupt address is IRQ3, 4, 5, 6, 7, 9, 10, 11, 12
- **IO=2F8h;**
IRQ=3, 4,
5, 6, 7, 9,
10, 11, 12 Serial Port I/O port address is 2F8h and the interrupt address is IRQ3, 4, 5, 6, 7, 9, 10, 11, 12
- **IO=3E8h;**
IRQ=3, 4,
5, 6, 7, 9,
10, 11, 12 Serial Port I/O port address is 3E8h and the interrupt address is IRQ3, 4, 5, 6, 7, 9, 10, 11, 12
- **IO=2E8h;**
IRQ=3, 4,
5, 6, 7, 9,
10, 11, 12 Serial Port I/O port address is 2E8h and the interrupt address is IRQ3, 4, 5, 6, 7, 9, 10, 11, 12
- **IO=2F0h;**
IRQ=3, 4,
5, 6, 7, 9,
10, 11, 12 Serial Port I/O port address is 2F0h and the interrupt address is IRQ3, 4, 5, 6, 7, 9, 10, 11, 12

KINO-DBT Mini-ITX SBC

- ➔ **IO=2E0h;** Serial Port I/O port address is 2E0h and the interrupt
IRQ=3, 4, address is IRQ3, 4, 5, 6, 7, 9, 10, 11, 12
5, 6, 7, 9,
10, 11, 12

5.3.2.1.6 Serial Port 6 Configuration➔ **Serial Port [Enabled]**

Use the **Serial Port** option to enable or disable the serial port.

- ➔ **Disabled** Disable the serial port
- ➔ **Enabled DEFAULT** Enable the serial port

➔ **Change Settings [Auto]**

Use the **Change Settings** option to change the serial port IO port address and interrupt address.

- ➔ **Auto DEFAULT** The serial port IO port address and interrupt address
are automatically detected.
- ➔ **IO=2D8h;** Serial Port I/O port address is 2D8h and the interrupt
IRQ=11 address is IRQ11
- ➔ **IO=3F8h;** Serial Port I/O port address is 3F8h and the interrupt
IRQ=3, 4, address is IRQ3, 4, 5, 6, 7, 9, 10, 11, 12
5, 6, 7, 9,
10, 11, 12
- ➔ **IO=2F8h;** Serial Port I/O port address is 2F8h and the interrupt
IRQ=3, 4, address is IRQ3, 4, 5, 6, 7, 9, 10, 11, 12
5, 6, 7, 9,
10, 11, 12

- IO=3E8h; Serial Port I/O port address is 3E8h and the interrupt address is IRQ3, 4, 5, 6, 7, 9, 10, 11, 12
 IRQ=3, 4,
 5, 6, 7, 9,
 10, 11, 12
- IO=2E8h; Serial Port I/O port address is 2E8h and the interrupt address is IRQ3, 4, 5, 6, 7, 9, 10, 11, 12
 IRQ=3, 4,
 5, 6, 7, 9,
 10, 11, 12
- IO=2F0h; Serial Port I/O port address is 2F0h and the interrupt address is IRQ3, 4, 5, 6, 7, 9, 10, 11, 12
 IRQ=3, 4,
 5, 6, 7, 9,
 10, 11, 12
- IO=2E0h; Serial Port I/O port address is 2E0h and the interrupt address is IRQ3, 4, 5, 6, 7, 9, 10, 11, 12
 IRQ=3, 4,
 5, 6, 7, 9,
 10, 11, 12

5.3.3 iWDD Hardware Monitor

The **iWDD Hardware Monitor** menu (**BIOS Menu 6**) contains the fan configuration submenus and displays operating temperature and system voltages.

KINO-DBT Mini-ITX SBC

```

Aptio Setup Utility - Copyright (C) 2013 American Megatrends, Inc.
Advanced
PC Health Status
CPU temperature           :+34 °C
System temperature       :+31 °C

CPU_FAN1 Speed           :N/A
SYS_FAN1 Speed           :N/A

CPU_CORE                 :+0.815 V
+5V                      :+5.208 V
+DDR                     :+1.354 V
+3.3VSB                  :+3.259 V

> Smart Fan Mode Configuration

Smart Fan Mode Select

-----
<=>: Select Screen
↑↓: Select Item
Enter>Select
+ - Change Opt.
F1  General Help
F2  Previous Values
F3  Optimized Defaults
F4  Save & Exit
ESC Exit

Version 2.16.1242. Copyright (C) 2013 American Megatrends, Inc.

```

BIOS Menu 6: iWDD Hardware Monitor**→ PC Health Status**

The following system parameters and values are shown. The system parameters that are monitored are:

- System Temperatures:
 - CPU Temperature
 - System Temperature
- Fan Speeds:
 - CPU Fan
 - System Fan
- Voltages:
 - CPU_CORE
 - +5V
 - +DDR
 - +3.3VSB

5.3.3.1 Smart Fan Mode Configuration

Use the **Smart Fan Mode Configuration** submenu (**BIOS Menu 7**) to configure smart fan temperature and speed settings.

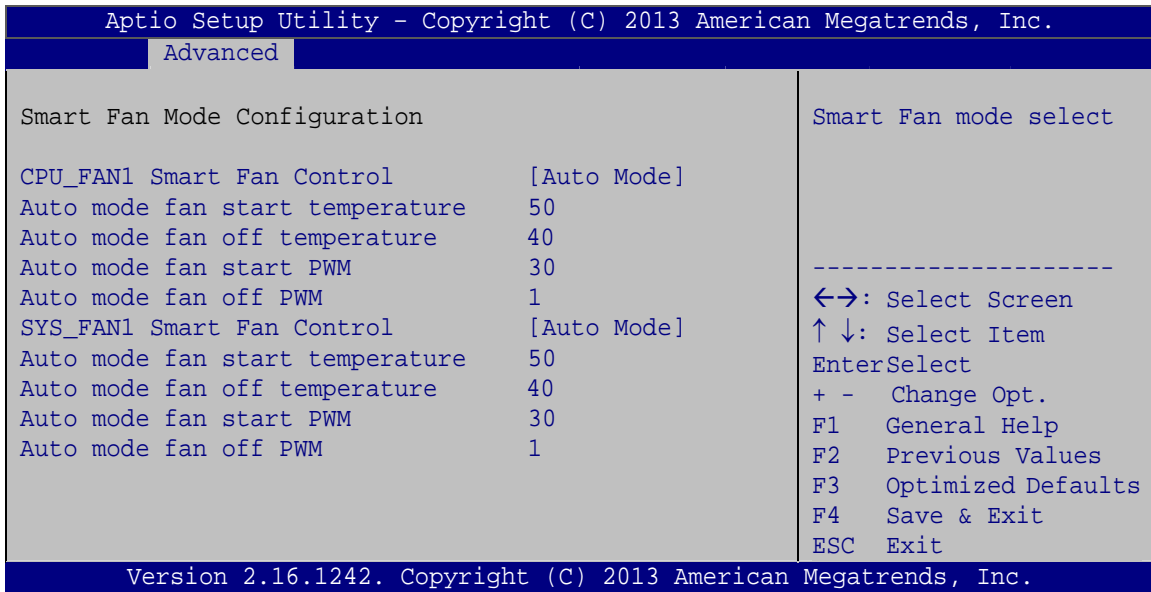

BIOS Menu 7: Smart Fan Function

→ CPU_FAN1 Smart Fan Control [Auto Mode]

Use the **CPU_FAN1 Smart Fan Control** option to configure the CPU smart fan.

→ **Manual Mode** The fan spins at the speed set in Manual Mode settings.

→ **Auto Mode** **DEFAULT** The fan adjusts its speed using Auto Mode settings.

→ SYS_FAN1 Smart Fan Control [Auto Mode]

Use the **SYS_FAN1 Smart Fan Control** option to configure the system smart fan.

→ **Manual Mode** The fan spins at the speed set in Manual Mode settings.

KINO-DBT Mini-ITX SBC

→ **Auto Mode** **DEFAULT** The fan adjusts its speed using Auto Mode settings.

→ **Auto mode fan start temperature**

Use the + or – key to change the **Auto mode fan start temperature** value. Enter a decimal number between 1 and 100.

→ **Auto mode fan off temperature**

Use the + or – key to change the **Auto mode fan off temperature** value. Enter a decimal number between 1 and 100.

→ **Auto mode fan start PWM**

Use the + or – key to change the **Auto mode fan start PWM** value. Enter a decimal number between 1 and 100.

→ **Auto mode fan start slope PWM**

Use the + or – key to change the **Auto mode fan start slope PWM** value. Enter a decimal number between 1 and 8.

5.3.4 RTC Wake Settings

The **RTC Wake Settings** menu (**BIOS Menu 8**) configures RTC wake event. The RTC wake function is supported in ACPI (S3/S4/S5) and APM soft off modes.

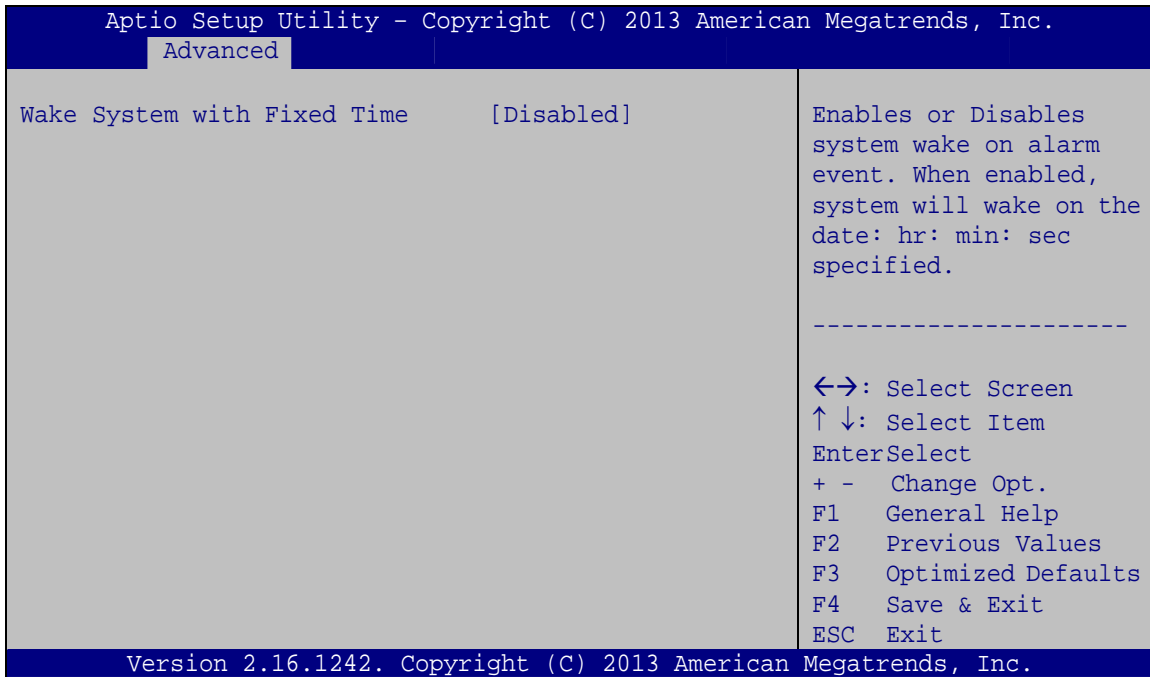

BIOS Menu 8: RTC Wake Settings

→ Wake System with Fixed Time [Disabled]

Use the **Wake System with Fixed Time** option to specify the time the system should be roused from a suspended state.

- **Disabled** **DEFAULT** The real time clock (RTC) cannot generate a wake event

KINO-DBT Mini-ITX SBC

➔ **Enabled**

If selected, the following appears with values that can be selected:

*Wake up every day

*Wake up date

*Wake up hour

*Wake up minute

*Wake up second

After setting the alarm, the computer turns itself on from a suspend state when the alarm goes off.

5.3.5 Serial Port Console Redirection

The **Serial Port Console Redirection** menu (**BIOS Menu 9**) allows the console redirection options to be configured. Console redirection allows users to maintain a system remotely by re-directing keyboard input and text output through the serial port.

```

Aptio Setup Utility - Copyright (C) 2013 American Megatrends, Inc.
  Advanced
-----
COM1
  Console Redirection      [Disabled]      Console Redirection
  > Console Redirection Settings      Enable or Disable

COM2
  Console Redirection      [Disabled]
  > Console Redirection Settings

COM3
  Console Redirection      [Disabled]
  > Console Redirection Settings

COM4
  Console Redirection      [Disabled]
  > Console Redirection Settings

COM5
  Console Redirection      [Disabled]
  > Console Redirection Settings

COM6
  Console Redirection      [Disabled]
  > Console Redirection Settings

-----
<->: Select Screen
↑↓: Select Item
Enter>Select
+/-: Change Opt.
F1   General Help
F2   Previous Values
F3   Optimized Defaults
F4   Save & Exit
ESC  Exit

Version 2.16.1242. Copyright (C) 2013 American Megatrends, Inc.
  
```

BIOS Menu 9: Serial Port Console Redirection

→ Console Redirection [Disabled]

Use **Console Redirection** option to enable or disable the console redirection function.

- **Disabled** **DEFAULT** Disabled the console redirection function
- **Enabled** Enabled the console redirection function

The following options are available in the **Console Redirection Settings** submenu when the Console Redirection option is enabled.

→ Terminal Type [ANSI]

Use the **Terminal Type** option to specify the remote terminal type.

- **VT100** The target terminal type is VT100
- **VT100+** The target terminal type is VT100+
- **VT-UTF8** The target terminal type is VT-UTF8
- **ANSI** **DEFAULT** The target terminal type is ANSI

→ Bits per second [115200]

Use the **Bits per second** option to specify the serial port transmission speed. The speed must match the other side. Long or noisy lines may require lower speeds.

- **9600** Sets the serial port transmission speed at 9600.
- **19200** Sets the serial port transmission speed at 19200.
- **38400** Sets the serial port transmission speed at 38400.
- **57600** Sets the serial port transmission speed at 57600.
- **115200** **DEFAULT** Sets the serial port transmission speed at 115200.

→ Data Bits [8]

Use the **Data Bits** option to specify the number of data bits.

- **7** Sets the data bits at 7.

KINO-DBT Mini-ITX SBC

→ **8** **DEFAULT** Sets the data bits at 8.

→ Parity [None]

Use the **Parity** option to specify the parity bit that can be sent with the data bits for detecting the transmission errors.

→ **None** **DEFAULT** No parity bit is sent with the data bits.

→ **Even** The parity bit is 0 if the number of ones in the data bits is even.

→ **Odd** The parity bit is 0 if the number of ones in the data bits is odd.

→ **Mark** The parity bit is always 1. This option does not provide error detection.

→ **Space** The parity bit is always 0. This option does not provide error detection.

→ Stop Bits [1]

Use the **Stop Bits** option to specify the number of stop bits used to indicate the end of a serial data packet. Communication with slow devices may require more than 1 stop bit.

→ **1** **DEFAULT** Sets the number of stop bits at 1.

→ **2** Sets the number of stop bits at 2.

5.3.6 CPU Configuration

Use the **CPU Configuration** BIOS menu (**BIOS Menu 10**) to view detailed CPU specifications and configure the CPU.

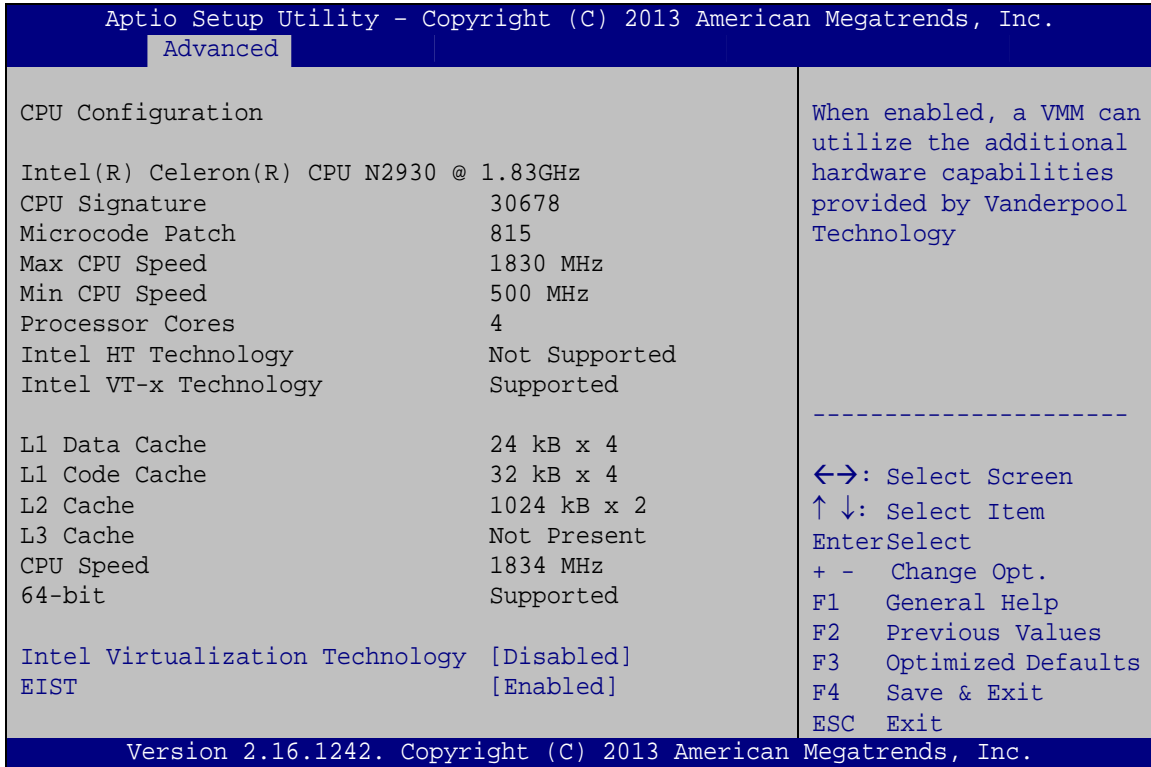

BIOS Menu 10: CPU Configuration

The CPU Configuration menu (**BIOS Menu 10**) lists the following CPU details:

- CPU Signature: Lists the CPU signature value.
- Microcode Patch: Lists the microcode patch being used.
- Max CPU Speed: Lists the maximum CPU processing speed.
- Min CPU Speed: Lists the minimum CPU processing speed.
- Processor Cores: Lists the number of the processor core
- Intel HT Technology: Indicates if Intel HT Technology is supported by the CPU.
- Intel VT-x Technology: Indicates if Intel VT-x Technology is supported by the CPU.
- L1 Data Cache: Lists the amount of data storage space on the L1 cache.
- L1 Code Cache: Lists the amount of code storage space on the L1 cache.
- L2 Cache: Lists the amount of storage space on the L2 cache.
- L3 Cache: Lists the amount of storage space on the L3 cache.

KINO-DBT Mini-ITX SBC

→ Intel Virtualization Technology [Disabled]

Use the **Intel Virtualization Technology** option to enable or disable virtualization on the system. When combined with third party software, Intel® Virtualization technology allows several OSs to run on the same system at the same time.

→ **Disabled** **DEFAULT** Disables Intel Virtualization Technology.

→ **Enabled** Enables Intel Virtualization Technology.

→ EIST [Enabled]

Use the **EIST** option to enable or disable Enhanced Intel SpeedStep® Techonology (EIST).

→ **Disabled** Disables Enhanced Intel SpeedStep® Techonology.

→ **Enabled** **DEFAULT** Enables Enhanced Intel SpeedStep® Techonology.

5.3.7 IDE Configuration

Use the **IDE Configuration** menu (**BIOS Menu 11**) to change and/or set the configuration of the SATA devices installed in the system.

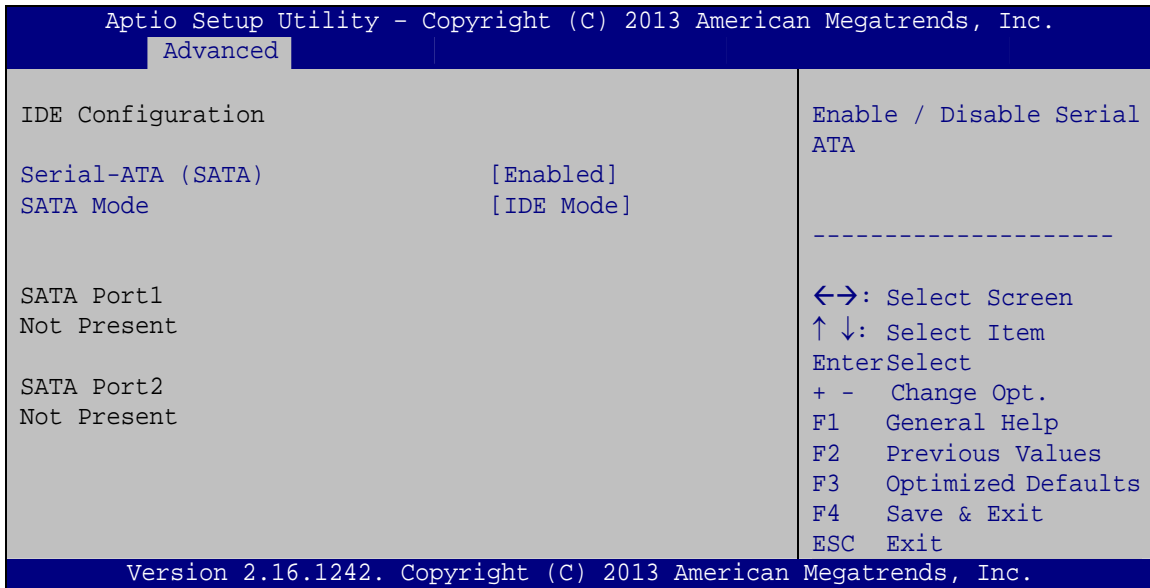

BIOS Menu 11: IDE Configuration

→ Serial-ATA (SATA) [Enabled]

Use the **Serial-ATA (SATA)** option to enable or disable the serial ATA.

- **Enabled** **DEFAULT** Enables the serial ATA.
- **Disabled** Disables the serial ATA.

→ SATA Mode [IDE Mode]

Use the **SATA Mode** option to configure SATA devices as normal IDE devices.

- **IDE Mode** **DEFAULT** Configures SATA devices as normal IDE device.
- **AHCI Mode** Configures SATA devices as AHCI device.

KINO-DBT Mini-ITX SBC

5.3.8 Trusted Computing

Use the **Trusted Computing** menu (**BIOS Menu 13**) to configure settings related to the Trusted Computing Group (TCG) Trusted Platform Module (TPM).

```

Aptio Setup Utility - Copyright (C) 2013 American Megatrends, Inc.
  Advanced
-----
Configuration
Security Device Support          [Disabled]
Current Status Information
No Security Device Found
-----
<=>: Select Screen
↑ ↓: Select Item
Enter>Select
+ -  Change Opt.
F1   General Help
F2   Previous Values
F3   Optimized Defaults
F4   Save & Exit
ESC  Exit
-----
Version 2.16.1242. Copyright (C) 2013 American Megatrends, Inc.
  
```

BIOS Menu 12: Trusted Computing

➔ Security Device Support [Disabled]

Use the **Security Device Support** option to configure support for the security device.

- ➔ **Disabled** **DEFAULT** Security device is disabled
- ➔ **Enabled** Security device is enabled

5.3.9 USB Configuration

Use the **USB Configuration** menu (**BIOS Menu 13**) to read USB configuration information and configure the USB settings.

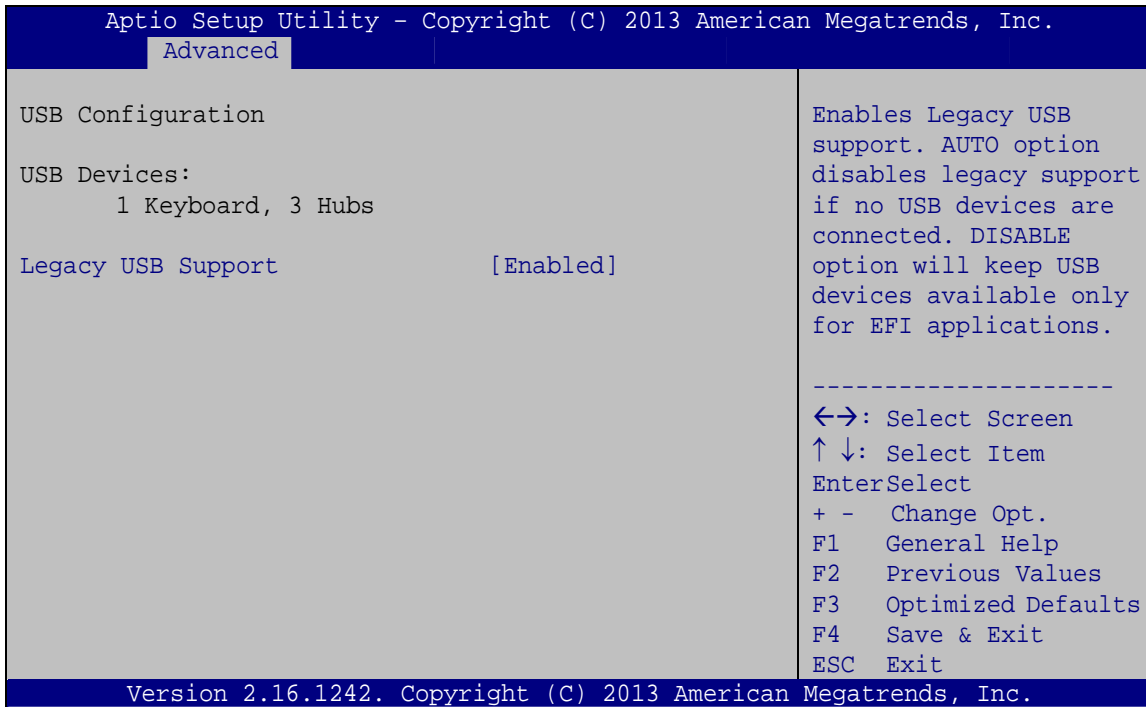

BIOS Menu 13: USB Configuration

➔ USB Devices

The **USB Devices Enabled** field lists the USB devices that are enabled on the system

➔ Legacy USB Support [Enabled]

Use the **Legacy USB Support** BIOS option to enable USB mouse and USB keyboard support. Normally if this option is not enabled, any attached USB mouse or USB keyboard does not become available until a USB compatible operating system is fully booted with all USB drivers loaded. When this option is enabled, any attached USB mouse or USB keyboard can control the system even when there is no USB driver loaded onto the system.

➔ **Enabled** **DEFAULT** Legacy USB support enabled

KINO-DBT Mini-ITX SBC

- ➔ **Disabled** Legacy USB support disabled
- ➔ **Auto** Legacy USB support disabled if no USB devices are connected

5.4 Chipset

Use the **Chipset** menu (**BIOS Menu 14**) to access the North Bridge and South Bridge subsystem configuration menus.



WARNING!

Setting the wrong values for the Chipset BIOS selections in the Chipset BIOS menu may cause the system to malfunction.

```

Aptio Setup Utility - Copyright (C) 2013 American Megatrends, Inc.
Main   Advanced  Chipset  Security  Boot   Save & Exit
-----
> North Bridge
> South Bridge

North Bridge Parameters.

-----
<=>: Select Screen
↑ ↓: Select Item
Enter Select
+ - Change Opt.
F1  General Help
F2  Previous Values
F3  Optimized Defaults
F4  Save & Exit
ESC Exit

Version 2.16.1242. Copyright (C) 2013 American Megatrends, Inc.
  
```

BIOS Menu 14: Chipset

5.4.1 North Bridge

Use the **North Bridge** menu (**BIOS Menu 15**) to configure the north bridge parameters.

```

Aptio Setup Utility - Copyright (C) 2013 American Megatrends, Inc.
  Chipset
  > Intel IGD Configuration
Memory Information
Total Memory           4096 MB (LPDDR3)
Memory Slot0           4096 MB (LPDDR3)
Memory Slot2           Not Present

Intel IGD Configuration
-----
<->: Select Screen
↑ ↓: Select Item
EnterSelect
+ -  Change Opt.
F1   General Help
F2   Previous Values
F3   Optimized Defaults
F4   Save & Exit
ESC  Exit

Version 2.16.1242. Copyright (C) 2013 American Megatrends, Inc.
  
```

BIOS Menu 15: North Bridge

5.4.1.1 Intel IGD Configuration

Use the **Intel IGD Configuration** submenu (**BIOS Menu 16**) to configure the graphics settings.

```

Aptio Setup Utility - Copyright (C) 2013 American Megatrends, Inc.
  Chipset
  Intel IGD Configuration
Primary Display           [Auto]
DVMT Pre-Allocated       [256M]
DVMT Total Gfx Mem       [Max]

Primary IGFX Boot Display [VBIOS Default]

Select which of IGD/PCI
Graphics device should
be Primary Display.
-----
<->: Select Screen
↑ ↓: Select Item
EnterSelect
+ -  Change Opt.
F1   General Help
F2   Previous Values
F3   Optimized Defaults
F4   Save & Exit
ESC  Exit

Version 2.16.1242. Copyright (C) 2013 American Megatrends, Inc.
  
```

BIOS Menu 16: Intel IGD Configuration

KINO-DBT Mini-ITX SBC

→ Primary Display [Auto]

Use the **Primary Display** option to select which IGD/PCI graphics device will be the primary display or to select SG for switchable Gfx. Configuration options are listed below.

- Auto **DEFAULT**
- IGD
- PCI

→ DVMT Pre-Allocated [256M]

Use the **DVMT Pre-Allocated** option to specify the amount of system memory that can be used by the internal graphics device.

- 64M 64 MB of memory used by internal graphics device
- 128M 128 MB of memory used by internal graphics device
- 256M **DEFAULT** 256 MB of memory used by internal graphics device
- 512M 512 MB of memory used by internal graphics device

→ DVMT Total Gfx Mem [Max]

Use the **DVMT Total Gfx Mem** option to specify the maximum amount of memory that can be allocated as graphics memory. Configuration options are listed below.

- 128MB
- 256MB
- Max **Default**

→ Primary IGFX Boot Display [VBIOS Default]

Use the **Primary IGFX Boot Display** option to select the display device used by the system when it boots. Configuration options are listed below.

- VBIOS Default **DEFAULT**
- CRT

- Display Port
- DVI

5.4.2 South Bridge

Use the **South Bridge** menu (**BIOS Menu 17**) to configure the south bridge parameters.

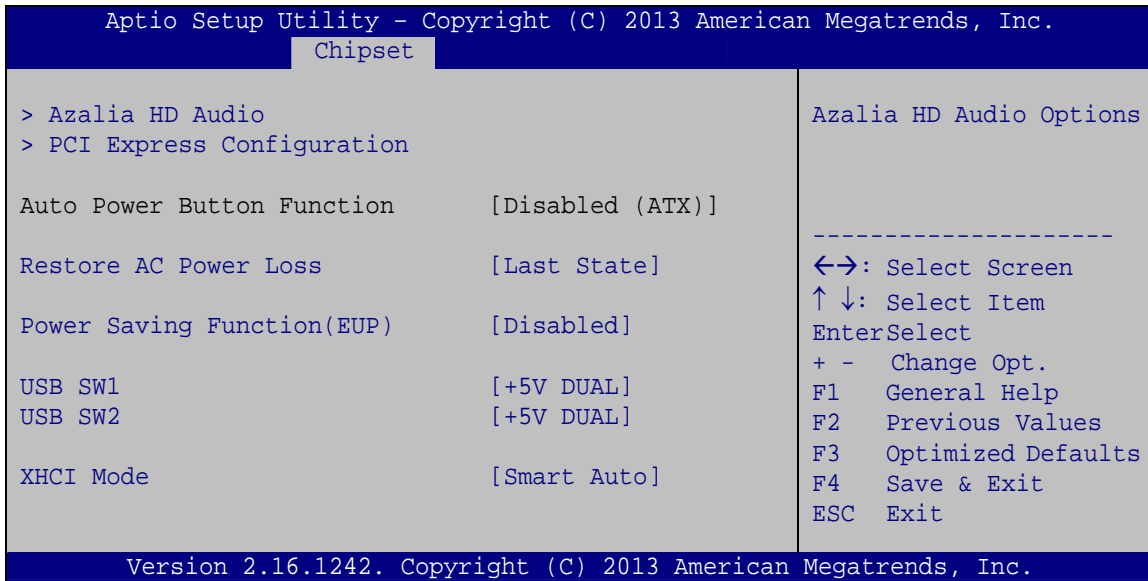

BIOS Menu 17: South Bridge

➔ Restore on AC Power Loss [Last State]

Use the **Restore on AC Power Loss** BIOS option to specify what state the system returns to if there is a sudden loss of power to the system.

- ➔ **Power Off** The system remains turned off
- ➔ **Power On** The system turns on
- ➔ **Last State DEFAULT** The system returns to its previous state. If it was on, it turns itself on. If it was off, it remains off.

➔ Power Saving Function [Disabled]

Use the **Power Saving Function** BIOS option to enable or reduce power consumption in the S5 state. When enabled, the system can only be powered-up using the power button.

KINO-DBT Mini-ITX SBC

- ➔ **Enabled** Power Saving Function support enabled
- ➔ **Disabled** **DEFAULT** Power Saving Function support disabled

➔ **USB SW1 [+5V DUAL]**

Use the **USB SW1** BIOS option to configure the USB power source for the corresponding USB connector (**Table 5-2**).

- ➔ **+5V** Set the USB power source to +5V
- ➔ **+5V DUAL** **DEFAULT** Set the USB power source to +5V dual

➔ **USB SW2 [+5V DUAL]**

Use the **USB SW2** BIOS option to configure the USB power source for the corresponding USB connector (**Table 5-2**).

- ➔ **+5V** Set the USB power source to +5V
- ➔ **+5V DUAL** **DEFAULT** Set the USB power source to +5V dual

BIOS Options	Configured USB Ports
USB SW1	LAN1_USB1 (external USB 3.0 ports) LAN2_USB2 (external USB 2.0 ports)
USB SW2	USB1, USB2 (internal USB 2.0 ports)

Table 5-2: BIOS Options and Configured USB Ports

➔ **XHCI Mode [Smart Auto]**

Use the **XHCI Mode** BIOS option to configure the USB xHCI (USB 3.0) controller.

- ➔ **Enabled** Enable the xHCI controller. USB 3.0 ports behave as USB 3.0 ports.
- ➔ **Smart** **DEFAULT** Allow the use of USB 3.0 devices prior to OS boot.
Auto USB 3.0 ports function as USB 3.0 ports even during a reboot.

5.4.2.1 Azalia HD Audio

Use the **Azalia HD Audio** submenu (**BIOS Menu 18**) to configure the High Definition Audio codec.

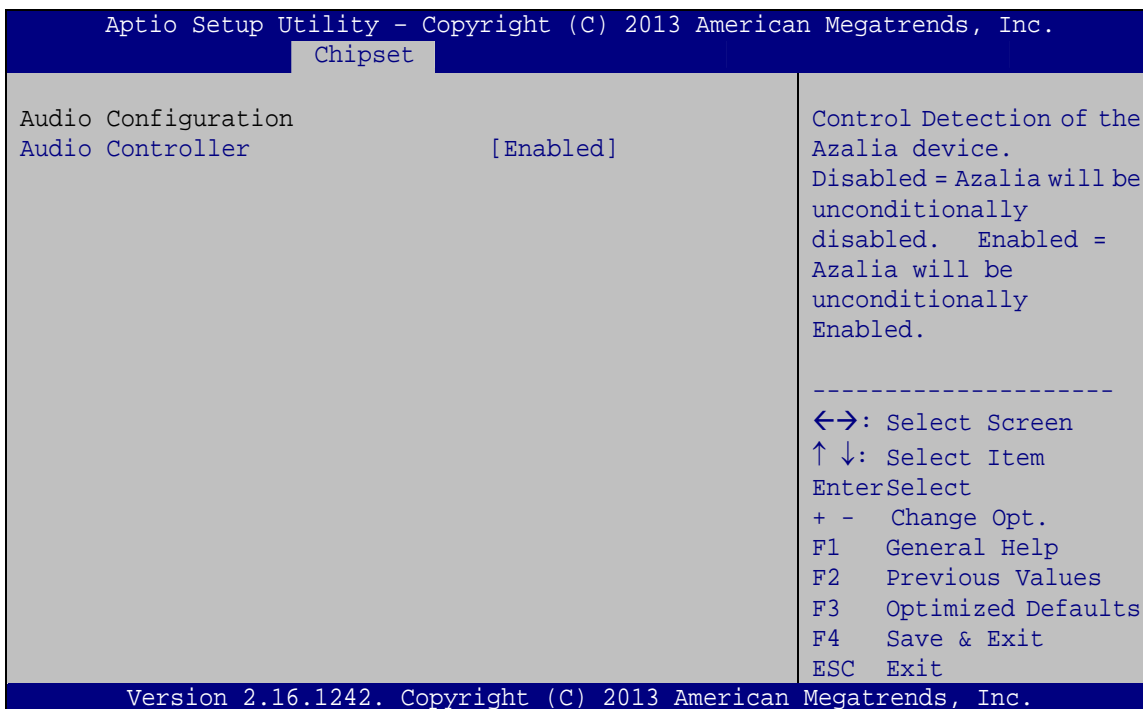

BIOS Menu 18: Azalia HD Audio

→ Audio Controller [Enabled]

Use the **Audio Controller** BIOS option to enable or disable the High Definition Audio controller.

- **Disabled** The High Definition Audio controller is disabled.
- **Enabled** **DEFAULT** The High Definition Audio controller is enabled.

KINO-DBT Mini-ITX SBC

5.4.2.2 PCI Express Configuration

Use the **PCI Express Configuration** submenu (**BIOS Menu 19**) to configure the PCI Express slots.

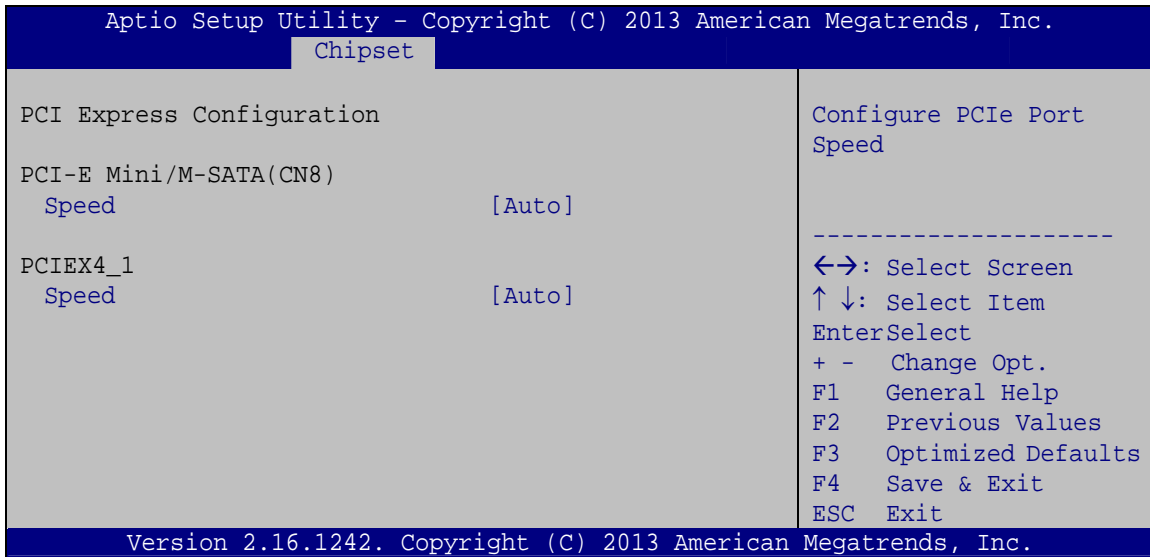

BIOS Menu 19: PCI Express Configuration

→ Speed [Auto]

Use the **Speed** option to configure the speed of the corresponding PCIe slot.

- Auto **DEFAULT**
- Gen 2
- Gen 1

5.5 Security

Use the **Security** menu (**BIOS Menu 20**) to set system and user passwords.

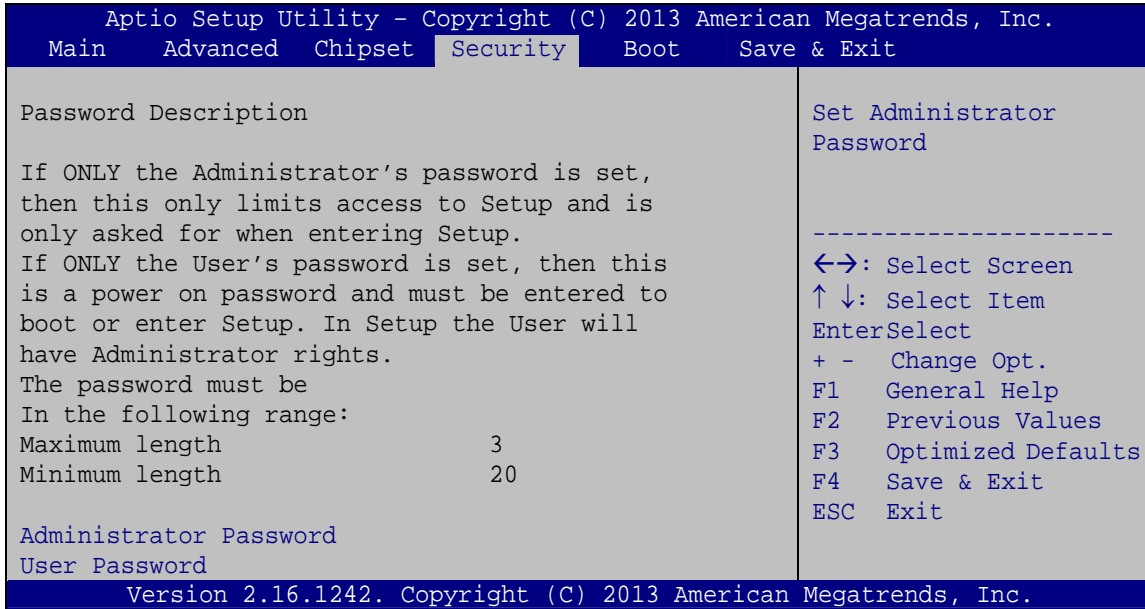

BIOS Menu 20: Security

➔ Administrator Password

Use the **Administrator Password** to set or change a administrator password.

➔ User Password

Use the **User Password** to set or change a user password.

KINO-DBT Mini-ITX SBC

5.6 Boot

Use the **Boot** menu (**BIOS Menu 21**) to configure system boot options.

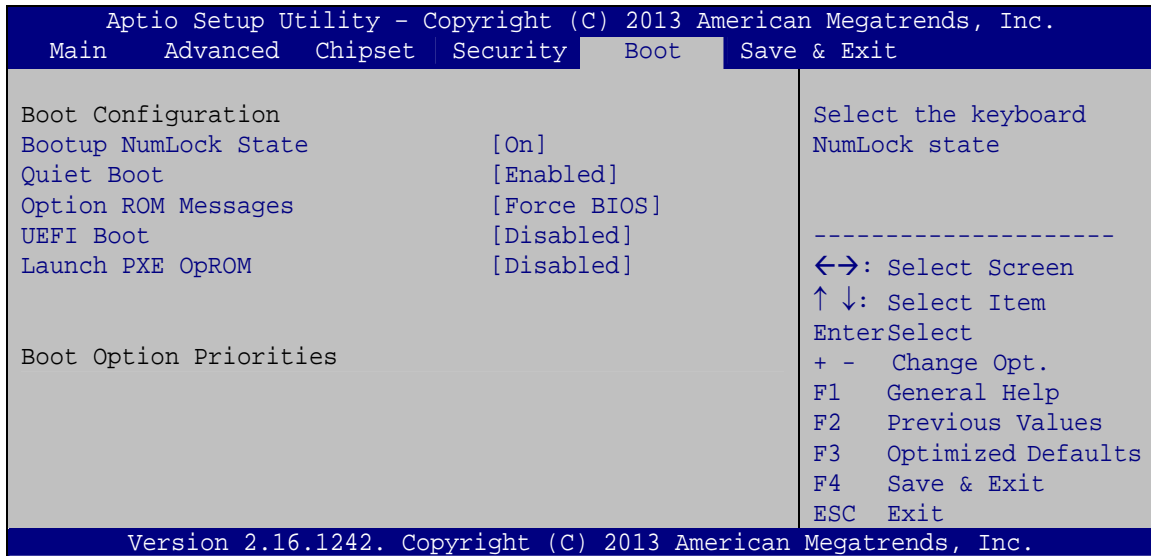

BIOS Menu 21: Boot

→ Bootup NumLock State [On]

Use the **Bootup NumLock State** BIOS option to specify if the number lock setting must be modified during boot up.

- **On** **DEFAULT** Allows the Number Lock on the keyboard to be enabled automatically when the computer system boots up. This allows the immediate use of the 10-key numeric keypad located on the right side of the keyboard. To confirm this, the Number Lock LED light on the keyboard is lit.
- **Off** Does not enable the keyboard Number Lock automatically. To use the 10-keys on the keyboard, press the Number Lock key located on the upper left-hand corner of the 10-key pad. The Number Lock LED on the keyboard lights up when the Number Lock is engaged.

→ Quiet Boot [Enabled]

Use the **Quiet Boot** BIOS option to select the screen display when the system boots.

- **Disabled** Normal POST messages displayed
- **Enabled** **DEFAULT** OEM Logo displayed instead of POST messages

→ Option ROM Messages [Force BIOS]

Use the **Option ROM Messages** option to set the Option ROM display mode.

- **Force BIOS** **DEFAULT** Sets display mode to force BIOS.
- **Keep Current** Sets display mode to current.

→ UEFI Boot [Disabled]

Use the **UEFI Boot** option to enable or disable to boot from a UEFI device.

- **Enabled** Enable to boot from a UEFI device.
- **Disabled** **DEFAULT** Disable to boot from a UEFI device.

→ Launch PXE OpROM [Disabled]

Use the **Launch PXE OpROM** option to enable or disable boot option for legacy network devices.

- **Disabled** **DEFAULT** Ignore all PXE Option ROMs
- **Enabled** Load PXE Option ROMs

KINO-DBT Mini-ITX SBC

5.7 Exit

Use the **Exit** menu (**BIOS Menu 22**) to load default BIOS values, optimal failsafe values and to save configuration changes.

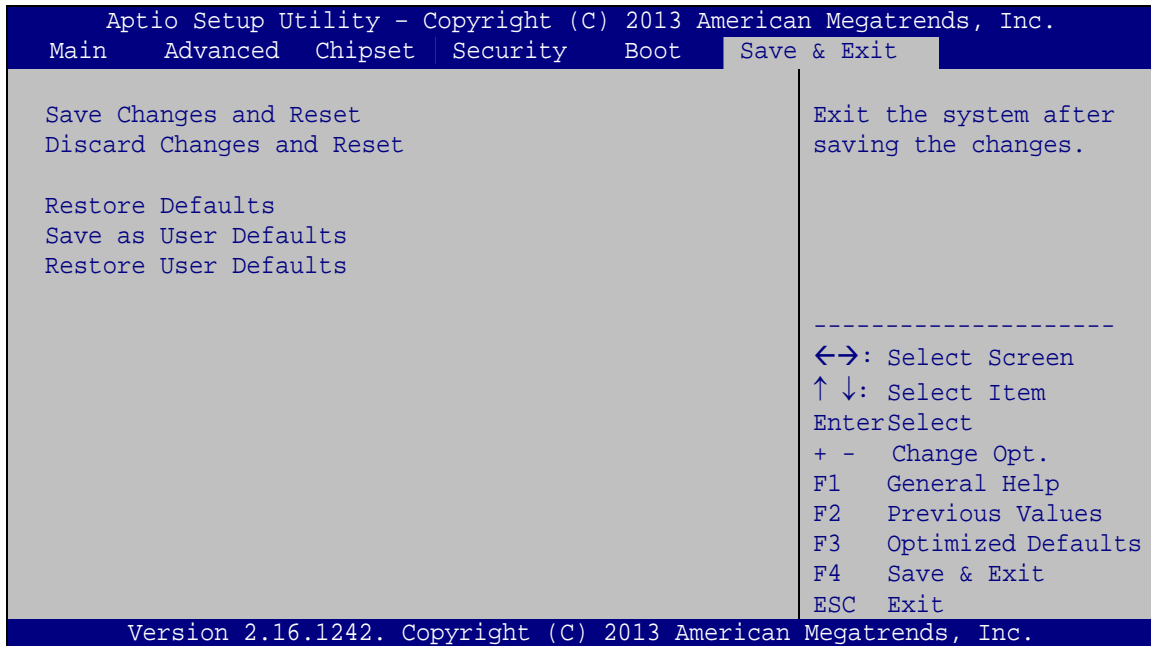
**BIOS Menu 22:Exit**→ **Save Changes and Reset**

Use the **Save Changes and Reset** option to save the changes made to the BIOS options and reset the system.

→ **Discard Changes and Reset**

Use the **Discard Changes and Reset** option to exit the system without saving the changes made to the BIOS configuration setup program.

→ **Restore Defaults**

Use the **Restore Defaults** option to load the optimal default values for each of the parameters on the Setup menus. **F3 key can be used for this operation.**

→ **Save as User Defaults**

Use the **Save as User Defaults** option to save the changes done so far as user defaults.

→ **Restore User Defaults**

Use the **Restore User Defaults** option to restore the user defaults to all the setup options.

Chapter

6

Software Drivers

6.1 Available Software Drivers



NOTE:

The content of the CD may vary throughout the life cycle of the product and is subject to change without prior notice. Visit the IEI website or contact technical support for the latest updates.

All the drivers for the KINO-DBT series are on the utility CD that came with the system. The utility CD contains drivers for Windows 7 and Windows 8 operating systems. Please select the corresponding drivers for the system.

The following drivers can be installed on the **Windows 7** operating system:

- Chipset
- Graphics (Intel® EMGD)
- I/O driver
- TXE
- USB 3.0
- LAN (Realtek)
- Audio

The following drivers can be installed on the **Windows 8** operating system:

- Chipset
- Graphics
- I/O driver
- TXE
- LAN (Realtek)
- Audio

6.2 Software Installation

All the drivers for the KINO-DBT are on the CD that came with the system. To install the drivers, please follow the steps below.

KINO-DBT Mini-ITX SBC

Step 1: Insert the CD into a CD drive connected to the system.



NOTE:

If the installation program doesn't start automatically:
Click "Start->My Computer->CD Drive->autorun.exe"

Step 2: The driver main menu appears.

Step 3: Click **KINO-DBT**.

Step 4: A new screen with a list of available drivers appears (**Figure 6-1**).



Figure 6-1: Available Drivers

Step 5: Install all of the necessary drivers in the menu.

Appendix

A

Regulatory Compliance

DECLARATION OF CONFORMITY



This equipment has been tested and found to comply with specifications for CE marking. If the user modifies and/or installs other devices in the equipment, the CE conformity declaration may no longer apply.

FCC WARNING



This equipment complies with Part 15 of the FCC Rules. Operation is subject to the following two conditions:

- This device may not cause harmful interference, and
- This device must accept any interference received, including interference that may cause undesired operation.

This equipment has been tested and found to comply with the limits for a Class A digital device, pursuant to part 15 of the FCC Rules. These limits are designed to provide reasonable protection against harmful interference when the equipment is operated in a commercial environment. This equipment generates, uses, and can radiate radio frequency energy and, if not installed and used in accordance with the instruction manual, may cause harmful interference to radio communications. Operation of this equipment in a residential area is likely to cause harmful interference in which case the user will be required to correct the interference at his own expense.

Appendix

B

Product Disposal

**CAUTION:**

Risk of explosion if battery is replaced by an incorrect type. Only certified engineers should replace the on-board battery.

Dispose of used batteries according to instructions and local regulations.

- Outside the European Union – If you wish to dispose of used electrical and electronic products outside the European Union, please contact your local authority so as to comply with the correct disposal method.
- Within the European Union – The device that produces less waste and is easier to recycle is classified as electronic device in terms of the European Directive 2012/19/EU (WEEE), and must not be disposed of as domestic garbage.

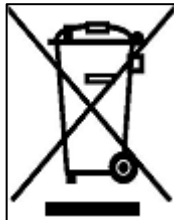

EU-wide legislation, as implemented in each Member State, requires that waste electrical and electronic products carrying the mark (left) must be disposed of separately from normal household waste. This includes monitors and electrical accessories, such as signal cables or power cords. When you need to dispose of your device, please follow the guidance of your local authority, or ask the shop where you purchased the product. The mark on electrical and electronic products only applies to the current European Union Member States.

Please follow the national guidelines for electrical and electronic product disposal.

Appendix

C

BIOS Options

KINO-DBT Mini-ITX SBC

Below is a list of BIOS configuration options in the BIOS chapter.

BIOS Information	66
Memory Information	67
TXE Information	67
System Date [xx/xx/xx]	67
System Time [xx:xx:xx]	67
ACPI Sleep State [S3 (Suspend to RAM)]	69
Serial Port [Enabled]	71
Change Settings [Auto]	71
Serial Port [Enabled]	72
Change Settings [Auto]	72
Serial Port [Enabled]	73
Change Settings [Auto]	73
Serial Port [Enabled]	74
Change Settings [Auto]	74
Serial Port [Enabled]	75
Change Settings [Auto]	76
Serial Port [Enabled]	77
Change Settings [Auto]	77
PC Health Status	79
CPU_FAN1 Smart Fan Control [Auto Mode]	80
SYS_FAN1 Smart Fan Control [Auto Mode]	80
Auto mode fan start temperature	81
Auto mode fan off temperature	81
Auto mode fan start PWM	81
Auto mode fan start slope PWM	81
Wake System with Fixed Time [Disabled]	82
Console Redirection [Disabled]	84
Terminal Type [ANSI]	84
Bits per second [115200]	84
Data Bits [8]	84
Parity [None]	85
Stop Bits [1]	85
Intel Virtualization Technology [Disabled]	87

EIST [Enabled].....	87
Serial-ATA (SATA) [Enabled].....	88
SATA Mode [IDE Mode].....	88
Security Device Support [Disabled].....	89
USB Devices.....	90
Legacy USB Support [Enabled].....	90
Primary Display [Auto].....	93
DVMT Pre-Allocated [256M].....	93
DVMT Total Gfx Mem [Max].....	93
Primary IGFX Boot Display [VBIOS Default].....	93
Restore on AC Power Loss [Last State].....	94
Power Saving Function [Disabled].....	94
USB SW1 [+5V DUAL].....	95
USB SW2 [+5V DUAL].....	95
XHCI Mode [Smart Auto].....	95
Audio Controller [Enabled].....	96
Speed [Auto].....	97
Administrator Password.....	98
User Password.....	98
Bootup NumLock State [On].....	99
Quiet Boot [Enabled].....	100
Option ROM Messages [Force BIOS].....	100
UEFI Boot [Disabled].....	100
Launch PXE OpROM [Disabled].....	100
Save Changes and Reset.....	101
Discard Changes and Reset.....	101
Restore Defaults.....	101
Save as User Defaults.....	102
Restore User Defaults.....	102

Appendix

D

Terminology

AC '97	Audio Codec 97 (AC'97) refers to a codec standard developed by Intel® in 1997.
ACPI	Advanced Configuration and Power Interface (ACPI) is an OS-directed configuration, power management, and thermal management interface.
AHCI	Advanced Host Controller Interface (AHCI) is a SATA Host controller register-level interface.
ATA	The Advanced Technology Attachment (ATA) interface connects storage devices including hard disks and CD-ROM drives to a computer.
ARMD	An ATAPI Removable Media Device (ARMD) is any ATAPI device that supports removable media, besides CD and DVD drives.
ASKIR	Amplitude Shift Keyed Infrared (ASKIR) is a form of modulation that represents a digital signal by varying the amplitude (“volume”) of the signal. A low amplitude signal represents a binary 0, while a high amplitude signal represents a binary 1.
BIOS	The Basic Input/Output System (BIOS) is firmware that is first run when the computer is turned on and can be configured by the end user
CODEC	The Compressor-Decompressor (CODEC) encodes and decodes digital audio data on the system.
CMOS	Complimentary metal-oxide-conductor is an integrated circuit used in chips like static RAM and microprocessors.
COM	COM refers to serial ports. Serial ports offer serial communication to expansion devices. The serial port on a personal computer is usually a male D-sub 9 connector.
DAC	The Digital-to-Analog Converter (DAC) converts digital signals to analog signals.

KINO-DBT Mini-ITX SBC

DDR	Double Data Rate refers to a data bus transferring data on both the rising and falling edges of the clock signal.
DMA	Direct Memory Access (DMA) enables some peripheral devices to bypass the system processor and communicate directly with the system memory.
DIMM	Dual Inline Memory Modules are a type of RAM that offer a 64-bit data bus and have separate electrical contacts on each side of the module.
DIO	The digital inputs and digital outputs are general control signals that control the on/off circuit of external devices or TTL devices. Data can be read or written to the selected address to enable the DIO functions.
EHCI	The Enhanced Host Controller Interface (EHCI) specification is a register-level interface description for USB 2.0 Host Controllers.
EIDE	Enhanced IDE (EIDE) is a newer IDE interface standard that has data transfer rates between 4.0 MBps and 16.6 MBps.
EIST	Enhanced Intel® SpeedStep Technology (EIST) allows users to modify the power consumption levels and processor performance through application software. The application software changes the bus-to-core frequency ratio and the processor core voltage.
FSB	The Front Side Bus (FSB) is the bi-directional communication channel between the processor and the Northbridge chipset.
GbE	Gigabit Ethernet (GbE) is an Ethernet version that transfers data at 1.0 Gbps and complies with the IEEE 802.3-2005 standard.
GPIO	General purpose input
HDD	Hard disk drive (HDD) is a type of magnetic, non-volatile computer storage device that stores digitally encoded data.
ICH	The Input/Output Control Hub (ICH) is an Intel® Southbridge chipset.

IrDA	Infrared Data Association (IrDA) specify infrared data transmission protocols used to enable electronic devices to wirelessly communicate with each other.
L1 Cache	The Level 1 Cache (L1 Cache) is a small memory cache built into the system processor.
L2 Cache	The Level 2 Cache (L2 Cache) is an external processor memory cache.
LCD	Liquid crystal display (LCD) is a flat, low-power display device that consists of two polarizing plates with a liquid crystal panel in between.
LVDS	Low-voltage differential signaling (LVDS) is a dual-wire, high-speed differential electrical signaling system commonly used to connect LCD displays to a computer.
POST	The Power-on Self Test (POST) is the pre-boot actions the system performs when the system is turned-on.
RAM	Random Access Memory (RAM) is volatile memory that loses data when power is lost. RAM has very fast data transfer rates compared to other storage like hard drives.
SATA	Serial ATA (SATA) is a serial communications bus designed for data transfers between storage devices and the computer chipsets. The SATA bus has transfer speeds up to 1.5 Gbps and the SATA II bus has data transfer speeds of up to 3.0 Gbps.
S.M.A.R.T	Self Monitoring Analysis and Reporting Technology (S.M.A.R.T) refers to automatic status checking technology implemented on hard disk drives.
UART	Universal Asynchronous Receiver-transmitter (UART) is responsible for asynchronous communications on the system and manages the system's serial communication (COM) ports.
UHCI	The Universal Host Controller Interface (UHCI) specification is a register-level interface description for USB 1.1 Host Controllers.

KINO-DBT Mini-ITX SBC

USB

The Universal Serial Bus (USB) is an external bus standard for interfacing devices. USB 1.1 supports 12Mbps data transfer rates and USB 2.0 supports 480Mbps data transfer rates.

VGA

The Video Graphics Array (VGA) is a graphics display system developed by IBM.

Appendix

E

Digital I/O Interface

KINO-DBT Mini-ITX SBC

The DIO connector on the KINO-DBT is interfaced to GPIO ports on the Super I/O chipset. The DIO has both 8-bit digital inputs and 8-bit digital outputs. The digital inputs and digital outputs are generally control signals that control the on/off circuit of external devices or TTL devices. Data can be read or written to the selected address to enable the DIO functions.

**NOTE:**

For further information, please refer to the datasheet for the Super I/O chipset.

The BIOS interrupt call **INT 15H** controls the digital I/O.

INT 15H:

AH – 6FH	
<u>Sub-function:</u>	
AL – 8	: Set the digital port as INPUT
AL	: Digital I/O input value

Assembly Language Sample 1

```
MOV    AX, 6F08H    ; setting the digital port as input
INT    15H          ;
```

AL low byte = value

AH – 6FH	
<u>Sub-function:</u>	
AL – 9	: Set the digital port as OUTPUT
BL	: Digital I/O output value

Assembly Language Sample 2

```
MOV AX, 6F09H ; setting the digital port as output  
MOV BL, 09H ; digital value is 09H  
INT 15H ;
```

Digital Output is 1001b

Appendix

F

Watchdog Timer



NOTE:

The following discussion applies to DOS environment. Contact IEI support or visit the IEI website for specific drivers for other operating systems.

The Watchdog Timer is provided to ensure that standalone systems can always recover from catastrophic conditions that cause the CPU to crash. This condition may have occurred by external EMIs or a software bug. When the CPU stops working correctly, Watchdog Timer either performs a hardware reset (cold boot) or a Non-Maskable Interrupt (NMI) to bring the system back to a known state.

A BIOS function call (INT 15H) is used to control the Watchdog Timer.

INT 15H:

AH – 6FH Sub-function:	
AL – 2:	Sets the Watchdog Timer's period.
BL:	Time-out value (Its unit-second is dependent on the item "Watchdog Timer unit select" in CMOS setup).

Table F-1: AH-6FH Sub-function

Call sub-function 2 to set the time-out period of Watchdog Timer first. If the time-out value is not zero, the Watchdog Timer starts counting down. When the timer value reaches zero, the system resets. To ensure that this reset condition does not occur, calling sub-function 2 must periodically refresh the Watchdog Timer. However, the watchdog timer is disabled if the time-out value is set to zero.

A tolerance of at least 10% must be maintained to avoid unknown routines within the operating system (DOS), such as disk I/O that can be very time-consuming.

KINO-DBT Mini-ITX SBC

**NOTE:**

When exiting a program it is necessary to disable the Watchdog Timer, otherwise the system resets.

EXAMPLE PROGRAM:

; INITIAL TIMER PERIOD COUNTER

;

W_LOOP:

;

```

MOV      AX, 6F02H      ;setting the time-out value
MOV      BL, 30         ;time-out value is 48 seconds
INT      15H

```

;

; ADD THE APPLICATION PROGRAM HERE

;

```

CMP      EXIT_AP, 1     ;is the application over?
JNE      W_LOOP        ;No, restart the application

MOV      AX, 6F02H     ;disable Watchdog Timer
MOV      BL, 0         ;
INT      15H

```

;

; EXIT ;

Appendix

G

Hazardous Materials Disclosure

KINO-DBT Mini-ITX SBC

The details provided in this appendix are to ensure that the product is compliant with the Peoples Republic of China (China) RoHS standards. The table below acknowledges the presences of small quantities of certain materials in the product, and is applicable to China RoHS only.

A label will be placed on each product to indicate the estimated “Environmentally Friendly Use Period” (EFUP). This is an estimate of the number of years that these substances would “not leak out or undergo abrupt change.” This product may contain replaceable sub-assemblies/components which have a shorter EFUP such as batteries and lamps. These components will be separately marked.

Please refer to the following table.

Part Name	Toxic or Hazardous Substances and Elements					
	Lead (Pb)	Mercury (Hg)	Cadmium (Cd)	Hexavalent Chromium (CR(VI))	Polybrominated Biphenyls (PBB)	Polybrominated Diphenyl Ethers (PBDE)
Housing	O	O	O	O	O	O
Display	O	O	O	O	O	O
Printed Circuit Board	O	O	O	O	O	O
Metal Fasteners	O	O	O	O	O	O
Cable Assembly	O	O	O	O	O	O
Fan Assembly	O	O	O	O	O	O
Power Supply Assemblies	O	O	O	O	O	O
Battery	O	O	O	O	O	O

O: This toxic or hazardous substance is contained in all of the homogeneous materials for the part is below the limit requirement in SJ/T11363-2006 (now replaced by GB/T 26572-2011).

X: This toxic or hazardous substance is contained in at least one of the homogeneous materials for this part is above the limit requirement in SJ/T11363-2006 (now replaced by GB/T 26572-2011).

此附件旨在确保本产品符合中国 RoHS 标准。以下表格标示此产品中某有毒物质的含量符合中国 RoHS 标准规定的限量要求。

本产品上会附有“环境友好使用期限”的标签，此期限是估算这些物质“不会有泄漏或突变”的年限。本产品可能包含有较短的环境友好使用期限的可替换元件，像是电池或灯管，这些元件将会单独标示出来。

部件名称	有毒有害物质或元素					
	铅 (Pb)	汞 (Hg)	镉 (Cd)	六价铬 (CR(VI))	多溴联苯 (PBB)	多溴二苯 醚 (PBDE)
壳体	○	○	○	○	○	○
显示	○	○	○	○	○	○
印刷电路板	○	○	○	○	○	○
金属螺帽	○	○	○	○	○	○
电缆组装	○	○	○	○	○	○
风扇组装	○	○	○	○	○	○
电力供应组装	○	○	○	○	○	○
电池	○	○	○	○	○	○

○: 表示该有毒有害物质在该部件所有物质材料中的含量均在 SJ/T 11363-2006 (现由 GB/T 26572-2011 取代) 标准规定的限量要求以下。

X: 表示该有毒有害物质至少在该部件的某一均质材料中的含量超出 SJ/T 11363-2006 (现由 GB/T 26572-2011 取代) 标准规定的限量要求。