



MODEL:  
**ECN-360A-ULT3**

High Performance Fanless Embedded System with Intel® Core™ i5-6300U/  
Celeron® 3855U processor, Dual HDMI, RS-232/422/485,  
USB 3.0, RoHS Compliant

# User Manual

# Revision

---

Date	Version	Changes
21 June, 2018	1.01	Updated operating temperature from -20°C ~ 60°C to -20°C ~ 50°C
6 November, 2017	1.00	Initial release

# Copyright

---

## COPYRIGHT NOTICE

The information in this document is subject to change without prior notice in order to improve reliability, design and function and does not represent a commitment on the part of the manufacturer.

In no event will the manufacturer be liable for direct, indirect, special, incidental, or consequential damages arising out of the use or inability to use the product or documentation, even if advised of the possibility of such damages.

This document contains proprietary information protected by copyright. All rights are reserved. No part of this manual may be reproduced by any mechanical, electronic, or other means in any form without prior written permission of the manufacturer.

## TRADE MARKS

All registered trademarks and product names mentioned herein are used for identification purposes only and may be trademarks and/or registered trademarks of their respective owners.

# Manual Conventions

---



## WARNING

Warnings appear where overlooked details may cause damage to the equipment or result in personal injury. Warnings should be taken seriously.



## CAUTION

Cautionary messages should be heeded to help reduce the chance of losing data or damaging the product.



## NOTE

These messages inform the reader of essential but non-critical information. These messages should be read carefully as any directions or instructions contained therein can help avoid making mistakes.



## HOT SURFACE

This symbol indicates a hot surface that should not be touched without taking care.

# Table of Contents

<b>1 INTRODUCTION</b> .....	<b>1</b>
1.1 OVERVIEW.....	2
1.2 MODEL VARIATIONS.....	2
1.3 FEATURES.....	3
1.4 TECHNICAL SPECIFICATIONS.....	3
1.5 FRONT PANEL.....	5
1.6 REAR PANEL.....	5
1.7 DIMENSIONS.....	7
<b>2 UNPACKING</b> .....	<b>8</b>
2.1 ANTI-STATIC PRECAUTIONS.....	9
2.2 UNPACKING PRECAUTIONS.....	9
2.3 UNPACKING CHECKLIST.....	10
<b>3 INSTALLATION</b> .....	<b>12</b>
3.1 INSTALLATION PRECAUTIONS.....	13
3.2 HARD DISK DRIVE (HDD) INSTALLATION.....	13
3.3 SO-DIMM INSTALLATION.....	15
3.4 MOUNTING THE SYSTEM WITH MOUNTING BRACKETS.....	17
3.5 POWERING ON/OFF THE SYSTEM.....	18
<b>4 SYSTEM MOTHERBOARD</b> .....	<b>19</b>
4.1 PERIPHERAL INTERFACE CONNECTORS.....	20
4.1.1 Layout.....	20
4.1.2 Peripheral Interface Connectors.....	20
4.1.3 External Interface Panel Connectors.....	22
4.2 INTERNAL PERIPHERAL CONNECTORS.....	23
4.2.1 +12V DC-IN Power Connector.....	23
4.2.2 Audio Connector.....	23
4.2.3 Battery Connector.....	25
4.2.4 Buzzer Connector.....	26



4.2.5 Digital I/O Connector .....	27
4.2.6 Fan Connectors.....	28
4.2.7 Front Panel Connector .....	29
4.2.8 Internal DisplayPort Connector .....	30
4.2.9 Keyboard and Mouse Connector .....	31
4.2.10 LVDS Backlight Inverter Connector .....	32
4.2.11 LVDS LCD Connector.....	33
4.2.12 LAN LED Connectors .....	34
4.2.13 PCIe Mini Card Slot, Full-size .....	35
4.2.14 PCIe Mini Card Slot, Half-size.....	37
4.2.15 Power Button .....	38
4.2.16 Power Button Connector.....	39
4.2.17 Reset Button Connector .....	40
4.2.18 RS-232 Serial Port Connectors.....	41
4.2.19 RS-232/422/485 Serial Port Connector .....	42
4.2.20 SATA 6Gb/s Drive Connectors.....	43
4.2.21 SATA Power Connectors .....	44
4.2.22 SMBus Connector .....	45
4.2.23 SIM Card Slot.....	46
4.2.24 SPI Flash Connector, BIOS.....	47
4.2.25 SPI Flash Connector, EC.....	48
4.2.26 USB Connector .....	49
4.2.27 USB Connector, Type A .....	50
4.3 EXTERNAL PERIPHERAL INTERFACE CONNECTOR PANEL .....	51
4.3.1 HDMI Connectors.....	51
4.3.2 LAN Connectors.....	52
4.3.3 USB Connectors.....	53
4.4 SYSTEM CONFIGURATION.....	54
4.4.1 AT/ATX Mode Select Switch.....	54
4.4.2 Clear CMOS Button.....	54
4.4.3 Flash Descriptor Security Override Jumper.....	55
4.4.4 HDMI/DP Select Switch.....	56
4.4.5 LVDS Panel Resolution Select Switch .....	57
4.4.6 LVDS Voltage Select Jumper.....	59
4.5 DRIVER DOWNLOAD .....	60

<b>5 BIOS</b> .....	<b>62</b>
5.1 INTRODUCTION .....	63
5.1.1 Starting Setup .....	63
5.1.2 Using Setup .....	63
5.1.3 Getting Help .....	64
5.1.4 Unable to Reboot after Configuration Changes .....	64
5.1.5 BIOS Menu Bar .....	64
5.2 MAIN .....	65
5.3 ADVANCED .....	66
5.3.1 ACPI Settings .....	67
5.3.2 AMT Configuration .....	68
5.3.3 F81866 Super IO Configuration .....	69
5.3.3.1 Serial Port n Configuration .....	70
5.3.4 iWDD H/W Monitor .....	73
5.3.4.1 Smart Fan Mode Configuration .....	74
5.3.5 RTC Wake Settings .....	77
5.3.6 Serial Port Console Redirection .....	78
5.3.6.1 Legacy Console Redirection Settings .....	79
5.3.6.2 Console Redirection Settings .....	80
5.3.7 CPU Configuration .....	82
5.3.8 SATA Configuration .....	84
5.3.9 USB Configuration .....	86
5.3.10 IEI Feature .....	87
5.4 CHIPSET .....	88
5.4.1 System Agent (SA) Configuration .....	88
5.4.1.1 Graphics Configuration .....	89
5.4.1.2 Memory Configuration .....	93
5.4.2 PCH-IO Configuration .....	93
5.4.2.1 PCI Express Configuration .....	94
5.4.2.2 HD Audio Configuration .....	96
5.5 SECURITY .....	97
5.6 BOOT .....	98
5.7 EXIT .....	100
<b>A REGULATORY COMPLIANCE</b> .....	<b>102</b>

<b><i>B SAFETY PRECAUTIONS</i></b> .....	<b>108</b>
<i>B.1 SAFETY PRECAUTIONS</i> .....	109
<i>B.1.1 General Safety Precautions</i> .....	109
<i>B.1.2 Anti-static Precautions</i> .....	109
<i>B.1.3 Product Disposal</i> .....	110
<i>B.2 MAINTENANCE AND CLEANING PRECAUTIONS</i> .....	111
<i>B.2.1 Maintenance and Cleaning</i> .....	111
<i>B.2.2 Cleaning Tools</i> .....	111
<b><i>C WATCHDOG TIMER</i></b> .....	<b>113</b>
<b><i>D HAZARDOUS MATERIALS DISCLOSURE</i></b> .....	<b>116</b>



# List of Figures

Figure 1-1: ECN-360A-ULT3.....	2
Figure 1-2: ECN-360A-ULT3 Front Panel.....	5
Figure 1-3: ECN-360A-ULT3 Rear Panel.....	6
Figure 1-4: Physical Dimensions (mm) .....	7
Figure 3-1: Unscrew the Cover.....	14
Figure 3-2: Remove the Cover from ECN-360A-ULT3.....	14
Figure 3-3: HDD Installation .....	15
Figure 3-4: SO-DIMM Socket .....	16
Figure 3-5: SO-DIMM Installation .....	16
Figure 3-6: Mounting Bracket Retention Screws .....	17
Figure 3-7: Power Button.....	18
Figure 4-1: Connector and Jumper Locations.....	20
Figure 4-2: +12V DC-IN Power Connector Location.....	23
Figure 4-3: Audio Connector Location .....	24
Figure 4-4: Battery Connector Location.....	25
Figure 4-5: Buzzer Connector Location .....	26
Figure 4-6: Digital I/O Connector Location .....	27
Figure 4-7: Fan Connector Locations.....	28
Figure 4-8: Front Panel Connector Location .....	29
Figure 4-9: Internal DisplayPort Connector Location.....	30
Figure 4-10: Keyboard and Mouse Connector Location.....	31
Figure 4-11: Backlight Inverter Connector Location.....	32
Figure 4-12: LVDS Connector Location.....	33
Figure 4-13: LAN LED Connector Locations .....	34
Figure 4-14: Full-size PCIe Mini Card Slot Location .....	35
Figure 4-15: Half-size PCIe Mini Slot Location .....	37
Figure 4-16: Power Button Location.....	39
Figure 4-17: Power Button Connector Location.....	39
Figure 4-18: Reset Button Connector Location.....	40
Figure 4-19: RS-232 Serial Port Connector Locations.....	41

Figure 4-20: RS-232/422/485 Connector Location .....	42
Figure 4-21: SATA 6Gb/s Drive Connectors Locations .....	43
Figure 4-22: SATA Power Connector Locations .....	44
Figure 4-23: SMBus Connector Location .....	45
Figure 4-24: SIM Card Slot Location.....	46
Figure 4-25: SPI Flash Connector Location.....	47
Figure 4-26: SPI Flash Connector Location.....	48
Figure 4-27: USB Connector Location.....	49
Figure 4-28: USB Connector Location (Type A).....	50
Figure 4-29: External Peripheral Interface Connector .....	51
Figure 4-30: HDMI Connector Pinout Locations.....	52
Figure 4-31: LAN Connector.....	53
Figure 4-32: AT/ATX Mode Select Switch Location .....	54
Figure 4-33: Clear CMOS Button Location.....	55
Figure 4-34: Flash Descriptor Security Override Jumper Location .....	56
Figure 4-35: HDMI/DP Select Switch Location.....	57
Figure 4-36: LVDS Panel Resolution Select Switch Location.....	58
Figure 4-37: LVDS Voltage Select Jumper Location.....	59

# List of Tables

<b>Table 1-1: ECN-360A-ULT3 Model Variations .....</b>	<b>2</b>
<b>Table 1-2: Technical Specifications .....</b>	<b>5</b>
<b>Table 4-1: Peripheral Interface Connectors .....</b>	<b>21</b>
<b>Table 4-2: Rear Panel Connectors .....</b>	<b>22</b>
<b>Table 4-3: +12V DC-IN Power Connector Pinouts .....</b>	<b>23</b>
<b>Table 4-4: Audio Connector Pinouts .....</b>	<b>24</b>
<b>Table 4-5: Battery Connector Pinouts .....</b>	<b>26</b>
<b>Table 4-6: Buzzer Connector Pinouts .....</b>	<b>26</b>
<b>Table 4-7: Digital I/O Connector Pinouts .....</b>	<b>27</b>
<b>Table 4-8: Fan Connector Pinouts .....</b>	<b>28</b>
<b>Table 4-9: Front Panel Connector Pinouts .....</b>	<b>29</b>
<b>Table 4-10: Internal DisplayPort Connector Pinouts .....</b>	<b>31</b>
<b>Table 4-11: Keyboard and Mouse Connector Pinouts .....</b>	<b>32</b>
<b>Table 4-12: Backlight Inverter Connector Pinouts .....</b>	<b>32</b>
<b>Table 4-13: LVDS Connector Pinouts .....</b>	<b>34</b>
<b>Table 4-14: LAN LED Connector Pinouts .....</b>	<b>34</b>
<b>Table 4-15: Full-size PCIe Mini Card Slot Pinouts .....</b>	<b>36</b>
<b>Table 4-16: Half-size PCIe Mini Slot Pinouts .....</b>	<b>38</b>
<b>Table 4-17: Power Button Connector Pinouts .....</b>	<b>39</b>
<b>Table 4-18: Reset Button Connector Pinouts .....</b>	<b>40</b>
<b>Table 4-19: RS-232 Serial Port Connector Pinouts .....</b>	<b>41</b>
<b>Table 4-20: RS-232/422/485 Connector Pinouts .....</b>	<b>42</b>
<b>Table 4-21: DB-9 RS-422/485 Pinouts .....</b>	<b>43</b>
<b>Table 4-22: SATA Power Connector Pinouts .....</b>	<b>44</b>
<b>Table 4-23: SMBus Connector Pinouts .....</b>	<b>45</b>
<b>Table 4-24: SPI Flash Connector Pinouts .....</b>	<b>47</b>
<b>Table 4-25: SPI Flash Connector Pinouts .....</b>	<b>48</b>
<b>Table 4-26: USB Connector Pinouts .....</b>	<b>49</b>
<b>Table 4-27: USB Connector Pinouts (Type A) .....</b>	<b>50</b>
<b>Table 4-28: HDMI Connector Pinouts .....</b>	<b>52</b>
<b>Table 4-29: LAN Pinouts .....</b>	<b>53</b>

<b>Table 4-30: USB 3.0 Port Pinouts</b> .....	<b>53</b>
<b>Table 4-31: AT/ATX Mode Select Switch Settings</b> .....	<b>54</b>
<b>Table 4-32: Flash Descriptor Security Override Jumper Settings</b> .....	<b>55</b>
<b>Table 4-33: HDMI/DP Select Switch Settings</b> .....	<b>57</b>
<b>Table 4-34: LVDS Panel Resolution Selection</b> .....	<b>58</b>
<b>Table 4-35: LVDS Voltage Select Jumper Settings</b> .....	<b>59</b>

# List of BIOS Menus

BIOS Menu 1: Main .....	65
BIOS Menu 2: Advanced .....	66
BIOS Menu 3: ACPI Settings .....	67
BIOS Menu 4: AMT Configuration .....	68
BIOS Menu 5: F81866 Super IO Configuration .....	69
BIOS Menu 6: Serial Port n Configuration .....	70
BIOS Menu 7: iWDD H/W Monitor .....	73
BIOS Menu 8: Smart Fan Mode Configuration .....	74
BIOS Menu 9: RTC Wake Settings .....	77
BIOS Menu 10: Serial Port Console Redirection .....	78
BIOS Menu 11: Legacy Console Redirection Settings .....	79
BIOS Menu 12: Console Redirection Settings .....	80
BIOS Menu 13: CPU Configuration .....	82
BIOS Menu 14: SATA Configuration .....	84
BIOS Menu 15: USB Configuration .....	86
BIOS Menu 16: IEI Feature .....	87
BIOS Menu 17: Chipset .....	88
BIOS Menu 18: System Agent (SA) Configuration .....	88
BIOS Menu 19: Graphics Configuration .....	89
BIOS Menu 20: LCD Control .....	91
BIOS Menu 21: Memory Configuration .....	93
BIOS Menu 22: PCH-IO Configuration .....	93
BIOS Menu 23: PCI Express Configuration .....	94
BIOS Menu 24: HD Audio Configuration .....	96
BIOS Menu 25: Security .....	97
BIOS Menu 26: Boot .....	98
BIOS Menu 27: Exit .....	100



Chapter

1

# Introduction

---

## 1.1 Overview



**Figure 1-1: ECN-360A-ULT3**

The ECN-360A-ULT3 is a platform based on Intel® Core™ i5-6300U or Intel® Celeron® 3855U processor.

The ECN-360A-ULT3 contains two HDMI video outputs, which can be applied to multi-display application and support high Full HD video quality. The ECN-360A-ULT3 is equipped with an abundant of I/O ports. Four USB 3.0 ports provide flexible expansion options. Serial device connectivity is provided by two RS-232 ports and one RS-232/422/485 port.

## 1.2 Model Variations

The model variations of the ECN-360A-ULT3 Series are listed below.

Model No.	Processor	Power	Memory
ECN-360A-ULT3-i5/4G-R10	Intel® Core™ i5-6300U 3.0GHz	12 V DC	4GB memory pre-installed
ECN-360A-ULT3-i5/WD/4G-R10 (Optional)		9 V~36 V DC	4GB memory pre-installed
ECN-360A-ULT3-CE/4G-R10	Intel® Celeron® 3855U 1.6GHz	12 V DC	4GB memory pre-installed
ECN-360A-ULT3-CE/WD/4G-R10 (Optional)		9 V~36 V DC	4GB memory pre-installed

**Table 1-1: ECN-360A-ULT3 Model Variations**

## ECN-360A-ULT3 Embedded System

### 1.3 Features

The ECN-360A-ULT3 features are listed below:

- On-board CPU
  - » i5-6300U dual-core up to 3.0GHz
  - » 3855U dual-core up to 1.6GHz
- Two 2.5" SATA 6Gb/s HDD/SSD drive bay
- Operating temperature: -20°C ~ 50°C
- Two flexible E-Window for modularized expansion I/O

### 1.4 Technical Specifications

The ECN-360A-ULT3 technical specifications are listed in **Table 1-2**.

Specifications	
Chassis	
Color	Black
Dimensions (WxDxH)	255 x 130 x 75 mm
System Fan	Fanless
Chassis Construction	SECC
<b>Motherboard</b>	
Motherboard Model	NANO-ULT3
SBC Size (mm)	EPIC, 165 x 115
Processor	Intel® Core™ i5-6300U Intel® Celeron® 3855U
System Memory	2 x 260-pin 2133/1866 MHz dual-channel DDR4 SO-DIMMs support up to 32GB Pre-install 4GB DDR4
<b>Storage</b>	
Hard Drive	2 x 2.5" SATA HDD bay (No RAID support)

Specifications	
I/O Interfaces	
USB	4 x USB 3.0 ports
Ethernet	2 x RJ-45 LAN1: Intel® I219-LM LAN2: Intel® I211-AT
COM Port	1 x RS-232/422/485 2 x RS-232
Digital I/O	8-bit Digital I/O
Display	2 x HDMI
Resolution	HDMI: up to 4096x2160@24Hz
Audio	1 x Line-out
Wireless	2 x 802.11b/g/n (optional)
Expansions	
PCIe Mini	1 x Full-size PCIe Mini card slot (with SIM holder & mSATA support, 3855U do not support mSATA) 1 x Half-size PCIe Mini card slot <i>*3855U belongs to Skylake ULT Base series CPU, PCIe signal support only PCIe Gen 2</i>
Power	
Power Input	DC 12V (Optional 9~36V) Power 1: DC jack Power 2: Terminal block
Power Consumption	12 V@2.4 A (Intel® i5-6300U with 4GB DDR4 memory)
Reliability	
Mounting	Wall mount, VESA 100
Operating Temperature	-20°C~50°C with air flow (SSD)
Humidity	5% ~ 95%, non-condensing
Operating Shock	Half-sine wave shock 5G, 11ms, 3 shocks per axis

## ECN-360A-ULT3 Embedded System

Specifications	
Operating Vibration	MIL-STD-810F 514.5C-2 (SSD)
Weight (Net/Gross)	2.2 kg/3 kg

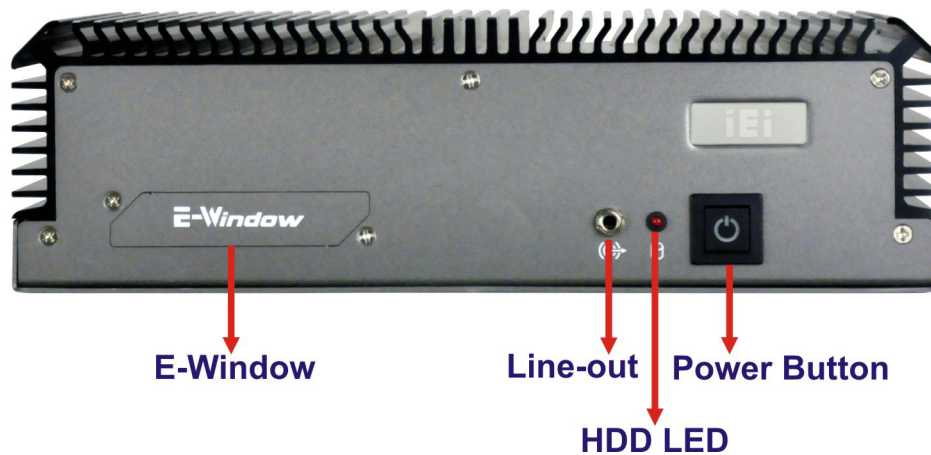
**Table 1-2: Technical Specifications**

### 1.5 Front Panel

The ECN-360A-ULT3 front panel contains:

- 1 x E-Window
- 1 x HDD LED
- 1 x Line-out port
- 1 x Power button

An overview of the front panel is shown in **Figure 1-2**.



**Figure 1-2: ECN-360A-ULT3 Front Panel**

### 1.6 Rear Panel

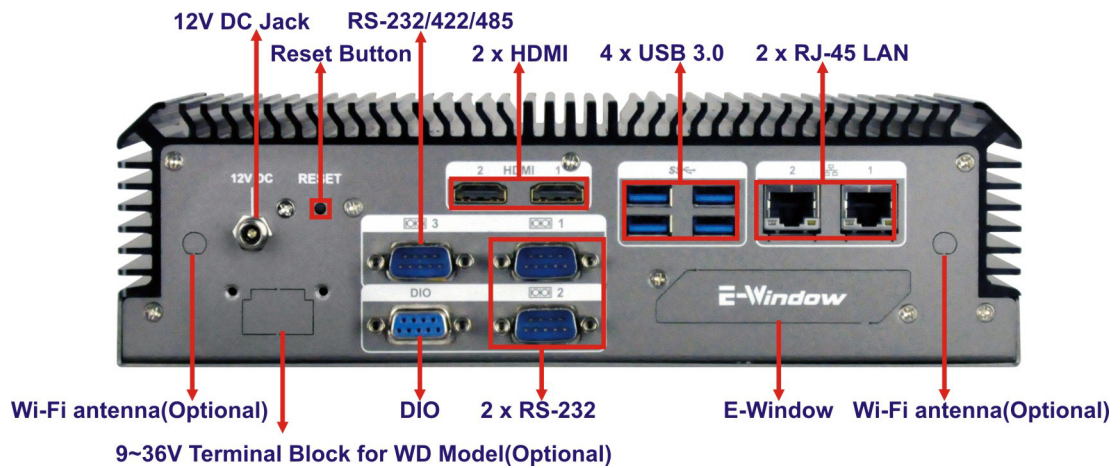
The ECN-360A-ULT3 rear panel contains:

- 1 x DC jack for 12 V power input
- 1 x 3-pin terminal block for 9 V ~ 36 V power input for WD Model (Optional)
- 1 x DIO port



- 1 x E-Window
- 2 x HDMI ports
- 4 x USB 3.0 ports
- 1 x Reset button
- 2 x RJ-45 LAN ports
- 2 x RS-232 serial ports
- 1 x RS-232/422/485 serial port
- 2 x Wi-Fi antenna connectors (Optional)

An overview of the rear panel is shown in **Figure 1-3** below.



**Figure 1-3: ECN-360A-ULT3 Rear Panel**

ECN-360A-ULT3 Embedded System

1.7 Dimensions

The physical dimensions are shown below:

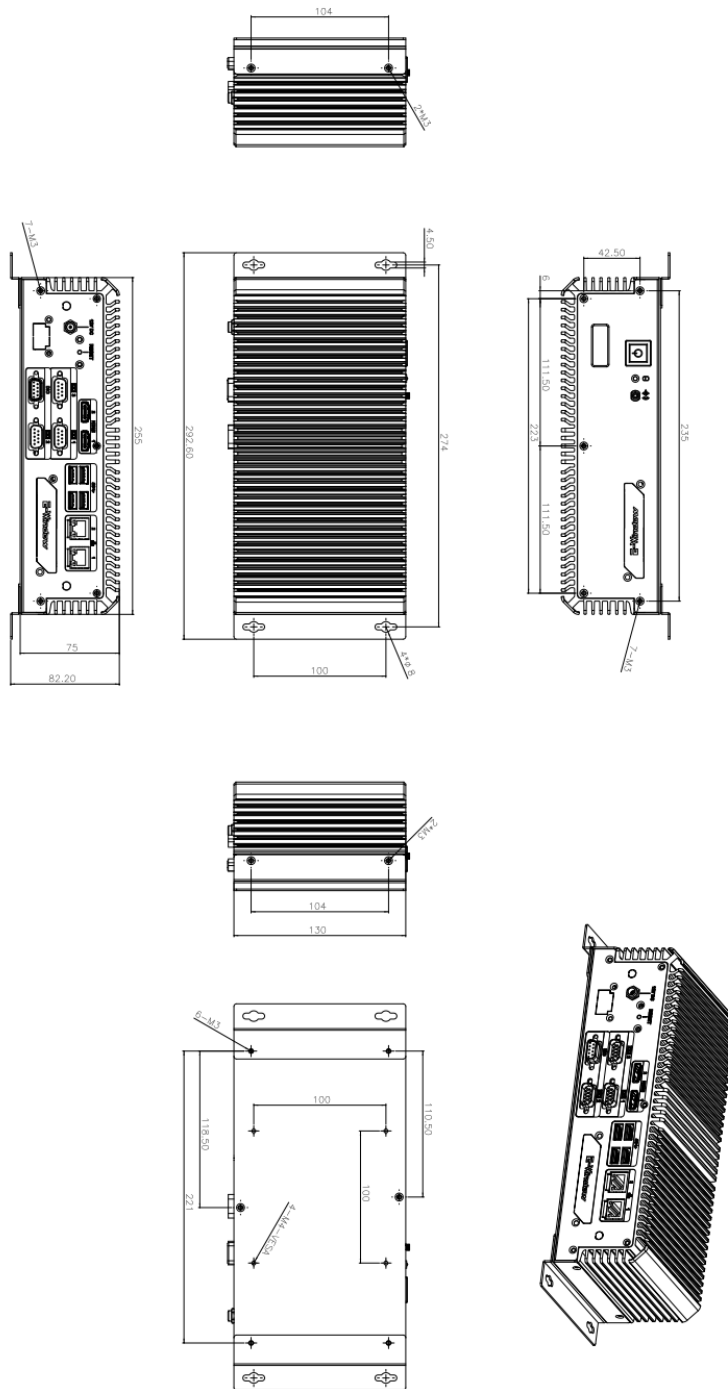


Figure 1-4: Physical Dimensions (mm)

Chapter

2

# Unpacking

---

## 2.1 Anti-static Precautions

---



### WARNING:

Failure to take ESD precautions during installation may result in permanent damage to the ECN-360A-ULT3 and severe injury to the user.

---

Electrostatic discharge (ESD) can cause serious damage to electronic components, including the ECN-360A-ULT3. Dry climates are especially susceptible to ESD. It is therefore critical that whenever the ECN-360A-ULT3 or any other electrical component is handled, the following anti-static precautions are strictly adhered to.

- **Wear an anti-static wristband:** Wearing a simple anti-static wristband can help to prevent ESD from damaging the board.
- **Self-grounding:** Touch any grounded conducting material before handling the board. During the time the board is handled, frequently touch any conducting materials that are connected to the ground.
- **Use an anti-static pad:** When configuring the ECN-360A-ULT3, place it on an anti-static pad. This reduces the possibility of ESD damaging the ECN-360A-ULT3.

## 2.2 Unpacking Precautions

When the ECN-360A-ULT3 is unpacked, please do the following:

- Follow the anti-static precautions outlined in **Section 2.1**.
- Make sure the packing box is facing upwards so the ECN-360A-ULT3 does not fall out of the box.
- Make sure all the components shown in **Section 2.3** are present.



### 2.3 1Unpacking Checklist



**NOTE:**


If some of the components listed in the checklist below are missing, please do not proceed with the installation. Contact the IEI reseller or vendor you purchased the ECN-360A-ULT3 from or contact an IEI sales representative directly. To contact an IEI sales representative, please send an email to [sales@iei.com.tw](mailto:sales@iei.com.tw).

The ECN-360A-ULT3 is shipped with the following components:

Quantity	Item and Part Number	Image
Standard		
1	ECN-360A-ULT3 Series	
2	Mounting brackets	
1	Screw set	



The following table lists the optional items that can be purchased separately.

Optional	
<p>FSP060-DIBAN2, 12V 60W AC/DC Adapter (P/N: 63040-010060-120-RS)</p>	
<p>PCIe mini card supports 1-port GbE with REALTEK RTL8111E controller, with PMS 194C I/O bracket and 150 mm cable (P/N: E-MPCIE-LAN03-R10)</p>	
<p>PCIe mini card supports PCIe mini card supports 2-port GbE with Intel® I211 controller, with PMS 194C I/O bracket and 150mm cable (P/N: E-MPCIE-DLAN03-R10)</p>	

Chapter

3

# Installation

---

### 3.1 Installation Precautions

During installation, be aware of the precautions below:

- **Read the user manual:** The user manual provides a complete description of the ECN-360A-ULT3, installation instructions and configuration options.
- **DANGER! Disconnect Power:** Power to the ECN-360A-ULT3 must be disconnected during the installation process, or before any attempt is made to access the rear panel. Electric shock and personal injury might occur if the rear panel of the ECN-360A-ULT3 is opened while the power cord is still connected to an electrical outlet.
- **Qualified Personnel:** The ECN-360A-ULT3 must be installed and operated only by trained and qualified personnel. Maintenance, upgrades, or repairs may only be carried out by qualified personnel who are familiar with the associated dangers.
- **Air Circulation:** Make sure there is sufficient air circulation when installing the ECN-360A-ULT3. The ECN-360A-ULT3's cooling vents must not be obstructed by any objects. Blocking the vents can cause overheating of the ECN-360A-ULT3. Leave at least 5 cm of clearance around the ECN-360A-ULT3 to prevent overheating.
- **Grounding:** The ECN-360A-ULT3 should be properly grounded. The voltage feeds must not be overloaded. Adjust the cabling and provide external overcharge protection per the electrical values indicated on the label attached to the back of the ECN-360A-ULT3.

### 3.2 Hard Disk Drive (HDD) Installation

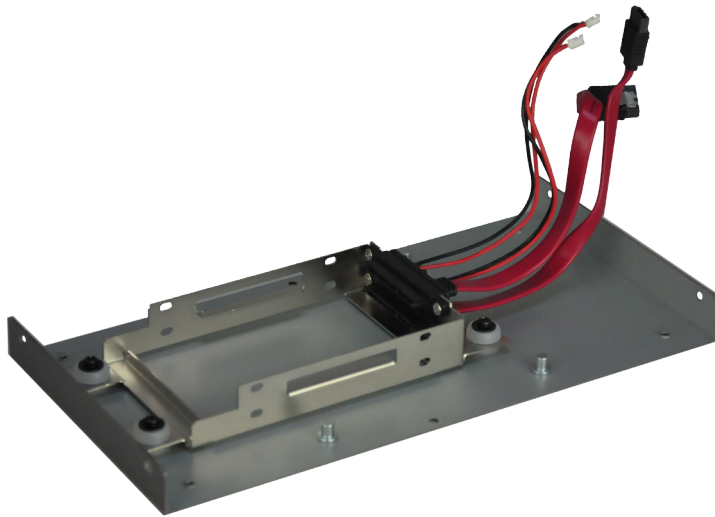
To install the hard drive, please follow the steps below:

- Step 1:** Remove four retention screws from the side panel and two retention screws from the bottom panel, and then lift the cover up gently (**Figure 3-1**).



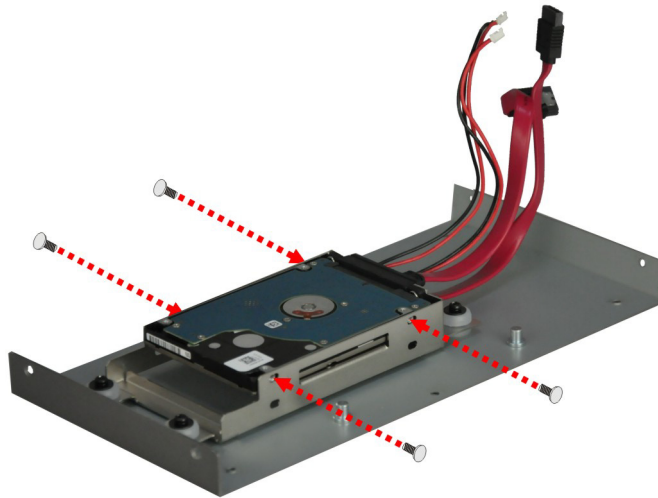
**Figure 3-1: Unscrew the Cover**

**Step 2:** Unplug the SATA signal and power cables connected to the ECN-360A-ULT3, and then put the cover on a flat surface (**Figure 3-2**).



**Figure 3-2: Remove the Cover from ECN-360A-ULT3**

**Step 3:** Attach the HDD to the HDD bracket, and then secure the HDD with the HDD bracket by four retention screws (**Figure 3-3**).



**Figure 3-3: HDD Installation**

**Step 4:** Reconnect the SATA signal and power cables to the ECN-360A-ULT3.

**Step 5:** Reinstall the cover.

### 3.3 SO-DIMM Installation



#### **WARNING:**

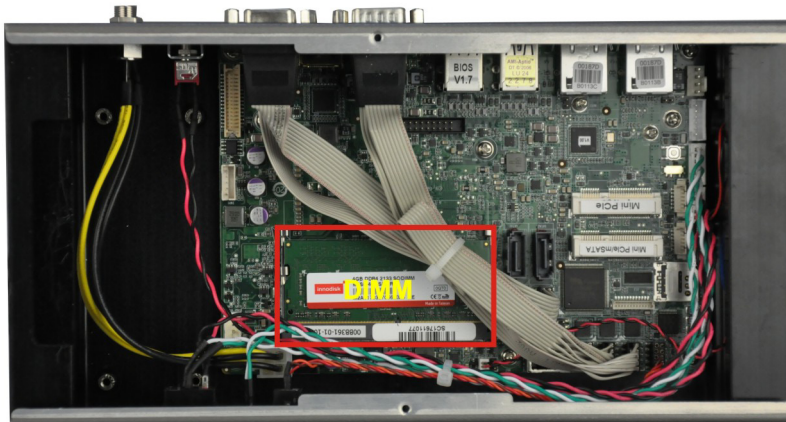
Using incorrectly specified SO-DIMM may cause permanent damage to the ECN-360A-ULT3. Please make sure the purchased SO-DIMM complies with the memory specifications of the ECN-360A-ULT3.

To install a SO-DIMM into a SO-DIMM socket, please follow the steps below.

**Step 1:** Remove four retention screws from the side panel and two retention screws from the bottom panel, and then lift the cover up gently (**Figure 3-1**).

**Step 2:** Locate the SO-DIMM socket on the motherboard (**Figure 3-4**).

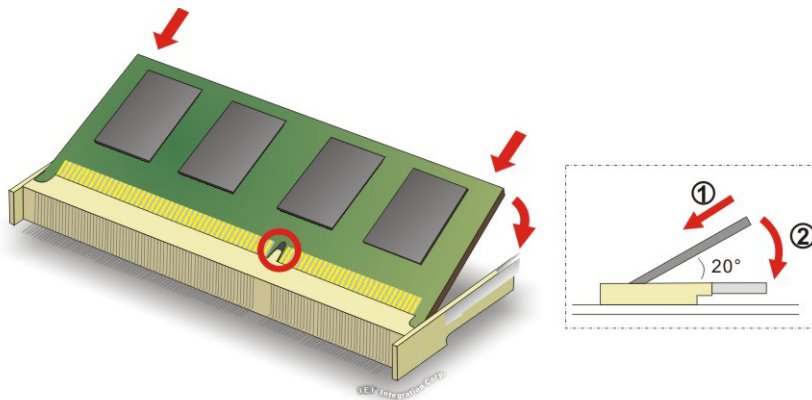




**Figure 3-4: SO-DIMM Socket**

**Step 3:** Align the SO-DIMM with the socket. The SO-DIMM must be oriented in such a way that the notch in the middle of the SO-DIMM must be aligned with the plastic bridge in the socket (**Figure 3-5**).

**Step 4:** Push the SO-DIMM into the socket at an angle (**Figure 3-5**).



**Figure 3-5: SO-DIMM Installation**

**Step 5:** Gently pull the arms of the SO-DIMM socket out and push the rear of the SO-DIMM down (**Figure 3-5**).

**Step 6:** Release the arms on the SO-DIMM socket. They clip into place and secure the SO-DIMM in the socket.

## ECN-360A-ULT3 Embedded System

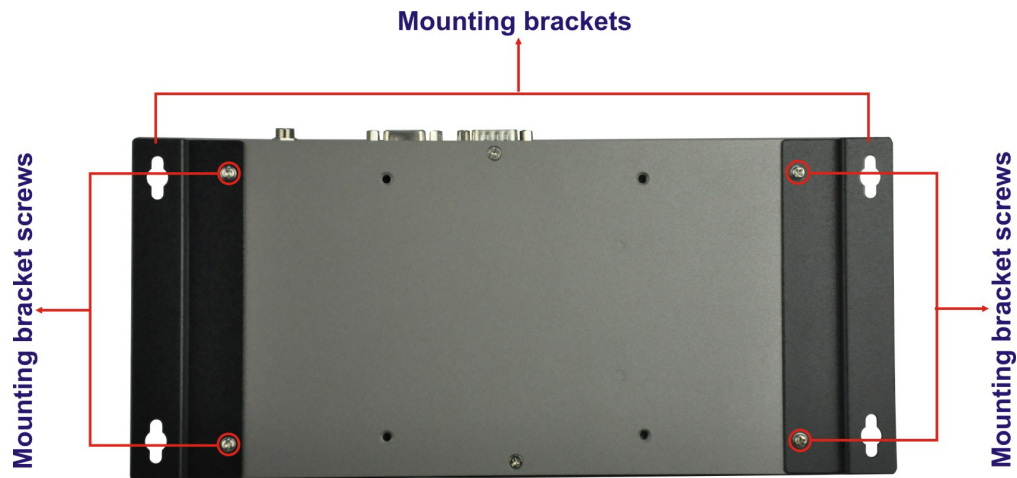
**Step 7:** Reinstall the cover that was previously removed in the same position it was before.

### 3.4 Mounting the System with Mounting Brackets

To mount the embedded system onto a wall or some other surface using the two mounting brackets, please follow the steps below.

**Step 1:** Turn the embedded system over.

**Step 2:** Align the two retention screw holes in each bracket with the corresponding retention screw holes on the sides of the bottom surface (**Figure 3-6**).



**Figure 3-6: Mounting Bracket Retention Screws**

**Step 3:** Secure the brackets to the system by tightening two retention screws into each bracket (**Figure 3-6**).

**Step 4:** Drill holes in the intended installation surface.

**Step 5:** Align the mounting holes in the sides of the mounting brackets with the predrilled holes in the mounting surface.

**Step 6:** Insert four retention screws, two in each bracket, to secure the system to the wall.

### 3.5 Powering On/Off the System

---

**WARNING:**

Make sure a power supply with the correct input voltage is being fed into the system. Incorrect voltages applied to the system may cause damage to the internal electronic components and may also cause injury to the user.

---

- **Power on** the system: press the power button for 3 second
- **Power off** the system: press the power button for 6 second



Figure 3-7: Power Button

Chapter

4

# System Motherboard

---

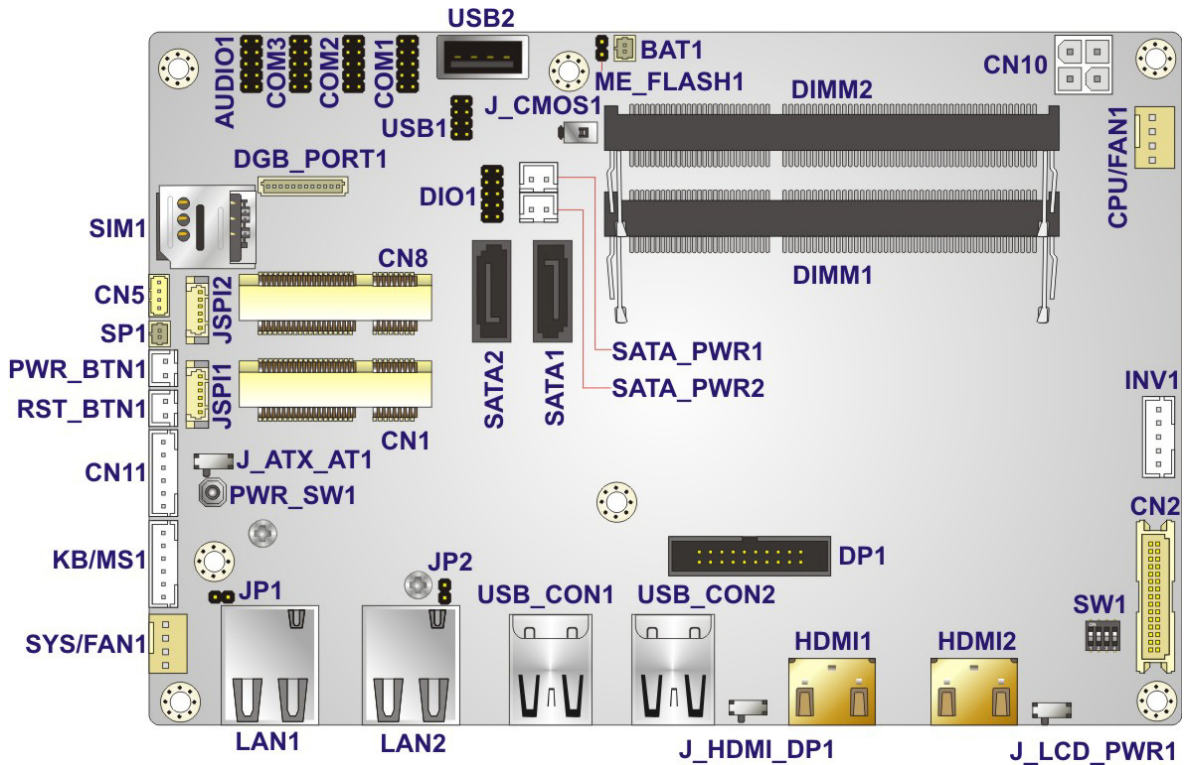


## 4.1 Peripheral Interface Connectors

This chapter details all the jumpers and connectors.

### 4.1.1 Layout

The figures below show all the connectors and jumpers.



**Figure 4-1: Connector and Jumper Locations**

### 4.1.2 Peripheral Interface Connectors

The table below lists all the connectors on the board.

Connector	Type	Label
+12V DC-IN power connector	4-pin Molex	CN10
Audio connector	10-pin header	AUDIO1
Battery connector	2-pin wafer	BAT1
Buzz connector	2-pin wafer	SP1



Digital I/O connector	10-pin header	DIO1
Debug card connector	12-pin wafer	DBG_PORT1
Fan connector, CPU	4-pin wafer	CPU/FAN1
Fan connector, system	4-pin wafer	SYS/FAN1
Front panel connector	6-pin wafer	CN11
Internal DisplayPort connector	20-pin box header	DP1
Keyboard & mouse connector	6-pin wafer	KB/MS1
LCD backlight inverter connector	5-pin wafer	INV1
LVDS LCD connector	30-pin crimp	CN2
LAN LED connectors	2-pin header	JP1, JP2
Memory slot	260-pin DDR4 SO-DIMM	DIMM1, DIMM2
PCIe Mini card slot, half-size	Half-size PCIe Mini slot	CN1
PCIe Mini card slot, full-size	Full-size PCIe Mini slot	CN8
Power button (on board)	Push button	PWR_SW1
Power button connector	2-pin wafer	PWR_BTN1
Reset button connector	2-pin wafer	RST_BTN1
RS-232 serial port connectors	10-pin header	COM1, COM2
RS-232/422/485 serial port connector	10-pin header	COM3
SATA 6Gb/s drive connectors	7-pin SATA connector	SATA1, SATA2
SATA power connectors	2-pin wafer	SATA_PWR1, SATA_PWR2
SMBus connector	4-pin wafer	CN5
SIM card slot	SIM slot	SIM1
SPI flash connector, BIOS	6-pin wafer	JSPI1
SPI flash connector, EC	6-pin wafer	JSPI2
USB 2.0 connector	8-pin header	USB1
USB 2.0 connector	USB type A	USB2

**Table 4-1: Peripheral Interface Connectors**

### 4.1.3 External Interface Panel Connectors

The table below lists the connectors on the external I/O panel.

Connector	Type	Label
LAN connectors	RJ-45	LAN1, LAN2
HDMI connectors	HDMI	HDMI1, HDMI2
USB 3.0 connectors	USB 3.0	USB_CON1, USB_CON2

**Table 4-2: Rear Panel Connectors**

ECN-360A-ULT3 Embedded System

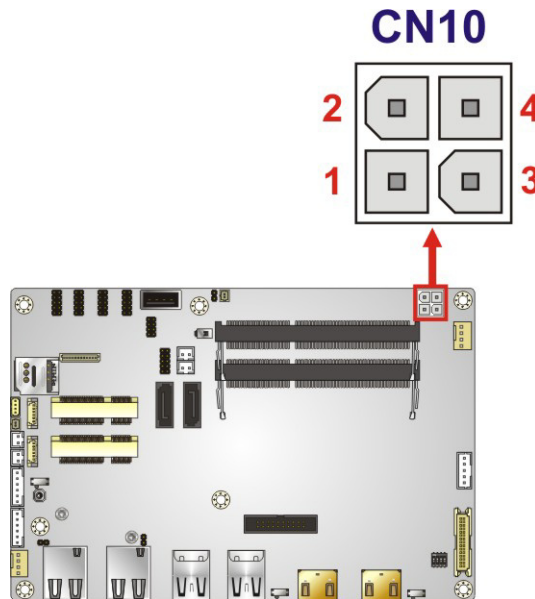
## 4.2 Internal Peripheral Connectors

The section describes all of the connectors on the ECN-360A-ULT3.

### 4.2.1 +12V DC-IN Power Connector

- CN Label: CN10
- CN Type: 4-pin Molex, p=4.2 mm
- CN Location: See **Figure 4-2**
- CN Pinouts: See **Table 4-3**

The connector supports the +12V power supply.



**Figure 4-2: +12V DC-IN Power Connector Location**

PIN NO.	DESCRIPTION	PIN NO.	DESCRIPTION
1	GND	2	GND
3	+12V	4	+12V

**Table 4-3: +12V DC-IN Power Connector Pinouts**

### 4.2.2 Audio Connector

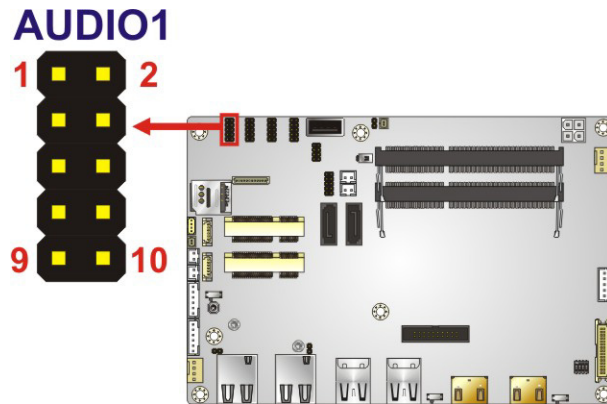
- CN Label: **AUDIO1**

CN Type: 10-pin header, p=2.00 mm

CN Location: See **Figure 4-3**

CN Pinouts: See **Table 4-4**

The audio connector is connected to external audio devices including speakers and microphones for the input and output of audio signals to and from the system.



**Figure 4-3: Audio Connector Location**

PIN NO.	DESCRIPTION	PIN NO.	DESCRIPTION
1	LINE_OUTR	2	LINEIN_R
3	ANALOG_GND	4	ANALOG_GND
5	LINE_OUTL	6	LINEIN_L
7	ANALOG_GND	8	ANALOG_GND
9	MICIN1	10	MICIN2

**Table 4-4: Audio Connector Pinouts**

### 4.2.3 Battery Connector

**CAUTION:**

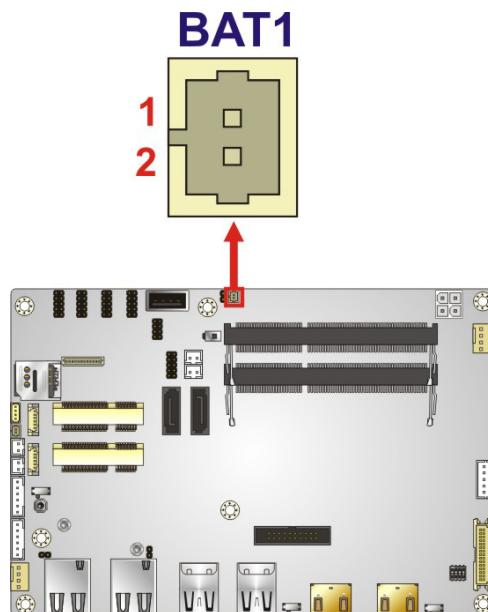
Risk of explosion if battery is replaced by an incorrect type. Only certified engineers should replace the on-board battery.

Dispose of used batteries according to instructions and local regulations.

---

CN Label:	<b>BAT1</b>
CN Type:	2-pin wafer, p=1.25 mm
CN Location:	See <b>Figure 4-4</b>
CN Pinouts:	See <b>Table 4-5</b>

The battery connector is connected to the system battery. The battery provides power to the system clock to retain the time when power is turned off.



**Figure 4-4: Battery Connector Location**



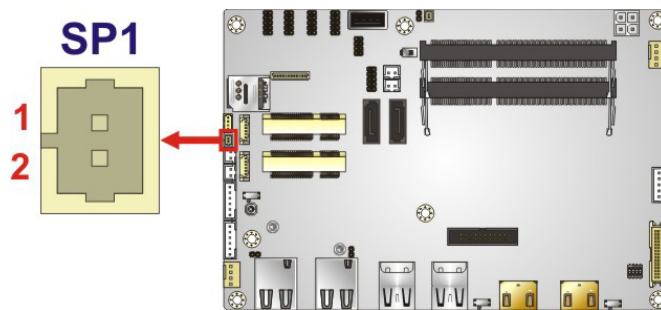
Pin	Description
1	VBAT+
2	GND

**Table 4-5: Battery Connector Pinouts**

#### 4.2.4 Buzzer Connector

- CN Label: **SP1**
- CN Type: 2-pin wafer, p=1.25 mm
- CN Location: See **Figure 3-5**
- CN Pinouts: See **Table 4-6**

The buzzer connector is connected to the buzzer.



**Figure 4-5: Buzzer Connector Location**

Pin	Description
1	Buzzer+
2	Buzzer-

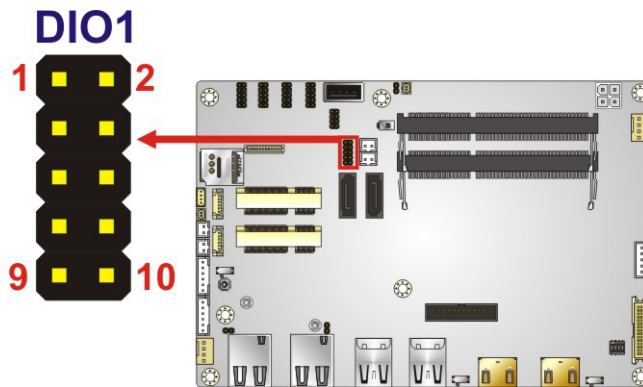
**Table 4-6: Buzzer Connector Pinouts**

ECN-360A-ULT3 Embedded System

4.2.5 Digital I/O Connector

- CN Label: DIO1
- CN Type: 10-pin header, p=2.00 mm
- CN Location: See **Figure 4-6**
- CN Pinouts: See **Table 4-7**

The 8-bit digital I/O connector provides programmable input and output for external devices.



**Figure 4-6: Digital I/O Connector Location**

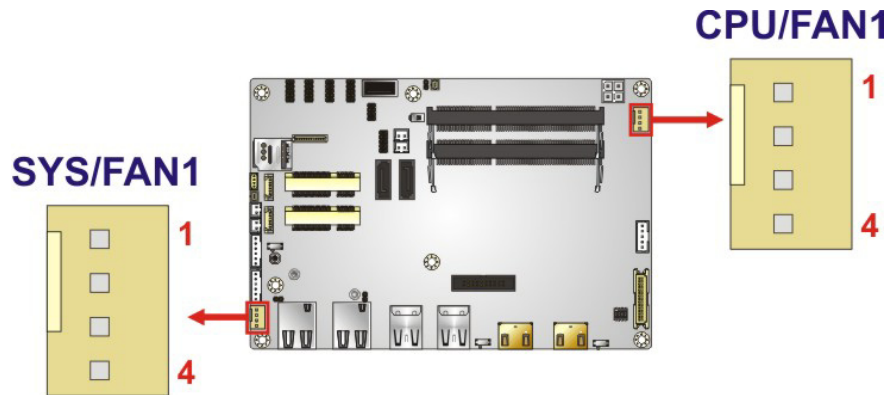
PIN NO.	DESCRIPTION	PIN NO.	DESCRIPTION
1	GND	2	+5V
3	DOUT3	4	DOUT2
5	DOUT1	6	DOUT0
7	DIN3	8	DIN2
9	DIN1	10	DIN0

**Table 4-7: Digital I/O Connector Pinouts**

### 4.2.6 Fan Connectors

- CN Label: CPU/FAN1, SYS/FAN1
- CN Type: 4-pin wafer, p=2.54 mm
- CN Location: See **Figure 4-7**
- CN Pinouts: See **Table 4-8**

The fan connector attaches to a cooling fan.



**Figure 4-7: Fan Connector Locations**

Pin	Description
1	GND
2	+12V
3	FANIO
4	PWM

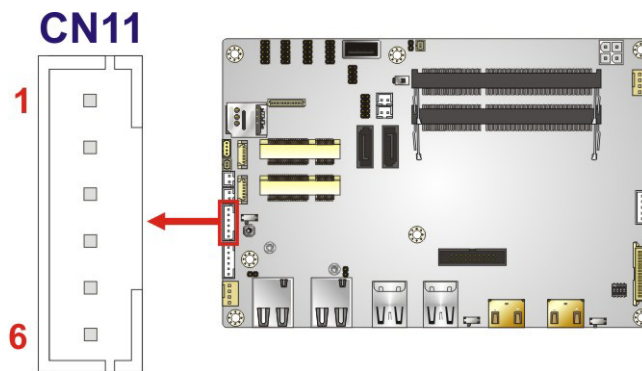
**Table 4-8: Fan Connector Pinouts**

## ECN-360A-ULT3 Embedded System

### 4.2.7 Front Panel Connector

- CN Label: CN11
- CN Type: 6-pin wafer, p=2.00 mm
- CN Location: See **Figure 4-8**
- CN Pinouts: See **Table 4-9**

The front panel connector connects to the power LED indicator and HDD LED indicator on the system front panel.



**Figure 4-8: Front Panel Connector Location**

Pin	Description
1	VCC
2	GND
3	PWR_LED+
4	PWR_LED-
5	HDD_LED+
6	HDD_LED-

**Table 4-9: Front Panel Connector Pinouts**

### 4.2.8 Internal DisplayPort Connector

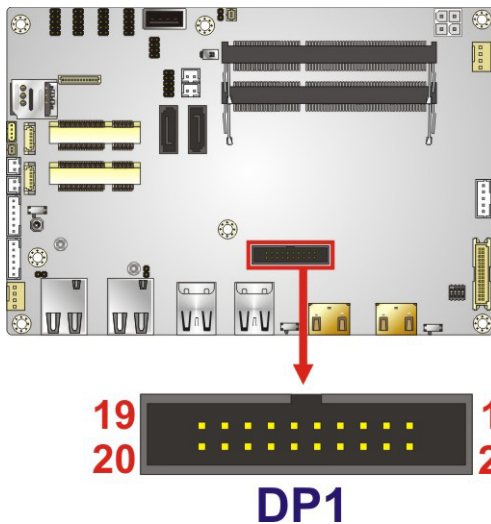


**NOTE:**

The iDP connector is disabled by default since the iDP connector is co-lay with the HDMI1 connector. To enable the iDP connector, use the HDMI/DP select switch to configure the settings. Please refer to **Section 4.4.4** for detailed information.

- CN Label: DP 1
- CN Type: 20-pin box header, p=2.00 mm
- CN Location: See **Figure 4-9**
- CN Pinouts: See **Table 4-10**

The internal DisplayPort (iDP) connector supports HDMI, LVDS, VGA, DVI and DisplayPort devices with up to 4096x2304 resolutions.



**Figure 4-9: Internal DisplayPort Connector Location**



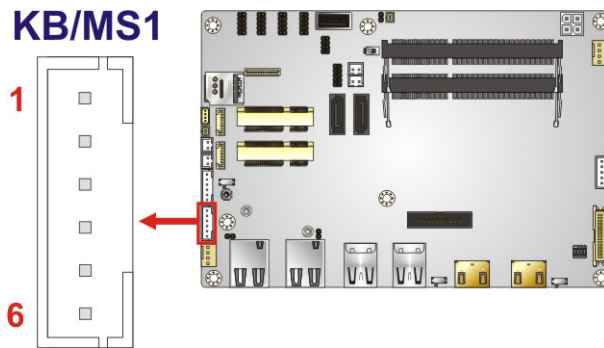
Pin	Description	Pin	Description
1	HPD	2	AUX+
3	GND	4	AUX-
5	CAD	6	GND
7	GND	8	Lane2+
9	Lane3+	10	Lane2-
11	Lane3-	12	GND
13	GND	14	Lane0+
15	Lane1+	16	Lane0-
17	Lane1-	18	VCC3
19	VCC5	20	NC

**Table 4-10: Internal DisplayPort Connector Pinouts**

#### 4.2.9 Keyboard and Mouse Connector

- CN Label: KB/MS 1
- CN Type: 6-pin wafer, p=2.00 mm
- CN Location: See **Figure 4-10**
- CN Pinouts: See **Table 4-11**

The keyboard/mouse connector connects to a PS/2 Y-cable that can be connected to a PS/2 keyboard and mouse.



**Figure 4-10: Keyboard and Mouse Connector Location**

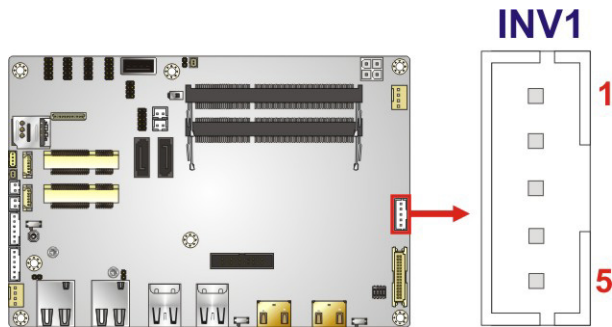
Pin	Description
1	VCC5V
2	Mouse Data
3	Mouse Clock
4	Keyboard Data
5	Keyboard Clock
6	GND

**Table 4-11: Keyboard and Mouse Connector Pinouts**

#### 4.2.10 LVDS Backlight Inverter Connector

- CN Label: INV1
- CN Type: 5-pin wafer, p=2.00 mm
- CN Location: See **Figure 3-11**
- CN Pinouts: See **Table 4-12**

The backlight inverter connector provides power to an LCD panel.



**Figure 4-11: Backlight Inverter Connector Location**

Pin	Description
1	LCD_BKLTCTL
2	GND
3	+12V
4	GND
5	BACKLIGHT_ENABLE

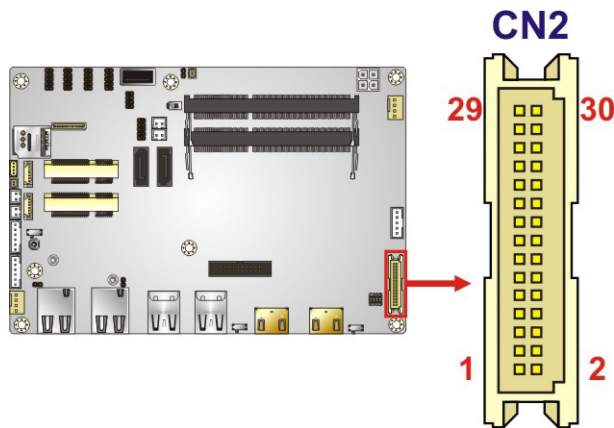
**Table 4-12: Backlight Inverter Connector Pinouts**

ECN-360A-ULT3 Embedded System

4.2.11 LVDS LCD Connector

- CN Label: CN2
- CN Type: 30-pin crimp, p=1.25 mm
- CN Location: See **Figure 4-12**
- CN Pinouts: See **Table 4-13**

The LVDS connector is for an LCD panel to connect to the board.



**Figure 4-12: LVDS Connector Location**

Pin	Description	Pin	Description
1	GROUND	2	GROUND
3	LVDS_A_TX0-P	4	LVDS_A_TX0-N
5	LVDS_A_TX1-P	6	LVDS_A_TX1-N
7	LVDS_A_TX2-P	8	LVDS_A_TX2-N
9	LVDS_A_TXCLK-P	10	LVDS_A_TXCLK-N
11	LVDS_A_TX3-P	12	LVDS_A_TX3-N
13	GROUND	14	GROUND
15	LVDS_B_TX0-P	16	LVDS_B_TX0-N
17	LVDS_B_TX1-P	18	LVDS_B_TX1-N
19	LVDS_B_TX2-P	20	LVDS_B_TX2-N
21	LVDS_B_TXCLK-P	22	LVDS_B_TXCLK-N
23	LVDS_B_TX3-P	24	LVDS_B_TX3-N
25	GROUND	26	GROUND

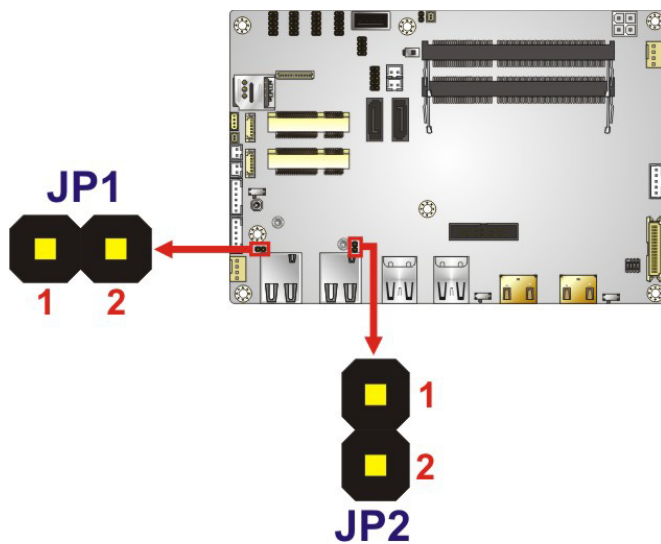
Pin	Description	Pin	Description
27	+LCD VCC	28	+LCD VCC
29	+LCD VCC	30	+LCD VCC

**Table 4-13: LVDS Connector Pinouts**

4.2.12 LAN LED Connectors

- CN Label: JP1, JP2
- CN Type: 2-pin header, p=2.00 mm
- CN Location: See **Figure 4-13**
- CN Pinouts: See **Table 4-14**

The LAN LED connectors connect to the LAN link LEDs on the system.



**Figure 4-13: LAN LED Connector Locations**

Pin	Description
1	+3.3VLAN
2	LAN_LED_LINK#

**Table 4-14: LAN LED Connector Pinouts**

## ECN-360A-ULT3 Embedded System

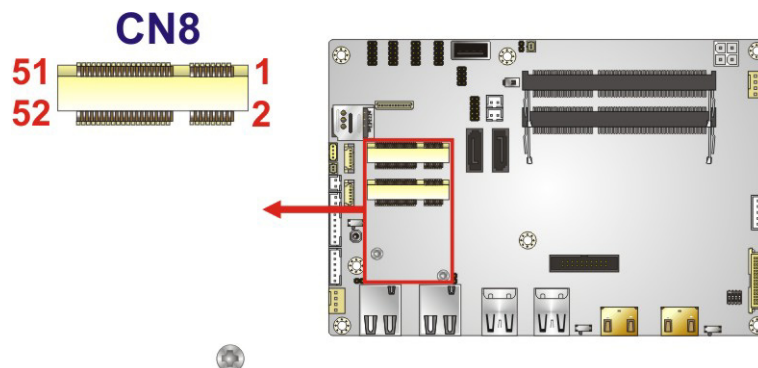
## 4.2.13 PCIe Mini Card Slot, Full-size

CN Label:	CN8
CN Type:	Full-size PCIe Mini card slot
CN Location:	See <b>Figure 4-14</b>
CN Pinouts:	See <b>Table 4-15</b>

The PCIe Mini card slot supports PCIe Mini cards with USB interface, including mSATA modules and 3G modules.

**NOTE:**

1. The ECN-360A-ULT3-CE SKU with Intel® Celeron® CPU do not support mSATA modules.
2. The PCIe Mini slots on the ECN-360A-ULT3-CE SKU are PCI Express 2.0 slots that do not support PCI Express 3.0.
3. If the mSATA module installed on the ECN-360A-ULT3 can not be detected, please set CN8 as an mSATA slot manually in BIOS option (Chipset > PCH-IO Configuration > PCI Express Configuration > Full Size PCIE Mini Card Selection). Please refer to **Section 5.4.2.1**.



**Figure 4-14: Full-size PCIe Mini Card Slot Location**



Pin	Description	Pin	Description
1	PCIE_WAKE#	2	VCC3
3	N/C	4	GND
5	N/C	6	1.5 V
7	VCC3	8	SIM_VCC
9	GND	10	SIM_IO
11	CLK-	12	SIM_CLK
13	CLK+	14	SIM_RST
15	GND	16	SIM_VPP
17	BUF_PLT_RST#	18	GND
19	N/C	20	VCC3
21	GND	22	BUF_PLT_RST#
23	SATA_RXN2_C	24	VCC3
25	SATA_RXP2_C	26	GND
27	GND	28	1.5 V
29	GND	30	SMBCLK
31	SATA_TXN2	32	SMBDATA
33	SATA_TXP2	34	GND
35	GND	36	USB7-
37	GND	38	USB7+
39	VCC3	40	GND
41	VCC3	42	N/C
43	GND	44	RF_LINK#
45	N/C	46	BLUELED#
47	N/C	48	1.5 V
49	N/C	50	GND
51	M-SATADET	52	VCC3

**Table 4-15: Full-size PCIe Mini Card Slot Pinouts**

ECN-360A-ULT3 Embedded System

4.2.14 PCIe Mini Card Slot, Half-size

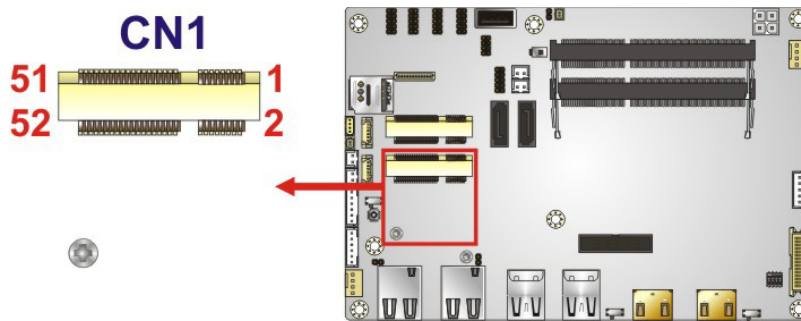
- CN Label: CN1
- CN Type: Half-size PCIe Mini card slot
- CN Location: See **Figure 4-15**
- CN Pinouts: See **Table 4-16**

The PCIe Mini card slot is for installing a half-size PCIe Mini expansion card with USB interface.



**NOTE:**

This half-size PCIe Mini slot on the ECN-360A-ULT3-CE SKU is a PCI Express 2.0 slot, and it does not support USB 2.0 signal.



**Figure 4-15: Half-size PCIe Mini Slot Location**

Pin	Description	Pin	Description
1	PCIE_WAKE#	2	VCC3
3	N/C	4	GND
5	N/C	6	1.5 V
7	VCC3	8	N/C
9	GND	10	N/C
11	CLK_PCIE_MINI2_N	12	N/C
13	CLK_PCIE_MINI2_P	14	N/C
15	GND	16	N/C

Pin	Description	Pin	Description
17	BUF_PLT_RST#	18	GND
19	N/C	20	VCC3
21	GND	22	BUF_PLT_RST#
23	PCIE_RX4DN	24	VCC3
25	PCIE_RX4DP	26	GND
27	GND	28	1.5V
29	GND	30	SMBCLK
31	PCIE_TX4DN	32	SMBDATA
33	PCIE_TX4DP	34	GND
35	GND	36	USB D8-
37	GND	38	USB D8+
39	VCC3	40	GND
41	VCC3	42	N/C
43	GND	44	RF_LINK#
45	N/C	46	BLUELED#
47	N/C	48	1.5 V
49	N/C	50	GND
51	N/C	52	VCC3

**Table 4-16: Half-size PCIe Mini Slot Pinouts**

#### 4.2.15 Power Button

- CN Label: PWR\_SW1
- CN Type: Push button
- CN Location: See **Figure 4-16**

The on-board power button controls system power.

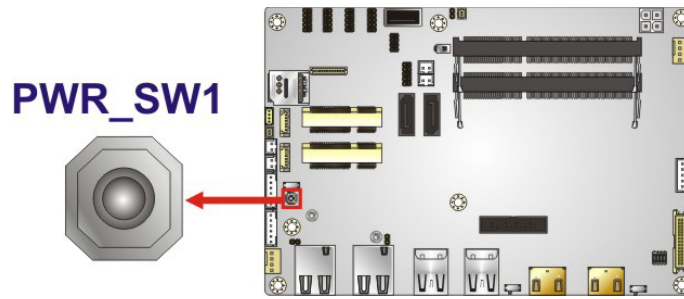


Figure 4-16: Power Button Location

#### 4.2.16 Power Button Connector

- CN Label: PWR\_BTN1
- CN Type: 2-pin wafer, p=2.00 mm
- CN Location: See **Figure 4-17**
- CN Pinouts: See **Table 4-17**

The power button connector is connected to a power switch on the system chassis to enable users to turn the system on and off.

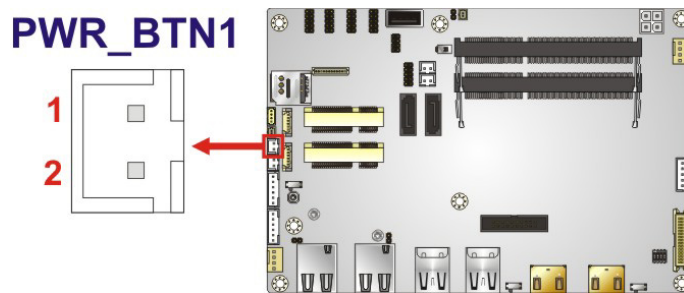


Figure 4-17: Power Button Connector Location

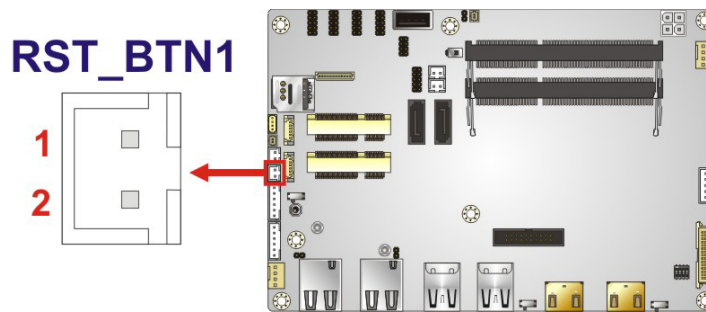
Pin	Description
1	PWR_BTN+
2	PWR_BTN-

Table 4-17: Power Button Connector Pinouts

#### 4.2.17 Reset Button Connector

- CN Label: RST\_BTN1
- CN Type: 2-pin wafer, p=2.00 mm
- CN Location: See **Figure 4-18**
- CN Pinouts: See **Table 4-18**

The reset button connector is connected to a reset switch on the system chassis to enable users to reboot the system when the system is turned on.



**Figure 4-18: Reset Button Connector Location**

Pin	Description
1	RESET+
2	RESET-

**Table 4-18: Reset Button Connector Pinouts**

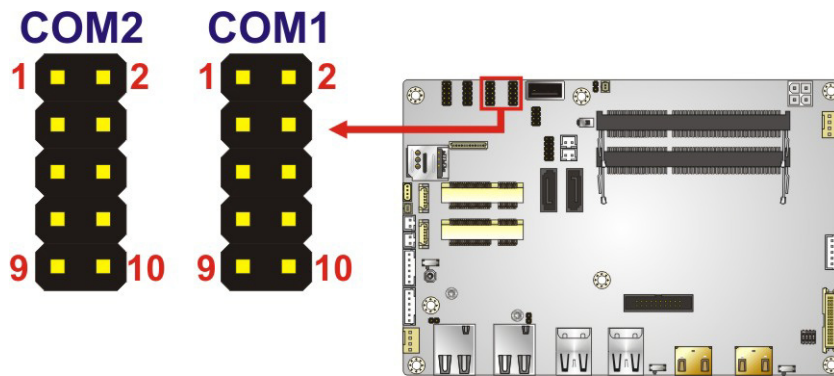


ECN-360A-ULT3 Embedded System

4.2.18 RS-232 Serial Port Connectors

- CN Label: COM1, COM2
- CN Type: 10-pin header, p=2.00 mm
- CN Location: See **Figure 4-19**
- CN Pinouts: See **Table 4-19**

The serial connector provides RS-232 connection.



**Figure 4-19: RS-232 Serial Port Connector Locations**

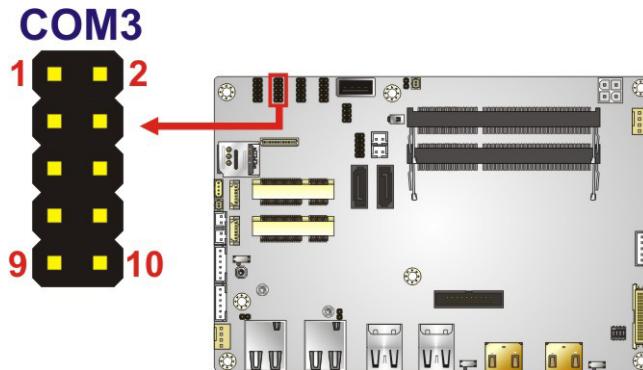
PIN NO.	DESCRIPTION	PIN NO.	DESCRIPTION
1	DCD	2	DSR
3	SIN	4	RTS
5	SOUT	6	CTS
7	DTR	8	RI
9	GND	10	GND

**Table 4-19: RS-232 Serial Port Connector Pinouts**

4.2.19 RS-232/422/485 Serial Port Connector

- CN Label: COM3
- CN Type: 10-pin header, p=2.00 mm
- CN Location: See **Figure 4-20**
- CN Pinouts: See **Table 4-20**

This connector provides RS-232, RS-422 or RS-485 communications. The default mode is set to RS-232 in BIOS. To configure the connector as RS-422 or RS-485, please refer to **Section 5.3.3.1.3**.



**Figure 4-20: RS-232/422/485 Connector Location**

Pin	RS-232	RS-422	RS-485
1	DCD	TX-	D-
2	DSR		
3	SIN	TX+	D+
4	RTS		
5	SOUT	RX+	
6	CTS		
7	DTR	RX-	
8	RI		
9	GND		
10	GND		

**Table 4-20: RS-232/422/485 Connector Pinouts**

ECN-360A-ULT3 Embedded System

Use the optional RS-422/485 cable to connect to a serial device. The pinouts of the DB-9 connector are listed below.

RS-422 Pinouts	RS-485 Pinouts

Table 4-21: DB-9 RS-422/485 Pinouts

4.2.20 SATA 6Gb/s Drive Connectors

- CN Label: **SATA1, SATA2**
- CN Type: 7-pin SATA connector
- CN Location: See **Figure 4-21**

The SATA 6Gb/s drive connector is connected to a SATA 6Gb/s drive. The SATA 6Gb/s drive transfers data at speeds as high as 6Gb/s.

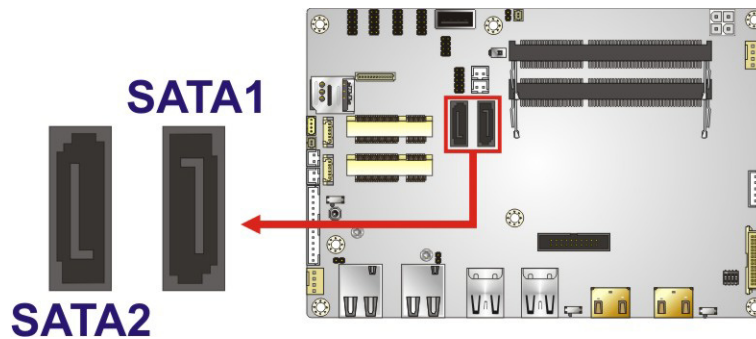


Figure 4-21: SATA 6Gb/s Drive Connectors Locations

#### 4.2.21 SATA Power Connectors

CN Label: **SATA\_PWR1, SATA\_PWR2**

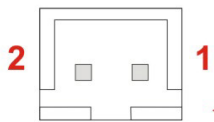
CN Type: 2-pin wafer, p=2.00 mm

CN Location: See **Figure 4-22**

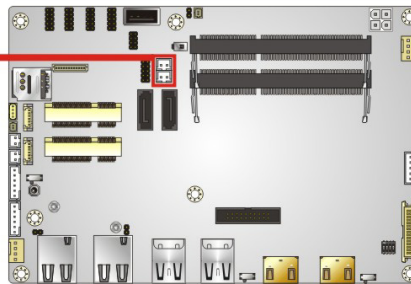
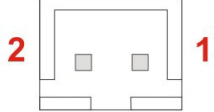
CN Pinouts: See **Table 4-22**

The SATA power connector provides +5 V power output to the SATA connector.

#### SATA\_PWR1



#### SATA\_PWR2



**Figure 4-22: SATA Power Connector Locations**

Pin	Description
1	+5V
2	GND

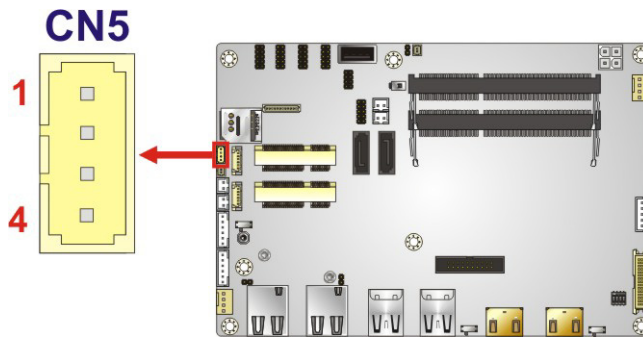
**Table 4-22: SATA Power Connector Pinouts**

ECN-360A-ULT3 Embedded System

4.2.22 SMBus Connector

- CN Label: CN5
- CN Type: 4-pin wafer, p=1.25 mm
- CN Location: See **Figure 4-23**
- CN Pinouts: See **Table 4-23**

The SMBus (System Management Bus) connector provides low-speed system management communications.



**Figure 4-23: SMBus Connector Location**

Pin	Description
1	GND
2	SMB_DATA
3	SMB_CLK
4	+5V

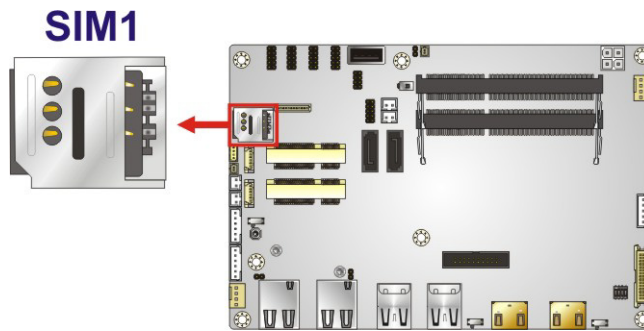
**Table 4-23: SMBus Connector Pinouts**



#### 4.2.23 SIM Card Slot

- CN Label: SIM1
- CN Type: SIM card slot
- CN Location: See **Figure 4-24**

The SIM card slot accepts a SIM card for 3G network communication.



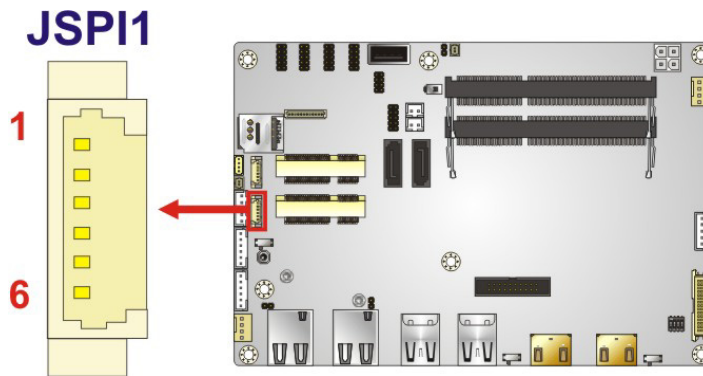
**Figure 4-24: SIM Card Slot Location**

ECN-360A-ULT3 Embedded System

4.2.24 SPI Flash Connector, BIOS

- CN Label: JSPI1
- CN Type: 6-pin wafer, p=1.25 mm
- CN Location: See **Figure 4-25**
- CN Pinouts: See **Table 4-24**

The 6-pin SPI Flash connector is used to flash the BIOS.



**Figure 4-25: SPI Flash Connector Location**

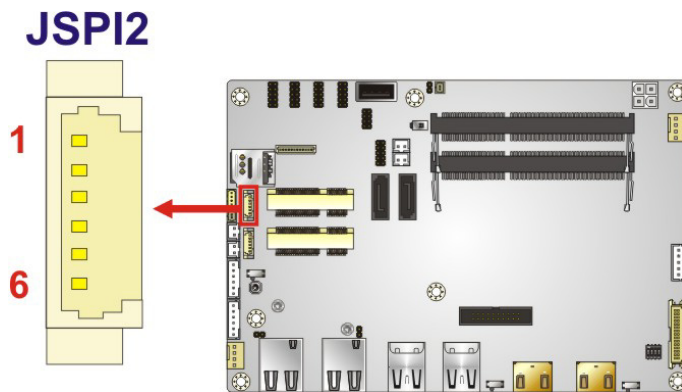
Pin	Description
1	+3.3VA
2	SPI_CS
3	SPI_SO_SW
4	SPI_CLK_SW
5	SPI_SI_SW
6	GND

**Table 4-24: SPI Flash Connector Pinouts**

#### 4.2.25 SPI Flash Connector, EC

- CN Label: J SPI2
- CN Type: 6-pin wafer, p=1.25 mm
- CN Location: See **Figure 4-26**
- CN Pinouts: See **Table 4-25**

The 6-pin SPI Flash connector is used to flash the embedded controller.



**Figure 4-26: SPI Flash Connector Location**

Pin	Description
1	+3.3VA
2	SPI_CS#0_CN_EC
3	SPI_SO_SW_EC
4	SPI_CLK_SW_EC
5	SPI_SI_SW_EC
6	GND

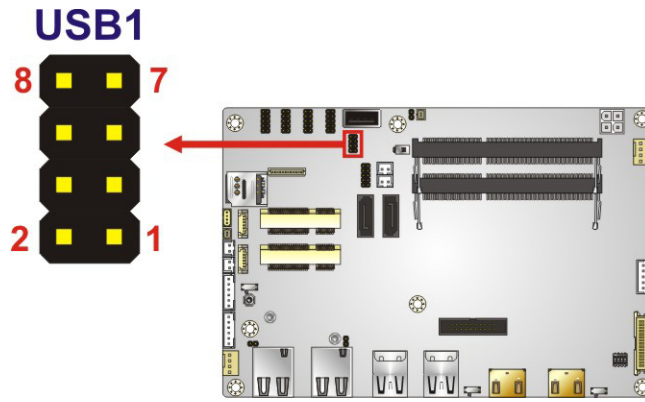
**Table 4-25: SPI Flash Connector Pinouts**

ECN-360A-ULT3 Embedded System

4.2.26 USB Connector

- CN Label: **USB1**
- CN Type: 8-pin header, p=2.00 mm
- CN Location: See **Figure 4-27**
- CN Pinouts: See **Table 4-26**

The USB connector provides two USB 2.0 ports by dual-port USB cable.



**Figure 4-27: USB Connector Location**

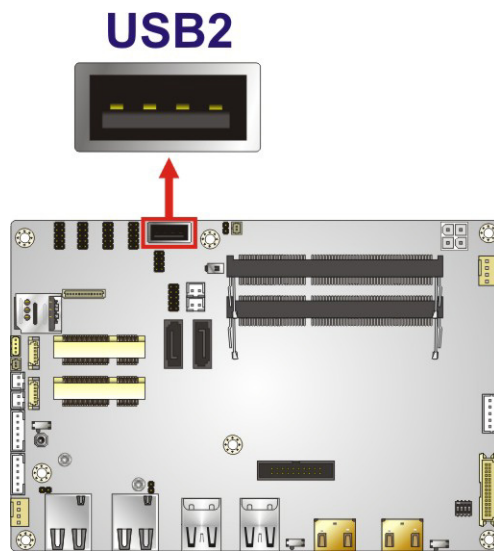
PIN NO.	DESCRIPTION	PIN NO.	DESCRIPTION
1	VCC	2	GND
3	DATA4-	4	DATA5+
5	DATA4+	6	DATA5-
7	GND	8	VCC

**Table 4-26: USB Connector Pinouts**

#### 4.2.27 USB Connector, Type A

- CN Label: **USB2**
- CN Type: USB Type A
- CN Location: See **Figure 4-27**
- CN Pinouts: See **Table 4-26**

The USB connector can be connected to USB 2.0 devices.



**Figure 4-28: USB Connector Location (Type A)**

Pin	Description
1	VCC
2	DATA6+
3	DATA6-
4	GND

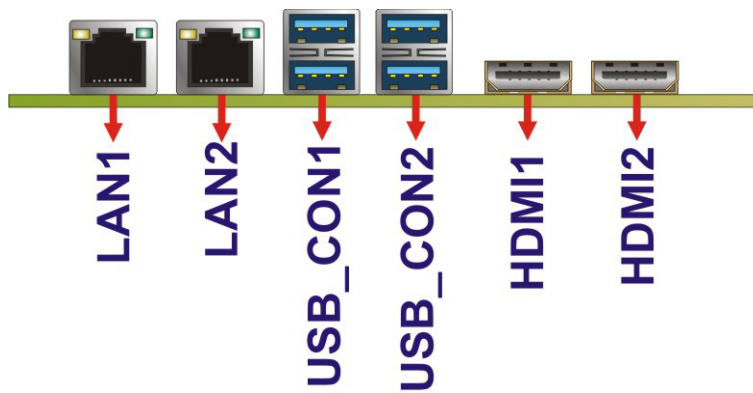
**Table 4-27: USB Connector Pinouts (Type A)**



### 4.3 External Peripheral Interface Connector Panel

**Figure 4-29** shows the ECN-360A-ULT3 external peripheral interface connector (EPIC) panel. The EPIC panel consists of the following:

- 2 x GbE connector
- 2 x HDMI connector
- 4 x USB 3.0 connector



**Figure 4-29: External Peripheral Interface Connector**

#### 4.3.1 HDMI Connectors

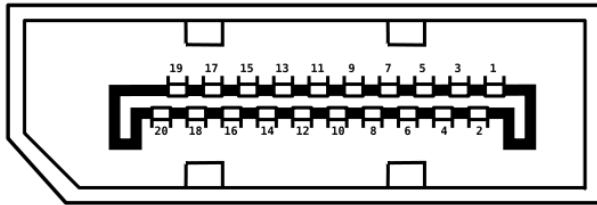
- CN Label: HDMI1, HDMI2  
 CN Type: HDMI connector  
 CN Location: See **Figure 4-29**  
 CN Pinouts: See **Table 4-28**

The HDMI connectors can connect to HDMI devices.

Pin	Description	Pin	Description
1	HDMI_DATA2	2	GND
3	HDMI_DATA2#	4	HDMI_DATA1
5	GND	6	HDMI_DATA1#
7	HDMI_DATA0	8	GND
9	HDMI_DATA0#	10	HDMI_CLK
11	GND	12	HDMI_CLK#

Pin	Description	Pin	Description
13	N/C	14	N/C
15	HDMI_SCL	16	HDMI_SDA
17	GND	18	+5V
19	HDMI_HPD	20	HDMI_GND
21	HDMI_GND	22	HDMI_GND
23	HDMI_GND		

**Table 4-28: HDMI Connector Pinouts**



**Figure 4-30: HDMI Connector Pinout Locations**



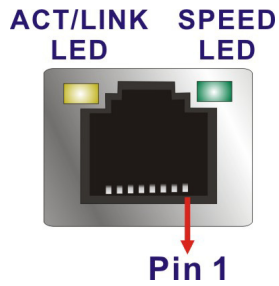
**NOTE:**

The HDMI1 connector is co-lay with the iDP connector. When the iDP connector is enabled, the HDMI1 connector will be disabled. This is controlled by the HDMI/DP select switch. Please refer to **Section 4.4.4** for detailed information.

### 4.3.2 LAN Connectors

- CN Label: LAN1, LAN2
- CN Type: RJ-45
- CN Location: See **Figure 4-29**
- CN Pinouts: See **Figure 3-10** and **Table 4-29**

The LAN connector connects to a local network.



**Figure 4-31: LAN Connector**

Pin	Description	Pin	Description
1	TRD0+	5	TRD2+
2	TRD0-	6	TRD2-
3	TRD1+	7	TRD3+
4	TRD1-	8	TRD3-

**Table 4-29: LAN Pinouts**

### 4.3.3 USB Connectors

CN Label: USB\_CON1, USB\_CON2

CN Type: USB 3.0 port

CN Location: See **Figure 4-29**

CN Pinouts: See **Table 4-30**

The ECN-360A-ULT3 has four external USB 3.0 ports. The USB connector can be connected to a USB 2.0 or USB 3.0 device. The pinouts of USB 3.0 connectors are shown below.

Pin	Description	Pin	Description
1	+5V	2	USB2P0-
3	USB2P0+	4	GND
5	USB3P0_RXDN1	6	USB3P0_RXDP1
7	GND	8	USB3P0_TXDN1
9	USB3P0_TXDP1		

**Table 4-30: USB 3.0 Port Pinouts**

## 4.4 System Configuration

The system configuration is controlled by buttons, jumpers and switches. The system configuration should be performed before installation.

### 4.4.1 AT/ATX Mode Select Switch

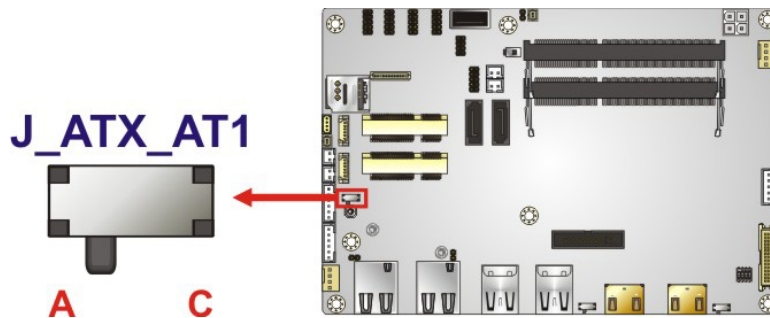
CN Label:	<b>J_ATX_AT1</b>
CN Type:	Switch
CN Location:	See <b>Figure 4-32</b>
CN Settings:	See <b>Table 4-31</b>

The AT/ATX mode select switch specifies the systems power mode as AT or ATX. AT/ATX mode select switch settings are shown in **Table 4-31**.

Setting	Description
Short A-B	ATX Mode (Default)
Short B-C	AT Mode

**Table 4-31: AT/ATX Mode Select Switch Settings**

The location of the AT/ATX mode select switch is shown in **Figure 4-32** below.



**Figure 4-32: AT/ATX Mode Select Switch Location**

### 4.4.2 Clear CMOS Button

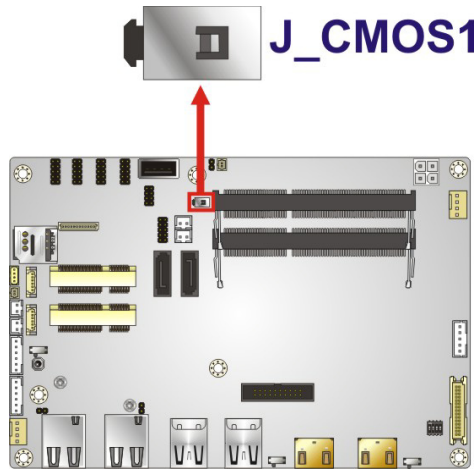
CN Label:	J_CMOS 1
CN Type:	Button

ECN-360A-ULT3 Embedded System

CN Location: See **Figure 4-33**

If the ECN-360A-ULT3 fails to boot due to improper BIOS settings, use the button to clear the CMOS data and reset the system BIOS information.

The location of the clear CMOS button is shown in **Figure 4-33**



**Figure 4-33: Clear CMOS Button Location**

4.4.3 Flash Descriptor Security Override Jumper

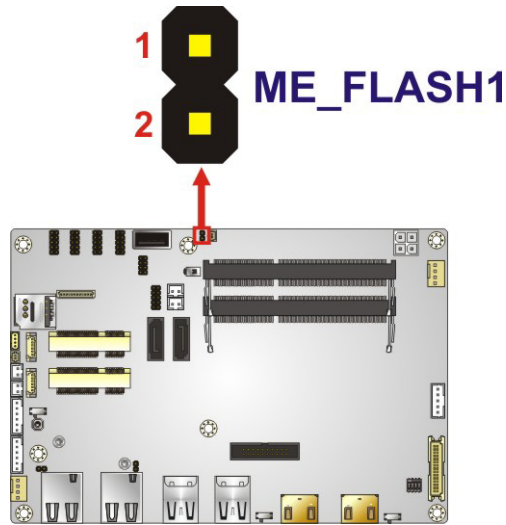
CN Label: **ME\_FLASH1**  
 CN Type: 2-pin header, p=2.00 mm  
 CN Location: See **Figure 4-34**  
 CN Settings: See **Table 4-32**

The Flash Descriptor Security Override jumper (ME\_FLASH1) allows to enable or disable the ME firmware update. Refer to **Figure 4-34** and **Table 4-32** for the jumper location and settings.

Setting	Description
Open	Disabled (default)
Short	Enabled

**Table 4-32: Flash Descriptor Security Override Jumper Settings**





**Figure 4-34: Flash Descriptor Security Override Jumper Location**

To update the ME firmware, please follow the steps below.

- Step 1:** Before turning on the system power, short the Flash Descriptor Security Override jumper.
- Step 2:** Update the BIOS and ME firmware, and then turn off the system power.
- Step 3:** Remove the metal clip on the Flash Descriptor Security Override jumper to its default setting.
- Step 4:** Restart the system. The system will reboot 2 ~ 3 times to complete the ME firmware update.

#### 4.4.4 HDMI/DP Select Switch

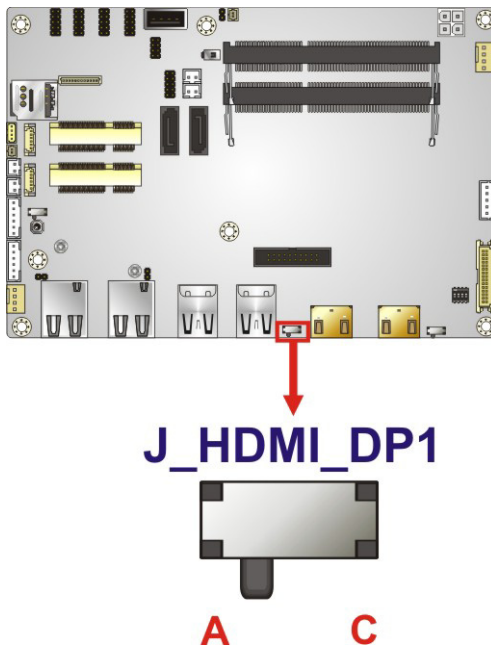
CN Label:	<b>J_HDMI_DP1</b>
CN Type:	Switch
CN Location:	See <b>Figure 4-35</b>
CN Settings:	See <b>Table 4-33</b>

Use the HDMI/DP select switch to disable or enable the HDMI1 connector since the iDP connector (DP1) is co-lay with the HDMI1 connector. HDMI/DP select switch settings are shown in **Table 4-33**.

Setting	Description
Short A-B	Enable HDMI1 and disable DisplayPort (DP1) (Default)
Short B-C	Disable HDMI1 and enable DisplayPort (DP1)

**Table 4-33: HDMI/DP Select Switch Settings**

The location of the HDMI/DP select switch is shown in **Figure 4-32** below.



**Figure 4-35: HDMI/DP Select Switch Location**

#### 4.4.5 LVDS Panel Resolution Select Switch

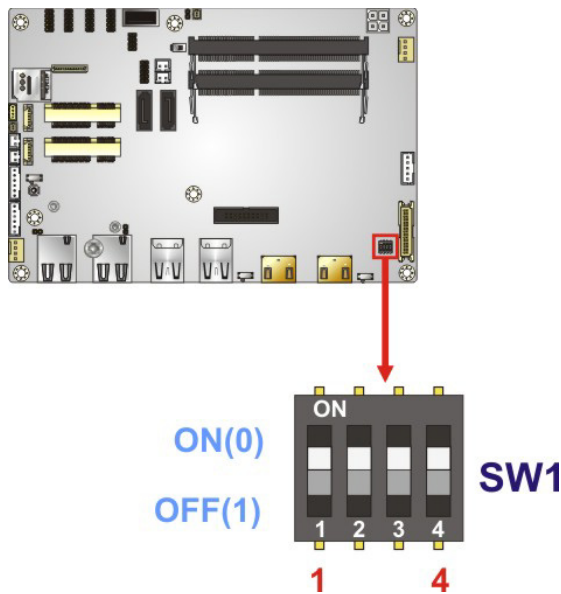
- Jumper Label: SW1
- Jumper Type: DIP switch
- Jumper Settings: See **Table 4-34**
- Jumper Location: See **Figure 4-36**

Selects the resolution of the LCD panel connected to the LVDS connector.

\* ON=0, OFF=1; Single=S, Dual=D

SW1 (4-3-2-1)	Description
0000	800x600 18-bit S (default)
0001	1024x768 18-bit S
0010	1024x768 24-bit S
0011	1280x768 18-bit S
0100	1280x800 18-bit S
0101	1280x960 18-bit S
0110	1280x1024 24-bit D
0111	1366x768 18-bit S
1000	1366x768 24-bit S
1001	1440x960 24-bit D
1010	1400x1050 24-bit D
1011	1600x900 24-bit D
1100	1680x1050 24-bit D
1101	1600x1200 24-bit D
1110	1920x1080 24-bit D
1111	1920x1200 24-bit D

**Table 4-34: LVDS Panel Resolution Selection**



**Figure 4-36: LVDS Panel Resolution Select Switch Location**

4.4.6 LVDS Voltage Select Jumper



**WARNING:**

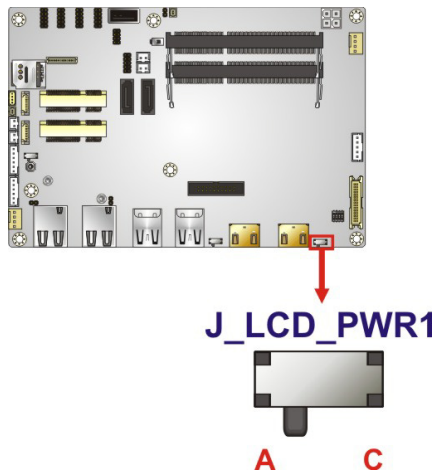
Permanent damage to the screen and ECN-360A-ULT3 may occur if the wrong voltage is selected with this jumper. Please refer to the user guide that came with the monitor to select the correct voltage.

- Jumper Label: **J\_LCD\_PWR1**
- Jumper Type: Switch
- Jumper Settings: See **Table 4-35**
- Jumper Location: See **Figure 4-37**

The LVDS voltage select switch allows setting the voltage provided to the monitor connected to the LVDS connector. The LVDS voltage select switch settings are shown in **Table 4-31**.

Setting	Description
Short A-B	+3.3 V (Default)
Short B-C	+5

**Table 4-35: LVDS Voltage Select Jumper Settings**



**Figure 4-37: LVDS Voltage Select Jumper Location**

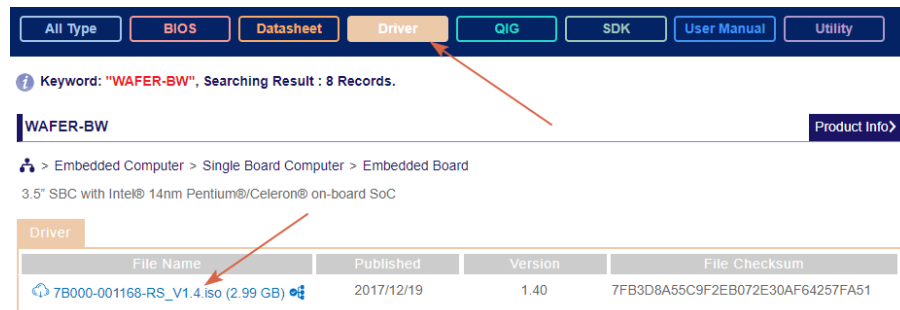
## 4.5 Driver Download

To download drivers from IEI Resource Download Center, follow the steps below.

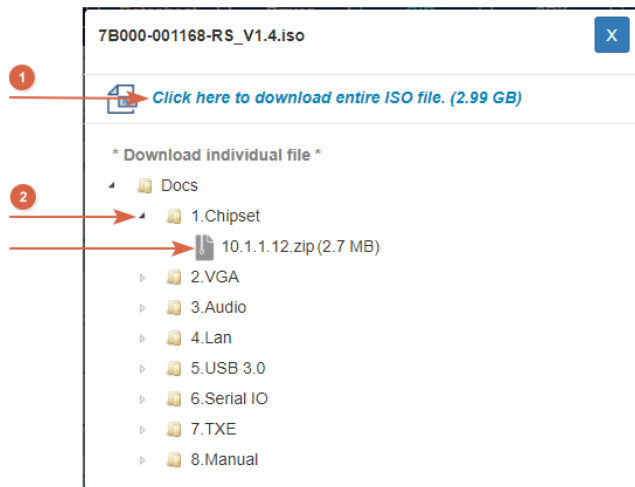
**Step 1:** Go to <https://download.ieiworld.com>. Type ECN-360A-ULT3 and press Enter.



**Step 2:** All product-related software, utilities, and documentation will be listed. You can choose **Driver** to filter the result.



**Step 3:** Click the driver file name on the page and you will be prompted with the following window. You can download the entire ISO file (❶), or click the small arrow to find an individual driver and click the file name to download (❷).







**NOTE:**

To install software from the downloaded ISO image file in Windows 8, 8.1 or 10, double-click the ISO file to mount it as a virtual drive to view its content. On Windows 7 system, an additional tool (such as Virtual CD-ROM Control Panel from Microsoft) is needed to mount the file.

---

Chapter

5

**BIOS**

---

## 5.1 Introduction

The BIOS is programmed onto the BIOS chip. The BIOS setup program allows changes to certain system settings. This chapter outlines the options that can be changed.



### NOTE:

Some of the BIOS options may vary throughout the life cycle of the product and are subject to change without prior notice.

### 5.1.1 Starting Setup

The UEFI BIOS is activated when the computer is turned on. The setup program can be activated in one of two ways.

1. Press the **DELETE** or **F2** key as soon as the system is turned on or
2. Press the **DELETE** or **F2** key when the “**Press Del to enter SETUP**” message appears on the screen.

If the message disappears before the **DELETE** or **F2** key is pressed, restart the computer and try again.

### 5.1.2 Using Setup

Use the arrow keys to highlight items, press **ENTER** to select, use the PageUp and PageDown keys to change entries, press **F1** for help and press **Esc** to quit. Navigation keys are shown in.

Key	Function
Up arrow	Move to previous item
Down arrow	Move to next item
Left arrow	Move to the item on the left hand side
Right arrow	Move to the item on the right hand side
+	Increase the numeric value or make changes

Key	Function
-	Decrease the numeric value or make changes
F1 key	General help, only for Status Page Setup Menu and Option Page Setup Menu
F2 key	Load previous values.
F3 key	Load optimized defaults
F4 key	Save changes and Exit BIOS
Esc key	Main Menu – Quit and not save changes into CMOS Status Page Setup Menu and Option Page Setup Menu -- Exit current page and return to Main Menu

### 5.1.3 Getting Help

When **F1** is pressed a small help window describing the appropriate keys to use and the possible selections for the highlighted item appears. To exit the Help Window press **Esc** or the **F1** key again.

### 5.1.4 Unable to Reboot after Configuration Changes

If the computer cannot boot after changes to the system configuration is made, CMOS defaults. Use the jumper described in **Section 4.4.2**.

### 5.1.5 BIOS Menu Bar

The **menu bar** on top of the BIOS screen has the following main items:

- Main – Changes the basic system configuration.
- Advanced – Changes the advanced system settings.
- Chipset – Changes the chipset settings.
- Security – Sets User and Supervisor Passwords.
- Boot – Changes the system boot configuration.
- Save & Exit – Selects exit options and loads default settings

The following sections completely describe the configuration options found in the menu items at the top of the BIOS screen and listed above.

## ECN-360A-ULT3 Embedded System

### 5.2 Main

The **Main** BIOS menu (**BIOS Menu 1**) appears when the **BIOS Setup** program is entered.

```

Aptio Setup Utility - Copyright (C) 2017 American Megatrends, Inc.
  Main  Advanced  Chipset  Security  Boot  Save & Exit
BIOS Information
BIOS Vendor                American Megatrends
Core Version                5.11
Compliancy                 UEFI 2.4; PI 1.3
Project Version            B361AR17.ROM
Build Date and Time       03/14/2017 15:22:00

iWDD Vendor                iEi
iWDD Version               B361ER15.bin
Access Level               Administrator

Processor Information
Name                       SkyLake
Brand String               Intel(R) Core(TM)
                           i5-6300U CPU @ 2.40GHz
Frequency                  2300 MHz
Processor ID                406E3
Stepping                   D0/K0
Number of Processors       2Core(s) / 4Thread(s)
Microcode Revision         7C
GT Info                     GT2

IGFX VBIOS Version         1040
Memory RC Version          1.9.0.0
Total Memory                4096 MB
Memoery Frequency          2133 MHz

PCH Information
Name                       SKL PCH-LP
PCH SKU                     PCH-LP Mobile (U)
                           Premium SKU
Stepping                    21/C1
LAN PHY Revision           B2

ME FW Version               11.0.0.1202
ME Firmware SKU             Corporate SKU

SPI Clock Frequency
D0FR Support                Unsupported
Read Status Clock Frequency 17 MHz
Write Status Clock Frequency 17 MHz
Fast Read Status Clock Frequency 17 MHz

System Date                 [Fri 10/27/2017]
System Time                 [10:18:35]

Version 2.17.1255. Copyright (C) 2017 American Megatrends, Inc.
-----
<->: Select Screen
↑ ↓: Select Item
Enter>Select
+/-: Change Opt.
F1: General Help
F2: Previous Values
F3: Optimized Defaults
F4: Save & Exit
ESC: Exit
  
```

**BIOS Menu 1: Main**



The System Overview field also has two user configurable fields:

→ System Date [xx/xx/xx]

Use the **System Date** option to set the system date. Manually enter the day, month and year.

→ System Time [xx:xx:xx]

Use the **System Time** option to set the system time. Manually enter the hours, minutes and seconds.

### 5.3 Advanced

Use the **Advanced** menu (**BIOS Menu 2**) to configure the CPU and peripheral devices through the following sub-menus:



#### WARNING!

Setting the wrong values in the sections below may cause the system to malfunction. Make sure that the settings made are compatible with the hardware.

```

Aptio Setup Utility - Copyright (C) 2017 American Megatrends, Inc.
Main  Advanced  Chipset  Security  Boot  Save & Exit
-----
> ACPI Settings
> AMT Configuration
> F81866 Super IO Configuration
> iWDD H/W Monitor
> RTC Wake Settings
> Serial Port Console Redirection
> CPU Configuration
> SATA Configuration
> USB Configuration
> iEi Feature

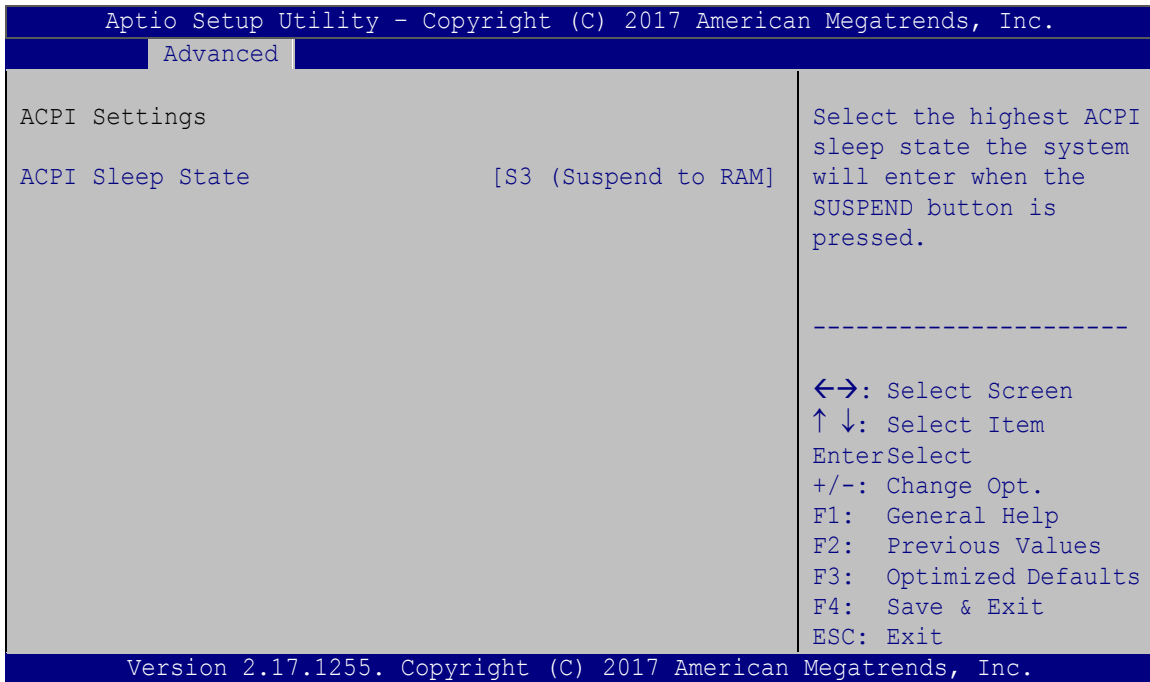
System ACPI Parameters.
-----
<=>: Select Screen
↑ ↓: Select Item
Enter>Select
F1  General Help
F2  Previous Values
F3  Optimized Defaults
F4  Save
ESC Exit

Version 2.17.1255. Copyright (C) 2017 American Megatrends, Inc.
    
```

#### BIOS Menu 2: Advanced

### 5.3.1 ACPI Settings

The **ACPI Settings** menu (**BIOS Menu 3**) configures the Advanced Configuration and Power Interface (ACPI) options.



#### BIOS Menu 3: ACPI Settings

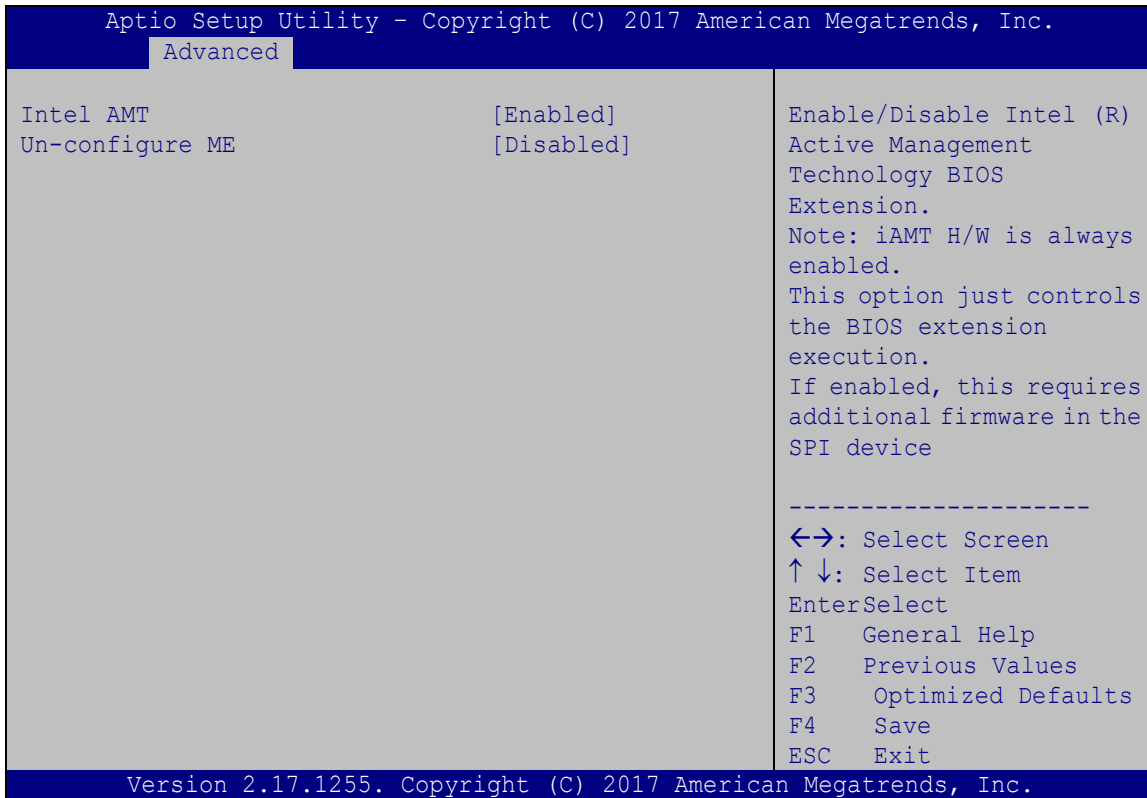
➔ **ACPI Sleep State [S3 (Suspend to RAM)]**

Use the **ACPI Sleep State** option to specify the sleep state the system enters when it is not being used.

- ➔ **S3 (Suspend to DEFAULT RAM)** The caches are flushed and the CPU is powered off. Power to the RAM is maintained. The computer returns slower to a working state, but more power is saved.

### 5.3.2 AMT Configuration

The **AMT Configuration** menu (**BIOS Menu 4**) allows Intel® Active Management Technology (AMT) options to be configured.



#### BIOS Menu 4: AMT Configuration

→ Intel AMT [Enabled]

Use **Intel AMT** option to enable or disable the Intel® AMT function.

- **Disabled** Intel® AMT is disabled
- **Enabled** **DEFAULT** Intel® AMT is enabled

→ Un-configure ME [Disabled]

Use the **Un-configure ME** option to perform ME unconfigure without password operation.

- **Disabled** **DEFAULT** Not perform ME unconfigure

## ECN-360A-ULT3 Embedded System

➔ **Enabled** To perform ME unconfigure

### 5.3.3 F81866 Super IO Configuration

Use the **F81866 Super IO Configuration** menu (**BIOS Menu 5**) to set or change the configurations for the serial ports.

```

Aptio Setup Utility - Copyright (C) 2017 American Megatrends, Inc.
  Advanced
F81866 Super IO Configuration
Super IO Chip                F81866
> Serial Port 1 Configuration
> Serial Port 2 Configuration
> Serial Port 3 Configuration

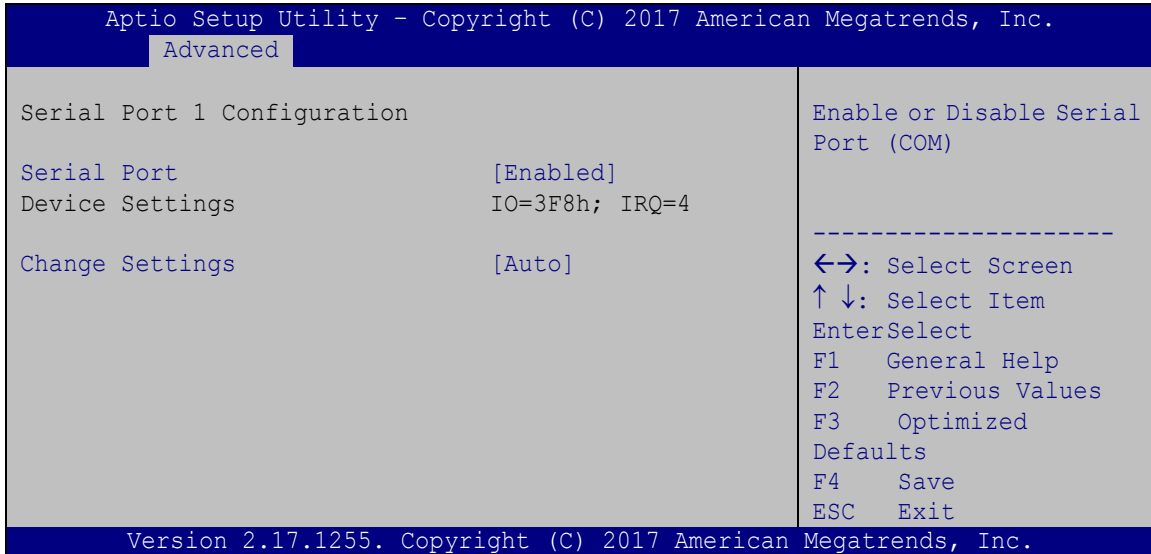
Set Parameters of Serial
Port 1 (COMA)
-----
<=>: Select Screen
↑↓: Select Item
EnterSelect
F1  General Help
F2  Previous Values
F3  Optimized
Defaults
F4  Save
ESC Exit

Version 2.17.1255. Copyright (C) 2017 American Megatrends, Inc.
  
```

#### **BIOS Menu 5: F81866 Super IO Configuration**

### 5.3.3.1 Serial Port n Configuration

Use the **Serial Port n Configuration** menu (**BIOS Menu 6**) to configure the serial port n.



#### BIOS Menu 6: Serial Port n Configuration

##### 5.3.3.1.1 Serial Port 1 Configuration

→ Serial Port [Enabled]

Use the **Serial Port** option to enable or disable the serial port.

- **Disabled**                      Disable the serial port
- **Enabled**            **DEFAULT**      Enable the serial port

→ Change Settings [Auto]

Use the **Change Settings** option to change the serial port IO port address and interrupt address.

- **Auto**                      **DEFAULT**      The serial port IO port address and interrupt address are automatically detected.
- **IO=3F8h; IRQ=4**                      Serial Port I/O port address is 3F8h and the interrupt address is IRQ4



## ECN-360A-ULT3 Embedded System

- ➔ **IO=3F8h; IRQ=3, 4,5,6,7,9,10,11,12**      Serial Port I/O port address is 3F8h and the interrupt address is IRQ3,4,5,6,7,9,10,11,12
- ➔ **IO=2F8h; IRQ=3, 4,5,6,7,9,10,11,12**      Serial Port I/O port address is 2F8h and the interrupt address is IRQ3,4,5,6,7,9,10,11,12
- ➔ **IO=3E8h; IRQ=3, 4,5,6,7,9,10,11,12**      Serial Port I/O port address is 3E8h and the interrupt address is IRQ3,4,5,6,7,9,10,11,12
- ➔ **IO=2E8h; IRQ=3, 4,5,6,7,9,10,11,12**      Serial Port I/O port address is 2E8h and the interrupt address is IRQ3,4,5,6,7,9,10,11,12

### 5.3.3.1.2 Serial Port 2 Configuration

#### ➔ Serial Port [Enabled]

Use the **Serial Port** option to enable or disable the serial port.

- ➔ **Disabled**      Disable the serial port
- ➔ **Enabled      DEFAULT**      Enable the serial port

#### ➔ Change Settings [Auto]

Use the **Change Settings** option to change the serial port IO port address and interrupt address.

- ➔ **Auto      DEFAULT**      The serial port IO port address and interrupt address are automatically detected.
- ➔ **IO=2F8h; IRQ=3**      Serial Port I/O port address is 2F8h and the interrupt address is IRQ3
- ➔ **IO=3F8h; IRQ=3, 4,5,6,7,9,10,11,12**      Serial Port I/O port address is 3F8h and the interrupt address is IRQ3,4,5,6,7,9,10,11,12
- ➔ **IO=2E8h; IRQ=3, 4,5,6,7,9,10,11,12**      Serial Port I/O port address is 2E8h and the interrupt address is IRQ3,4,5,6,7,9,10,11,12
- ➔ **IO=3E8h; IRQ=3, 4,5,6,7,9,10,11,12**      Serial Port I/O port address is 3E8h and the interrupt address is IRQ3,4,5,6,7,9,10,11,12

- ➔ **IO=2E8h; IRQ=3, 4,5,6,7,9,10,11,12**

Serial Port I/O port address is 2E8h and the interrupt address is IRQ3,4,5,6,7,9,10,11,12

### 5.3.3.1.3 Serial Port 3 Configuration

- ➔ Serial Port [Enabled]

Use the **Serial Port** option to enable or disable the serial port.

- ➔ **Disabled**                      Disable the serial port
- ➔ **Enabled**            **DEFAULT**      Enable the serial port

- ➔ Change Settings [Auto]

Use the **Change Settings** option to change the serial port IO port address and interrupt address.

- ➔ **Auto**                      **DEFAULT**              The serial port IO port address and interrupt address are automatically detected.
- ➔ **IO=3E8h; IRQ=11**                      Serial Port I/O port address is 3E8h and the interrupt address is IRQ11
- ➔ **IO=3E8h; IRQ=3, 4,5,6,7,9,10,11,12**                      Serial Port I/O port address is 3E8h and the interrupt address is IRQ3,4,5,6,7,9,10,11,12
- ➔ **IO=2E8h; IRQ=3, 4,5,6,7,9,10,11,12**                      Serial Port I/O port address is 2E8h and the interrupt address is IRQ3,4,5,6,7,9,10,11,12
- ➔ **IO=2F0h; IRQ=3, 4,5,6,7,9,10,11,12**                      Serial Port I/O port address is 2F0h and the interrupt address is IRQ3,4,5,6,7,9,10,11,12
- ➔ **IO=2E0h; IRQ=3, 4,5,6,7,9,10,11,12**                      Serial Port I/O port address is 2E0h and the interrupt address is IRQ3,4,5,6,7,9,10,11,12

## ECN-360A-ULT3 Embedded System

### → Device Mode [RS232]

Use the **Device Mode** option to select the Serial Port 3 signaling mode.

- **RS422**                      Serial Port 3 signaling mode is RS-422
- **RS232**            **DEFAULT**      Serial Port 3 signaling mode is RS-232
- **RS485**                      Serial Port 3 signaling mode is RS-485

### 5.3.4 iWDD H/W Monitor

The **iWDD H/W Monitor** menu (**BIOS Menu 7**) contains the fan configuration submenus and displays operating temperature, fan speeds and system voltages.

```

Aptio Setup Utility - Copyright (C) 2017 American Megatrends, Inc.
-----
Advanced
-----
PC Health Status
CPU temperature           :+31 °C
System temperature       :+24 °C

CPU_FAN1 Speed           :N/A
SYS_FAN1 Speed           :N/A

CPU_CORE                  :+0.880 V
+5V                       :+5.000 V
+12V                      :+12.320 V
+DDR                      :+1.196 V
+5VSB                     :+4.896 V
+3.3V                     :+3.248 V
+3.3VSB                   :+3.288 V

> Smart Fan Mode Configuration

Smart Fan Mode Select

-----
<->: Select Screen
↑↓: Select Item
Enter>Select
+ - Change Opt.
F1  General Help
F2  Previous Values
F3  Optimized Defaults
F4  Save & Exit
ESC Exit
    
```

#### BIOS Menu 7: iWDD H/W Monitor

### → PC Health Status

The following system parameters and values are shown. The system parameters that are monitored are:

- System Temperatures:
  - CPU Temperature

- System temperature
- Fan Speed:
  - CPU Fan Speed
  - System Fan Speed
- Voltages
  - CPU\_CORE
  - +5V
  - +12V
  - +DDR
  - +5VSB
  - +3.3V
  - +3.3VSB

### 5.3.4.1 Smart Fan Mode Configuration

Use the **Smart Fan Mode Configuration** submenu (**BIOS Menu 8**) to configure fan temperature and speed settings.

```

Aptio Setup Utility - Copyright (C) 2017 American Megatrends, Inc.
Advanced
Smart Fan Mode Configuration
CPU_FAN1 Smart Fan Control      [Auto Mode]
Auto mode fan start temperature  50
Auto mode fan off temperature   40
Auto mode fan start PWM          30
Auto mode fan slope PWM         1
SYS_FAN1 Smart Fan Control      [Auto Mode]
Auto mode fan start temperature  50
Auto mode fan off temperature   40
Auto mode fan start PWM          30
Auto mode fan slope PWM         1
Smart Fan Mode Select
-----
<->: Select Screen
↑ ↓: Select Item
EnterSelect
+ - Change Opt.
F1  General Help
F2  Previous Values
F3  Optimized Defaults
F4  Save & Exit
ESC Exit
Version 2.17.1255. Copyright (C) 2017 American Megatrends, Inc.
  
```

#### BIOS Menu 8: Smart Fan Mode Configuration

➔ CPU\_FAN1 Smart Fan Control [Auto Mode]

Use the **CPU\_FAN1 Smart Fan Control** BIOS option to configure the CPU Smart Fan.

## ECN-360A-ULT3 Embedded System

- ➔ **Manual Mode**      **DEFAULT**      The fan spins at the speed set in the Manual Mode option
- ➔ **Auto Mode**      **DEFAULT**      The fan adjusts its speed using these settings:
  - Auto mode fan start temperature
  - Auto mode fan off temperature
  - Auto mode fan start PWM
  - Auto mode fan slope PWM

### ➔ SYS\_FAN1 Smart Fan Control [Auto Mode]

Use the **SYS\_FAN1 Smart Fan Control** BIOS option to configure the system smart fan.

- ➔ **Manual Mode**      The fan spins at the speed set in the Manual Mode option
- ➔ **Auto Mode**      **DEFAULT**      The fan adjusts its speed using these settings:
  - Auto mode fan start temperature
  - Auto mode fan off temperature
  - Auto mode fan start PWM
  - Auto mode fan slope PWM

### ➔ Auto mode fan start temperature [50]



#### **WARNING:**

Setting this value too high may cause the fan to rotate at full speed only when the CPU is at a very high temperature and therefore cause the system to be damaged.

The **Auto mode fan start temperature** option can only be set if the **SYS\_FAN1 Smart Fan Control** option is set to **Auto Mode**. If the system temperature is between **Start Temperature** and **Off Temperature**, the fan speed change to be **Start PWM**. To set a



value, select the **Auto mode fan start temperature** option and enter a decimal number between 1 and 100.

→ Auto mode fan off temperature [40]

---



**WARNING:**

Setting this value too high may cause the fan to speed up only when the CPU is at a very high temperature and therefore cause the system to be damaged.

---

The **Auto mode fan off temperature** option can only be set if the **SYS\_FAN1 Smart Fan control** option is set to **Auto Mode**. If the system temperature is lower than **Auto mode fan off temperature**, the fan speed change to be lowest. To set a value, select the **Auto mode fan off temperature** option and enter a decimal number between 1 and 100.

→ Auto mode fan start PWM [30]

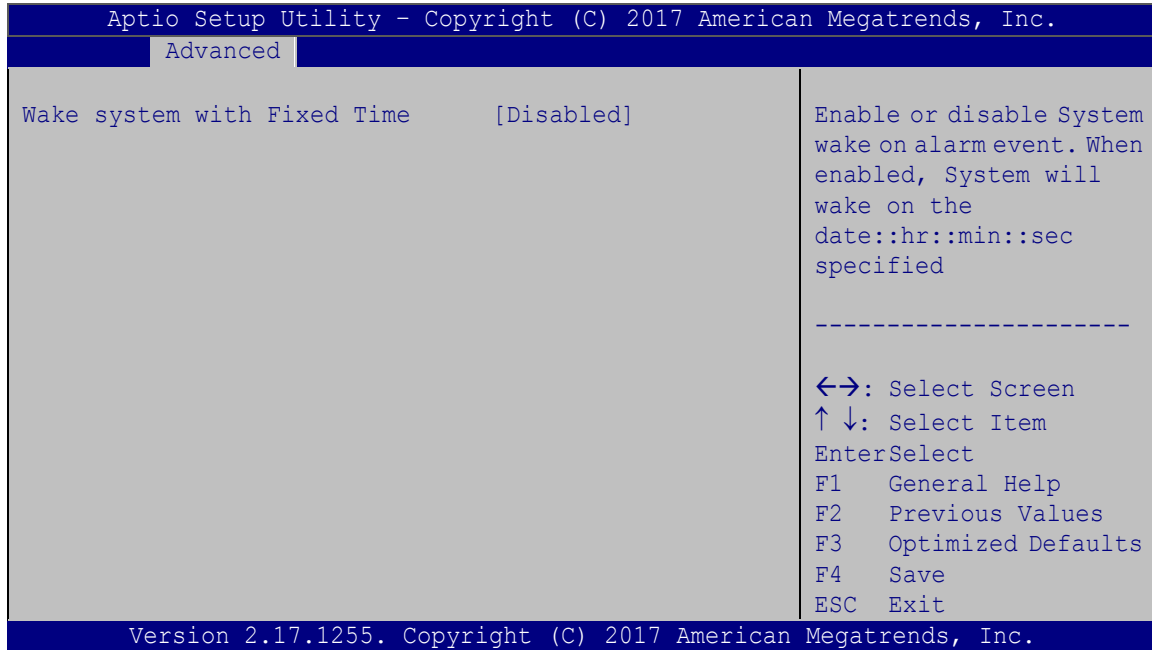
The **Auto mode fan start PWM** option can only be set if the **SYS\_FAN1 Smart Fan control** option is set to **Auto Mode**. Use the **Auto mode fan start PWM** option to set the PWM start value. To set a value, select the **Auto mode fan start PWM** option and enter a decimal number between 1 and 100.

→ Auto mode fan slope PWM [1]

The **Auto mode fan slope PWM** option can only be set if the **SYS\_FAN1 Smart Fan control** option is set to **Auto Mode**. Use the **Auto mode fan slope PWM** option to select the linear rate at which the PWM mode increases with respect to an increase in temperature. To set a value, select the **Auto mode fan slope PWM** option and enter a decimal number between 1 and 64.

### 5.3.5 RTC Wake Settings

The **RTC Wake Settings** menu (**BIOS Menu 9**) configures RTC wake event.



#### BIOS Menu 9: RTC Wake Settings

→ Wake system with Fixed Time [Disabled]

Use the **Wake system with Fixed Time** option to enable or disable the system wake on alarm event.

→ **Disabled**      **DEFAULT**      The real time clock (RTC) cannot generate a wake event

→ **Enabled**      If selected, the **Wake up every day** option appears allowing you to enable to disable the system to wake every day at the specified time. Besides, the following options appear with values that can be selected:

Wake up date

Wake up hour

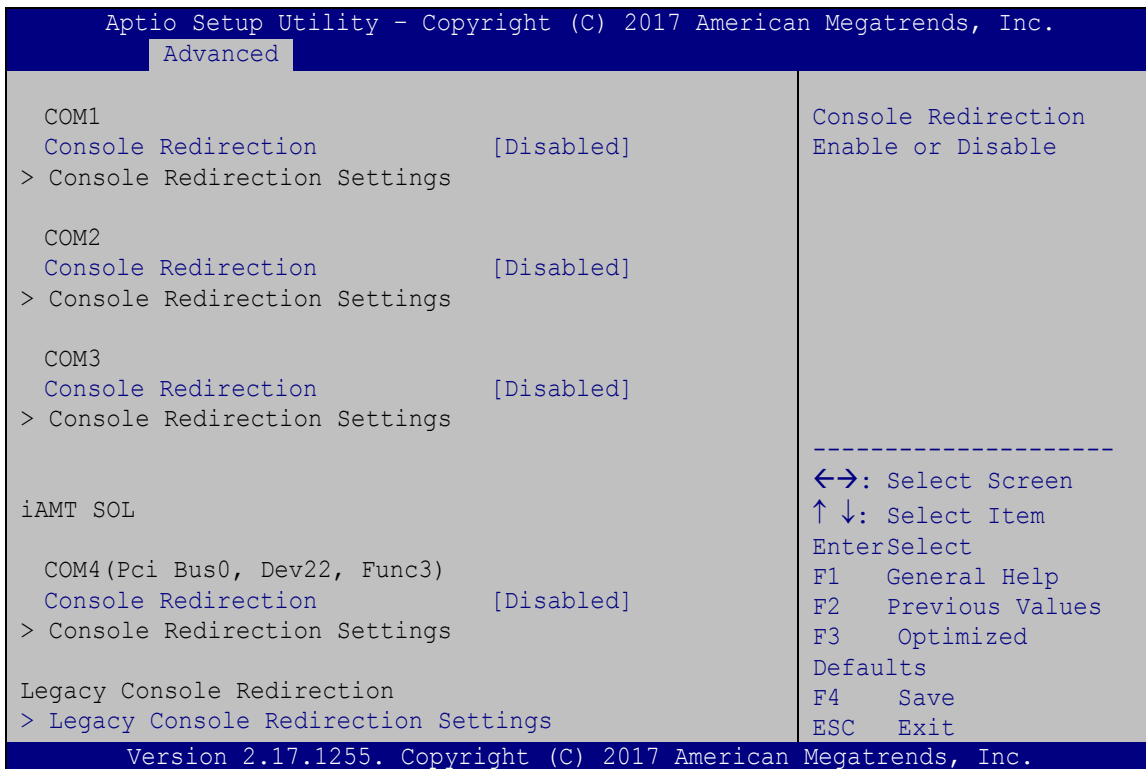
Wake up minute

### Wake up second

After setting the alarm, the computer turns itself on from a suspend state when the alarm goes off.

### 5.3.6 Serial Port Console Redirection

The **Serial Port Console Redirection** menu (**BIOS Menu 10**) allows the console redirection options to be configured. Console redirection allows users to maintain a system remotely by re-directing keyboard input and text output through the serial port.



#### BIOS Menu 10: Serial Port Console Redirection

➔ Console Redirection [Disabled]

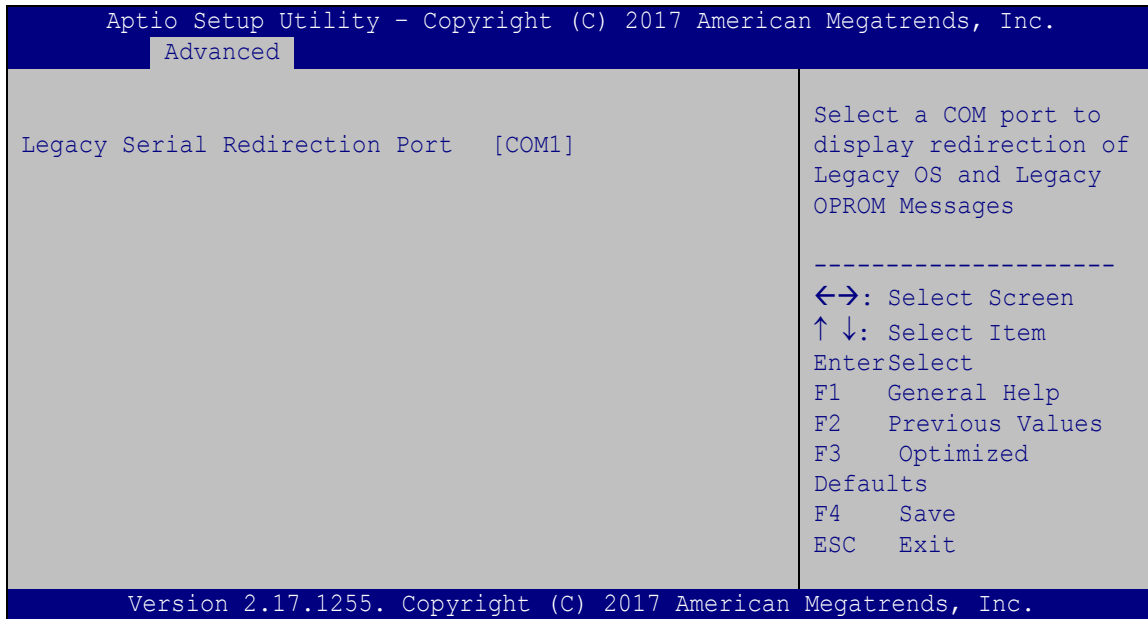
Use **Console Redirection** option to enable or disable the console redirection function.

➔ **Disabled**      **DEFAULT**      Disabled the console redirection function

➔ **Enabled**                      Enabled the console redirection function

### 5.3.6.1 Legacy Console Redirection Settings

The **Legacy Console Redirection Settings** menu (**BIOS Menu 11**) allows the legacy console redirection options to be configured.



#### BIOS Menu 11: Legacy Console Redirection Settings

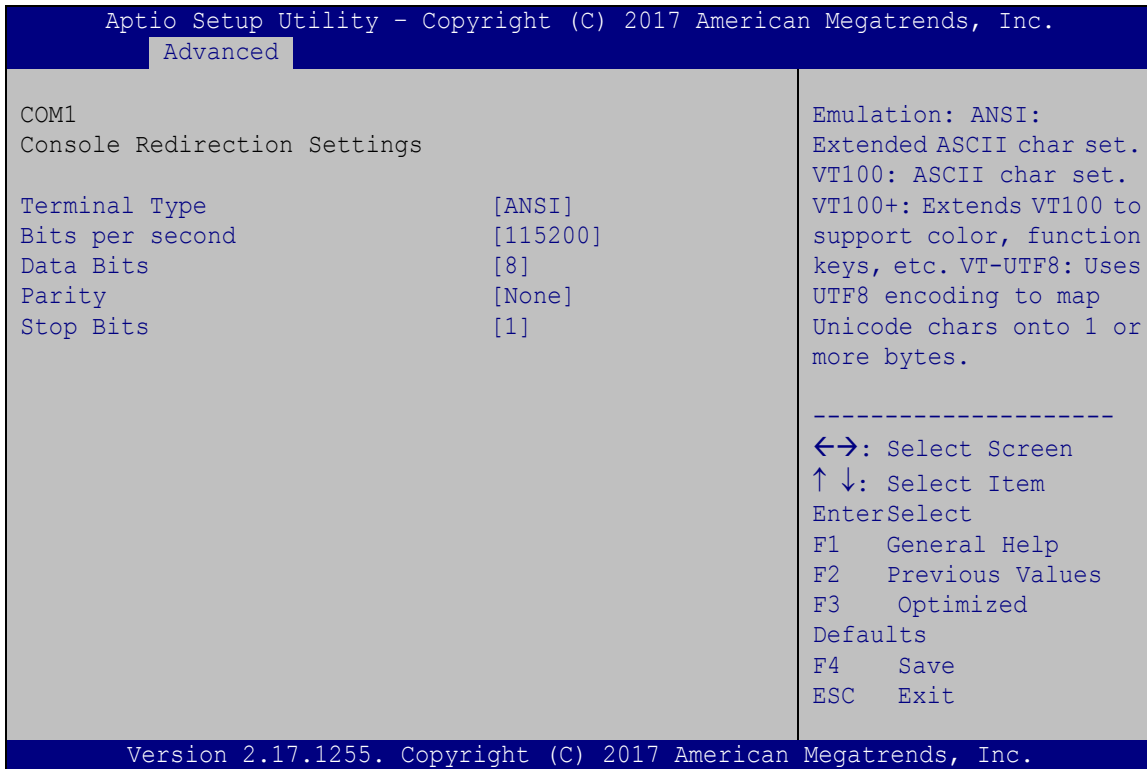
➔ Legacy Serial Redirection Port [COM1]

Use the **Legacy Serial Redirection Port** option to specify a COM port to display redirection of legacy OS and legacy OPROM messages. The options include:

- COM1           **DEFAULT**
- COM2
- COM3
- COM4 (Pci Bus0, Dev22, Func3)

### 5.3.6.2 Console Redirection Settings

The **Console Redirection Settings** menu (**BIOS Menu 12**) allows the console redirection options to be configured. The option is active when Console Redirection option is enabled.



#### BIOS Menu 12: Console Redirection Settings

➔ Terminal Type [ANSI]

Use the **Terminal Type** option to specify the remote terminal type.

- ➔ **VT100**                                      The target terminal type is VT100
- ➔ **VT100+**                                    The target terminal type is VT100+
- ➔ **VT-UTF8**                                    The target terminal type is VT-UTF8
- ➔ **ANSI**                                        **DEFAULT**                                    The target terminal type is ANSI



## ECN-360A-ULT3 Embedded System

## → Bits per second [115200]

Use the **Bits per second** option to specify the serial port transmission speed. The speed must match the other side. Long or noisy lines may require lower speeds.

- |   |               |                |  |
|---|---------------|----------------|--|
| → | <b>9600</b>   |                | Sets the serial port transmission speed at 9600.   |
| → | <b>19200</b>  |                | Sets the serial port transmission speed at 19200.  |
| → | <b>57600</b>  |                | Sets the serial port transmission speed at 57600.  |
| → | <b>115200</b> | <b>DEFAULT</b> | Sets the serial port transmission speed at 115200. |

## → Data Bits [8]

Use the **Data Bits** option to specify the number of data bits.

- |   |          |                |                          |
|---|----------|----------------|--------------------------|
| → | <b>7</b> |                | Sets the data bits at 7. |
| → | <b>8</b> | <b>DEFAULT</b> | Sets the data bits at 8. |

## → Parity [None]

Use the **Parity** option to specify the parity bit that can be sent with the data bits for detecting the transmission errors.

- |   |              |                |   |
|---|--------------|----------------|---|
| → | <b>None</b>  | <b>DEFAULT</b> | No parity bit is sent with the data bits.                                 |
| → | <b>Even</b>  |                | The parity bit is 0 if the number of ones in the data bits is even.       |
| → | <b>Odd</b>   |                | The parity bit is 0 if the number of ones in the data bits is odd.        |
| → | <b>Mark</b>  |                | The parity bit is always 1. This option does not provide error detection. |
| → | <b>Space</b> |                | The parity bit is always 0. This option does not provide error detection. |



## ECN-360A-ULT3 Embedded System

Use the **Hyper-Threading** BIOS option to enable or disable the Intel Hyper-Threading Technology.

- ➔ **Disabled** Disables the Intel Hyper-Threading Technology.
- ➔ **Enabled** **DEFAULT** Enables the Intel Hyper-Threading Technology.

➔ **Active Processor Cores** [All]

Use the **Active Processor Cores** BIOS option to enable numbers of cores in the processor package.

- ➔ **All** **DEFAULT** Enable all cores in the processor package.
- ➔ **1** Enable one core in the processor package.

➔ **Intel® Virtualization Technology** [Enabled]

Use the **Intel® Virtualization Technology** option to enable or disable virtualization on the system. When combined with third party software, Intel® Virtualization technology allows several OSs to run on the same system at the same time.

- ➔ **Disabled** Disables Intel® Virtualization Technology.
- ➔ **Enabled** **DEFAULT** Enables Intel® Virtualization Technology.

➔ **Intel® SpeedStep™** [Enabled]

Use the **Intel® SpeedStep™** option to enable or disable the Intel® SpeedStep™ Technology.

- ➔ **Disabled** Disables the Intel® SpeedStep™ Technology.
- ➔ **Enabled** **DEFAULT** Enables the Intel® SpeedStep™ Technology.

➔ **CPU C States** [Disabled]

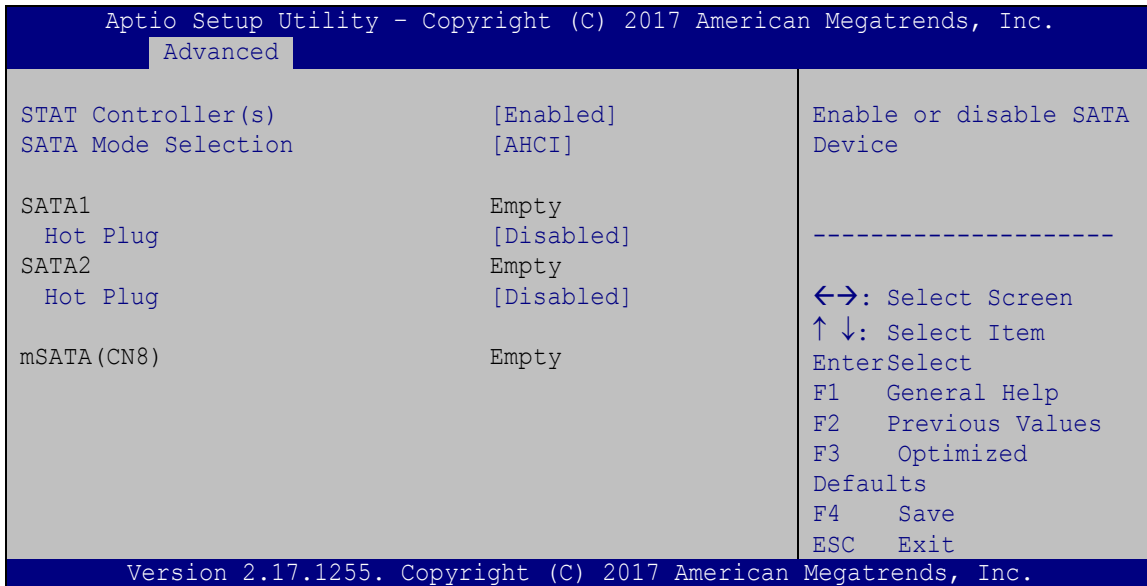
Use the **CPU C States** option to enable or disable CPU C states.

- ➔ **Disabled** **DEFAULT** Disables CPU C states.

- ➔ **Enabled**                      Enables CPU C states.

### 5.3.8 SATA Configuration

Use the **SATA Configuration** menu (**BIOS Menu 14**) to change and/or set the configuration of the SATA devices installed in the system.



#### BIOS Menu 14: SATA Configuration

- ➔ STAT Controller(s) [Enabled]

Use the **STAT Controller(s)** option to enable or disable the SATA device.

- ➔ **Enabled**                      **DEFAULT**      Enables the SATA device.
- ➔ **Disabled**                      Disables the SATA device.

- ➔ SATA Mode Selection [AHCI]

Use the **SATA Mode Selection** option to configure SATA devices as AHCI devices.

- ➔ **AHCI**                      **DEFAULT**      Configures SATA devices as AHCI device.
- ➔ **RAID**                      Configures SATA devices as RAID device.

**NOTE:**

Before accessing the RAID configuration utility, ensure to set the **Option ROM Messages** BIOS option in the **Boot** menu to **Force BIOS**. This is to allow the “Press <CTRL+I> to enter Configuration Utility.....” message to appear during POST. Press Ctrl+I when prompted to enter the RAID configuration utility.

**→ Hot Plug [Disabled]**

Use the **Hot Plug** option to enable or disable the SATA device hot plug.

- |                   |                |                                    |
|-------------------|----------------|------------------------------------|
| <b>→ Disabled</b> | <b>DEFAULT</b> | Disables the SATA device hot plug. |
| <b>→ Enabled</b>  |                | Enables the SATA device hot plug   |



### 5.3.9 USB Configuration

Use the **USB Configuration** menu (**BIOS Menu 15**) to read USB configuration information and configure the USB settings.



#### BIOS Menu 15: USB Configuration

##### ➔ USB Devices

The **USB Devices Enabled** field lists the USB devices that are enabled on the system

##### ➔ Legacy USB Support [Enabled]

Use the **Legacy USB Support** BIOS option to enable USB mouse and USB keyboard support. Normally if this option is not enabled, any attached USB mouse or USB keyboard does not become available until a USB compatible operating system is fully booted with all USB drivers loaded. When this option is enabled, any attached USB mouse or USB keyboard can control the system even when there is no USB driver loaded onto the system.

## ECN-360A-ULT3 Embedded System

- ➔ **Enabled**      **DEFAULT**      Legacy USB support enabled
- ➔ **Disabled**                      Legacy USB support disabled
- ➔ **Auto**                              Legacy USB support disabled if no USB devices are connected

### 5.3.10 IEI Feature

Use the **IEI Feature** menu (**BIOS Menu 16**) to configure One Key Recovery function.



#### BIOS Menu 16: IEI Feature

- ➔ Auto Recovery Function [Disabled]

Use the **Auto Recovery Function** BIOS option to enable or disable the auto recovery function of the IEI One Key Recovery.

- ➔ **Disabled**      **DEFAULT**      Auto recovery function disabled
- ➔ **Enabled**                      Auto recovery function enabled

## 5.4 Chipset

Use the **Chipset** menu (**BIOS Menu 17**) to configure the system chipset.

```

Aptio Setup Utility - Copyright (C) 2017 American Megatrends, Inc.
Main   Advanced  Chipset   Boot   Security  Save & Exit  Server Mgmt
-----
> System Agent (SA) Configuration
> PCH-IO Configuration

System Agent (SA)
Parameters

-----
<=>: Select Screen
↑↓: Select Item
Enter>Select
+ - Change Opt.
F1  General Help
F2  Previous Values
F3  Optimized Defaults
F4  Save & Exit
ESC Exit

Version 2.17.1255. Copyright (C) 2017 American Megatrends, Inc.
    
```

### BIOS Menu 17: Chipset

#### 5.4.1 System Agent (SA) Configuration

Use the **System Agent (SA) Configuration** menu (**BIOS Menu 18**) to configure the System Agent (SA) parameters.

```

Aptio Setup Utility - Copyright (C) 2017 American Megatrends, Inc.
Chipset
-----
VT-d                               [Disabled]          VT-d capability

> Graphics Configuration
> Memory Configuration

-----
<=>: Select Screen
↑↓: Select Item
Enter>Select
+ - Change Opt.
F1  General Help
F2  Previous Values
F3  Optimized Defaults
F4  Save & Exit
ESC Exit

Version 2.17.1255. Copyright (C) 2017 American Megatrends, Inc.
    
```

### BIOS Menu 18: System Agent (SA) Configuration

## ECN-360A-ULT3 Embedded System

➔ VT-d [Disabled]

Use the **VT-d** option to enable or disable VT-d support.

➔ **Disabled** **DEFAULT** Disable VT-d support.

➔ **Enabled** Enable VT-d support.

### 5.4.1.1 Graphics Configuration

Use the **Graphics Configuration** menu (**BIOS Menu 19**) to configure the graphics settings.

```

Aptio Setup Utility - Copyright (C) 2017 American Megatrends, Inc.
Chipset
Graphics Configuration
Primary Display          [Auto]
Internal Graphics       [Enabled]
DVMT Pre-Allocated      [256M]
DVMT Total Gfx Mem     [MAX]
> LCD Control

Select which of
Auto/IGFX/PCIE Graphics
device should be Primary
Display Or select SG for
Switchable Gfx.

-----
<=>: Select Screen
↑↓: Select Item
Enter>Select
+ - Change Opt.
F1  General Help
F2  Previous Values
F3  Optimized Defaults
F4  Save & Exit
ESC Exit

Version 2.17.1255. Copyright (C) 2017 American Megatrends, Inc.
  
```

#### BIOS Menu 19: Graphics Configuration

➔ Primary Display [Auto]

Use the **Primary Display** option to select the graphics controller used as the primary boot device. Configuration options are listed below:

- Auto **DEFAULT**
- IGFX
- PCIE

→ Internal Graphics [Enabled]

Use the **Internal Graphics** option to enable or disable the internal graphics device.

- **Auto**                      The internal graphics device is automatically detected and enabled.
- **Disabled**                 Disable the internal graphics device.
- **Enabled**    **DEFAULT**    Enable the internal graphics device. The following options/submenu appear with values that can be selected:

DVMT Pre-Allocated

DVMT Total Gfx Mem

LCD Control

→ DVMT Pre-Allocated [256M]

Use the **DVMT Pre-Allocated** option to set the amount of system memory allocated to the integrated graphics processor when the system boots. The system memory allocated can then only be used as graphics memory, and is no longer available to applications or the operating system. Configuration options are listed below:

- 32M
- 64M
- 128M
- 256M                      **DEFAULT**
- 512M

→ DVMT Total Gfx Mem [MAX]

Use the **DVMT Total Gfx Mem** option to select DVMT 5.0 total graphic memory size used by the internal graphics device. The following options are available:

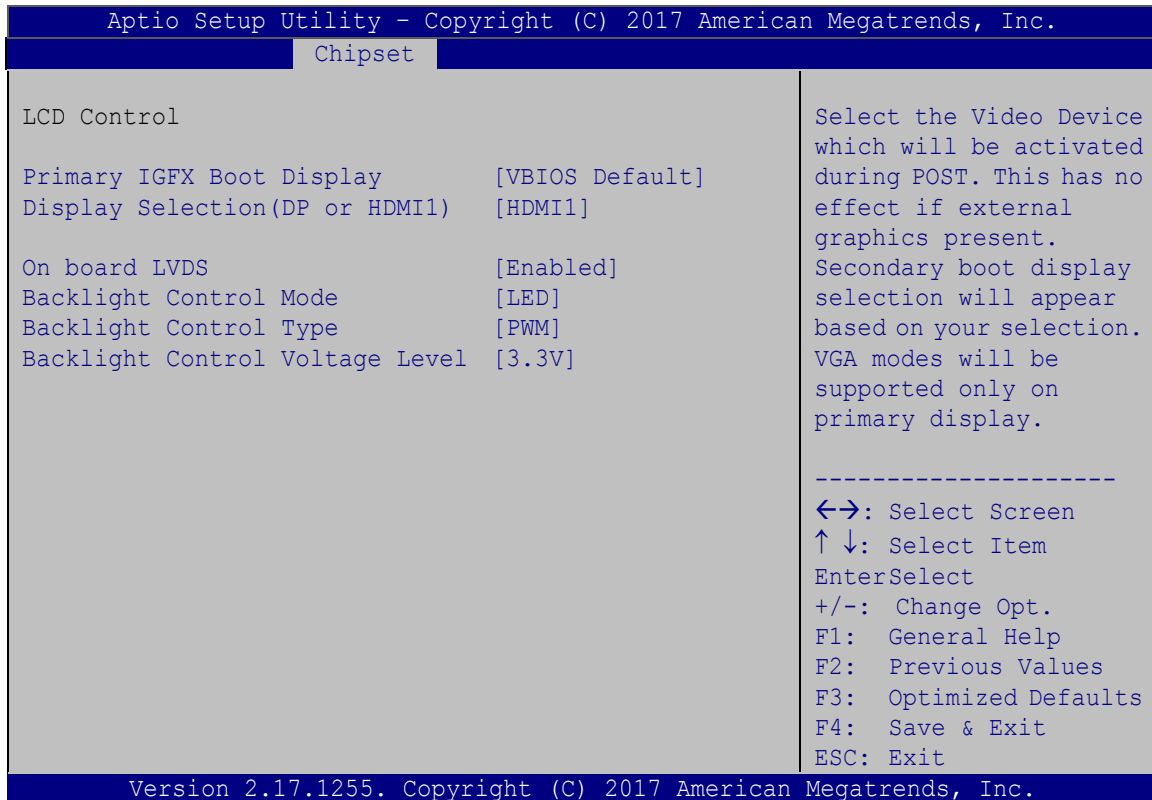
- 128M
- 256M
- MAX                      **DEFAULT**



## ECN-360A-ULT3 Embedded System

### 5.4.1.1.1 LCD Control

Use the **LCD Control** submenu (**BIOS Menu 20**) to select a display device which will be activated during POST.



#### BIOS Menu 20: LCD Control

##### → Primary IGFX Boot Display [VBIOS Default]

Use the **Primary IGFX Boot Display** option to select the display device used by the system when it boots.

- VBIOS Default **DEFAULT**
- HDMI2
- LVDS
- DP/HDMI1

##### → Display Selection (DP or HDMI1) [HDMI1]

Use the **Display Selection (DP or HDMI1)** option to select DP or HDMI1 for display.

- DP
- HDMI1            **DEFAULT**

➔ On board LVDS [Enabled]

Use the **On board LVDS** option enables or disables the on-board LVDS connector.

- ➔ **Disabled**                            The on-board LVDS connector is disabled.
- ➔ **Enabled**            **DEFAULT**            The on-board LVDS connector is disabled.

➔ Backlight Control Mode [LED]

Use the **Backlight Control Mode** option to specify the backlight control mode. Configuration options are listed below.

- LED                    **DEFAULT**
- CCFL

➔ Backlight Control Type [PWM]

Use the **Backlight Control Type** option to specify the backlight control type. Configuration options are listed below.

- PWM            **DEFAULT**
- DC

➔ Backlight Control Voltage Level [3.3V]

Use the **Backlight Control Voltage Level** option to specify the backlight control voltage. Configuration options are listed below.

- 3.3V            **DEFAULT**
- 5.0V

## ECN-360A-ULT3 Embedded System

### 5.4.1.2 Memory Configuration

Use the **Memory Configuration** submenu (**BIOS Menu 21**) to display the memory information.

```

Aptio Setup Utility - Copyright (C) 2017 American Megatrends, Inc.
Chipset
Memory Information
Total Memory          4096 MB
DIMM1                 Not Present
DIMM2                 4096 MB
-----
<->: Select Screen
↑ ↓: Select Item
EnterSelect
+ - Change Opt.
F1  General Help
F2  Previous Values
F3  Optimized Defaults
F4  Save & Exit
ESC Exit

Version 2.17.1255. Copyright (C) 2017 American Megatrends, Inc.

```

**BIOS Menu 21: Memory Configuration**

### 5.4.2 PCH-IO Configuration

Use the **PCH-IO Configuration** menu (**BIOS Menu 22**) to configure the PCH-IO chipset.

```

Aptio Setup Utility - Copyright (C) 2017 American Megatrends, Inc.
Chipset
Auto Power Button Status [Disable (ATX)]
Restore AC Power Loss    [Last State]
> PCI Express Configuration
> HD Audio Configuration
Power Saving Function(ERP) [Disabled]
-----
<->: Select Screen
↑ ↓: Select Item
EnterSelect
+ - Change Opt.
F1  General Help
F2  Previous Values
F3  Optimized Defaults
F4  Save & Exit
ESC Exit

Version 2.17.1255. Copyright (C) 2017 American Megatrends, Inc.

```

**BIOS Menu 22: PCH-IO Configuration**

➔ Restore AC Power Loss [Last State]

Use the **Restore AC Power** BIOS option to specify what state the system returns to if there is a sudden loss of power to the system.

- ➔ **Power Off**                      The system remains turned off
- ➔ **Power On**                        The system turns on
- ➔ **Last State**    **DEFAULT**    The system returns to its previous state. If it was on, it turns itself on. If it was off, it remains off.

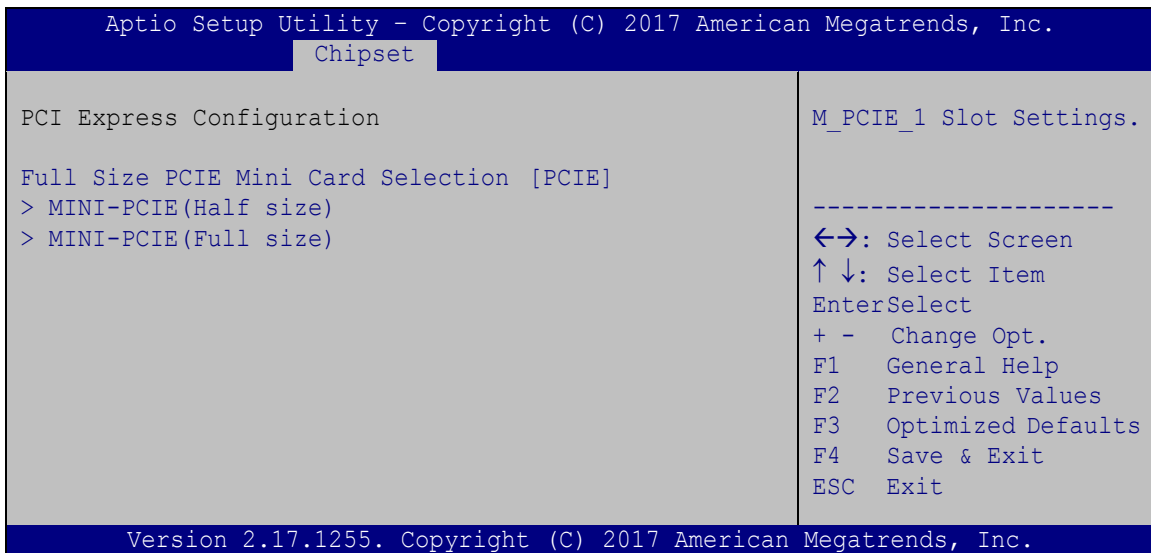
➔ Power Saving Function (ERP) [Disabled]

Use the **Power Saving Function (ERP)** option to enable or disable the power saving function.

- ➔ **Disabled**    **DEFAULT**    Disables the power saving function.
- ➔ **Enabled**                      Enables the power saving function.

### 5.4.2.1 PCI Express Configuration

Use the **PCI Express Configuration** submenu (**BIOS Menu 23**) to configure the PCI Express slots.



**BIOS Menu 23: PCI Express Configuration**

## ECN-360A-ULT3 Embedded System

## → Full Size PCIE Mini Card Selection [PCIE]

Use the **Full Size PCIE Mini Card Selection** BIOS option to configure the full-size PCIe Mini slot (CN8) as PCIe Mini slot or mSATA slot.

- **PCIE**            **DEFAULT**    Configure the full-size PCIe Mini slot as PCIe Mini slot
- **mSATA**                            Configure the full-size PCIe Mini slot as mSATA slot

The **MINI-PCIE (Half size)** and **MINI-PCIE (Full size)** submenus both contain the following options:

## → PCIe Speed [Auto]

Use the **PCIe Speed** option to configure the PCIe interface speed.

- Auto                    **DEFAULT**
- Gen 1
- Gen 2
- Gen 3

## → Detect Non-Compliance Device [Disabled]

Use the **Detect Non-Compliance Device** option to enable or disable detecting if a non-compliance PCI Express device is connected to the PCI Express slot.

- **Disabled**            **DEFAULT**    Disables to detect if a non-compliance PCI Express device is connected to the PCI Express slot.
- **Enabled**                            Enables to detect if a non-compliance PCI Express device is connected to the PCI Express slot.



### 5.4.2.2 HD Audio Configuration

Use the **HD Audio Configuration** submenu (**BIOS Menu 24**) to configure the High Definition Audio codec.



#### BIOS Menu 24: HD Audio Configuration

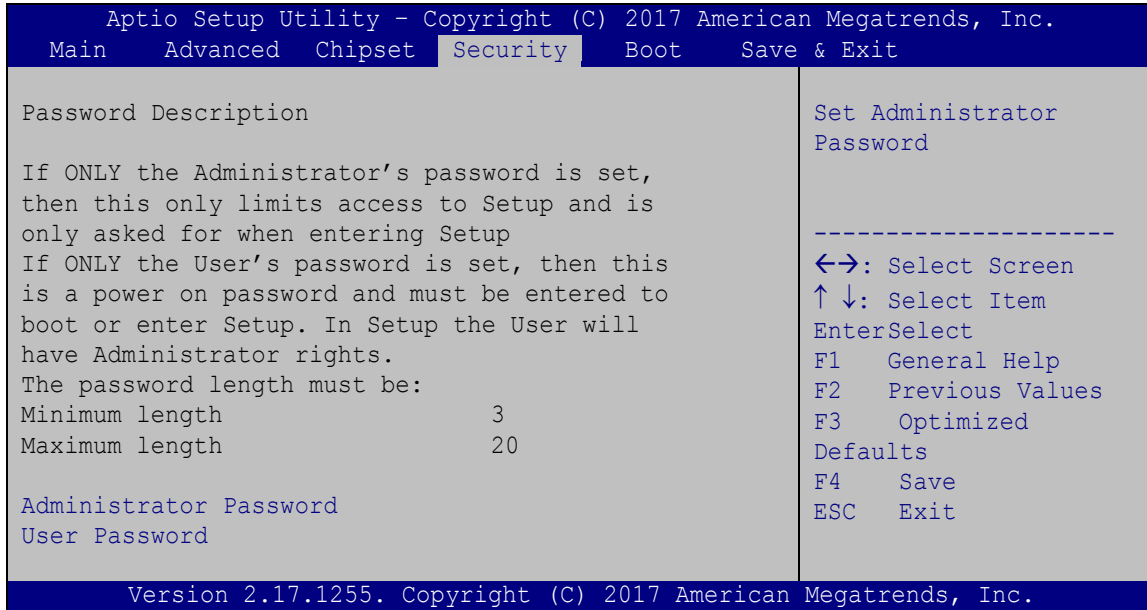
→ HD Audio [Enabled]

Use the **HD Audio** BIOS option to enable or disable the High Definition Audio controller.

- **Disabled**                      The High Definition Audio controller is disabled.
- **Enabled**            **DEFAULT**      The High Definition Audio controller is enabled.

## 5.5 Security

Use the **Security** menu (**BIOS Menu 25**) to set system and user passwords.



### BIOS Menu 25: Security

➔ Administrator Password

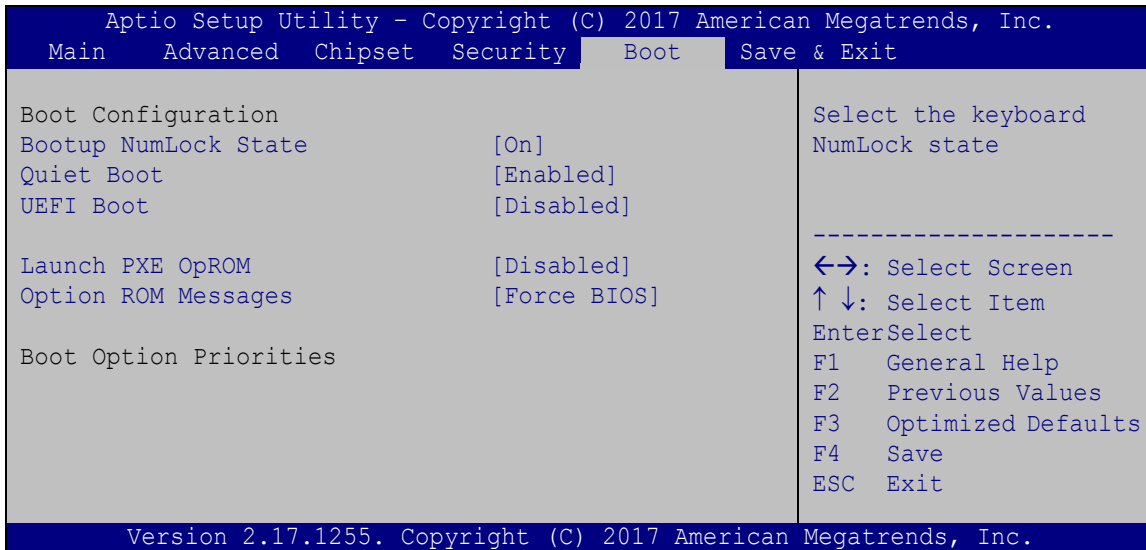
Use the **Administrator Password** to set or change a administrator password.

➔ User Password

Use the **User Password** to set or change a user password.

## 5.6 Boot

Use the **Boot** menu (**BIOS Menu 26**) to configure system boot options.



### BIOS Menu 26: Boot

#### → Bootup NumLock State [On]

Use the **Bootup NumLock State** BIOS option to specify if the number lock setting must be modified during boot up.

→ **On**                      **DEFAULT**                      Allows the Number Lock on the keyboard to be enabled automatically when the computer system boots up. This allows the immediate use of the 10-key numeric keypad located on the right side of the keyboard. To confirm this, the Number Lock LED light on the keyboard is lit.

→ **Off**    Does not enable the keyboard Number Lock automatically. To use the 10-keys on the keyboard, press the Number Lock key located on the upper left-hand corner of the 10-key pad. The Number Lock LED on the keyboard lights up when the Number Lock is engaged.

## ECN-360A-ULT3 Embedded System

## → Quiet Boot [Enabled]

Use the **Quiet Boot** BIOS option to select the screen display when the system boots.

- **Disabled** Normal POST messages displayed
- **Enabled** **DEFAULT** OEM Logo displayed instead of POST messages

## → UEFI Boot [Disabled]

Use the **UEFI Boot** option to enable or disable to boot from the UEFI devices.

- **Enabled** Boot from UEFI devices is enabled.
- **Disabled** **DEFAULT** Boot from UEFI devices is disabled.

## → Launch PXE OpROM [Disabled]

Use the **Launch PXE OpROM** option to enable or disable boot option for legacy network devices.

- **Disabled** **DEFAULT** Ignore all PXE Option ROMs
- **Enabled** Load PXE Option ROMs.

## → Option ROM Messages [Force BIOS]

Use the **Option ROM Messages** option to set the Option ROM display mode.

- **Force BIOS** **DEFAULT** Sets display mode to force BIOS.
- **Keep Current** Sets display mode to current.

## → Boot Option Priority

Use the **Boot Option Priority** function to set the system boot sequence from the available devices. The drive sequence also depends on the boot sequence in the individual device section.

## 5.7 Exit

Use the **Exit** menu (**BIOS Menu 27**) to load default BIOS values, optimal failsafe values and to save configuration changes.

```
Aptio Setup Utility - Copyright (C) 2017 American Megatrends, Inc.
Main  Advanced  Chipset  Security  Boot  Save & Exit
-----
Save Changes and Reset
Discard Changes and Reset

Restore Defaults
Save as User Defaults
Restore User Defaults

Reset the system after
saving the changes.

-----
<->: Select Screen
↑ ↓: Select Item
Enter>Select
F1  General Help
F2  Previous Values
F3  Optimized
Defaults
F4  Save
ESC Exit

Version 2.17.1255. Copyright (C) 2017 American Megatrends, Inc.
```

### BIOS Menu 27: Exit

#### → Save Changes and Reset

Use the **Save Changes and Reset** option to save the changes made to the BIOS options and to exit the BIOS configuration setup program.

#### → Discard Changes and Reset

Use the **Discard Changes and Reset** option to exit the system without saving the changes made to the BIOS configuration setup program.

#### → Restore Defaults

Use the **Restore Defaults** option to load the optimal default values for each of the parameters on the Setup menus. **F3 key can be used for this operation.**



## ECN-360A-ULT3 Embedded System

➔ Save as User Defaults

Use the **Save as User Defaults** option to save the changes done so far as user defaults.

➔ Restore User Defaults

Use the **Restore User Defaults** option to restore the user defaults to all the setup options.

Appendix

A

# Regulatory Compliance

---

## DECLARATION OF CONFORMITY



This equipment is in conformity with the following EU directives:

- EMC Directive (2004/108/EC, 2014/30/EU)
- Low-Voltage Directive (2006/95/EC, 2014/35/EU)
- RoHS II Directive (2011/65/EU, 2015/863/EU)

If the user modifies and/or install other devices in the equipment, the CE conformity declaration may no longer apply.

If this equipment has telecommunications functionality, it also complies with the requirements of the Radio Equipment Directive 2014/53/EU.

---

English

IEI Integration Corp declares that this equipment is in compliance with the essential requirements and other relevant provisions of Directive 2014/53/EU.

---

Български [Bulgarian]

IEI Integration Corp. декларира, че този оборудване е в съответствие със съществените изисквания и другите приложим правила на Директива 2014/53/EU.

---

Česky [Czech]

IEI Integration Corp tímto prohlašuje, že tento zařizení je ve shodě s základními požadavky a dalšími příslušnými ustanoveními směrnice 2014/53/EU.

---

Dansk [Danish]

IEI Integration Corp erklærer herved, at følgende udstyr overholder de væsentlige krav og øvrige relevante krav i direktiv 2014/53/EU.

---

---

Deutsch [German]

IEI Integration Corp, erklärt dieses Gerät entspricht den grundlegenden Anforderungen und den weiteren entsprechenden Vorgaben der Richtlinie 2014/53/EU.

---

Eesti [Estonian]

IEI Integration Corp deklareerib seadme seadme vastavust direktiivi 2014/53/EÜ põhinõuetele ja nimetatud direktiivist tulenevatele teistele asjakohastele sätetele.

---

Español [Spanish]

IEI Integration Corp declara que el equipo cumple con los requisitos esenciales y cualesquiera otras disposiciones aplicables o exigibles de la Directiva 2014/53/EU.

---

Ελληνική [Greek]

IEI Integration Corp ΔΗΛΩΝΕΙ ΟΤΙ ΕΞΟΠΛΙΣΜΟΣ ΣΥΜΜΟΡΦΩΝΕΤΑΙ ΠΡΟΣ ΤΙΣ ΟΥΣΙΩΔΕΙΣ ΑΠΑΙΤΗΣΕΙΣ ΚΑΙ ΤΙΣ ΛΟΙΠΕΣ ΣΧΕΤΙΚΕΣ ΔΙΑΤΑΞΕΙΣ ΤΗΣ ΟΔΗΓΙΑΣ 2014/53/EU.

---

Français [French]

IEI Integration Corp déclare que l'appareil est conforme aux exigences essentielles et aux autres dispositions pertinentes de la directive 2014/53/EU.

---

Italiano [Italian]

IEI Integration Corp dichiara che questo apparecchio è conforme ai requisiti essenziali ed alle altre disposizioni pertinenti stabilite dalla direttiva 2014/53/EU.

---

Latviski [Latvian]

IEI Integration Corp deklarē, ka iekārta atbilst būtiskajām prasībām un citiem ar to saistītajiem noteikumiem Direktīvas 2014/53/EU.

---

---

Lietuvių [Lithuanian]

IEI Integration Corp deklaruoja, kad šis įranga atitinka esminius reikalavimus ir kitas 2014/53/EU Direktyvos nuostatas.

---

Nederlands [Dutch]

IEI Integration Corp dat het toestel toestel in overeenstemming is met de essentiële eisen en de andere relevante bepalingen van richtlijn 2014/53/EU.

---

Malti [Maltese]

IEI Integration Corp jiddikjara li dan prodott jikkonforma mal-ħtiġijiet essenzjali u ma provvedimenti oħrajn relevanti li hemm fid-Dirrettiva 2014/53/EU.

---

Magyar [Hungarian]

IEI Integration Corp nyilatkozom, hogy a berendezés megfelel a vonatkozó alapvető követelményeknek és az 2014/53/EU irányelv egyéb előírásainak.

---

Polski [Polish]

IEI Integration Corp oświadcza, że wyrobu jest zgodny z zasadniczymi wymogami oraz pozostałymi stosownymi postanowieniami Dyrektywy 2014/53/EU.

---

Português [Portuguese]

IEI Integration Corp declara que este equipamento está conforme com os requisitos essenciais e outras disposições da Directiva 2014/53/EU.

---

Româna [Romanian]

IEI Integration Corp declară că acest echipament este în conformitate cu cerințele esențiale și cu celelalte prevederi relevante ale Directivei 2014/53/EU.

---



---

Slovensko [Slovenian]

IEI Integration Corp izjavlja, da je ta opreme v skladu z bistvenimi zahtevami in ostalimi relevantnimi določili direktive 2014/53/EU.

---

Slovensky [Slovak]

IEI Integration Corp týmto vyhlasuje, že zariadenia spĺňa základné požiadavky a všetky príslušné ustanovenia Smernice 2014/53/EU.

---

Suomi [Finnish]

IEI Integration Corp vakuuttaa täten että laitteet on direktiivin 2014/53/EU oleellisten vaatimusten ja sitä koskevien direktiivin muiden ehtojen mukainen.

---

Svenska [Swedish]

IEI Integration Corp förklarar att denna utrustningstyp står i överensstämmelse med de väsentliga egenskapskrav och övriga relevanta bestämmelser som framgår av direktiv 2014/53/EU.

---

## FCC WARNING



This equipment complies with Part 15 of the FCC Rules. Operation is subject to the following two conditions:

- This device may not cause harmful interference, and
- This device must accept any interference received, including interference that may cause undesired operation.

This equipment has been tested and found to comply with the limits for a Class A digital device, pursuant to part 15 of the FCC Rules. These limits are designed to provide reasonable protection against harmful interference when the equipment is operated in a commercial environment. This equipment generates, uses, and can radiate radio frequency energy and, if not installed and used in accordance with the instruction manual, may cause harmful interference to radio communications. Operation of this equipment in a residential area is likely to cause harmful interference in which case the user will be required to correct the interference at his own expense.

**Federal Communication Commission Interference Statement**

This equipment has been assembled with components that comply with the limits for a Class B digital device, pursuant to Part 15 of the FCC Rules. These limits are designed to provide reasonable protection against harmful interference in a residential installation. This equipment generates, uses and can radiate radio frequency energy and, if not installed and used in accordance with the instructions, may cause harmful interference to radio communications. However, there is no guarantee that interference will not occur in a particular installation. If this equipment does cause harmful interference to radio or television reception, which can be determined by turning the equipment off and on, the user is encouraged to try to correct the interference by one of the following measures:

- Reorient or relocate the receiving antenna.
- Increase the separation between the equipment and receiver.
- Connect the equipment into an outlet on a circuit different from that to which the receiver is connected.
- Consult the dealer or an experienced radio/TV technician for help.

Appendix

**B**

# Safety Precautions

---

## B.1 Safety Precautions

---



### WARNING:

The precautions outlined in this appendix should be strictly followed. Failure to follow these precautions may result in permanent damage to the ECN-360A-ULT3.

---

Please follow the safety precautions outlined in the sections that follow:

### B.1.1 General Safety Precautions

Please ensure the following safety precautions are adhered to at all times.

- ***Make sure the power is turned off and the power cord is disconnected*** when moving, installing or modifying the system.
- ***Do not apply voltage levels that exceed the specified voltage range.*** Doing so may cause fire and/or an electrical shock.
- ***Electric shocks can occur*** if opened while still powered on.
- ***Do not drop or insert any objects*** into the ventilation openings.
- ***If considerable amounts of dust, water, or fluids enter the system***, turn off the power supply immediately, unplug the power cord, and contact the system vendor.
- **DO NOT:**
  - Drop the system against a hard surface.
  - In a site where the ambient temperature exceeds the rated temperature

### B.1.2 Anti-static Precautions

---



### WARNING:

Failure to take ESD precautions during the installation of the ECN-360A-ULT3 may result in permanent damage to the ECN-360A-ULT3 and severe injury to the user.

---

Electrostatic discharge (ESD) can cause serious damage to electronic components, including the ECN-360A-ULT3. Dry climates are especially susceptible to ESD. It is therefore critical that whenever the ECN-360A-ULT3 is opened and any of the electrical components are handled, the following anti-static precautions are strictly adhered to.

- **Wear an anti-static wristband:** Wearing a simple anti-static wristband can help to prevent ESD from damaging any electrical component.
- **Self-grounding:** Before handling any electrical component, touch any grounded conducting material. During the time the electrical component is handled, frequently touch any conducting materials that are connected to the ground.
- **Use an anti-static pad:** When configuring or working with an electrical component, place it on an anti-static pad. This reduces the possibility of ESD damage.
- **Only handle the edges of the electrical component:** When handling the electrical component, hold the electrical component by its edges.

### B.1.3 Product Disposal

---



#### CAUTION:

Risk of explosion if battery is replaced by an incorrect type. Only certified engineers should replace the on-board battery.

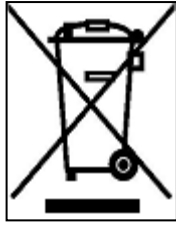
Dispose of used batteries according to instructions and local regulations.

---

- Outside the European Union - If you wish to dispose of used electrical and electronic products outside the European Union, please contact your local authority so as to comply with the correct disposal method.
- Within the European Union - The device that produces less waste and is easier to recycle is classified as electronic device in terms of the European Directive 2012/19/EU (WEEE), and must not be disposed of as domestic garbage.



## ECN-360A-ULT3 Embedded System



EU-wide legislation, as implemented in each Member State, requires that waste electrical and electronic products carrying the mark (left) must be disposed of separately from normal household waste. This includes monitors and electrical accessories, such as signal cables or power cords. When you need to dispose of your device, please follow the guidance of your local authority, or ask the shop where you purchased the product.

The mark on electrical and electronic products only applies to the current European Union Member States.

Please follow the national guidelines for electrical and electronic product disposal.

## B.2 Maintenance and Cleaning Precautions

When maintaining or cleaning the ECN-360A-ULT3, please follow the guidelines below.

### B.2.1 Maintenance and Cleaning

Prior to cleaning any part or component of the ECN-360A-ULT3, please read the details below.

- The interior of the ECN-360A-ULT3 does not require cleaning. Keep fluids away from the ECN-360A-ULT3 interior.
- Be cautious of all small removable components when vacuuming the ECN-360A-ULT3.
- Turn the ECN-360A-ULT3 off before cleaning the ECN-360A-ULT3.
- Never drop any objects or liquids through the openings of the ECN-360A-ULT3.
- Be cautious of any possible allergic reactions to solvents or chemicals used when cleaning the ECN-360A-ULT3.
- Avoid eating, drinking and smoking within vicinity of the ECN-360A-ULT3.

### B.2.2 Cleaning Tools

Some components in the ECN-360A-ULT3 may only be cleaned using a product specifically designed for the purpose. In such case, the product will be explicitly mentioned in the cleaning tips. Below is a list of items to use when cleaning the ECN-360A-ULT3.

- **Cloth** – Although paper towels or tissues can be used, a soft, clean piece of cloth is recommended when cleaning the ECN-360A-ULT3.
- **Water or rubbing alcohol** – A cloth moistened with water or rubbing alcohol can be used to clean the ECN-360A-ULT3.
- **Using solvents** – The use of solvents is not recommended when cleaning the ECN-360A-ULT3 as they may damage the plastic parts.
- **Vacuum cleaner** – Using a vacuum specifically designed for computers is one of the best methods of cleaning the ECN-360A-ULT3. Dust and dirt can restrict the airflow in the ECN-360A-ULT3 and cause its circuitry to corrode.
- **Cotton swabs** - Cotton swaps moistened with rubbing alcohol or water are excellent tools for wiping hard to reach areas.
- **Foam swabs** - Whenever possible, it is best to use lint free swabs such as foam swabs for cleaning.

Appendix

C

# Watchdog Timer

---



**NOTE:**

The following discussion applies to DOS environment. Contact IEI support or visit the IEI website for specific drivers for other operating systems.

The Watchdog Timer is provided to ensure that standalone systems can always recover from catastrophic conditions that cause the CPU to crash. This condition may have occurred by external EMIs or a software bug. When the CPU stops working correctly, Watchdog Timer either performs a hardware reset (cold boot) or a Non-Maskable Interrupt (NMI) to bring the system back to a known state.

A BIOS function call (INT 15H) is used to control the Watchdog Timer.

INT 15H:

AH – 6FH Sub-function:	
AL – 2:	Sets the Watchdog Timer's period.
BL:	Time-out value (Its unit-second is dependent on the item "Watchdog Timer unit select" in CMOS setup).

**Table C-1: AH-6FH Sub-function**

Call sub-function 2 to set the time-out period of Watchdog Timer first. If the time-out value is not zero, the Watchdog Timer starts counting down. When the timer value reaches zero, the system resets. To ensure that this reset condition does not occur, calling sub-function 2 must periodically refresh the Watchdog Timer. However, the watchdog timer is disabled if the time-out value is set to zero.

A tolerance of at least 10% must be maintained to avoid unknown routines within the operating system (DOS), such as disk I/O that can be very time-consuming.

**NOTE:**

When exiting a program it is necessary to disable the Watchdog Timer, otherwise the system resets.

**EXAMPLE PROGRAM:**

**; INITIAL TIMER PERIOD COUNTER**

;

**W\_LOOP:**

;

```

MOV      AX, 6F02H      ;setting the time-out value
MOV      BL, 30         ;time-out value is 48 seconds
INT      15H

```

;

**; ADD THE APPLICATION PROGRAM HERE**

;

```

CMP      EXIT_AP, 1     ;is the application over?
JNE      W_LOOP        ;No, restart the application

MOV      AX, 6F02H     ;disable Watchdog Timer
MOV      BL, 0         ;
INT      15H

```

;

**; EXIT ;**



Appendix

D

# Hazardous Materials Disclosure

---

## ECN-360A-ULT3 Embedded System

The details provided in this appendix are to ensure that the product is compliant with the Peoples Republic of China (China) RoHS standards. The table below acknowledges the presences of small quantities of certain materials in the product, and is applicable to China RoHS only.

A label will be placed on each product to indicate the estimated “Environmentally Friendly Use Period” (EFUP). This is an estimate of the number of years that these substances would “not leak out or undergo abrupt change.” This product may contain replaceable sub-assemblies/components which have a shorter EFUP such as batteries and lamps. These components will be separately marked.

Please refer to the following table.

Part Name	Toxic or Hazardous Substances and Elements					
	Lead (Pb)	Mercury (Hg)	Cadmium (Cd)	Hexavalent Chromium (CR(VI))	Polybrominated Biphenyls (PBB)	Polybrominated Diphenyl Ethers (PBDE)
Housing	O	O	O	O	O	O
Display	O	O	O	O	O	O
Printed Circuit Board	O	O	O	O	O	O
Metal Fasteners	O	O	O	O	O	O
Cable Assembly	O	O	O	O	O	O
Fan Assembly	O	O	O	O	O	O
Power Supply Assemblies	O	O	O	O	O	O
Battery	O	O	O	O	O	O

O: This toxic or hazardous substance is contained in all of the homogeneous materials for the part is below the limit requirement in SJ/T11363-2006 (now replaced by GB/T 26572-2011).

X: This toxic or hazardous substance is contained in at least one of the homogeneous materials for this part is above the limit requirement in SJ/T11363-2006 (now replaced by GB/T 26572-2011).

此附件旨在确保本产品符合中国 RoHS 标准。以下表格标示此产品中某有毒物质的含量符合中国 RoHS 标准规定的限量要求。

本产品上会附有“环境友好使用期限”的标签，此期限是估算这些物质“不会有泄漏或突变”的年限。本产品可能包含有较短的环境友好使用期限的可替换元件，像是电池或灯管，这些元件将会单独标示出来。

部件名称	有毒有害物质或元素					
	铅 (Pb)	汞 (Hg)	镉 (Cd)	六价铬 (CR(VI))	多溴联苯 (PBB)	多溴二苯 醚 (PBDE)
壳体	O	O	O	O	O	O
显示	O	O	O	O	O	O
印刷电路板	O	O	O	O	O	O
金属螺帽	O	O	O	O	O	O
电缆组装	O	O	O	O	O	O
风扇组装	O	O	O	O	O	O
电力供应组装	O	O	O	O	O	O
电池	O	O	O	O	O	O

O: 表示该有毒有害物质在该部件所有物质材料中的含量均在 SJ/T 11363-2006 (现由 GB/T 26572-2011 取代) 标准规定的限量要求以下。

X: 表示该有毒有害物质至少在该部件的某一均质材料中的含量超出 SJ/T 11363-2006 (现由 GB/T 26572-2011 取代) 标准规定的限量要求。