



MODEL:
DRPC-230-ULT5

**Fanless Embedded System with Intel® Core™ i5-8365UE CPU,
Triple GbE, Four RS-232/422/485, Two RS-232,
USB 3.2 Gen 2, HDMI, DisplayPort, 12V~24V DC Power Input,
DIN Rail Mounting Support, RoHS Compliant**

User Manual

Revision

Date	Version	Changes
April 20, 2020	1.00	Initial release

Copyright

COPYRIGHT NOTICE

The information in this document is subject to change without prior notice in order to improve reliability, design and function and does not represent a commitment on the part of the manufacturer.

In no event will the manufacturer be liable for direct, indirect, special, incidental, or consequential damages arising out of the use or inability to use the product or documentation, even if advised of the possibility of such damages.

This document contains proprietary information protected by copyright. All rights are reserved. No part of this manual may be reproduced by any mechanical, electronic, or other means in any form without prior written permission of the manufacturer.

TRADEMARKS

All registered trademarks and product names mentioned herein are used for identification purposes only and may be trademarks and/or registered trademarks of their respective owners.

Manual Conventions



WARNING

Warnings appear where overlooked details may cause damage to the equipment or result in personal injury. Warnings should be taken seriously.



CAUTION

Cautionary messages should be heeded to help reduce the chance of losing data or damaging the product.



NOTE

These messages inform the reader of essential but non-critical information. These messages should be read carefully as any directions or instructions contained therein can help avoid making mistakes.



HOT SURFACE

This symbol indicates a hot surface that should not be touched without taking care.



PROTECTIVE EARTH GROUND

Indicates protective earth ground



IEC 60417-5009: STAND-BY

Table of Contents

1 INTRODUCTION.....	1
1.1 OVERVIEW.....	2
1.2 MODEL VARIATIONS.....	3
1.3 FEATURES.....	3
1.4 FRONT PANEL.....	4
1.5 TOP PANEL.....	5
1.6 TECHNICAL SPECIFICATIONS.....	6
1.7 DIMENSIONS.....	8
1.7.1 DRPC-230-ULT5-i5/8G/S Dimensions.....	8
1.7.1 DRPC-230-ULT5-i5/8G Dimensions.....	9
2 UNPACKING.....	10
2.1 ANTI-STATIC PRECAUTIONS.....	11
2.2 UNPACKING PRECAUTIONS.....	11
2.3 PACKING LIST.....	12
2.4 OPTIONAL ITEMS.....	13
3 INSTALLATION.....	14
3.1 INSTALLATION PRECAUTIONS.....	15
3.1.1 High Surface Temperature.....	15
3.2 INTERNAL ACCESS PANEL REMOVAL.....	16
3.3 HDD INSTALLATION.....	17
3.4 PCIe MINI CARD INSTALLATION.....	18
3.4.1 PCIe Mini Card Slot Pinouts (MINI_PCIE1).....	20
3.5 SIM CARD INSTALLATION.....	21
3.6 M.2 MODULE INSTALLATION.....	23
3.6.1 M.2 Module Slot Pinouts (M2_A1).....	24
3.7 RS-232/422/485 SERIAL PORT CONNECTION.....	26
3.8 RS-232 SERIAL PORT CONNECTION.....	26
3.9 LAN CONNECTION.....	27
3.10 AT/ATX MODE SELECTION.....	28

3.11 DIN RAIL MOUNTING	29
3.12 POWER-ON PROCEDURE.....	31
3.12.1 Installation Checklist	31
3.12.2 Terminal Block Pinouts	31
3.12.3 Power-on Procedure	32
3.13 AVAILABLE DRIVERS	33
3.13.1 Driver Download	33
4 TROUBLESHOOTING AND MAINTENANCE	35
4.1 SYSTEM MAINTENANCE OVERVIEW	36
4.2 SYSTEM TROUBLESHOOTING.....	36
4.2.1 The System Doesn't Turn On.....	36
4.2.2 The System Doesn't Boot Up.....	37
4.2.3 More Troubleshooting.....	37
4.3 MAINTENANCE.....	37
4.3.1 Clear CMOS.....	38
4.3.2 ME Override Jumper	39
5 BIOS	40
5.1 INTRODUCTION.....	41
5.1.1 Starting Setup.....	41
5.1.2 Using Setup	41
5.1.3 Getting Help.....	42
5.1.4 Unable to Reboot after Configuration Changes	42
5.1.5 BIOS Menu Bar.....	42
5.2 MAIN.....	43
5.3 ADVANCED.....	44
5.3.1 CPU Configuration.....	45
5.3.2 PCH-FW Configuration.....	47
5.3.2.1 PTT Configuration	48
5.3.3 Trusted Computing.....	49
5.3.4 ACPI Settings.....	50
5.3.5 RTC Wake Settings.....	51
5.3.6 iWDD H/W Monitor.....	52
5.3.6.1 Smart Fan Mode Configuration	53

DRPC-230-ULT5 Embedded System

5.3.7 F81866 Super IO Configuration	55
5.3.7.1 Serial Port n Configuration	56
5.3.8 Serial Port Console Redirection	57
5.3.8.1 Legacy Console Redirection Settings	58
5.3.8.2 Console Redirection Settings	59
5.3.9 USB Configuration	61
5.3.10 CSM Configuration	62
5.3.11 NVMe Configuration	63
5.3.12 IEI Feature	64
5.4 CHIPSET	65
5.4.1 System Agent (SA) Configuration	65
5.4.1.1 Memory Configuration	66
5.4.1.2 Graphics Configuration	67
5.4.2 PCH-IO Configuration	69
5.4.2.1 PCI Express Configuration	71
5.4.2.2 SATA And RST Configuration	73
5.5 SECURITY	75
5.6 BOOT	76
5.7 SAVE & EXIT	78
6 INTERFACE CONNECTORS	80
6.1 PERIPHERAL INTERFACE CONNECTORS	81
6.2 INTERNAL PERIPHERAL CONNECTORS	82
6.2.1 Battery Connector (BAT1)	82
6.2.2 Digital I/O Connector (DIO1)	83
6.2.3 Fan Connectors (CPU/FAN1, CPU/FAN2)	83
6.2.4 Internal Power Connector (PWR1)	83
6.2.5 SATA Connector (SATA1)	84
6.2.6 SMBus Connector (SMB1)	84
6.2.7 SPI Flash Connector (JSP11)	84
6.2.8 TPM Connector (TPM1)	85
6.2.9 USB DOM Connector (DOM1)	85
A REGULATORY COMPLIANCE	86
B SAFETY PRECAUTIONS	91

B.1 SAFETY PRECAUTIONS	92
<i>B.1.1 General Safety Precautions</i>	92
<i>B.1.2 Anti-static Precautions</i>	93
<i>B.1.3 Explanation of Graphical Symbols</i>	93
<i>B.1.4 Product Disposal</i>	94
B.2 MAINTENANCE AND CLEANING PRECAUTIONS	95
<i>B.2.1 Maintenance and Cleaning</i>	95
<i>B.2.2 Cleaning Tools</i>	95
C DIGITAL I/O INTERFACE	96
D WATCHDOG TIMER	99
E ERROR BEEP CODE	102
E.1 PEI BEEP CODES.....	103
E.2 DXE BEEP CODES	103
F HAZARDOUS MATERIALS DISCLOSURE	104
F.1 RoHS II DIRECTIVE (2015/863/EU)	105
F.2 CHINA RoHS.....	106

List of Figures

Figure 1-1: DRPC-230-ULT5 Series	2
Figure 1-2: Front Panel	4
Figure 1-3: Top Panel	5
Figure 1-4: DRPC-230-ULT5-i5/8G/S Dimensions (mm).....	8
Figure 1-5: DRPC-230-ULT5-i5/8G Dimensions (mm)	9
Figure 3-1: Internal Access Panel Retention Screws.....	16
Figure 3-2: HDD Installation	17
Figure 3-3: PCIe Mini Slot Location	18
Figure 3-4: Removing the PCIe Mini Card Retention Screw	18
Figure 3-5: Inserting the PCIe Mini Card into the Slot at an Angle.....	19
Figure 3-6: Securing the PCIe Mini Card	19
Figure 3-7: Unlock SIM Card Slot Cover	21
Figure 3-8: Unlock SIM Card Slot Cover	21
Figure 3-9: SIM Card Installation.....	22
Figure 3-10: Lock SIM Card Slot Cover	22
Figure 3-11: M.2 Slot Location	23
Figure 3-12: Inserting the M.2 Module into the Slot at an Angle	23
Figure 3-13: Securing the M.2 Module.....	24
Figure 3-14: RJ-45 Ethernet Connector.....	27
Figure 3-15: AT/ATX Switch Location.....	28
Figure 3-16: DIN Rail Mounting Bracket Preparation.....	29
Figure 3-17: DIN Rail Mounting Bracket Installation.....	29
Figure 3-18: Attach the Mounting Bracket to the DIN Rail	30
Figure 3-19: Secure the Mounting Bracket	30
Figure 3-20: Power-on.....	32
Figure 3-21: IEI Resource Download Center.....	33
Figure 4-1: Clear CMOS Button Location.....	38
Figure 4-2: ME Override Jumper Location.....	39
Figure 6-1: Main Board Layout Diagram	81

List of Tables

Table 1-1: DRPC-230-ULT5 Model Variations	3
Table 1-2: Technical Specifications	7
Table 3-1: PCIe Mini Card Slot (MINI_PCIE1) Pinouts	20
Table 3-2: M.2 Module Slot (M2_A1) Pinouts	25
Table 3-3: RS-232/422/485 DB-9 Connector Pinouts	26
Table 3-4: RS-232 RJ-45 Connector Pinouts	26
Table 3-5: LAN Pinouts	27
Table 3-6: RJ-45 Ethernet Connector LEDs	27
Table 3-7: 3-pin Power Terminal Block Pinouts	31
Table 4-1: ME Override Jumper Settings	39
Table 5-1: BIOS Navigation Keys	42
Table 6-1: Peripheral Interface Connectors	82
Table 6-2: Battery Connector (BAT1) Pinouts	82
Table 6-3: Digital I/O Connector (DIO1) Pinouts	83
Table 6-4: Fan Connector (CPU/FAN1, CPU/FAN2) Pinouts	83
Table 6-5: Internal Power Connector (PWR1) Pinouts	83
Table 6-6: SATA 6Gb/s Connector (SATA1) Pinouts	84
Table 6-7: SMBus Connector (SMB1) Pinouts	84
Table 6-8: SPI Flash Connector (JSPI1) Pinouts	84
Table 6-9: TPM Connector (TPM1) Pinouts	85
Table 6-10: USB DOM Connector (DOM1) Pinouts	85

Chapter

1

Introduction

1.1 Overview



Figure 1-1: DRPC-230-ULT5 Series

The DRPC-230-ULT5 fanless embedded system is powered by the Intel® Core™ i5-8365UE processor. It is designed for harsh environment applications, and supports DIN rail mounting method.

The DRPC-230-ULT5 accepts a wide range of DC power input (12 V ~ 24 V), allowing it to be powered anywhere. It is equipped with six USB 3.2 Gen 2 (10Gb/s), three GbE, four RS-232/422/485, two RS-232 ports, one HDMI and one DisplayPort to provide rich I/O options for various applications.

Furthermore, the DRPC-230-ULT5 is possible to expand I/O through the second layer. Its expansion feature and modularized flexibility allows easy developing for AI inference and PoE applications. It is compatible with IEI's accelerator cards (Mustang-V100-MX8 or Mustang-V100-MX4) and PoE cards (GPOE-4P or GPOE-2P). An internal 60W power connector is reserved to provide power to PoE cards.

DRPC-230-ULT5 Embedded System

1.2 Model Variations

The model variations of the DRPC-230-ULT5 are listed below.

Model No.	PCIe x4 Expansion	Width
DRPC-230-ULT5-i5/8G/S	N/A	81 mm
DRPC-230-ULT5-i5/8G	Supports accelerator/PoE cards	127 mm

Table 1-1: DRPC-230-ULT5 Model Variations

1.3 Features

The DRPC-230-ULT5 features are listed below:

- Fanless design
- Intel® Core™ i5-8365UE processor 1.6 GHz (quad core, TDP 15W)
- Supports DDR4 SO-DIMM (system max. 32 GB)
- Supports one 2.5" SATA HDD/SSD
- Wide range DC power input (12 V ~ 24 V)
- Extended temperature fanless design supports -20°C ~ 60°C
- Triple GbE port
- Four RS-232/422/485 and two RS-232 serial interfaces
- Six USB 3.2 Gen 2 (10Gb/s)
- Flexible modularized expansion
- Low power consumption
- DIN rail mounting support
- RoHS compliant

1.4 Front Panel

The DRPC-230-ULT5 front panel contains:

- 3 x RJ-45 Gigabit LAN ports
- 4 x RS-232/422/485 serial ports (DB-9)
- 2 x RS-232 serial ports (RJ-45)
- 6 x USB 3.2 Gen 2 (10Gb/s) ports
- 1 x Power LED (green)
- 1 x HDD LED (yellow)

The overview of the front panel is shown in **Figure 1-2**.

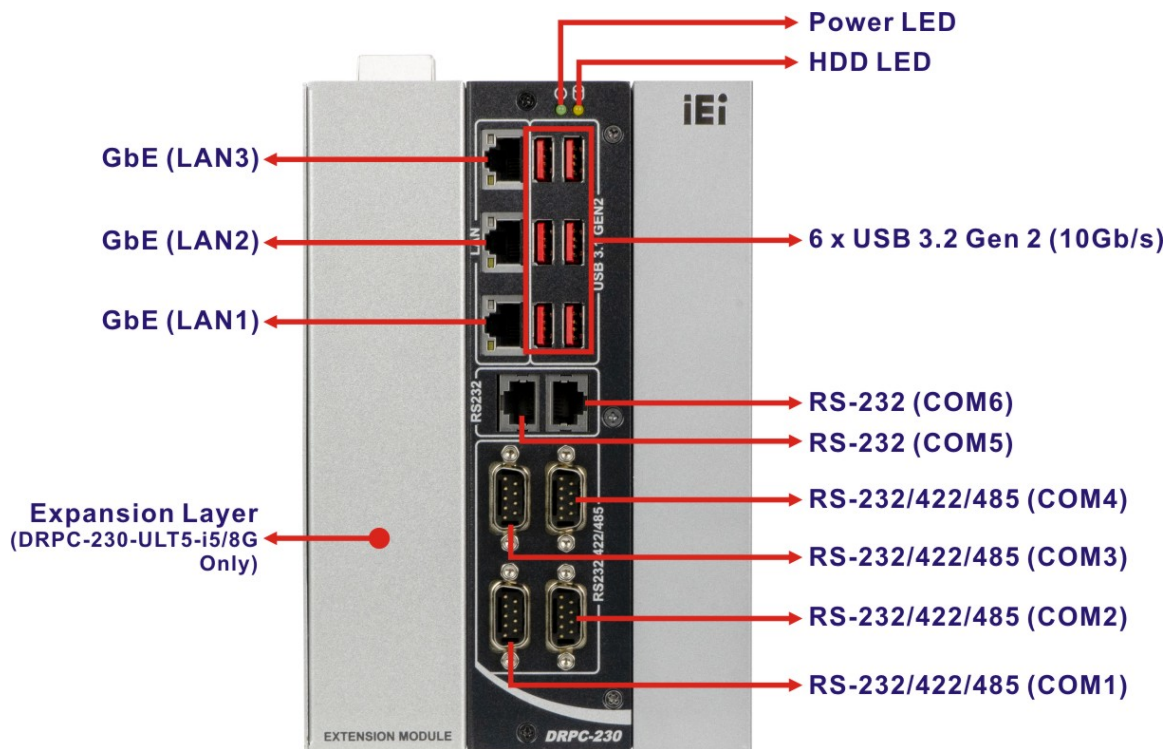

Figure 1-2: Front Panel

DRPC-230-ULT5 Embedded System

1.5 Top Panel

The DRPC-230-ULT5 top panel contains:

- 1 x 12 V ~ 24 V DC power terminal block
- 1 x Earth ground connector
- 1 x HDMI connector
- 1 x DisplayPort connector
- 1 x Power button
- 1 x Reset button
- 1 x AT/ATX power switch

An overview of the top panel is shown in **Figure 1-3** below.

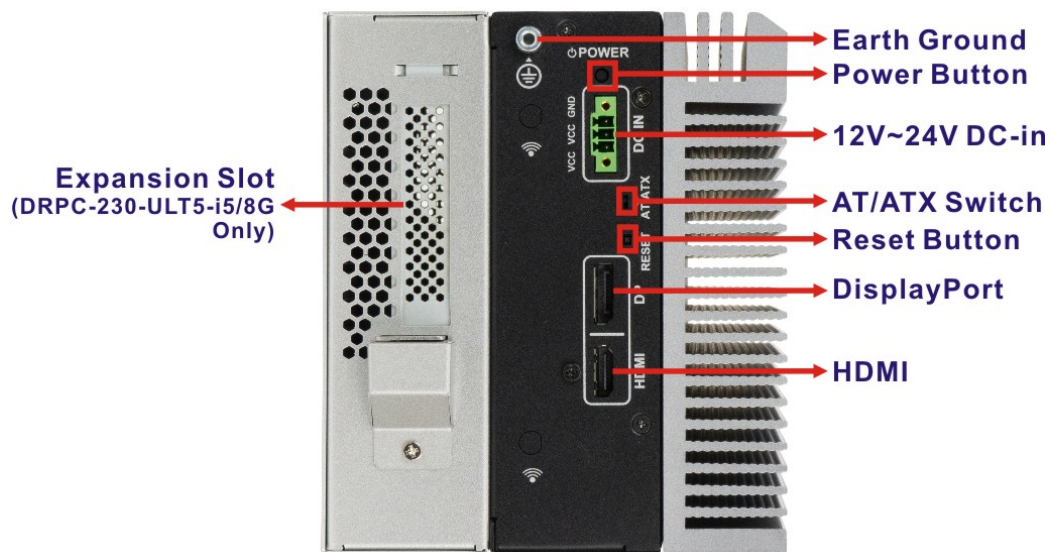

Figure 1-3: Top Panel

1.6 Technical Specifications

The DRPC-230-ULT5 technical specifications are listed in **Table 1-2**.

System	
CPU (SoC)	Intel® Core™ i5-8365UE processor (1.6 GHz, quad core, TDP=15W)
Memory	Two 260-pin 2400 MHz DDR4 SO-DIMM slots (pre-installed with one 8 GB memory module, system max. 32 GB)
Ethernet Controller	2 x Intel® I210 GbE controller (colay Intel® I211) 1 x Intel® I219 GbE PHY
Wireless	802.11a/b/g/n/ac (optional)
Watchdog Timer	Software programmable, support 1~255 sec. system reset
Supported OS	Microsoft Windows 10 / Linux
Storage	One 2.5" SATA 6Gb/s HDD/SSD bay
I/O and Indicators	
Ethernet	3 x RJ-45 ports
COM Port	4 x RS-232/422/485 with AFC (DB-9) 2 x RS-232 (RJ-45)
USB	6 x USB 3.2 Gen 2 (10Gb/s) ports (external) 1 x USB 2.0 pin-header (internal, for QTS Gateway)
Display	1 x HDMI (lockable) 1 x DisplayPort
Digital I/O	8-bit (by internal pin-header)
SIM	1 x Internal on-board SIM slot (A WWAN module must be installed in the PCIe Mini slot to provide WWAN communication.)
TPM	1 x TPM 2.0 (2x10 pin)
LED Indicators	1 x HDD LED (yellow) 1 x Power LED (green)

DRPC-230-ULT5 Embedded System

Button/Switch	Power button, Reset button, AT/ATX power switch
Interior Expansion	
PCIe Mini	1 x Full-size (PCIe/USB 3.0/SATA) 1 x Full-size (USB 2.0, via PCIe x4 slot)
M.2	1 x M.2 2230 A-Key (PCIe/USB 2.0) 1 x M.2 2280 M-Key (PCIe x4, via PCIe x4 slot)
Power	
Power Input	One power connector (3-pin terminal block) 12 V ~ 24 V DC *Reserved internal 60W power connector for expansion cards
AT/ATX Mode	AT/ATX switch
Power Consumption	12 V @ 4.98 A
Environmental and Mechanical	
Mounting	DIN rail
Operating Temperature	-20°C~60°C
Storage Temperature	-40°C~85°C
Operating Humidity	10%~95%, non-condensing
Storage Humidity	10%~90%, non-condensing
Chassis Construction	Extruded aluminum alloy for fanless support
Operating Shock	Half-sine shock test 5G/11ms, 100 shocks per axis, IEC68-2-27
Operating Vibration	MIL-STD-810G 514.6C-1 (SSD)
Safety	CE/FCC
Weight (Net/Gross)	DRPC-230-ULT5/S: 2.9 kg / 3.2 kg DRPC-230-ULT5: 3.2 kg / 3.5 kg
Physical Dimensions (W x D x H)	DRPC-230-ULT5/S: 81 mm x 150 mm x 190 mm DRPC-230-ULT5: 127 mm x 150 mm x 190 mm

Table 1-2: Technical Specifications

1.7 Dimensions

The physical dimensions of the DRPC-230-ULT5 series are shown below.

1.7.1 DRPC-230-ULT5-i5/8G/S Dimensions

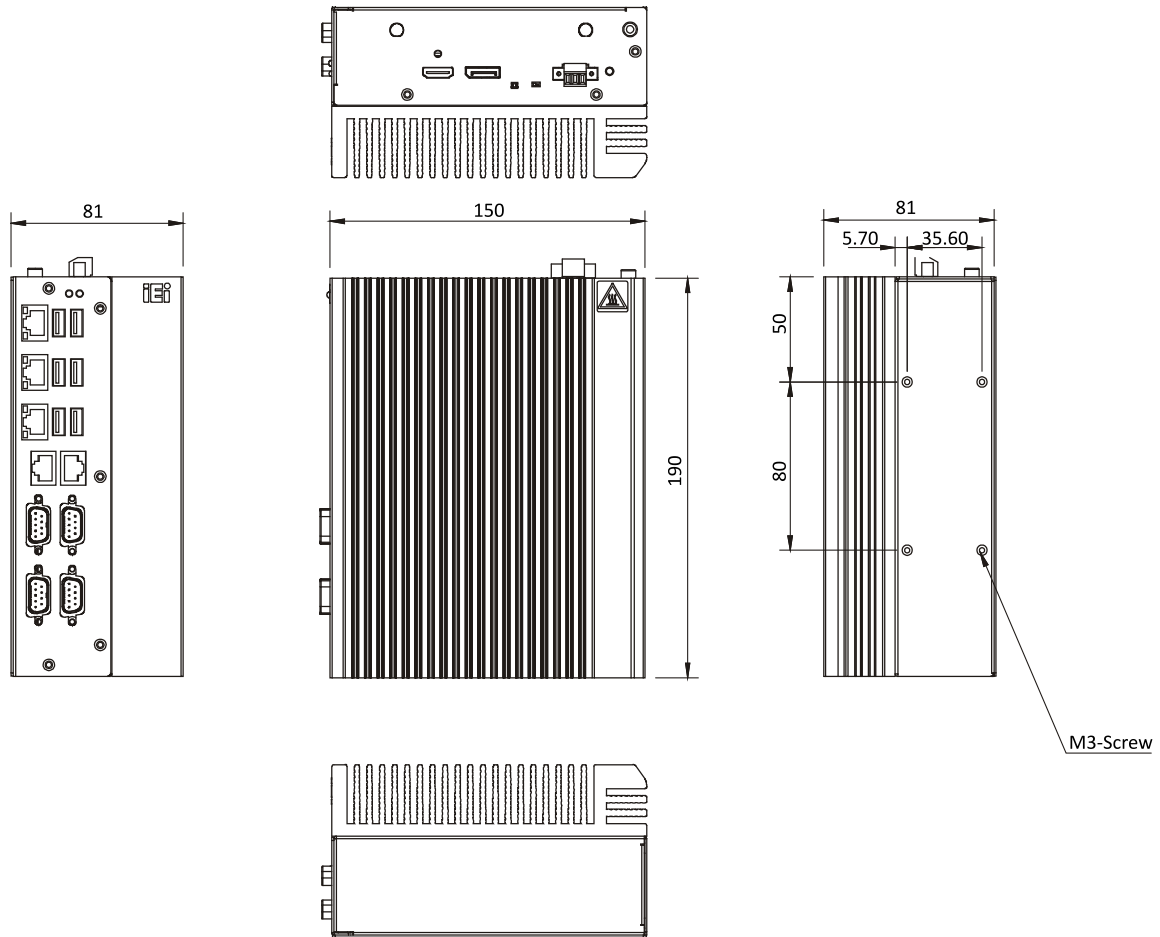

Figure 1-4: DRPC-230-ULT5-i5/8G/S Dimensions (mm)

DRPC-230-ULT5 Embedded System

1.7.2 DRPC-230-ULT5-i5/8G Dimensions

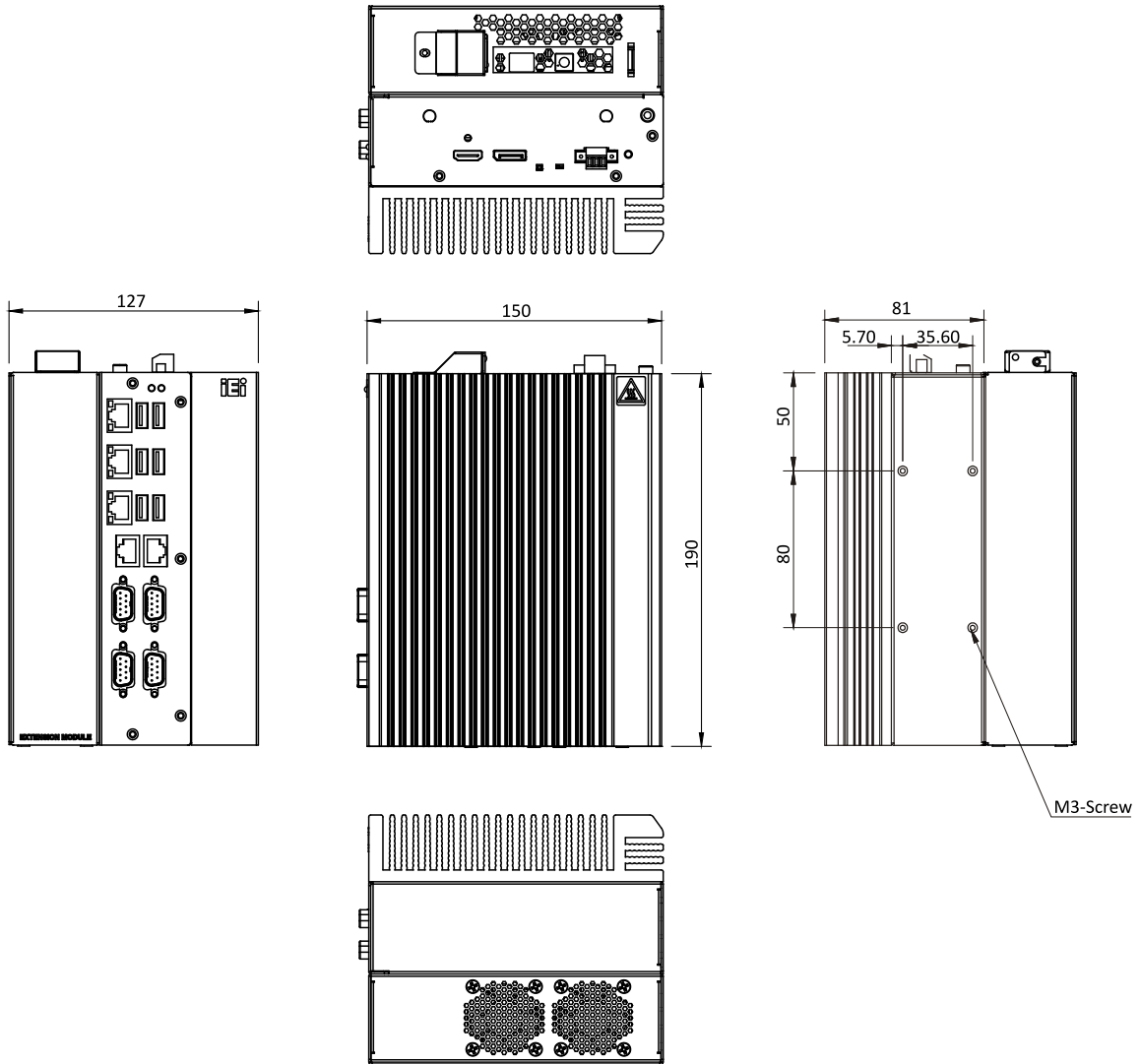

Figure 1-5: DRPC-230-ULT5-i5/8G Dimensions (mm)

Chapter

2

Unpacking

DRPC-230-ULT5 Embedded System

2.1 Anti-static Precautions



WARNING:

Failure to take ESD precautions during installation may result in permanent damage to the DRPC-230-ULT5 and severe injury to the user.

Electrostatic discharge (ESD) can cause serious damage to electronic components, including the DRPC-230-ULT5. Dry climates are especially susceptible to ESD. It is therefore critical that whenever the DRPC-230-ULT5 or any other electrical component is handled, the following anti-static precautions are strictly adhered to.

- ***Wear an anti-static wristband:*** Wearing a simple anti-static wristband can help to prevent ESD from damaging the board.
- ***Self-grounding:*** Before handling the board, touch any grounded conducting material. During the time the board is handled, frequently touch any conducting materials that are connected to the ground.
- ***Use an anti-static pad:*** When configuring the DRPC-230-ULT5, place it on an anti-static pad. This reduces the possibility of ESD damaging the DRPC-230-ULT5.

2.2 Unpacking Precautions

When the DRPC-230-ULT5 is unpacked, please do the following:

- Follow the anti-static precautions outlined in **Section 2.1**.
- Make sure the packing box is facing upwards so the DRPC-230-ULT5 does not fall out of the box.
- Make sure all the components shown in **Section 2.3** are present.





2.3 Packing List



NOTE:

If some of the components listed in the checklist below are missing, please do not proceed with the installation. Contact the IEI reseller or vendor you purchased the DRPC-230-ULT5 from or contact an IEI sales representative directly. To contact an IEI sales representative, please send an email to sales@ieiworld.com.









The DRPC-230-ULT5 is shipped with the following components:

Quantity	Item and Part Number	Image
Standard		
1	DRPC-230-ULT5	
1	DIN rail mounting kit	
1	M4*6 screw for earth grounding	
4	M3*4 screws (for securing HDD)	

DRPC-230-ULT5 Embedded System

2.4 Optional Items

The following table lists the optional items that can be purchased separately.

Optional	
Power adapter, 96 W (P/N: 63040-010096-230-RS)	
Power cable, DC jack to 3-pin terminal block, 200 mm (P/N: 32102-026500-100-RS)	
Wireless kit (P/N: EMB-WIFI-KIT01-R20)	
20-pin Infineon TPM 2.0 module, software management tool, firmware v5.5 (P/N: TPM-IN02-R20)	
Mustang-V100-MX8 accelerator card	
Mustang-V100-MX4 accelerator card	
GPOE-4P-R20 PoE card	
GPOE-2P-R20 PoE card	

Chapter

3

Installation

DRPC-230-ULT5 Embedded System

3.1 Installation Precautions

During installation, be aware of the precautions below:

- **Read the user manual:** The user manual provides a complete description of the DRPC-230-ULT5, installation instructions and configuration options.
- **DANGER! Disconnect Power:** Power to the DRPC-230-ULT5 must be disconnected during the installation process. Failing to disconnect the power may cause severe injury to the body and/or damage to the system.
- **Qualified Personnel:** The DRPC-230-ULT5 must be installed and operated only by trained and qualified personnel. Maintenance, upgrades, or repairs may only be carried out by qualified personnel who are familiar with the associated dangers.
- **Air Circulation:** Make sure there is sufficient air circulation when installing the DRPC-230-ULT5. The DRPC-230-ULT5's cooling vents must not be obstructed by any objects. Blocking the vents can cause overheating of the DRPC-230-ULT5. Leave at least 5 cm of clearance around the DRPC-230-ULT5 to prevent overheating.
- **Grounding:** The DRPC-230-ULT5 should be properly grounded. The voltage feeds must not be overloaded. Adjust the cabling and provide external overcharge protection per the electrical values indicated on the label attached to the back of the DRPC-230-ULT5.

3.1.1 High Surface Temperature



WARNING:

Some surfaces of the equipment may become hot during operation.

The surface temperature may be up to several tens of degrees hotter than the ambient temperature. Under these circumstances, the equipment needs to be protected against accidental contact.

The equipment is intended for installation in a RESTRICTED ACCESS LOCATION.

- Access can only be gained by SERVICE PERSONS or by USERS who have been instructed about the reasons for the restrictions applied to the location and about any precautions that shall be taken.
- Access is through the use of a TOOL or lock and key, or other means of security, and is controlled by the authority responsible for the location.

3.2 Internal Access Panel Removal

Before installing or maintaining the internal components, the internal access panel must be removed from the DRPC-230-ULT5. Follow the steps below to complete the task.

Step 1: Remove the six retention screws indicated in **Figure 3-1**.

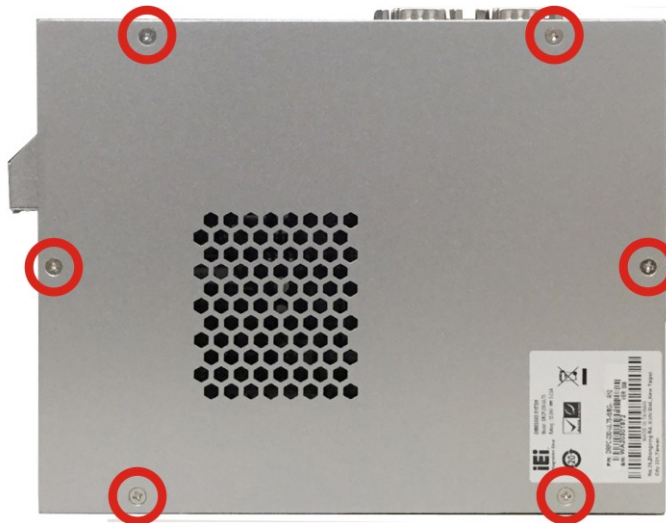

Figure 3-1: Internal Access Panel Retention Screws

Step 2: Lift the panel to remove it from the chassis.



NOTE:

The vent on the panel is designed for dissipating heat from the installed PCIe x4 expansion card, so the S model does not have the ventilation holes on this panel.

DRPC-230-ULT5 Embedded System

3.3 HDD Installation



WARNING:

Please install a solid state drive (SSD) when the DRPC-230-ULT5 is used in a harsh environment with extreme shock and vibration.

The DRPC-230-ULT5 allows installation of one 2.5" HDD/SSD. To install a HDD into the system, please follow the steps below.

- Step 1:** Remove the internal access panel from the DRPC-230-ULT5. Please follow the instruction described in **Section 3.2**.
- Step 2:** Install the HDD into the bracket on the internal access panel, and secure the HDD with four M3*4 retention screws (**Figure 3-2**).
- Step 3:** Connect the SATA cable from the motherboard to the rear of the HDD (**Figure 3-2**).



Figure 3-2: HDD Installation

- Step 4:** Replace and secure the internal access panel to the system.

3.4 PCIe Mini Card Installation

The DRPC-230-ULT5 has one full-size PCIe Mini slot (MINI_PCIE1) on the motherboard for mSATA SSD or WWAN module installation. To install a full-size PCIe Mini module, follow the instructions below.

Step 1: Remove the internal access panel from the DRPC-230-ULT5. See **Section 3.2**.

Step 2: Locate the PCIe Mini slot on the motherboard (**Figure 3-3**).

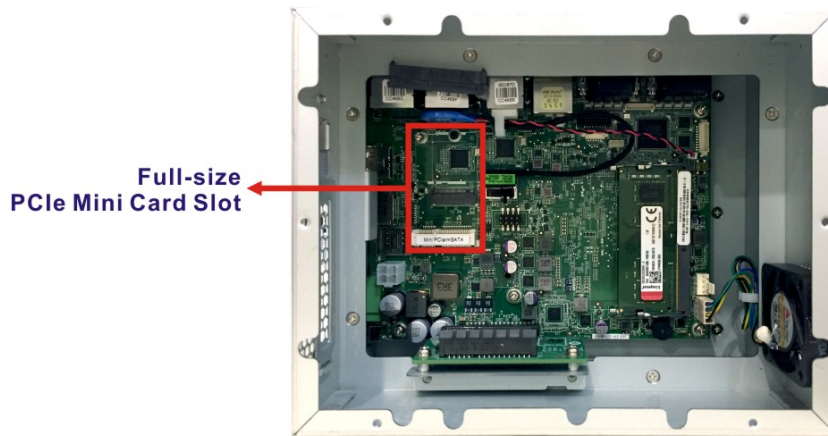

Figure 3-3: PCIe Mini Slot Location

Step 3: Remove the retention screw as shown in **Figure 3-4**.

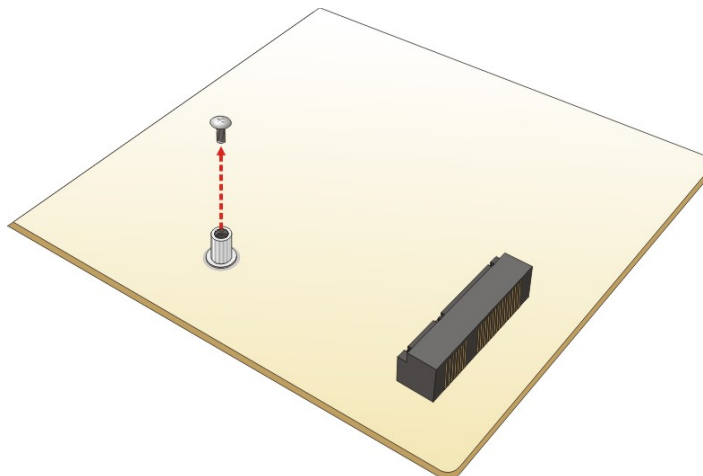

Figure 3-4: Removing the PCIe Mini Card Retention Screw

DRPC-230-ULT5 Embedded System

Step 4: Line up the notch on the card with the notch on the slot. Slide the PCIe Mini card into the socket at an angle of about 20° (**Figure 3-5**).

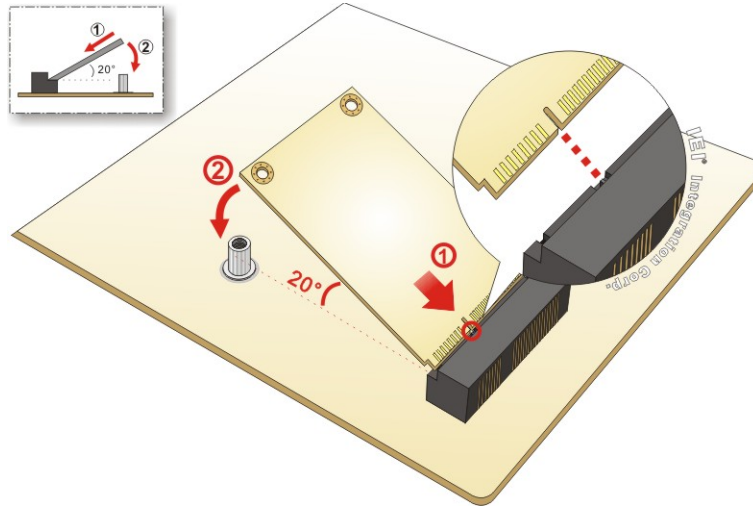

Figure 3-5: Inserting the PCIe Mini Card into the Slot at an Angle

Step 5: Secure the PCIe Mini card with the retention screw previously removed (**Figure 3-6**).

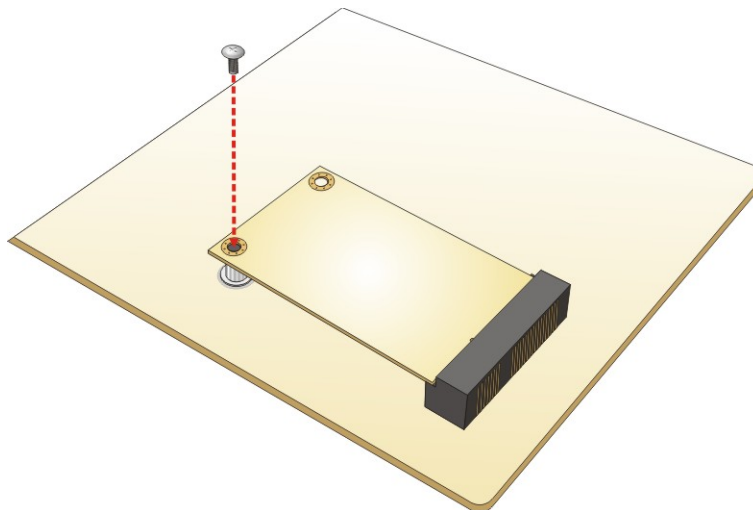

Figure 3-6: Securing the PCIe Mini Card

3.4.1 PCIe Mini Card Slot Pinouts (MINI_PCIE1)

The MINI_PCIE1 slot supports USB, SATA and PCIe signal for installing mSATA or WWAN modules.

PIN NO.	DESCRIPTION	PIN NO.	DESCRIPTION
1	PCIE_WAKE#	2	VCC3
3	N/C	4	GND
5	N/C	6	1.5V
7	N/C	8	UIM_PWR
9	GND	10	UIM_DATA
11	PCIE_CLK#	12	UIM_CLK
13	PCIE_CLK	14	UIM_RST
15	GND	16	UIM_VPP
17	N/C	18	GND
19	N/C	20	N/C
21	GND	22	PCIRST#
23	PCIE_RXN	24	N/C
25	PCIE_RXP	26	GND
27	GND	28	1.5V
29	GND	30	SMBCLK
31	PCIE_TXN	32	SMBDATA
33	PCIE_TXP	34	GND
35	GND	36	USB D-
37	GND	38	USB D+
39	VCC3	40	GND
41	VCC3	42	N/C
43	GND	44	N/C
45	N/C	46	N/C
47	N/C	48	1.5V
49	N/C	50	GND
51	N/C	52	VCC3

Table 3-1: PCIe Mini Card Slot (MINI_PCIE1) Pinouts

DRPC-230-ULT5 Embedded System

3.5 SIM Card Installation

**NOTE:**

A WWAN module must be installed in the PCIe Mini slot (MINI_PICE1) to provide WWAN communication.

To install a SIM card, please follow the steps below.

Step 1: Locate the SIM card slot (Figure 3-7).

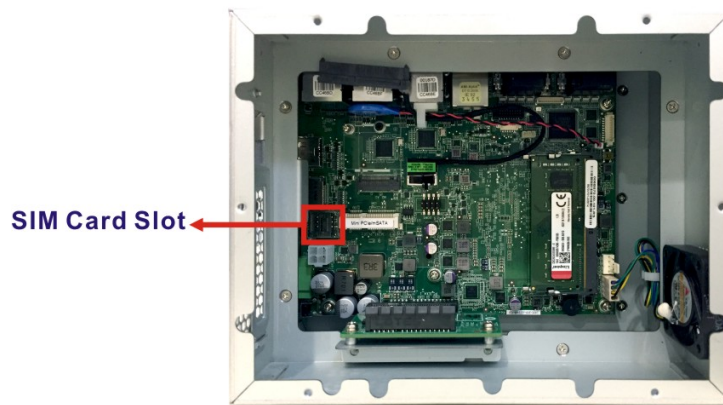

Figure 3-7: Unlock SIM Card Slot Cover

Step 2: Unlock the SIM card slot cover by sliding the cover in the direction as shown by the arrow in Figure 3-8.

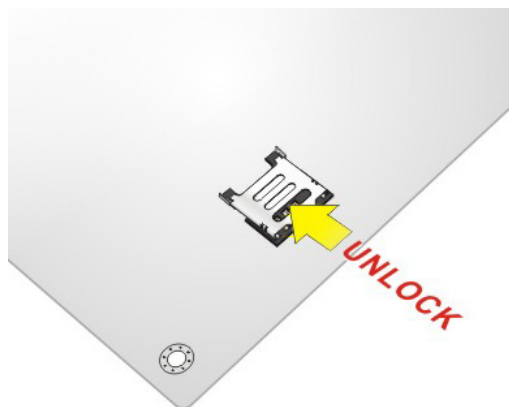

Figure 3-8: Unlock SIM Card Slot Cover

Step 3: Open the slot cover and place a SIM card onto the slot. The cut mark on the corner should be facing away from the slot as shown in **Figure 3-9**.

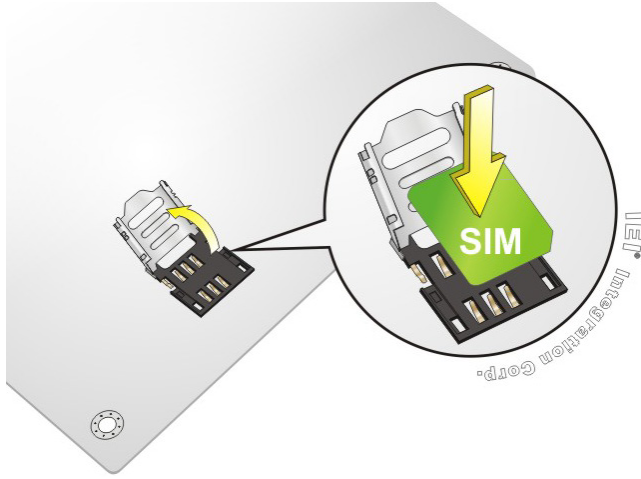

Figure 3-9: SIM Card Installation

Step 4: Close the slot cover and lock it by sliding it in the direction as shown by the arrow in **Figure 3-10**.



Figure 3-10: Lock SIM Card Slot Cover

DRPC-230-ULT5 Embedded System

3.6 M.2 Module Installation

The DRPC-230-ULT5 has one M.2 2230 A-key slot on the motherboard. To install a M.2 module, follow the instructions below.

Step 1: Remove the internal access panel from the DRPC-230-ULT5. See **Section 3.2**.

Step 2: Locate the M.2 slot on the motherboard (**Figure 3-11**). Remove the on-board retention screw.

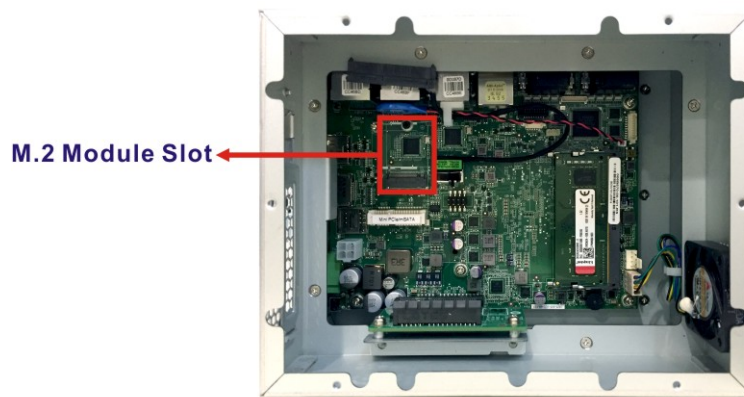

Figure 3-11: M.2 Slot Location

Step 3: Line up the notch on the module with the notch on the slot. Slide the M.2 module into the socket at an angle of about 20° (**Figure 3-12**).

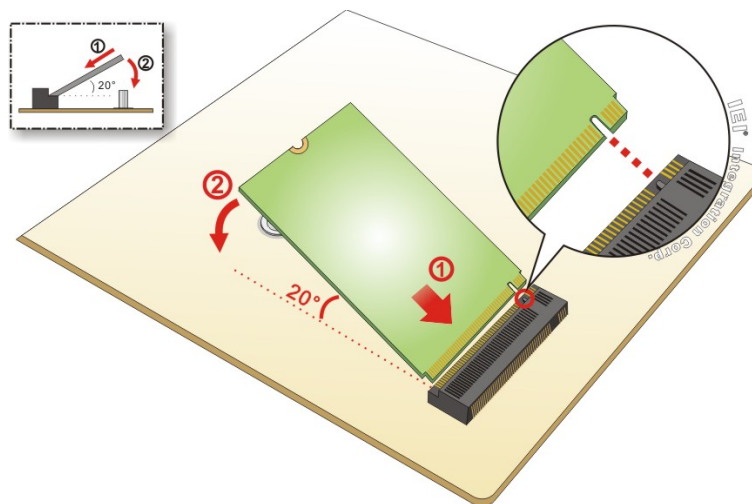

Figure 3-12: Inserting the M.2 Module into the Slot at an Angle

Step 4: Secure the M.2 module with the retention screw removed previously
(Figure 3-13).

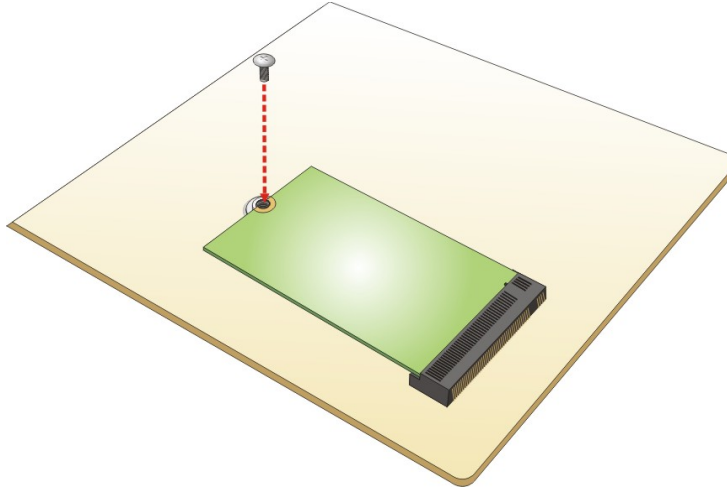

Figure 3-13: Securing the M.2 Module

3.6.1 M.2 Module Slot Pinouts (M2_A1)

The M2_A1 slot supports USB 2.0 and PCIe signal for installing a variety of M.2 2230 A-key modules.

PIN NO.	DESCRIPTION	PIN NO.	DESCRIPTION
1	GND	2	+V3.3A
3	USB+	4	+V3.3A
5	USB-	6	NC
7	GND	8	Module Key
9	Module Key	10	Module Key
11	Module Key	12	Module Key
13	Module Key	14	Module Key
15	Module Key	16	NC
17	NC	18	GND
19	NC	20	NC
21	NC	22	NC
23	GND	24	GND
25	NC	26	NC

DRPC-230-ULT5 Embedded System

PIN NO.	DESCRIPTION	PIN NO.	DESCRIPTION
27	NC	28	NC
29	GND	30	GND
31	NC	32	NC
33	GND	34	NC
35	PCIE_TX0+	36	GND
37	PCIE_TX0-	38	NC
39	GND	40	NC
41	PCIE_RX0+	42	NC
43	PCIE_RX0-	44	NC
45	GND	46	NC
47	CLK_PCIE0+	48	NC
49	CLK_PCIE0-	50	NC
51	GND	52	BUF_PLT_RST#
53	PCIE_CLKREQ#	54	Pull Up +V3.3A
55	PCIE_WAKE#	56	Pull Up +V3.3A
57	GND	58	NC
59	NC	60	NC
61	NC	62	NC
63	GND	64	NC
65	NC	66	NC
67	NC	68	NC
69	GND	70	NC
71	NC	72	+V3.3A
73	NC	74	+V3.3A

Table 3-2: M.2 Module Slot (M2_A1) Pinouts

3.7 RS-232/422/485 Serial Port Connection

The DRPC-230-ULT5 has four D-sub 9 male connectors for RS-232/422/485 connection. The pinouts of the D-sub 9 connectors are listed below. The RS-232/422/485 mode can be configured through BIOS (refer to **Section 5.3.7**); the default setting is RS-232 mode.

PIN NO.	RS-232	RS-422	RS-485
1	DCD	TX-	TX-
2	RX	TX+	TX+
3	TX	RX+	
4	DTR	RX-	
5	GND		
6	DSR		
7	RTS		
8	CTS		
9	RI		

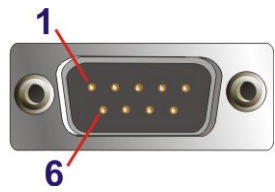

Table 3-3: RS-232/422/485 DB-9 Connector Pinouts

3.8 RS-232 Serial Port Connection

The DRPC-230-ULT5 has two RJ-45 connectors for RS-232 connection. The pinouts of the RJ-45 connectors are listed below.

PIN NO.	RS-232
1	RING INDICATOR (RI)
2	DATA TERMINAL READY (DTR)
3	CLEAR TO SEND (CTS)
4	TRANSMIT DATA (TXD)
5	REQUEST TO SEND (RTS)
6	RECEIVE DATA (RXD)
7	DATA SET READY (DSR)
8	DATA CARRIER DETECT (DCD)

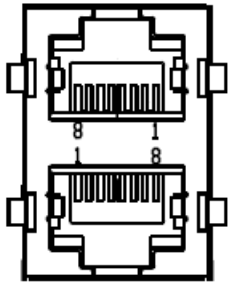

Table 3-4: RS-232 RJ-45 Connector Pinouts

DRPC-230-ULT5 Embedded System

3.9 LAN Connection

The LAN connectors allow connection to an external network.

Pin	Description	Pin	Description
1	LAN_MDI0P	5	LAN_MDI2P
2	LAN_MDI0N	6	LAN_MDI2N
3	LAN_MDI1P	7	LAN_MDI3P
4	LAN_MDI1N	8	LAN_MDI3N

Table 3-5: LAN Pinouts

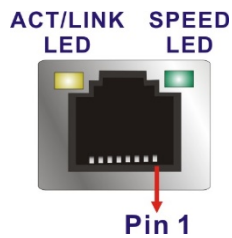

Figure 3-14: RJ-45 Ethernet Connector

The RJ-45 Ethernet connector has two status LEDs, one green and one yellow. The green LED indicates activity on the port and the yellow LED indicates the port is linked. See **Table 3-6**.

Activity/Link LED		Speed LED	
STATUS	DESCRIPTION	STATUS	DESCRIPTION
Off	No link	Off	10 Mbps connection
Yellow	Linked	Green	100 Mbps connection
Blinking	TX/RX activity	Orange	1 Gbps connection

Table 3-6: RJ-45 Ethernet Connector LEDs

3.10 AT/ATX Mode Selection

AT and ATX power modes can both be used on the DRPC-230-ULT5. The selection is made through an AT/ATX switch on the top panel as shown below (**Figure 3-15**).

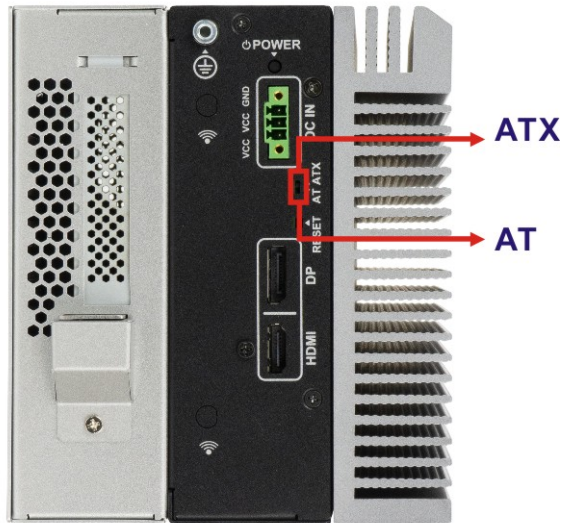

Figure 3-15: AT/ATX Switch Location

DRPC-230-ULT5 Embedded System

3.11 DIN Rail Mounting

To mount the DRPC-230-ULT5 onto a DIN rail, please follow the steps below.

Step 1: Prepare the DIN rail mounting bracket by sliding the small metal block into the slot of the bracket as shown below.

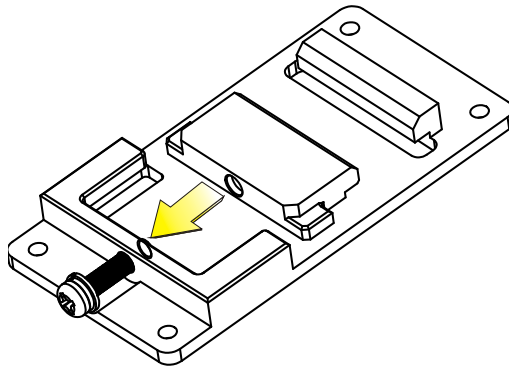

Figure 3-16: DIN Rail Mounting Bracket Preparation

Step 2: Attach the mounting bracket to the rear panel of the DRPC-230-ULT5. Secure the bracket with four M3*6 retention screws (Figure 3-17).

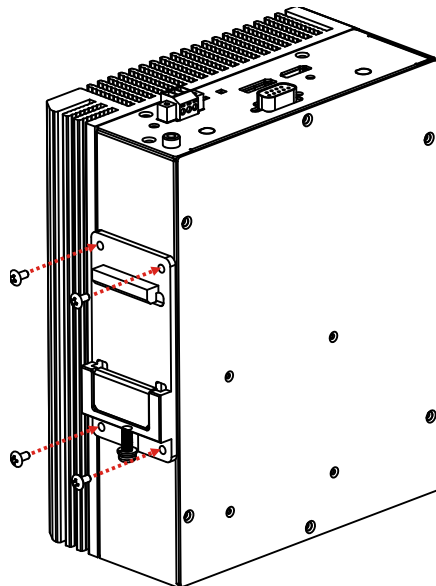

Figure 3-17: DIN Rail Mounting Bracket Installation



NOTE:

In the diagrams below, the DIN rail is already installed on a surface or on a chassis.

Step 3: Attach the upper edge of the mounting bracket to the DIN rail as shown in **Figure 3-18**.

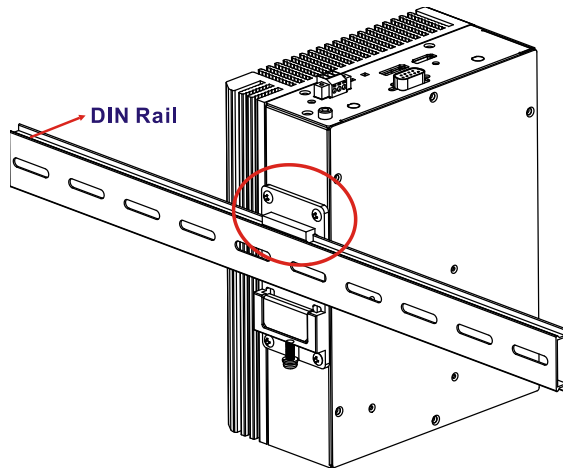

Figure 3-18: Attach the Mounting Bracket to the DIN Rail

Step 4: Use a screwdriver to rotate the screw of the mounting bracket until the small metal block can firmly secure the system to the DIN rail. (**Figure 3-19**).

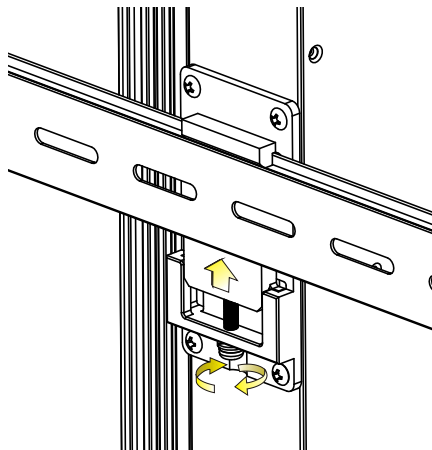

Figure 3-19: Secure the Mounting Bracket

DRPC-230-ULT5 Embedded System

3.12 Power-On Procedure

3.12.1 Installation Checklist



WARNING:

Make sure a power supply with the correct input voltage is being fed into the system. Incorrect voltages applied to the system may cause damage to the internal electronic components and may also cause injury to the user.

To power on the embedded system please make sure of the following:

- The internal access panel is installed
- All peripheral devices (monitor, serial communications devices etc.) are connected
- The system is securely mounted

3.12.2 Terminal Block Pinouts

The DRPC-230-ULT5 model has a 12 V – 24 V power input terminal block. The terminal block pinouts are shown below. Make sure that the power and ground wires are attached to the correct sockets of the connector.

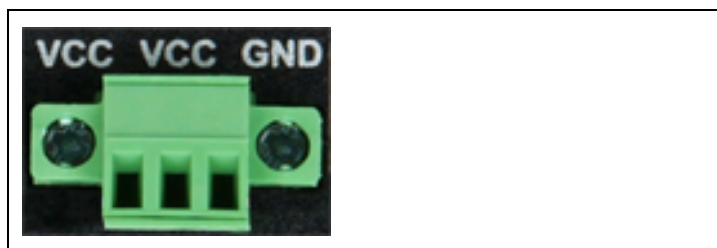

Table 3-7: 3-pin Power Terminal Block Pinouts

3.12.3 Power-on Procedure

To power-on the DRPC-230-ULT5 please follow the steps below:

- Step 1:** Connect the power source to the power input terminal block.
- Step 2:** Use the M4*6 screw that came with the package to secure the grounding cable with the grounding connector on the top panel of the DRPC-230-ULT5.
- Step 3:** ATX mode (default): Long press the power button for around 5 seconds until the power LED turns to green.
AT mode: The system turns on automatically.

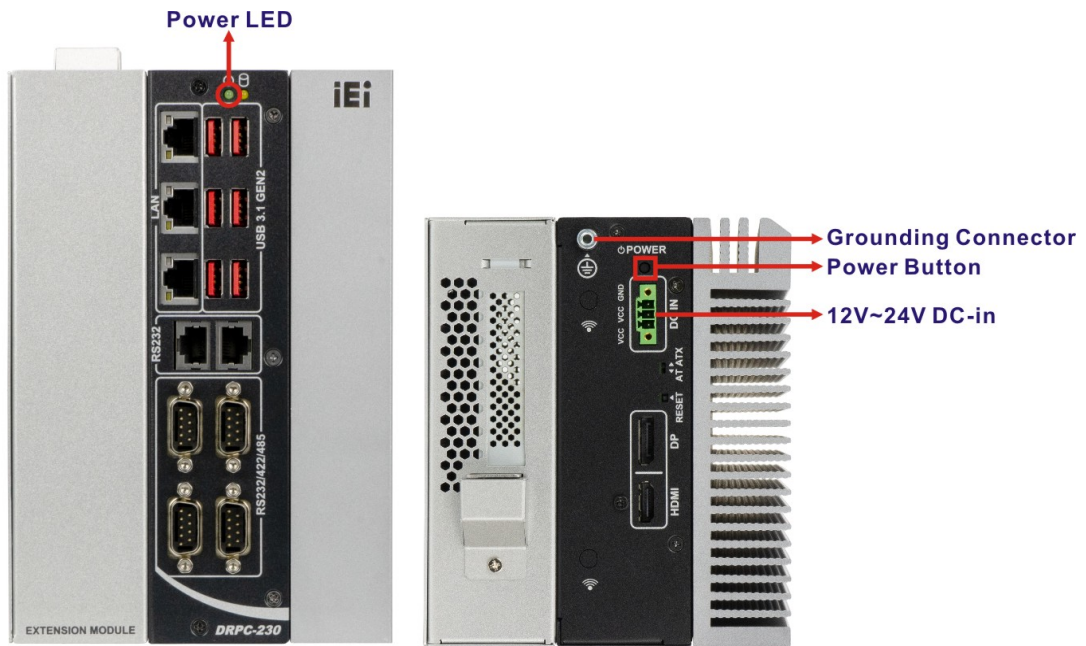

Figure 3-20: Power-on

DRPC-230-ULT5 Embedded System

3.13 Available Drivers

All the drivers for the DRPC-230-ULT5 are available on IEI Resource Download Center (<https://download.ieiworld.com>). Type DRPC-230-ULT5 and press Enter to find all the relevant software, utilities, and documentation.

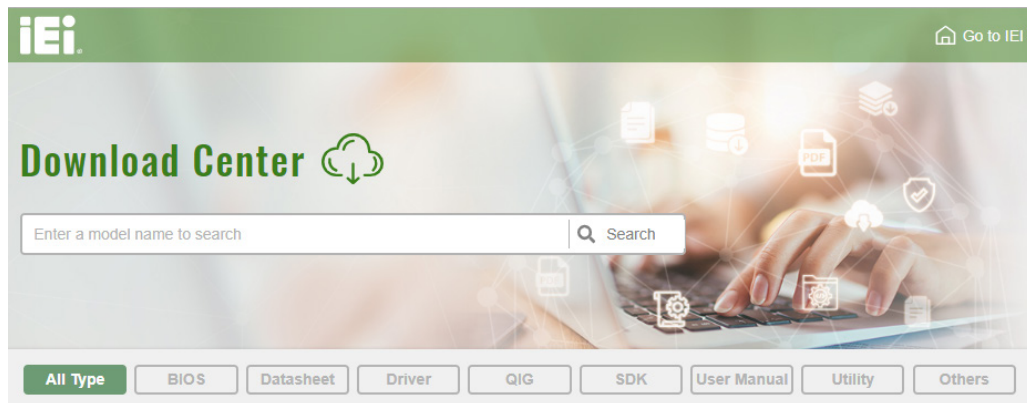
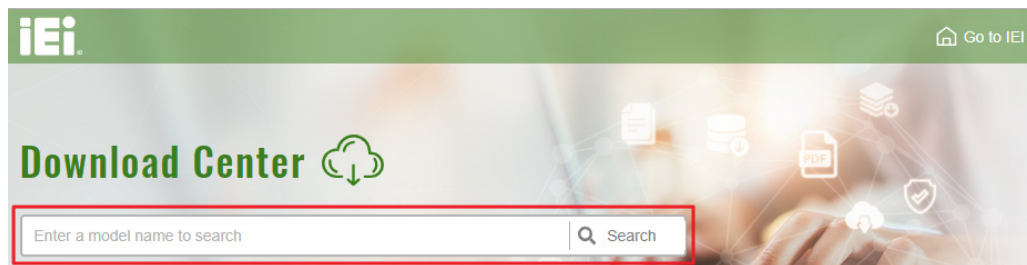

Figure 3-21: IEI Resource Download Center

3.13.1 Driver Download

To download drivers from IEI Resource Download Center, follow the steps below.

Step 1: Go to <https://download.ieiworld.com>. Type DRPC-230-ULT5 and press Enter.



Step 2: All product-related software, utilities, and documentation will be listed. You can choose **Driver** to filter the result.

[All Type](#)
[BIOS](#)
[Datasheet](#)
[Driver](#)
[QIG](#)
[SDK](#)
[User Manual](#)
[Utility](#)
[Others](#)

WAFER-BT-i1 [Product Info](#)

[Embedded Computer](#) > [Single Board Computer](#) > [Embedded Board](#)
 3.5" SBC with Intel® 22nm Atom™/Celeron® on-board SoC

Driver

File Name	Published	Version	File Checksum
7B000-001033-RS V2.3.iso (2.23 GB)	2017/10/03	2.30	3B2DB1F792779A93A8F50DDBC3943E30

Step 3: Click the driver file name on the page and you will be prompted with the following window. You can download the entire ISO file (❶), or click the small arrow to find an individual driver and click the file name to download (❷).

7B000-001168-RS_V1.4.iso

❶ [Click here to download entire ISO file. \(2.99 GB\)](#)

* Download individual file *

- Docs
 - 1. Chipset
 - 10.1.1.12.zip (2.7 MB)
 - 2. VGA
 - 3. Audio
 - 4. Lan
 - 5. USB 3.0
 - 6. Serial IO
 - 7. TXE
 - 8. Manual

❷



NOTE:

To install software from the downloaded ISO image file in Windows 10, double-click the ISO file to mount it as a virtual drive to view its content.

Chapter

4

Troubleshooting and Maintenance

**WARNING:**

Take Anti-Static precautions whenever maintenance is being carried out on the system components. Failure to take anti-static precautions can cause permanent system damage. For more details on anti-static precautions, please refer to **Section 2.1**.

4.1 System Maintenance Overview

**NOTE:**

When doing maintenance operations on the system, please follow the instructions in this chapter. Failure to follow these instructions may lead to personal injury and system damage.

To preserve the working integrity of the DRPC-230-ULT5 embedded system, the system must be properly maintained. If embedded system components need replacement, the proper maintenance procedures must be followed to ensure the system can continue to operate normally.

4.2 System Troubleshooting

This section provides some simple troubleshooting suggestions.

4.2.1 The System Doesn't Turn On

If after turning the system on, there is no power (indicated by the power LED on the front panel not turning on) please do the following:

- Step 1:** Check that the power cable connector is properly connected to the system rear panel.
- Step 2:** Check that the power cable connector is properly plugged into the power source.

DRPC-230-ULT5 Embedded System

Step 3: Make sure the power button is turned on.

Step 4: Plug the system into a monitor and check to see if anything appears on the screen. If the boot-up screen appears it means the power LED has failed. To fix this problem, contact an IEI sales representative directly.

4.2.2 The System Doesn't Boot Up

If the system doesn't boot up please do the following:

Step 1: Check the power is turned on. See **Section 4.2.1** above.

Step 2: Make sure the SO-DIMM modules are properly installed.

4.2.3 More Troubleshooting

Nothing appears on the monitor after booting up the system: Make sure the monitor is properly connected to the system and the monitor is connected to a power supply and turned on.



WARNING:

If all troubleshooting measures have been taken and the system still fails to start, contact the IEI reseller or vendor you purchased the DRPC-230-ULT5 from or contact an IEI sales representative directly. To contact an IEI sales representative, please send an email to sales@ieiworld.com.

4.3 Maintenance

To configure the jumper settings, please follow the steps below.

Step 1: Remove the internal access panel. See **Section 3.2**.

Step 2: Locate the jumper/button on the embedded motherboard.

Step 3: Make the jumper settings in accordance with the settings described and defined in the following sections.

4.3.1 Clear CMOS

If the DRPC-230-ULT5 fails to boot due to improper BIOS settings, the clear CMOS button clears the CMOS data and resets the system BIOS information. To do this, push the clear CMOS button for a few seconds.

If the “CMOS Settings Wrong” message is displayed during the boot up process, the fault may be corrected by pressing the F1 to enter the CMOS Setup menu. Do one of the following:

- Enter the correct CMOS setting
- Load Optimal Defaults
- Load Failsafe Defaults.

After having done one of the above, save the changes and exit the CMOS Setup menu.

The clear CMOS button location is shown in **Figure 4-1** below.

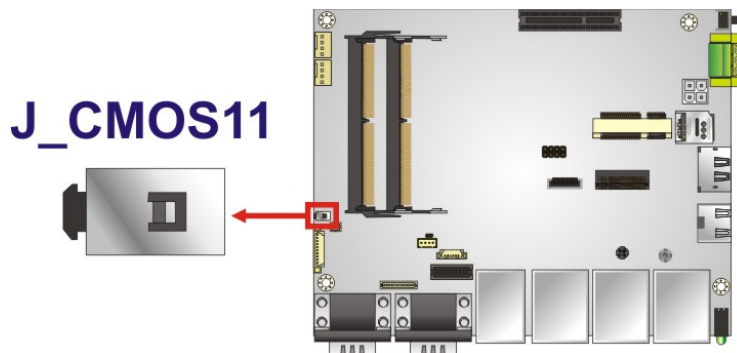

Figure 4-1: Clear CMOS Button Location

DRPC-230-ULT5 Embedded System

4.3.2 ME Override Jumper

The ME Override jumper (ME_FLASH1) allows users to enable or disable the ME firmware update. Refer to **Figure 4-2** and **Table 4-1** for the jumper location and settings.

Setting	Description
Open	Disabled (default)
Short	Enabled

Table 4-1: ME Override Jumper Settings

ME_FLASH1

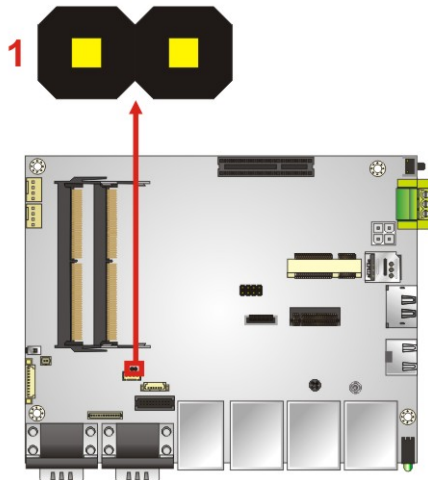

Figure 4-2: ME Override Jumper Location

To update the ME firmware, please follow the steps below.

- Step 1:** Before turning on the system power, short the ME Override jumper.
- Step 2:** Update the BIOS and ME firmware, and then turn off the system power.
- Step 3:** Remove the metal clip on the ME Override jumper or return to its default setting (open).
- Step 4:** Restart the system. The system will reboot to complete the ME firmware update.

Chapter

5

BIOS

DRPC-230-ULT5 Embedded System

5.1 Introduction

The BIOS is programmed onto the BIOS chip. The BIOS setup program allows changes to certain system settings. This chapter outlines the options that can be changed.



NOTE:

Some of the BIOS options may vary throughout the life cycle of the product and are subject to change without prior notice.

5.1.1 Starting Setup

The UEFI BIOS is activated when the computer is turned on. The setup program can be activated in one of two ways.

1. Press the **DEL** or **F2** key as soon as the system is turned on or
2. Press the **DEL** or **F2** key when the “**Press DEL or F2 to enter SETUP**” message appears on the screen.

If the message disappears before the **DEL** or **F2** key is pressed, restart the computer and try again.

5.1.2 Using Setup

Use the arrow keys to highlight items, press **ENTER** to select, use the PageUp and PageDown keys to change entries, press **F1** for help and press **ESC** to quit. Navigation keys are shown in **Table 5-1**.

Key	Function
Up arrow	Move to previous item
Down arrow	Move to next item
Left arrow	Move to the item on the left hand side
Right arrow	Move to the item on the right hand side
+	Increase the numeric value or make changes

Key	Function
-	Decrease the numeric value or make changes
Esc key	Main Menu – Quit and not save changes into CMOS Status Page Setup Menu and Option Page Setup Menu -- Exit current page and return to Main Menu
F1 key	General help, only for Status Page Setup Menu and Option Page Setup Menu
F2 key	Load previous values
F3 key	Load optimized defaults
F4 key	Save changes and exit BIOS

Table 5-1: BIOS Navigation Keys

5.1.3 Getting Help

When **F1** is pressed a small help window describing the appropriate keys to use and the possible selections for the highlighted item appears. To exit the Help Window press **Esc** or the **F1** key again.

5.1.4 Unable to Reboot after Configuration Changes

If the computer cannot boot after changes to the system configuration is made, CMOS defaults. Use the clear CMOS button described in **Chapter 3**.

5.1.5 BIOS Menu Bar

The **menu bar** on top of the BIOS screen has the following main items:

- Main – Changes the basic system configuration.
- Advanced – Changes the advanced system settings.
- Chipset – Changes the chipset settings.
- Security – Sets User and Supervisor Passwords.
- Boot – Changes the system boot configuration.
- Save & Exit – Selects exit options and loads default settings

DRPC-230-ULT5 Embedded System

The following sections completely describe the configuration options found in the menu items at the top of the BIOS screen and listed above.

5.2 Main

The **Main** BIOS menu (**BIOS Menu 1**) appears when the **BIOS Setup** program is entered.

The **Main** menu gives an overview of the basic system information.

```

Aptio Setup Utility - Copyright (C) 2019 American Megatrends, Inc.
Main  Advanced  Chipset  Security  Boot  Save & Exit

BIOS Information
BIOS Vendor                American Megatrends
Core Version                5.13
Compliance                 UEFI 2.7;PI1.6
Project Version             Z629AR11.BIN
Build Date and Time        12/19/2019 15:59:22

iWDD Vendor                iEi
iWDD Version                Z629ER11.bin

Processor Information
Name                       WhiskeyLake ULT
Type                       Intel(R) Core(TM)
                           i5-8365EU CPU@ 1.60GHz
Speed                      1800 MHz
ID                          0x806EC
Stepping                   V0
Number of Processors       4Core(s) / 8Thread(s)
Microcode Revision         CA
GT Info                     GT2 (0x3EA0)

IGFX VBIOS Version         1017
Memory RC Version          0.7.1.95
Total Memory                8192 MB
Memory Frequency           2400 MHz

-----

PCH Information
Name                       CNL PCH-LP
PCH SKU                     (U) Premium SKU
Stepping                    D0

ME FW Version              12.0.47.1524
ME Firmware SKU            Corporate SKU

Access Level                Administrator

System Date                 [Fri 01/01/2010]
System Time                 [00:18:35]

Set the Date. Use Tab to
switch between Data
elements.

-----

<->: Select Screen
^ v: Select Item
EnterSelect
+ -: Change Opt.
F1:  General Help
F2:  Previous Values
F3:  Optimized Defaults
F4:  Save & Exit
ESC: Exit

Version 2.20.1271. Copyright (C) 2019 American Megatrends, Inc.
  
```

BIOS Menu 1: Main

The System Overview field has two user configurable fields:

→ **System Date [xx/xx/xx]**

Use the **System Date** option to set the system date. Manually enter the day, month and year.

→ **System Time [xx:xx:xx]**

Use the **System Time** option to set the system time. Manually enter the hours, minutes and seconds.

5.3 Advanced

Use the **Advanced** menu (**BIOS Menu 2**) to configure the CPU and peripheral devices through the following sub-menus:



WARNING!

Setting the wrong values in the sections below may cause the system to malfunction. Make sure that the settings made are compatible with the hardware.

```

Aptio Setup Utility - Copyright (C) 2019 American Megatrends, Inc.
Main  Advanced  Chipset  Security  Boot  Save & Exit
-----
> CPU Configuration
> PCH-FW Configuration
> Trusted Computing
> ACPI Settings
> RTC Wake Settings
> iWDD H/W Monitor
> F81866 Super IO Configuration
> Serial Port Console Redirection
> USB Configuration
> CSM Configuration
> NVMe Configuration
> iEi Feature

System ACPI Parameters.
-----
<=>: Select Screen
↑↓: Select Item
Enter
F1  General Help
F2  Previous Values
F3  Optimized Defaults
F4  Save
ESC Exit

Version 2.20.1271. Copyright (C) 2019 American Megatrends, Inc.
    
```

BIOS Menu 2: Advanced

DRPC-230-ULT5 Embedded System

5.3.1 CPU Configuration

Use the **CPU Configuration** menu (**BIOS Menu 3**) to view detailed CPU specifications and configure the CPU.

```

Aptio Setup Utility - Copyright (C) 2019 American Megatrends, Inc.
  Advanced
CPU Configuration
Type                Intel(R) Core(TM)
                   i5-8365EU CPU@
                   1.60GHz
ID                  0x806EC
Speed               1800 MHz
L1 Data Cache      32 KB x 4
L1 Instruction Cache 32 KB x 4
L2 Cache           256 KB x 4
L3 Cache           6 MB
L4 Cache           N/A
VMX                 Supported
SMX/TXT             Supported

Intel (VMX) Virtualization [Disabled]
Technology
Active Processor Cores [All]
Hyper-Threading       [Enabled]
Intel(R) SpeedStep(tm) [Enabled]
C states               [Disabled]
Intel Trusted Execution Technology [Disabled]

When enabled, a VMM can
utilize the additional
hardware capabilities
provided by Vanderpool
Technology.

-----
<->: Select Screen
↑ ↓: Select Item
Enter
F1  General Help
F2  Previous Values
F3  Optimized
Defaults
F4  Save
ESC Exit

Version 2.20.1271. Copyright (C) 2019 American Megatrends, Inc.
  
```

BIOS Menu 3: CPU Configuration

→ Intel® (VMX) Virtualization Technology [Disabled]

Use the **Intel® (VMX) Virtualization Technology** option to enable or disable virtualization on the system. When combined with third party software, Intel® Virtualization technology allows several OSs to run on the same system at the same time.

- **Disabled** **DEFAULT** Disables Intel® Virtualization Technology.
- **Enabled** Enables Intel® Virtualization Technology.

→ Active Processor Cores [All]

Use the **Active Processor Cores** BIOS option to enable numbers of cores in the processor package.

- All** **DEFAULT** Enable all cores in the processor package.
- 1** Enable one core in the processor package.
- 2** Enable two cores in the processor package.
- 3** Enable three cores in the processor package.

→ Hyper-threading [Enabled]

Use the **Hyper-threading** BIOS option to enable or disable the Intel Hyper-Threading Technology.

- Disabled** Disables the Intel Hyper-Threading Technology.
- Enabled** **DEFAULT** Enables the Intel Hyper-Threading Technology.

→ Intel® SpeedStep™ [Enabled]

Use the **Intel® SpeedStep™** option to enable or disable the Intel® SpeedStep Technology.

- Disabled** Disables the Intel® SpeedStep Technology.
- Enabled** **DEFAULT** Enables the Intel® SpeedStep Technology.

→ C State [Disabled]

Use the **C State** option to enable or disable CPU C state.

- Disabled** **DEFAULT** Disables CPU C state.
- Enabled** Enables CPU C state.

DRPC-230-ULT5 Embedded System

5.3.2 PCH-FW Configuration

The **PCH-FW Configuration** menu (**BIOS Menu 4**) allows Intel® Active Management Technology (AMT) options to be configured.

```

Aptio Setup Utility - Copyright (C) 2019 American Megatrends, Inc.
  Advanced
AMT BIOS Features                [Enabled]
Unconfigure ME                   [Disabled]
> PTT Configuration

When disabled AMT BIOS
Features are no longer
supported and user is no
longer able to access MEBx
Setup.
Notes: This option does
not disable
Manageability Features
in FW.

-----
<=>:Select Screen
↑↓:Select Item
Enter
F1  General Help
F2  Previous Values
F3  Optimized Defaults
F4  Save
ESC Exit

Version 2.20.1271. Copyright (C) 2019 American Megatrends, Inc.
  
```

BIOS Menu 4: PCH-FW Configuration

➔ AMT BIOS Features [Enabled]

Use **AMT BIOS Features** option to enable or disable the Intel® AMT function.

- ➔ **Disabled** Intel® AMT is disabled
- ➔ **Enabled** **DEFAULT** Intel® AMT is enabled

➔ Unconfigure ME [Disabled]

Use the **Unconfigure ME** option to perform ME unconfigure without password operation.

- ➔ **Disabled** **DEFAULT** Not perform ME unconfigure
- ➔ **Enabled** To perform ME unconfigure

5.3.2.1 PTT Configuration

Use the **PTT Configuration** menu (**BIOS Menu 5**) to configure settings related to the Trusted Platform Module (TPM).

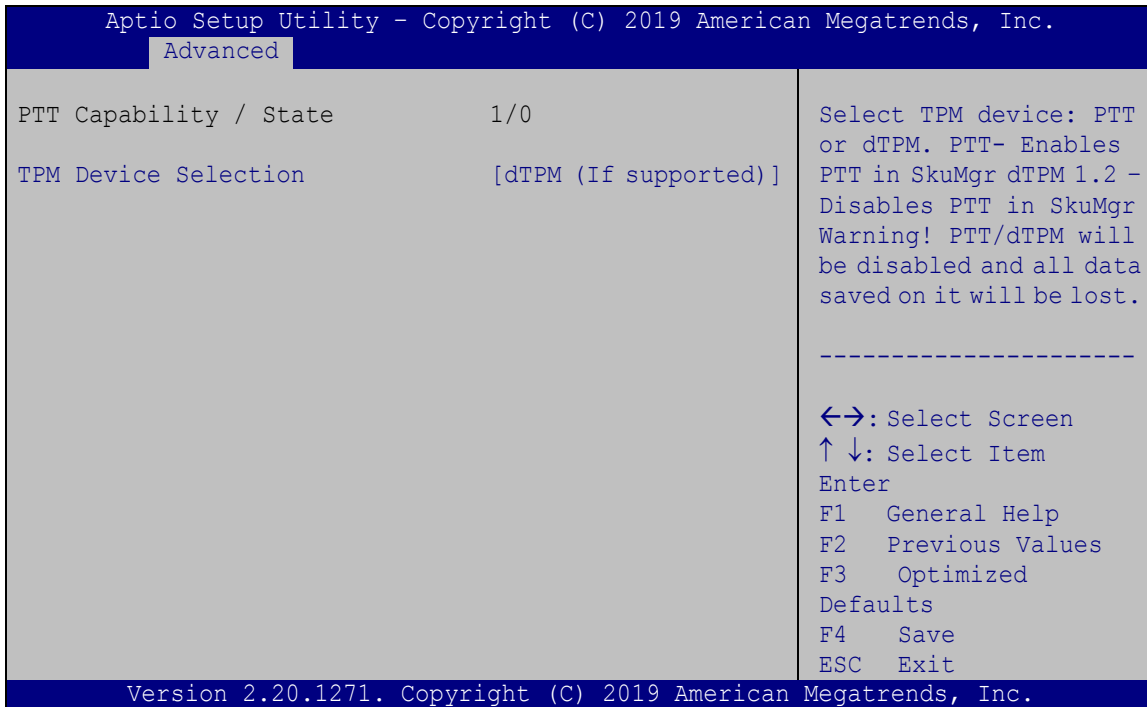

BIOS Menu 5: PTT Configuration

→ TPM Device Selection [dTPM (If supported)]

Use the **TPM Device Selection** option to configure support for the TPM.

- **dTPM** (If **DEFAULT** supported) Disable PTT in SkuMgr.
- **PTT** Enable PTT in SkuMgr

DRPC-230-ULT5 Embedded System

5.3.3 Trusted Computing

Use the **Trusted Computing** menu (**BIOS Menu 6**) to configure settings related to the Trusted Computing Group (TCG) Trusted Platform Module (TPM).

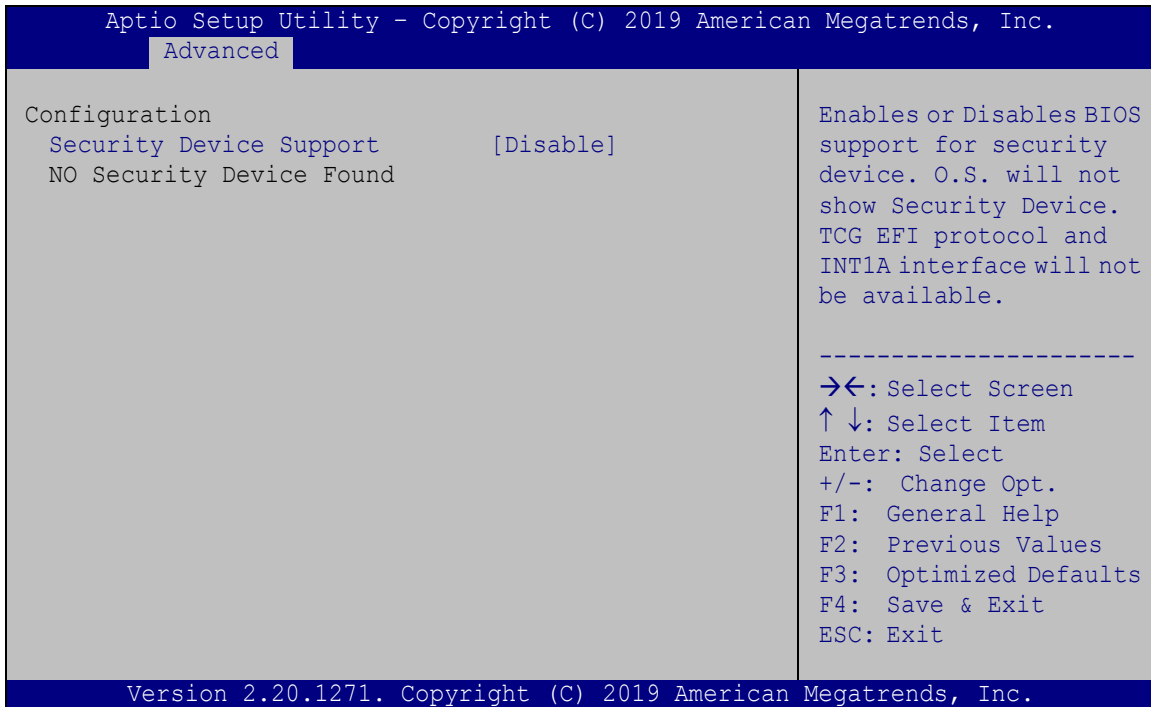

BIOS Menu 6: Trusted Computing

→ Security Device Support [Disable]

Use the **Security Device Support** option to configure support for the TPM.

- **Disable** **DEFAULT** TPM support is disabled.
- **Enable** TPM support is enabled.

5.3.4 ACPI Settings

The **ACPI Settings** menu (**BIOS Menu 7**) configures the Advanced Configuration and Power Interface (ACPI) options.

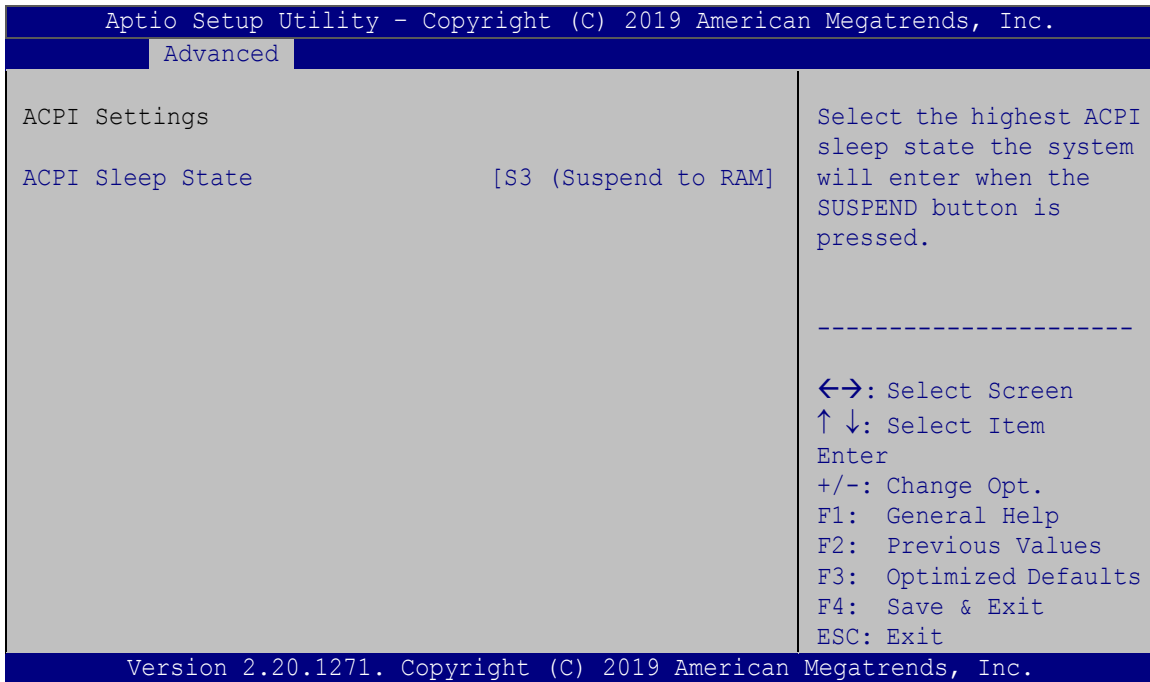

BIOS Menu 7: ACPI Settings

→ ACPI Sleep State [S3 (Suspend to RAM)]

Use the **ACPI Sleep State** option to specify the sleep state the system enters when it is not being used.

- **S3 (Suspend to DEFAULT RAM)** The caches are flushed and the CPU is powered off. Power to the RAM is maintained. The computer returns slower to a working state, but more power is saved.

DRPC-230-ULT5 Embedded System

5.3.5 RTC Wake Settings

The **RTC Wake Settings** menu (**BIOS Menu 8**) configures RTC wake event.

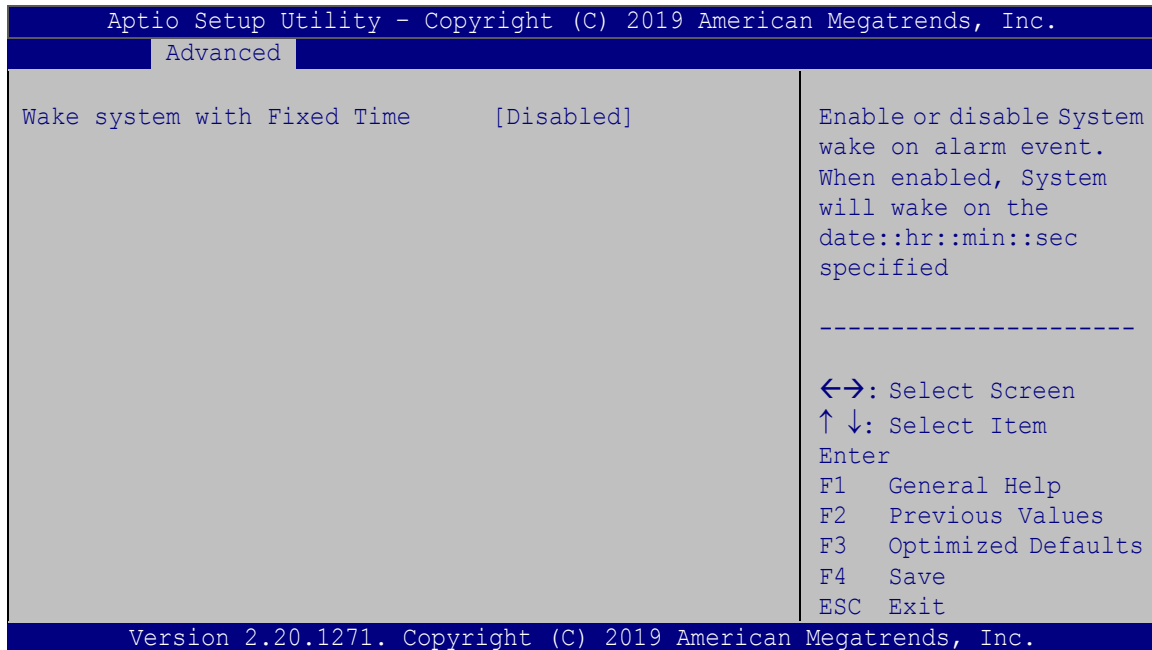

BIOS Menu 8: RTC Wake Settings

→ Wake system with Fixed Time [Disabled]

Use the **Wake system with Fixed Time** option to enable or disable the system wake on alarm event.

- **Disabled** **DEFAULT** The real time clock (RTC) cannot generate a wake event
- **Enabled** If selected, the **Wake up every day** option appears allowing you to enable to disable the system to wake every day at the specified time. Besides, the following options appear with values that can be selected:

Wake up date

Wake up hour

Wake up minute

Wake up second

After setting the alarm, the computer turns itself on from a suspend state when the alarm goes off.

5.3.6 iWDD H/W Monitor

The **iWDD H/W Monitor** menu (**BIOS Menu 9**) contains the fan configuration submenus and displays operating temperature, fan speeds and system voltages.

```

Aptio Setup Utility - Copyright (C) 2019 American Megatrends, Inc.
Advanced
PC Health Status
CPU temperature           :+31 °C
System temperature       :+30 °C
CPU_FAN1 Speed           :N/A
+VCCCORE                 :+0.771 V
+VDDQ                    :+1.219 V
+V1.05A                  :+1.049 V
+VCCSA                   :+0.797 V
+3.3V                    :+3.387 V
+3.3VSB                  :+3.410 V
> Smart Fan Mode Configuration
Smart Fan Mode Select
-----
<=>: Select Screen
↑↓: Select Item
Enter
+ - Change Opt.
F1  General Help
F2  Previous Values
F3  Optimized Defaults
F4  Save & Exit
ESC Exit
Version 2.20.1271. Copyright (C) 2019 American Megatrends, Inc.
    
```

BIOS Menu 9: iWDD H/W Monitor

→ PC Health Status

The following system parameters and values are shown. The system parameters that are monitored are:

- System Temperatures:
 - CPU Temperature
 - System temperature
- Fan Speed:
 - CPU Fan Speed
- Voltages
 - +VCCCORE

DRPC-230-ULT5 Embedded System

- +VDDQ
- +V1.05A
- +VCCSA
- +3.3V
- +3.3VSB

5.3.6.1 Smart Fan Mode Configuration

Use the **Smart Fan Mode Configuration** submenu (**BIOS Menu 10**) to configure fan temperature and speed settings.

```

Aptio Setup Utility - Copyright (C) 2019 American Megatrends, Inc.
-----
Advanced
-----
Smart Fan Mode Configuration
CPU_FAN1 Smart Fan Control          [Auto Mode]
Auto mode fan start temperature     40
Auto mode fan off temperature       30
Auto mode fan start PWM             30
Auto mode fan slope PWM             2

Smart Fan Mode Select
-----
<=>: Select Screen
↑ ↓: Select Item
Enter
+ - Change Opt.
F1 General Help
F2 Previous Values
F3 Optimized Defaults
F4 Save & Exit
ESC Exit

Version 2.20.1271. Copyright (C) 2019 American Megatrends, Inc.
  
```

BIOS Menu 10: Smart Fan Mode Configuration

→ CPU_FAN1 Smart Fan Control [Auto Mode]

Use the **CPU_FAN1 Smart Fan Control** BIOS option to configure the CPU Smart Fan.

→ Manual Mode

The fan spins at the speed set in the Manual Mode option

→ **Auto Mode** **DEFAULT** The fan adjusts its speed using these settings:

Auto mode fan start temperature

Auto mode fan off temperature

Auto mode fan start PWM

Auto mode fan slope PWM

→ **Auto mode fan start temperature [40]**



WARNING:

Setting this value too high may cause the fan to rotate at full speed only when the CPU is at a very high temperature and therefore cause the system to be damaged.

The **Auto mode fan start temperature** option can only be set if the **CPU_FAN1 Smart Fan Control** option is set to **Auto Mode**. If the system temperature is between **Start Temperature** and **Off Temperature**, the fan speed change to be **Start PWM**. To set a value, select the **Auto mode fan start temperature** option and enter a decimal number between 1 and 100.

→ **Auto mode fan off temperature [30]**



WARNING:

Setting this value too high may cause the fan to speed up only when the CPU is at a very high temperature and therefore cause the system to be damaged.

The **Auto mode fan off temperature** option can only be set if the **CPU_FAN1 Smart Fan control** option is set to **Auto Mode**. If the system temperature is lower than **Auto mode**

DRPC-230-ULT5 Embedded System

fan off temperature, the fan speed change to be lowest. To set a value, select the **Auto mode fan off temperature** option and enter a decimal number between 1 and 100.

→ Auto mode fan start PWM [30]

The **Auto mode fan start PWM** option can only be set if the **CPU_FAN1 Smart Fan control** option is set to **Auto Mode**. Use the **Auto mode fan start PWM** option to set the PWM start value. To set a value, select the **Auto mode fan start PWM** option and enter a decimal number between 1 and 100.

→ Auto mode fan slope PWM [2]

The **Auto mode fan slope PWM** option can only be set if the **CPU_FAN1 Smart Fan control** option is set to **Auto Mode**. Use the **Auto mode fan slope PWM** option to select the linear rate at which the PWM mode increases with respect to an increase in temperature. To set a value, select the **Auto mode fan slope PWM** option and enter a decimal number between 1 and 8.

5.3.7 F81866 Super IO Configuration

Use the **F81866 Super IO Configuration** menu (**BIOS Menu 11**) to set or change the configurations for the serial ports.

```

Aptio Setup Utility - Copyright (C) 2019 American Megatrends, Inc.
  Advanced
F81866 Super IO Configuration
Super IO Chip                      F81866
> Serial Port 1 Configuration
> Serial Port 2 Configuration
> Serial Port 3 Configuration
> Serial Port 4 Configuration
> Serial Port 5 Configuration
> Serial Port 6 Configuration
Set Parameters of Serial
Port 1 (COMA)
-----
<=>: Select Screen
↑ ↓: Select Item
Enter
F1  General Help
F2  Previous Values
F3  Optimized
Defaults
F4  Save
ESC Exit
Version 2.20.1271. Copyright (C) 2019 American Megatrends, Inc.

```

BIOS Menu 11: F81866 Super IO Configuration

5.3.7.1 Serial Port n Configuration

Use the **Serial Port n Configuration** menu (**BIOS Menu 12**) to configure the serial port n.

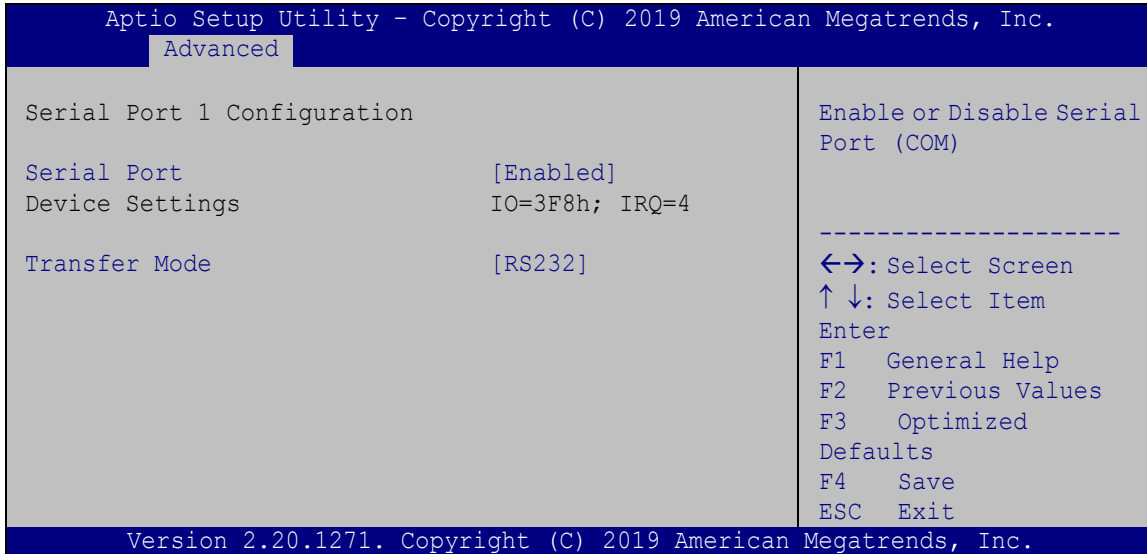

BIOS Menu 12: Serial Port n Configuration

→ Serial Port [Enabled]

Use the **Serial Port** option to enable or disable the serial port.

- **Disabled** Disable the serial port
- **Enabled** **DEFAULT** Enable the serial port

→ Transfer Mode [RS232]

Use the **Transfer Mode** option to configure the serial port.

- **RS422** Configure the serial port as RS-422 mode
- **RS232** **DEFAULT** Configure the serial port as RS-232 mode
- **RS485** Configure the serial port as RS-485 mode

DRPC-230-ULT5 Embedded System

5.3.8 Serial Port Console Redirection

The **Serial Port Console Redirection** menu (**BIOS Menu 13**) allows the console redirection options to be configured. Console redirection allows users to maintain a system remotely by re-directing keyboard input and text output through the serial port.

```

Aptio Setup Utility - Copyright (C) 2019 American Megatrends, Inc.
  Advanced
COM1
Console Redirection [Disabled] Console Redirection
> Console Redirection Settings Enable or Disable

COM2
Console Redirection [Disabled]
> Console Redirection Settings

COM3
Console Redirection [Disabled]
> Console Redirection Settings

COM4
Console Redirection [Disabled]
> Console Redirection Settings

COM5
Console Redirection [Disabled]
> Console Redirection Settings

COM6
Console Redirection [Disabled]
> Console Redirection Settings

iAMT SOL

COM7(Pci Bus0, Dev0, Func0) (Disabled)
Console Redirection Port Is Disabled

Legacy Console Redirection
> Legacy Console Redirection Settings

-----
<=>: Select Screen
↑ ↓: Select Item
Enter
F1 General Help
F2 Previous Values
F3 Optimized
Defaults
F4 Save
ESC Exit

Version 2.20.1271. Copyright (C) 2019 American Megatrends, Inc.
  
```

BIOS Menu 13: Serial Port Console Redirection

➔ **Console Redirection [Disabled]**

Use **Console Redirection** option to enable or disable the console redirection function.

- ➔ **Disabled** **DEFAULT** Disabled the console redirection function
- ➔ **Enabled** Enabled the console redirection function

5.3.8.1 Legacy Console Redirection Settings

The **Legacy Console Redirection Settings** menu (**BIOS Menu 14**) allows the legacy console redirection options to be configured.

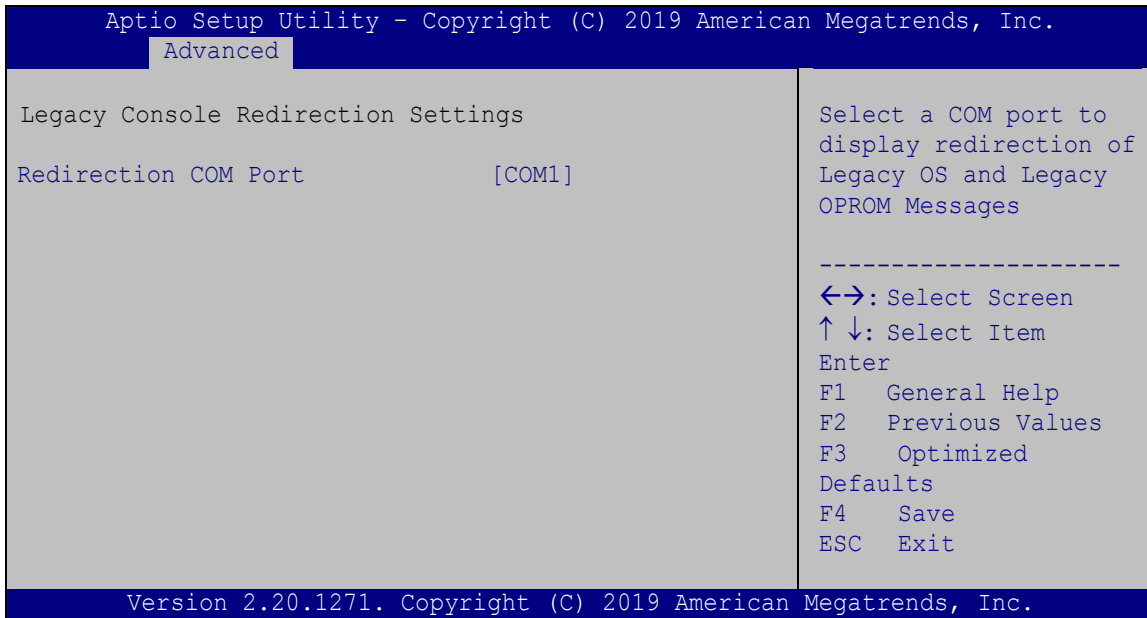

BIOS Menu 14: Legacy Console Redirection Settings

➔ **Legacy Serial Redirection Port [COM1]**

Use the **Legacy Serial Redirection Port** option to specify a COM port to display redirection of legacy OS and legacy OPRM messages. The options include:

- **COM1** **DEFAULT**
- **COM2**
- **COM3**
- **COM4**
- **COM5**

DRPC-230-ULT5 Embedded System

- COM6
- COM7 (Pci Bus0, Dev0, Func0) (Disabled)

5.3.8.2 Console Redirection Settings

The **Console Redirection Settings** menu (**BIOS Menu 15**) allows the console redirection options to be configured. The option is active when Console Redirection option is enabled.

```

Aptio Setup Utility - Copyright (C) 2019 American Megatrends, Inc.
  Advanced
COM1
Console Redirection Settings

Terminal Type                [ANSI]
Bits per second              [115200]
Data Bits                    [8]
Parity                       [None]
Stop Bits                    [1]

Emulation: ANSI:
Extended ASCII char set.
VT100: ASCII char set.
VT100+: Extends VT100 to
support color, function
keys, etc. VT-UTF8: Uses
UTF8 encoding to map
Unicode chars onto 1 or
more bytes.

-----
<=>: Select Screen
↑ ↓: Select Item
Enter
F1  General Help
F2  Previous Values
F3  Optimized
Defaults
F4  Save
ESC Exit

Version 2.20.1271. Copyright (C) 2019 American Megatrends, Inc.
  
```

BIOS Menu 15: Console Redirection Settings

➔ Terminal Type [ANSI]

Use the **Terminal Type** option to specify the remote terminal type.

- ➔ **VT100** The target terminal type is VT100
- ➔ **VT100+** The target terminal type is VT100+
- ➔ **VT-UTF8** The target terminal type is VT-UTF8
- ➔ **ANSI** **DEFAULT** The target terminal type is ANSI

→ Bits per second [115200]

Use the **Bits per second** option to specify the serial port transmission speed. The speed must match the other side. Long or noisy lines may require lower speeds.

- **9600** Sets the serial port transmission speed at 9600.
- **19200** Sets the serial port transmission speed at 19200.
- **57600** Sets the serial port transmission speed at 57600.
- **115200** **DEFAULT** Sets the serial port transmission speed at 115200.

→ Data Bits [8]

Use the **Data Bits** option to specify the number of data bits.

- **7** Sets the data bits at 7.
- **8** **DEFAULT** Sets the data bits at 8.

→ Parity [None]

Use the **Parity** option to specify the parity bit that can be sent with the data bits for detecting the transmission errors.

- **None** **DEFAULT** No parity bit is sent with the data bits.
- **Even** The parity bit is 0 if the number of ones in the data bits is even.
- **Odd** The parity bit is 0 if the number of ones in the data bits is odd.
- **Mark** The parity bit is always 1. This option does not provide error detection.
- **Space** The parity bit is always 0. This option does not provide error detection.

DRPC-230-ULT5 Embedded System

→ Stop Bits [1]

Use the **Stop Bits** option to specify the number of stop bits used to indicate the end of a serial data packet. Communication with slow devices may require more than 1 stop bit.

- 1 **DEFAULT** Sets the number of stop bits at 1.
- 2 Sets the number of stop bits at 2.

5.3.9 USB Configuration

Use the **USB Configuration** menu (**BIOS Menu 16**) to read USB configuration information and configure the USB settings.

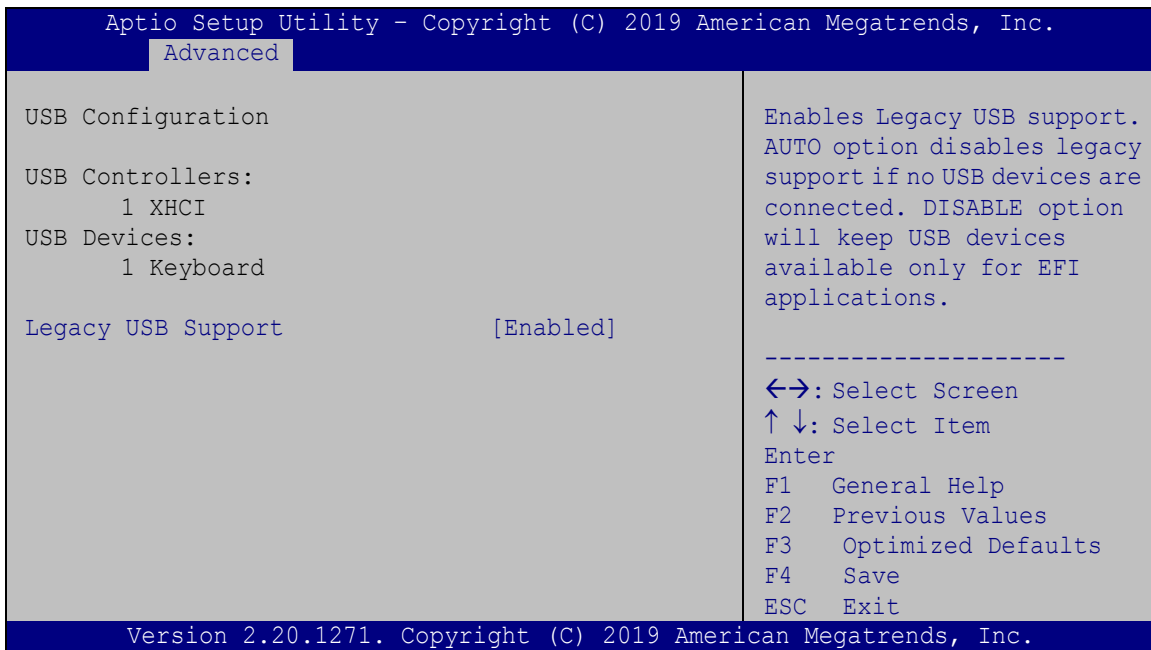

BIOS Menu 16: USB Configuration

→ USB Devices

The **USB Devices Enabled** field lists the USB devices that are enabled on the system

→ Legacy USB Support [Enabled]

Use the **Legacy USB Support** BIOS option to enable USB mouse and USB keyboard support. Normally if this option is not enabled, any attached USB mouse or USB keyboard does not become available until a USB compatible operating system is fully booted with all

USB drivers loaded. When this option is enabled, any attached USB mouse or USB keyboard can control the system even when there is no USB driver loaded onto the system.

- ➔ **Enabled** **DEFAULT** Legacy USB support enabled
- ➔ **Disabled** Legacy USB support disabled
- ➔ **Auto** Legacy USB support disabled if no USB devices are connected

5.3.10 CSM Configuration

Use the **CSM Configuration** menu (**BIOS Menu 17**) to configure Compatibility Support Module (CSM).

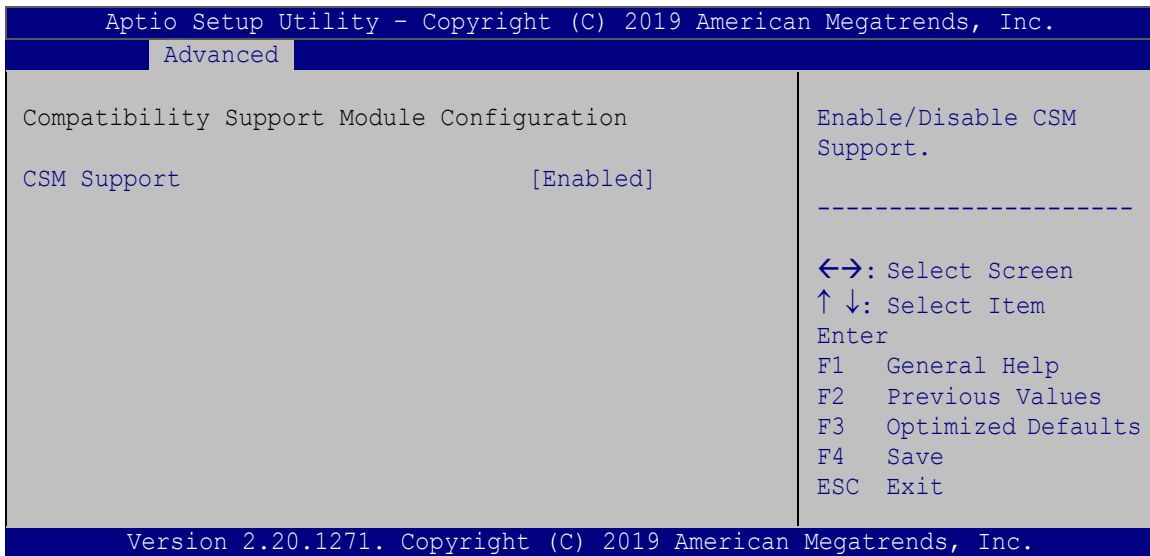

BIOS Menu 17: CSM Configuration

➔ **CSM Support [Enabled]**

Use the **CSM Support** BIOS option to enable or disable CSM support.

- ➔ **Disabled** CSM support disabled
- ➔ **Enabled** **DEFAULT** CSM support enabled

DRPC-230-ULT5 Embedded System

5.3.11 NVMe Configuration

Use the **NVMe Configuration (BIOS Menu 18)** menu to display the NVMe controller and device information.

```
Aptio Setup Utility - Copyright (C) 2018 American Megatrends, Inc.
Advanced
NVMe controller and Drive information
No NVMe Device Found
-----
-><: Select Screen
↑↓: Select Item
Enter: Select
+/-: Change Opt.
F1: General Help
F2: Previous Values
F3: Optimized Defaults
F4: Save & Exit
ESC: Exit
Version 2.20.1271. Copyright (C) 2018 American Megatrends, Inc.
```

BIOS Menu 18: NVMe Configuration

5.3.12 IEI Feature

Use the **IEI Feature** menu (**BIOS Menu 19**) to configure One Key Recovery function.

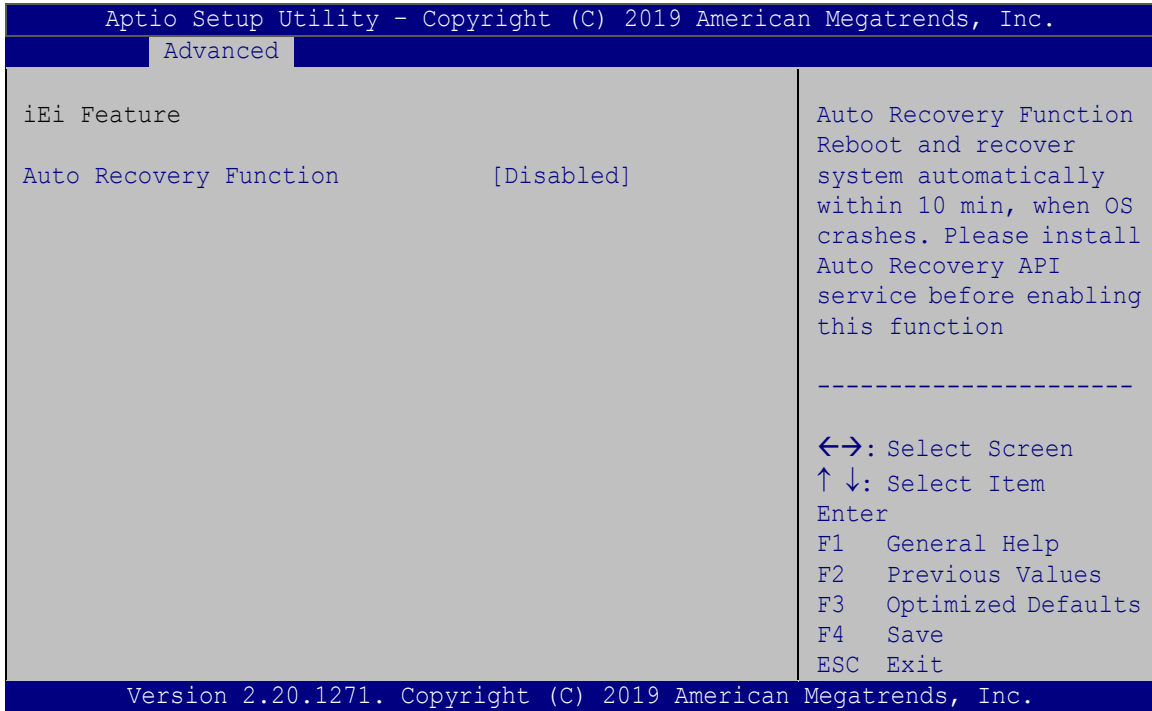

BIOS Menu 19: IEI Feature

➔ Auto Recovery Function [Disabled]

Use the **Auto Recovery Function** BIOS option to enable or disable the auto recovery function of the IEI One Key Recovery.

- ➔ **Disabled** **DEFAULT** Auto recovery function disabled
- ➔ **Enabled** Auto recovery function enabled

DRPC-230-ULT5 Embedded System

5.4 Chipset

Use the **Chipset** menu (**BIOS Menu 20**) to configure the system chipset.

```

Aptio Setup Utility - Copyright (C) 2019 American Megatrends, Inc.
Main   Advanced  Chipset   Boot   Security  Save & Exit

> System Agent (SA) Configuration
> PCH-IO Configuration

System Agent (SA)
Parameters

-----
<=>: Select Screen
↑↓: Select Item
EnterSelect
+ - Change Opt.
F1  General Help
F2  Previous Values
F3  Optimized Defaults
F4  Save & Exit
ESC Exit

Version 2.20.1271. Copyright (C) 2019 American Megatrends, Inc.
    
```

BIOS Menu 20: Chipset

5.4.1 System Agent (SA) Configuration

Use the **System Agent (SA) Configuration** menu (**BIOS Menu 21**) to configure the System Agent (SA) parameters.

```

Aptio Setup Utility - Copyright (C) 2019 American Megatrends, Inc.
Chipset

System Agent (SA) Configuration
VT-d                               Supported

> Memory Configuration
> Graphics Configuration

VT-d                               [Disabled]

Memory Configuration
Parameters

-----
<=>: Select Screen
↑↓: Select Item
EnterSelect
+ - Change Opt.
F1  General Help
F2  Previous Values
F3  Optimized Defaults
F4  Save & Exit
ESC Exit

Version 2.20.1271. Copyright (C) 2019 American Megatrends, Inc.
    
```

BIOS Menu 21: System Agent (SA) Configuration

→ VT-d [Disabled]

Use the **VT-d** option to enable or disable VT-d support.

- **Disabled** **DEFAULT** Disable VT-d support.
- **Enabled** Enable VT-d support.

5.4.1.1 Memory Configuration

Use the **Memory Configuration** submenu (**BIOS Menu 22**) to display the memory information.

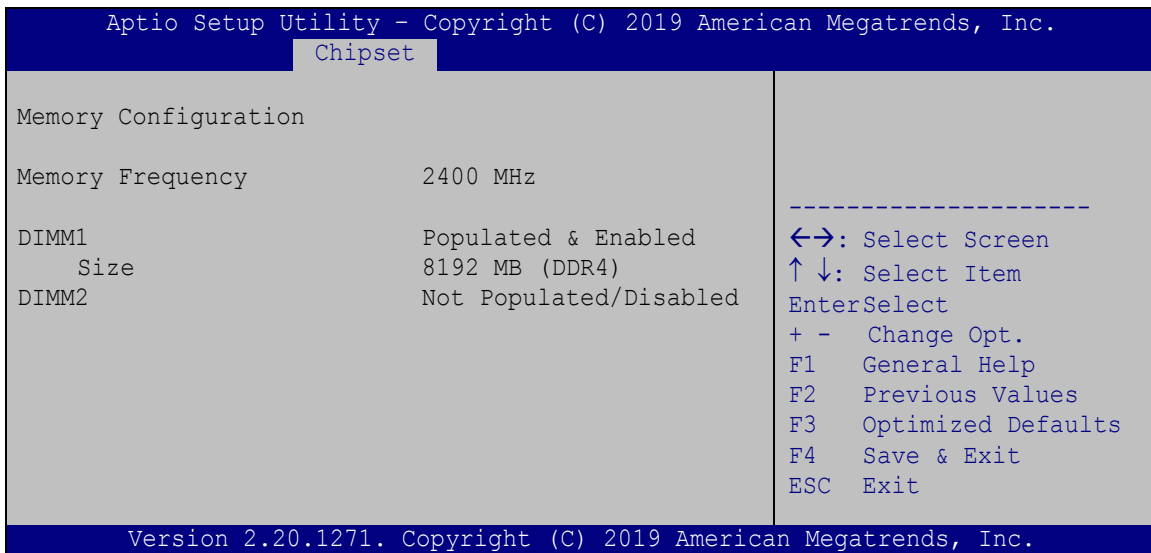

BIOS Menu 22: Memory Configuration

DRPC-230-ULT5 Embedded System

5.4.1.2 Graphics Configuration

Use the **Graphics Configuration** menu (**BIOS Menu 23**) to configure the graphics settings.

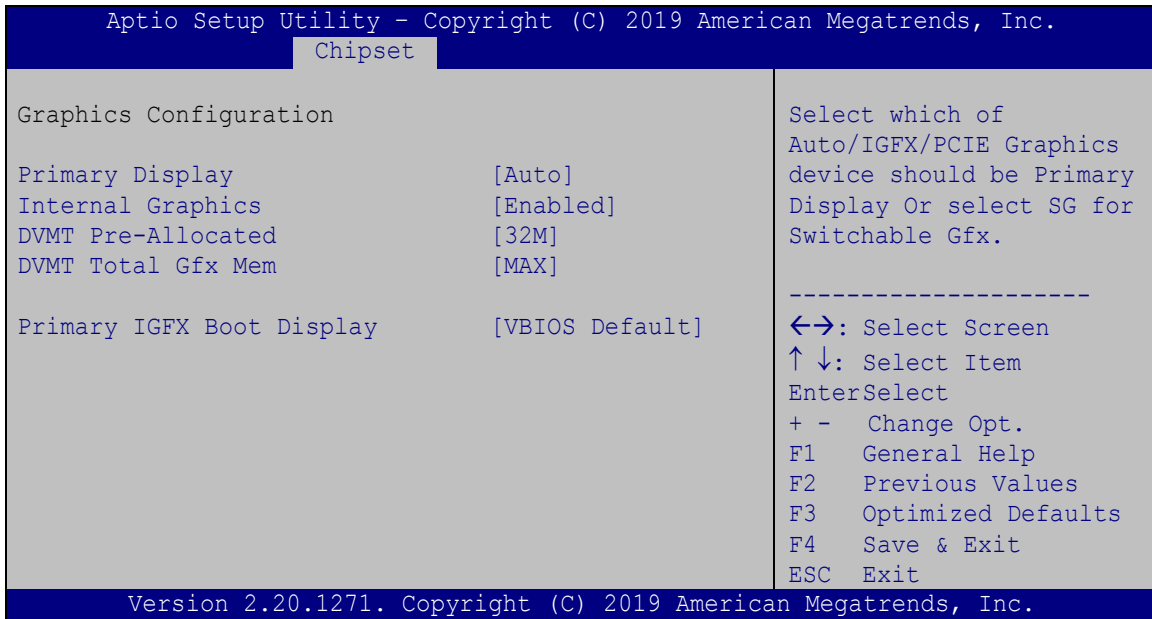

BIOS Menu 23: Graphics Configuration

→ Primary Display [Auto]

Use the **Primary Display** option to select the graphics controller used as the primary boot device. Configuration options are listed below:

- Auto **DEFAULT**
- IGFX
- PCI

→ Internal Graphics [Enabled]

Use the **Internal Graphics** option to enable or disable the internal graphics device.

- **Auto** The internal graphics device is automatically detected and enabled.
- **Disabled** Disable the internal graphics device.

→ **Enabled** **DEFAULT** Enable the internal graphics device. The following options/submenu appear with values that can be selected:

DVMT Pre-Allocated

DVMT Total Gfx Mem

LCD Control

→ **DVMT Pre-Allocated [32M]**

Use the **DVMT Pre-Allocated** option to set the amount of system memory allocated to the integrated graphics processor when the system boots. The system memory allocated can then only be used as graphics memory, and is no longer available to applications or the operating system. Configuration options are listed below:

- 32M **DEFAULT**
- 64M

→ **DVMT Total Gfx Mem [MAX]**

Use the **DVMT Total Gfx Mem** option to select DVMT 5.0 total graphic memory size used by the internal graphics device. The following options are available:

- 128M
- 256M
- MAX **DEFAULT**

→ **Primary IGFX Boot Display [VBIOS Default]**

Use the **Primary IGFX Boot Display** option to select the display device used by the system when it boots.

- VBIOS Default **DEFAULT**
- HDMI1
- DP1

DRPC-230-ULT5 Embedded System

5.4.2 PCH-IO Configuration

Use the **PCH-IO Configuration** menu (**BIOS Menu 24**) to configure the PCH-IO chipset.

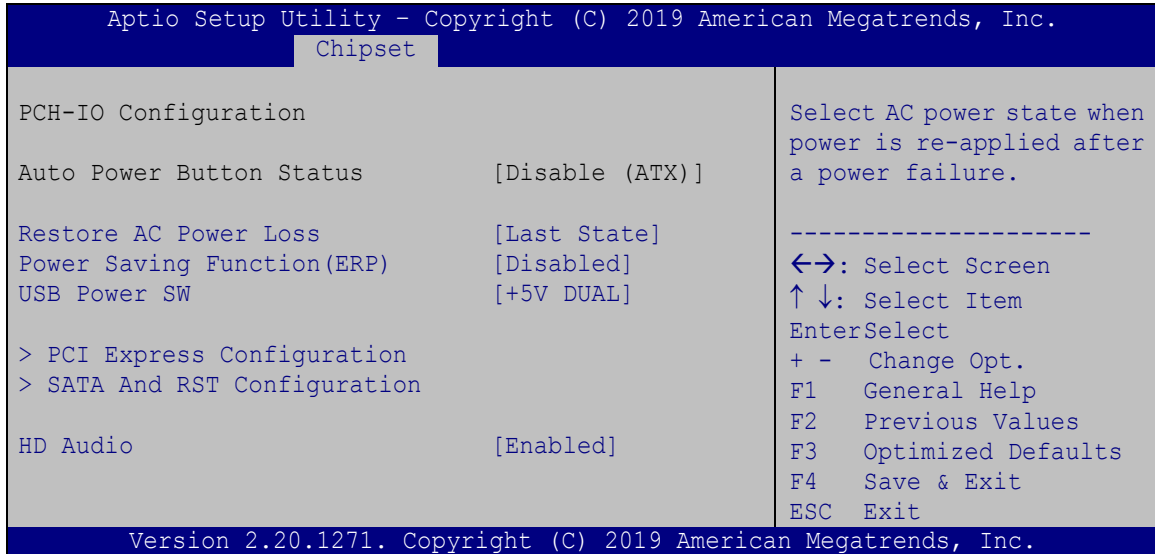

BIOS Menu 24: PCH-IO Configuration

→ Restore AC Power Loss [Last State]

Use the **Restore AC Power** BIOS option to specify what state the system returns to if there is a sudden loss of power to the system.

- **Power Off** The system remains turned off
- **Power On** The system turns on
- **Last State DEFAULT** The system returns to its previous state. If it was on, it turns itself on. If it was off, it remains off.

→ Power Saving Function(ERP) [Disabled]

Use the **Power Saving Function(ERP)** BIOS option to enable or disable the power saving function.

- Disabled DEFAULT** Power saving function is disabled.
- Enabled** Power saving function is enabled. It will reduce power consumption when the system is off.

→ USB Power SW [+5V DUAL]

Use the **USB Power SW** BIOS option to configure whether to provide power to the external USB 3.2 Gen 2 connectors when the system is in S3/S4 sleep state. This option is valid only when the above **Power Saving Function (ERP)** BIOS option is disabled.

- +5V DEFAULT** Power is provided to the USB connectors when the system is in S3/S4 sleep state
- +5V DUAL** Power is not provided to the USB connectors when the system is in S3/S4 sleep state

→ HD Audio [Enabled]

Use the **HD Audio** BIOS option to enable or disable the High Definition Audio controller.

- Disabled** The High Definition Audio controller is disabled.
- Enabled DEFAULT** The High Definition Audio controller is enabled.

DRPC-230-ULT5 Embedded System

5.4.2.1 PCI Express Configuration

Use the **PCI Express Configuration** submenu (**BIOS Menu 25**) to configure the PCI Express slots.

```

Aptio Setup Utility - Copyright (C) 2019 American Megatrends, Inc.
  Chipset
-----
PCI Express Configuration
> M2_A1
> MINI_PCIE1
> PCIEX4_1

PCI Express Root Port Settings.

-----
<=>: Select Screen
↑ ↓: Select Item
Enter
+ - Change Opt.
F1 General Help
F2 Previous Values
F3 Optimized Defaults
F4 Save & Exit
ESC Exit

Version 2.20.1271. Copyright (C) 2019 American Megatrends, Inc.
  
```

BIOS Menu 25: PCI Express Configuration

5.4.2.1.1 M2_A1 / MINI_PCIE1 / PCIEX4_1 Configuration

```

Aptio Setup Utility - Copyright (C) 2019 American Megatrends, Inc.
  Advanced
-----
M.2_A1 [Enabled]
PCIe Speed [Auto]
Detect Non-Compliance Device [Disabled]

Select PCI Express port speed.

-----
-><=: Select Screen
↑ ↓: Select Item
Enter: Select
+/-: Change Opt.
F1: General Help
F2: Previous Values
F3: Optimized Defaults
F4: Save & Exit
ESC: Exit

Version 2.20.1271. Copyright (C) 2019 American Megatrends, Inc.
  
```

BIOS Menu 26: M2_A1 / MINI_PCIE1 / PCIEX4_1 Configuration

→ M2_A1 / MINI_PCIE1 / PCIEX4_1 [Enabled]

Use the **M2_A1 / MINI_PCIE1 / PCIEX4_1** option to enable or disable the M.2, PCIe Mini or PCIe x4 expansion slots.

→ **Disabled** Disables the expansion slot.

→ **Enabled** **DEFAULT** Enables the expansion slot.

→ PCIe Speed [Auto]

Use this option to select the support type of the PCI Express slots. The following options are available:

- Auto **Default**
- Gen1
- Gen2
- Gen3

→ Detect Non-Compliance Device [Disabled]

Use the **Detect Non-Compliance Device** option to enable or disable detecting if a non-compliance PCI Express device is connected to the PCI Express slot.

→ **Disabled** **DEFAULT** Disables to detect if a non-compliance PCI Express device is connected to the PCI Express slot.

→ **Enabled** Enables to detect if a non-compliance PCI Express device is connected to the PCI Express slot.

DRPC-230-ULT5 Embedded System

5.4.2.2 SATA And RST Configuration

Use the **SATA And RST Configuration** menu (**BIOS Menu 27**) to change and/or set the configuration of the SATA devices installed in the system.

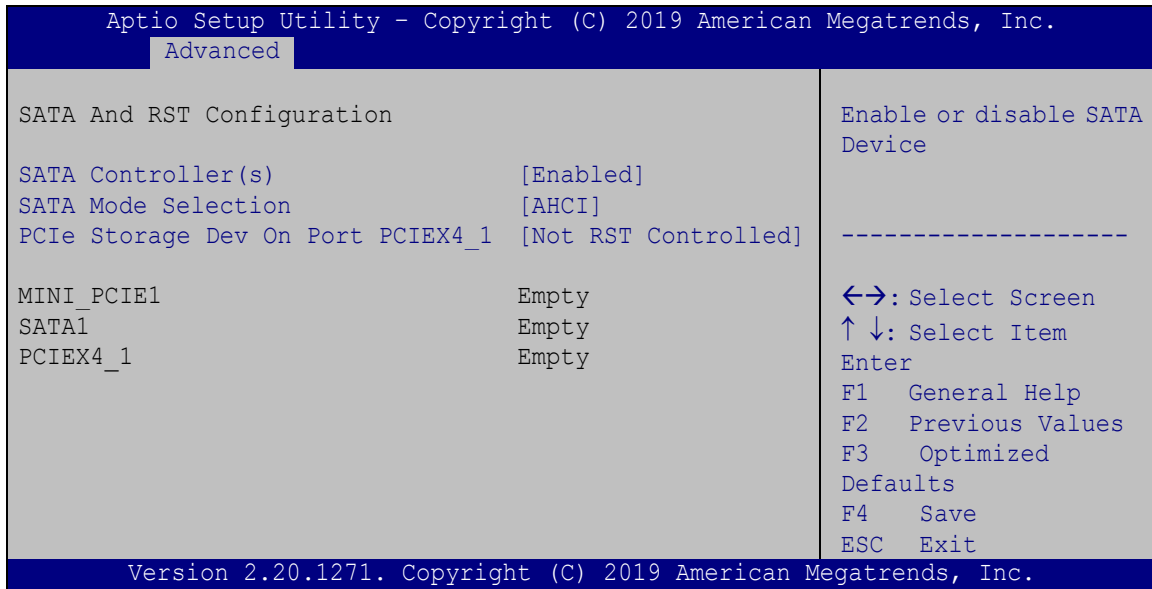

BIOS Menu 27: SATA and RST Configuration

→ SATA Controller(s) [Enabled]

Use the **SATA Controller(s)** option to enable or disable the SATA device.

- **Enabled** **DEFAULT** Enables the SATA device.
- **Disabled** Disables the SATA device.

→ **SATA Mode Selection [AHCI]**

Use the **SATA Mode Selection** option to configure how the SATA controller(s) operate.

- **AHCI** **DEFAULT** Configures SATA devices as AHCI device.
- **Intel RST
Premium
with Intel
Optane
System
Acceleration** Configures SATA devices as RAID device.

→ **PCIe Storage Dev On Port PCIEX4_1 [Not RST Controlled]**

Use the **PCIe Storage Dev On Port PCIEX4_1** option to enable or disable RST PCIe storage remapping.

- **RST
Controlled** Enables RST PCIe storage remapping. It is only supported by UEFI, so the **CSM Support** option must be disabled.
- **Not RST
Controlled** **DEFAULT** Disables RST PCIe storage remapping.

DRPC-230-ULT5 Embedded System

5.5 Security

Use the **Security** menu (**BIOS Menu 28**) to set system and user passwords.

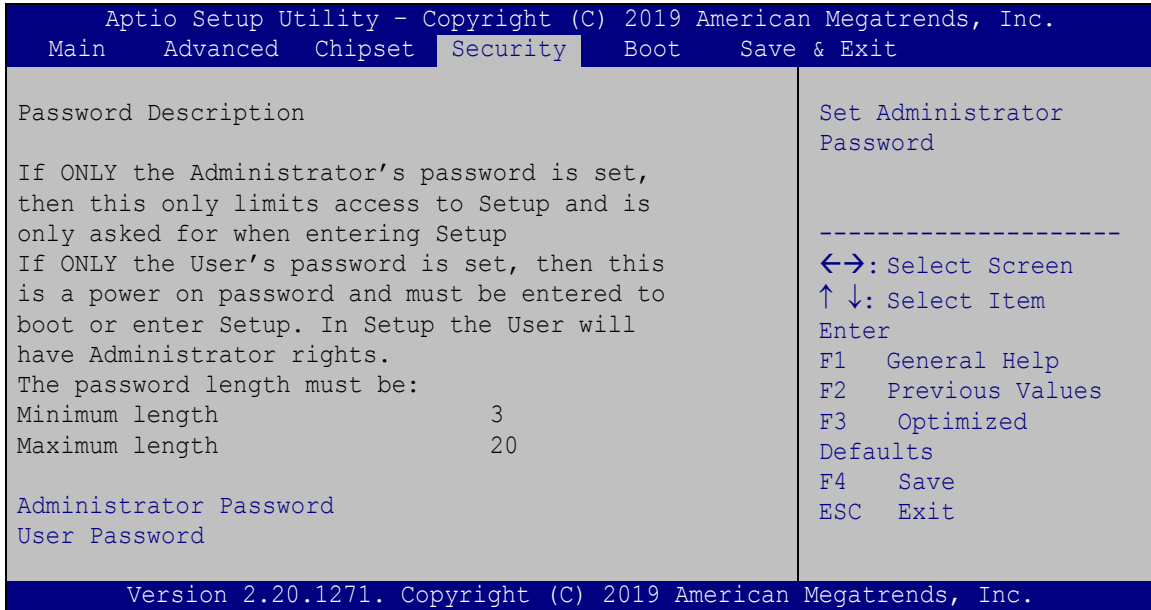

BIOS Menu 28: Security

➔ Administrator Password

Use the **Administrator Password** to set or change a administrator password.

➔ User Password

Use the **User Password** to set or change a user password.

5.6 Boot

Use the **Boot** menu (**BIOS Menu 29**) to configure system boot options.

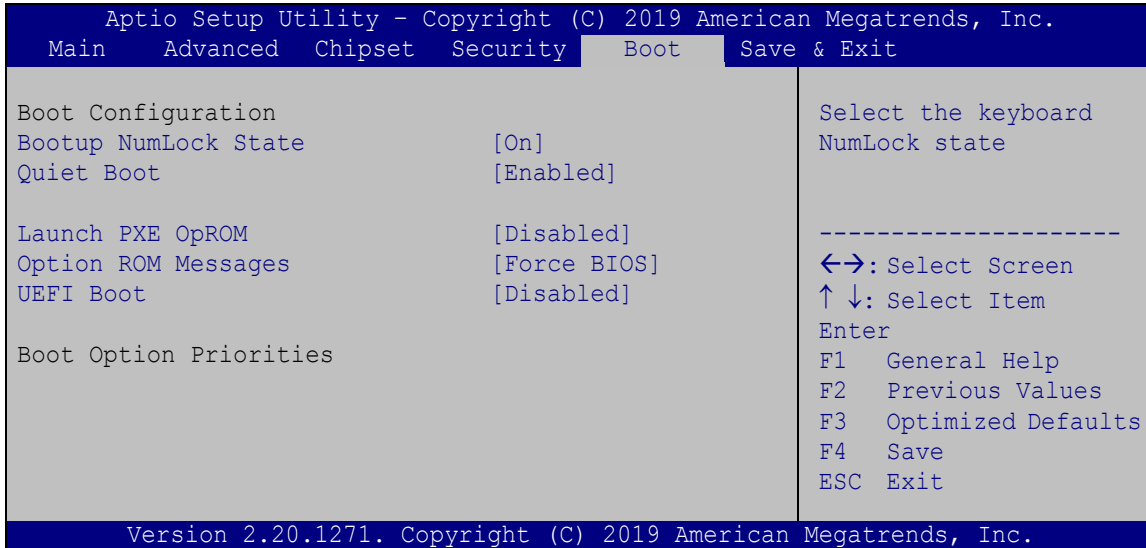

BIOS Menu 29: Boot

→ Bootup NumLock State [On]

Use the **Bootup NumLock State** BIOS option to specify if the number lock setting must be modified during boot up.

- **On** **DEFAULT** Allows the Number Lock on the keyboard to be enabled automatically when the computer system boots up. This allows the immediate use of the 10-key numeric keypad located on the right side of the keyboard. To confirm this, the Number Lock LED light on the keyboard is lit.

- **Off** Does not enable the keyboard Number Lock automatically. To use the 10-keys on the keyboard, press the Number Lock key located on the upper left-hand corner of the 10-key pad. The Number Lock LED on the keyboard lights up when the Number Lock is engaged.

DRPC-230-ULT5 Embedded System

→ Quiet Boot [Enabled]

Use the **Quiet Boot** BIOS option to select the screen display when the system boots.

- **Disabled** Normal POST messages displayed
- **Enabled** **DEFAULT** OEM Logo displayed instead of POST messages

→ Launch PXE OpROM [Disabled]

Use the **Launch PXE OpROM** option to enable or disable boot option for legacy network devices.

- **Disabled** **DEFAULT** Ignore all PXE Option ROMs
- **Enabled** Load PXE Option ROMs.

→ Option ROM Messages [Force BIOS]

Use the **Option ROM Messages** option to set the Option ROM display mode.

- **Force BIOS** **DEFAULT** Sets display mode to force BIOS.
- **Keep Current** Sets display mode to current.

→ UEFI Boot [Disabled]

Use the **UEFI Boot** option to enable or disable to boot from the UEFI devices.

- **Disabled** **DEFAULT** Boot from UEFI devices is disabled.
- **Enabled** Boot from UEFI devices is enabled.

→ Boot Option Priority

Use the **Boot Option Priority** function to set the system boot sequence from the available devices. The drive sequence also depends on the boot sequence in the individual device section.

5.7 Save & Exit

Use the **Save & Exit** menu (**BIOS Menu 30**) to load default BIOS values, optimal failsafe values and to save configuration changes.

```
Aptio Setup Utility - Copyright (C) 2019 American Megatrends, Inc.
Main  Advanced  Chipset  Security  Boot  Save & Exit

Save Changes and Reset
Discard Changes and Reset

Restore Defaults
Save as User Defaults
Restore User Defaults

Reset the system after
saving the changes.

-----
<->: Select Screen
↑ ↓: Select Item
Enter>Select
F1   General Help
F2   Previous Values
F3   Optimized
Defaults
F4   Save
ESC  Exit

Version 2.20.1271. Copyright (C) 2019 American Megatrends, Inc.
```

BIOS Menu 30: Save & Exit

→ Save Changes and Reset

Use the **Save Changes and Reset** option to save the changes made to the BIOS options and to exit the BIOS configuration setup program.

→ Discard Changes and Reset

Use the **Discard Changes and Reset** option to exit the system without saving the changes made to the BIOS configuration setup program.

→ Restore Defaults

Use the **Restore Defaults** option to load the optimal default values for each of the parameters on the Setup menus. **F3 key can be used for this operation.**

DRPC-230-ULT5 Embedded System

→ Save as User Defaults

Use the **Save as User Defaults** option to save the changes done so far as user defaults.

→ Restore User Defaults

Use the **Restore User Defaults** option to restore the user defaults to all the setup options.

Chapter

6

Interface Connectors

DRPC-230-ULT5 Embedded System

6.1 Peripheral Interface Connectors

The DRPC-230-ULT5 embedded system motherboard comes with a number of peripheral interface connectors and configuration jumpers. The connector locations are shown in **Table 6-1**. The Pin 1 locations of the on-board connectors are also indicated in the diagrams. The connector pinouts for these connectors are listed in the following sections.

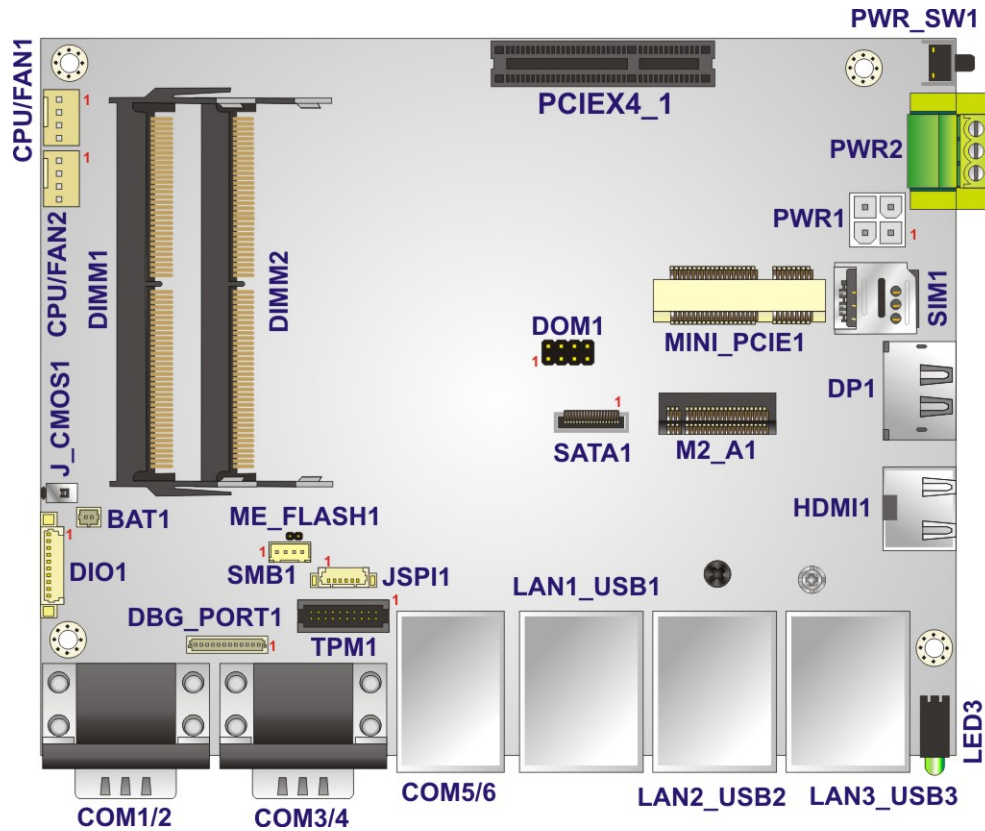

Figure 6-1: Main Board Layout Diagram

6.2 Internal Peripheral Connectors

Internal peripheral connectors on the motherboard and are only accessible when the motherboard is outside of the chassis. The table below shows a list of the connectors on the motherboard. Pinouts of these connectors can be found in the following sections.

Connector	Type	Label
Battery connector	2-pin wafer	BAT1
Debug port	12-pin wafer	DBG_PORT1
Digital I/O connector	10-pin wafer	DIO1
Fan connectors	4-pin wafer	CPU/FAN1, CPU/FAN2
Internal power connector	4-pin Molex	PWR1
Memory slots	SO-DIMM connector	DIMM1, DIMM2
M.2 A-key slot	M.2 A-key	M2_A1
PCIe Mini slot (full-size/half-size)	Full-size PCIe Mini slot	MINI_PCIE1
SATA connector	SATA connector	SATA1
PCIe x4 slot	PCIe x4 slot	PCIEX4_1
SIM card slot	SIM slot	SIM1
SMBus connector	4-pin wafer	SMB1
SPI flash connector	6-pin wafer	JSPI1
TPM connector	20-pin header	TPM1
USB DOM connector	8-pin header	DOM1

Table 6-1: Peripheral Interface Connectors

6.2.1 Battery Connector (BAT1)

PIN NO.	DESCRIPTION
1	+3V
2	GND

Table 6-2: Battery Connector (BAT1) Pinouts

DRPC-230-ULT5 Embedded System

6.2.2 Digital I/O Connector (DIO1)

PIN NO.	DESCRIPTION
1	GND
2	+5V
3	Output 3
4	Output 2
5	Output 1
6	Output 0
7	Input 3
8	Input 2
9	Input 1
10	Input 0

Table 6-3: Digital I/O Connector (DIO1) Pinouts

6.2.3 Fan Connectors (CPU/FAN1, CPU/FAN2)

PIN NO.	DESCRIPTION
1	GND
2	+V12S
3	Rotation Signal
4	PWM Control Signal

Table 6-4: Fan Connector (CPU/FAN1, CPU/FAN2) Pinouts

6.2.4 Internal Power Connector (PWR1)

PIN NO.	DESCRIPTION	PIN NO.	DESCRIPTION
1	GND	3	+12~24V
2	GND	4	+12~24V

Table 6-5: Internal Power Connector (PWR1) Pinouts

6.2.5 SATA Connector (SATA1)

PIN NO.	DESCRIPTION	PIN NO.	DESCRIPTION
1	GND	11	+V5S
2	GND	12	N/A
3	GND	13	N/A
4	GND	14	GND
5	GND	15	SATA_RX+
6	N/A	16	SATA_RX-
7	+V5S	17	GND
8	+V5S	18	SATA_TX-
9	+V5S	19	SATA_TX+
10	+V5S	20	GND

Table 6-6: SATA 6Gb/s Connector (SATA1) Pinouts

6.2.6 SMBus Connector (SMB1)

PIN NO.	DESCRIPTION
1	GND
2	SMBus (I ² C) Data
3	SMBus (I ² C) CLK
4	+5V

Table 6-7: SMBus Connector (SMB1) Pinouts

6.2.7 SPI Flash Connector (JSPI1)

PIN NO.	DESCRIPTION
1	+3.3V
2	SPI_CS
3	SPI_SO
4	SPI_CLK
5	SPI_SI
6	GND

Table 6-8: SPI Flash Connector (JSPI1) Pinouts

DRPC-230-ULT5 Embedded System

6.2.8 TPM Connector (TPM1)

PIN NO.	DESCRIPTION	PIN NO.	DESCRIPTION
1	KEY	2	SPI_TPM_CS0#
3	PM_RSTRSM#	4	NC
5	GND	6	GND
7	SPI_TPM_CLK	8	NC
9	Pull High	10	SPI_TPM_SO
11	SPI_TPM_HOLD#	12	SPI_TPM_SI
13	SPI_TPM_CS2#	14	GND
15	SPI_TPM_WP	16	NC
17	SPI_TPM_INT#	18	+3.3V+TPM
19	PCIE_RST#	20	NC

Table 6-9: TPM Connector (TPM1) Pinouts

6.2.9 USB DOM Connector (DOM1)

PIN NO.	DESCRIPTION	PIN NO.	DESCRIPTION
1	USB_VCC	2	NC
3	DATA-	4	NC
5	DATA+	6	NC
7	GND	8	NC

Table 6-10: USB DOM Connector (DOM1) Pinouts

Appendix

A

Regulatory Compliance

DECLARATION OF CONFORMITY

This equipment is in conformity with the following EU directives:

- EMC Directive 2014/30/EU
- Low-Voltage Directive 2014/35/EU
- RoHS II Directive 2015/863/EU

If the user modifies and/or install other devices in the equipment, the CE conformity declaration may no longer apply.

If this equipment has telecommunications functionality, it also complies with the requirements of the R&TTE Directive 1999/5/EC.

English

IEI Integration Corp declares that this equipment is in compliance with the essential requirements and other relevant provisions of Directive 1999/5/EC.

Български [Bulgarian]

IEI Integration Corp. декларира, че този оборудване е в съответствие със съществените изисквания и другите приложими правила на Директива 1999/5/EC.

Česky [Czech]

IEI Integration Corp tímto prohlašuje, že tento zařizení je ve shodě se základními požadavky a dalšími příslušnými ustanoveními směrnice 1999/5/ES.

Dansk [Danish]

IEI Integration Corp erklærer herved, at følgende udstyr overholder de væsentlige krav og øvrige relevante krav i direktiv 1999/5/EF.

Deutsch [German]

IEI Integration Corp, erklärt dieses Gerät entspricht den grundlegenden Anforderungen und den weiteren entsprechenden Vorgaben der Richtlinie 1999/5/EU.

Eesti [Estonian]

IEI Integration Corp deklareerib seadme seadme vastavust direktiivi 1999/5/EÜ põhinõuetele ja nimetatud direktiivist tulenevatele teistele asjakohastele sätetele.

Español [Spanish]

IEI Integration Corp declara que el equipo cumple con los requisitos esenciales y cualesquiera otras disposiciones aplicables o exigibles de la Directiva 1999/5/CE.

Ελληνική [Greek]

IEI Integration Corp ΔΗΛΩΝΕΙ ΟΤΙ ΕΞΟΠΛΙΣΜΟΣ ΣΥΜΜΟΡΦΩΝΕΤΑΙ ΠΡΟΣ ΤΙΣ ΟΥΣΙΩΔΕΙΣ ΑΠΑΙΤΗΣΕΙΣ ΚΑΙ ΤΙΣ ΛΟΙΠΕΣ ΣΧΕΤΙΚΕΣ ΔΙΑΤΑΞΕΙΣ ΤΗΣ ΟΔΗΓΙΑΣ 1999/5/EK.

Français [French]

IEI Integration Corp déclare que l'appareil est conforme aux exigences essentielles et aux autres dispositions pertinentes de la directive 1999/5/CE.

Italiano [Italian]

IEI Integration Corp dichiara che questo apparecchio è conforme ai requisiti essenziali ed alle altre disposizioni pertinenti stabilite dalla direttiva 1999/5/CE.

Latviski [Latvian]

IEI Integration Corp deklarē, ka iekārta atbilst būtiskajām prasībām un citiem ar to saistītajiem noteikumiem Direktīvas 1999/5/EK.

Lietuvių [Lithuanian]

IEI Integration Corp deklaruoja, kad šis įranga atitinka esminius reikalavimus ir kitas 1999/5/EB Direktyvos nuostatas.

Nederlands [Dutch]

IEI Integration Corp dat het toestel toestel in overeenstemming is met de essentiële eisen en de andere relevante bepalingen van richtlijn 1999/5/EG.

Malti [Maltese]

IEI Integration Corp jiddikjara li dan prodott jikkonforma mal-ħtiġijiet essenzjali u ma provvedimenti oħrajn relevanti li hemm fid-Dirrettiva 1999/5/EC.

Magyar [Hungarian]

IEI Integration Corp nyilatkozom, hogy a berendezés megfelel a vonatkozó alapvető követelményeknek és az 1999/5/EC irányelv egyéb előírásainak.

Polski [Polish]

IEI Integration Corp oświadcza, że wyrobu jest zgodny z zasadniczymi wymogami oraz pozostałymi stosownymi postanowieniami Dyrektywy 1999/5/EC.

Português [Portuguese]

IEI Integration Corp declara que este equipamento está conforme com os requisitos essenciais e outras disposições da Directiva 1999/5/CE.

DRPC-230-ULT5 Embedded System

Româna [Romanian]

IEI Integration Corp declară că acest echipament este în conformitate cu cerințele esențiale și cu celelalte prevederi relevante ale Directivei 1999/5/CE.

Slovensko [Slovenian]

IEI Integration Corp izjavlja, da je ta opreme v skladu z bistvenimi zahtevami in ostalimi relevantnimi določili direktive 1999/5/ES.

Slovensky [Slovak]

IEI Integration Corp týmto vyhlasuje, že zariadenia spĺňa základné požiadavky a všetky príslušné ustanovenia Smernice 1999/5/ES.

Suomi [Finnish]

IEI Integration Corp vakuuttaa täten että IiEi-tteet on direktiivin 1999/5/EY oleellisten vaatimusten ja sitä koskevien direktiivin muiden ehtojen mukainen.

Svenska [Swedish]

IEI Integration Corp förklarar att denna utrustningstyp står i överensstämmelse med de väsentliga egenskapskrav och övriga relevanta bestämmelser som framgår av direktiv 1999/5/EG.

FCC WARNING

This equipment complies with Part 15 of the FCC Rules. Operation is subject to the following two conditions:

- This device may not cause harmful interference, and
- This device must accept any interference received, including interference that may cause undesired operation.

This equipment has been tested and found to comply with the limits for a Class A digital device, pursuant to part 15 of the FCC Rules. These limits are designed to provide reasonable protection against harmful interference when the equipment is operated in a commercial environment. This equipment generates, uses, and can radiate radio frequency energy and, if not installed and used in accordance with the instruction manual, may cause harmful interference to radio communications. Operation of this equipment in a residential area is likely to cause harmful interference in which case the user will be required to correct the interference at his own expense.

ROHS STATEMENT

The label on the product indicates this product conforms to European (EU) Restriction of Hazardous Substances (RoHS) that set maximum concentration limits on hazardous materials used in electrical and electronic equipment.

CHINA ROHS

The label on the product indicates the estimated “Environmentally Friendly Use Period” (EFUP). This is an estimate of the number of years that these substances would “not leak out or undergo abrupt change.” This product may contain replaceable sub-assemblies/components which have a shorter EFUP such as batteries and lamps. These components will be separately marked.

Appendix

B

Safety Precautions

B.1 Safety Precautions



WARNING:

The precautions outlined in this appendix should be strictly followed. Failure to follow these precautions may result in permanent damage to the DRPC-230-ULT5.

Please follow the safety precautions outlined in the sections that follow:

B.1.1 General Safety Precautions

Please ensure the following safety precautions are adhered to at all times.

- ***Make sure the power is turned off and the power cord is disconnected*** when moving, installing or modifying the system.
- ***Do not apply voltage levels that exceed the specified voltage range.*** Doing so may cause fire and/or an electrical shock.
- ***Electric shocks can occur*** if opened while still powered on.
- ***Do not drop or insert any objects*** into the ventilation openings.
- ***If considerable amounts of dust, water, or fluids enter the system***, turn off the power supply immediately, unplug the power cord, and contact the system vendor.
- **DO NOT:**
 - Drop the system against a hard surface.
 - Strike or exert excessive force onto the LCD panel.
 - Touch any of the LCD panels with a sharp object
 - In a site where the ambient temperature exceeds the rated temperature

DRPC-230-ULT5 Embedded System

B.1.2 Anti-static Precautions



WARNING:

Failure to take ESD precautions during the installation of the DRPC-230-ULT5 may result in permanent damage to the DRPC-230-ULT5 and severe injury to the user.

Electrostatic discharge (ESD) can cause serious damage to electronic components, including the DRPC-230-ULT5. Dry climates are especially susceptible to ESD. It is therefore critical that whenever the DRPC-230-ULT5 is opened and any of the electrical components are handled, the following anti-static precautions are strictly adhered to.

- **Wear an anti-static wristband:** Wearing a simple anti-static wristband can help to prevent ESD from damaging any electrical component.
- **Self-grounding:** Before handling any electrical component, touch any grounded conducting material. During the time the electrical component is handled, frequently touch any conducting materials that are connected to the ground.
- **Use an anti-static pad:** When configuring or working with an electrical component, place it on an anti-static pad. This reduces the possibility of ESD damage.
- **Only handle the edges of the electrical component:** When handling the electrical component, hold the electrical component by its edges.

B.1.3 Explanation of Graphical Symbols



This symbol warns the user that the part has this symbol is hot. Therefore, it is dangerous to make any kind of contact with this part.



This symbol alerts the user that important information concerning the operation and maintenance of this unit has been included. Therefore, the information should be read carefully in order to avoid any problems.

B.1.4 Product Disposal

**CAUTION:**

Risk of explosion if the battery is replaced by an incorrect type;

Replacement of a battery with an incorrect type that can defeat a safeguard (for example, in the case of some lithium battery types);

Disposal of a battery into fire or a hot oven, or mechanically crushing or cutting of a battery, that can result in an explosion;

Leaving a battery in an extremely high temperature surrounding environment that can result in an explosion or the leakage of flammable liquid or gas;

A battery subjected to extremely low air pressure that may result in an explosion or the leakage of flammable liquid or gas.

Dispose of used batteries according to instructions and local regulations.

- Outside the European Union - If you wish to dispose of used electrical and electronic products outside the European Union, please contact your local authority so as to comply with the correct disposal method.
- Within the European Union:

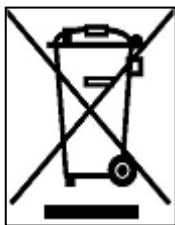

EU-wide legislation, as implemented in each Member State, requires that waste electrical and electronic products carrying the mark (left) must be disposed of separately from normal household waste. This includes monitors and electrical accessories, such as signal cables or power cords. When you need to dispose of your display products, please follow the guidance of your local authority, or ask the shop where you purchased the product. The mark on electrical and electronic products only applies to the current European Union Member States.

Please follow the national guidelines for electrical and electronic product disposal.

DRPC-230-ULT5 Embedded System

B.2 Maintenance and Cleaning Precautions

When maintaining or cleaning the DRPC-230-ULT5, please follow the guidelines below.

B.2.1 Maintenance and Cleaning

Prior to cleaning any part or component of the DRPC-230-ULT5, please read the details below.

- The interior of the DRPC-230-ULT5 does not require cleaning. Keep fluids away from the DRPC-230-ULT5 interior.
- Be cautious of all small removable components when vacuuming the DRPC-230-ULT5.
- Turn the DRPC-230-ULT5 off before cleaning the DRPC-230-ULT5.
- Never drop any objects or liquids through the openings of the DRPC-230-ULT5.
- Be cautious of any possible allergic reactions to solvents or chemicals used when cleaning the DRPC-230-ULT5.
- Avoid eating, drinking and smoking within vicinity of the DRPC-230-ULT5.

B.2.2 Cleaning Tools

Some components in the DRPC-230-ULT5 may only be cleaned using a product specifically designed for the purpose. In such case, the product will be explicitly mentioned in the cleaning tips. Below is a list of items to use when cleaning the DRPC-230-ULT5.

- **Water or rubbing alcohol** – A cloth moistened with water or rubbing alcohol can be used to clean the DRPC-230-ULT5.
- **Using solvents** – The use of solvents is not recommended when cleaning the DRPC-230-ULT5 as they may damage the plastic parts.
- **Vacuum cleaner** – Using a vacuum specifically designed for computers is one of the best methods of cleaning the DRPC-230-ULT5. Dust and dirt can restrict the airflow in the DRPC-230-ULT5 and cause its circuitry to corrode.
- **Swabs** - Swabs moistened with rubbing alcohol or water are excellent tools for wiping hard to reach areas. Whenever possible, it is best to use lint free swabs such as foam swabs for cleaning.

Appendix

C

Digital I/O Interface

DRPC-230-ULT5 Embedded System

The DIO connector on the DRPC-230-ULT5 is interfaced to GPIO ports on the Super I/O chipset. The DIO has both 8-bit digital inputs and 8-bit digital outputs. The digital inputs and digital outputs are generally control signals that control the on/off circuit of external devices or TTL devices. Data can be read or written to the selected address to enable the DIO functions.



NOTE:

For further information, please refer to the datasheet for the Super I/O chipset.

The BIOS interrupt call **INT 15H** controls the digital I/O.

INT 15H:

AH – 6FH	
<u>Sub-function:</u>	
AL – 8	:Set the digital port as INPUT
AL	:Digital I/O input value

Assembly Language Sample 1

```
MOV    AX, 6F08H    ;setting the digital port as input
INT    15H        ;
```

AL low byte = value

AH – 6FH	
<u>Sub-function:</u>	
AL – 9	:Set the digital port as OUTPUT
BL	:Digital I/O output value

Assembly Language Sample 2

```
MOV    AX, 6F09H      ;setting the digital port as output  
MOV    BL, 09H        ;digital value is 09H  
INT    15H           ;
```

Digital Output is 1001b

Appendix

D

Watchdog Timer



NOTE:

The following discussion applies to DOS. Contact IEI support or visit the IEI website for drivers for other operating systems.

The Watchdog Timer is a hardware-based timer that attempts to restart the system when it stops working. The system may stop working because of external EMI or software bugs. The Watchdog Timer ensures that standalone systems like ATMs will automatically attempt to restart in the case of system problems.

A BIOS function call (INT 15H) is used to control the Watchdog Timer.

INT 15H:

AH – 6FH Sub-function:	
AL – 2:	Sets the Watchdog Timer’s period.
BL:	Time-out value (Its unit-second is dependent on the item “Watchdog Timer unit select” in CMOS setup).

Table D-1: AH-6FH Sub-function

Call sub-function 2 to set the time-out period of Watchdog Timer first. If the time-out value is not zero, the Watchdog Timer starts counting down. When the timer value reaches zero, the system resets. To ensure that this reset condition does not occur, calling sub-function 2 must periodically refresh the Watchdog Timer. However, the watchdog timer is disabled if the time-out value is set to zero.

A tolerance of at least 10% must be maintained to avoid unknown routines within the operating system (DOS), such as disk I/O that can be very time-consuming.

DRPC-230-ULT5 Embedded System

**NOTE:**

The Watchdog Timer is activated through software. The software application that activates the Watchdog Timer must also deactivate it when closed. If the Watchdog Timer is not deactivated, the system will automatically restart after the Timer has finished its countdown.

EXAMPLE PROGRAM:

; INITIAL TIMER PERIOD COUNTER

;

W_LOOP:

;

```

MOV      AX, 6F02H      ;setting the time-out value
MOV      BL, 30         ;time-out value is 48 seconds
INT      15H

```

;

; ADD THE APPLICATION PROGRAM HERE

;

```

CMP      EXIT_AP, 1     ;is the application over?
JNE      W_LOOP        ;No, restart the application

MOV      AX, 6F02H     ;disable Watchdog Timer
MOV      BL, 0         ;
INT      15H

```

;

; EXIT ;

Appendix

E

Error Beep Code

DRPC-230-ULT5 Embedded System

E.1 PEI Beep Codes

Number of Beeps	Description
1	Memory not Installed
1	Memory was installed twice (InstallPeiMemory routine in PEI Core called twice)
2	Recovery started
3	DXE IPL was not found
3	DXE Core Firmware Volume was not found
4	Recovery failed
4	S3 Resume failed
7	Reset PPI is not available

E.2 DXE Beep Codes

Number of Beeps	Description
1	Invalid password
4	Some of the Architectural Protocols are not available
5	No Console Output Devices are found
5	No Console Input Devices are found
6	Flash update is failed
7	Reset protocol is not available
8	Platform PCI resource requirements cannot be met



NOTE:

If you have any question, please contact IEI for further assistance.

Appendix

F

Hazardous Materials Disclosure

DRPC-230-ULT5 Embedded System

F.1 RoHS II Directive (2015/863/EU)

The details provided in this appendix are to ensure that the product is compliant with the RoHS II Directive (2015/863/EU). The table below acknowledges the presences of small quantities of certain substances in the product, and is applicable to RoHS II Directive (2015/863/EU).

Please refer to the following table.

Part Name	Toxic or Hazardous Substances and Elements									
	Lead (Pb)	Mercury (Hg)	Cadmium (Cd)	Hexavalent Chromium (CR(VI))	Polybrominated Biphenyls (PBB)	Polybrominated Diphenyl Ethers (PBDE)	Bis(2-ethylhexyl) phthalate (DEHP)	Butyl benzyl phthalate (BBP)	Dibutyl phthalate (DBP)	Diisobutyl phthalate (DIBP)
Housing	O	O	O	O	O	O	O	O	O	O
Display	O	O	O	O	O	O	O	O	O	O
Printed Circuit Board	O	O	O	O	O	O	O	O	O	O
Metal Fasteners	O	O	O	O	O	O	O	O	O	O
Cable Assembly	O	O	O	O	O	O	O	O	O	O
Fan Assembly	O	O	O	O	O	O	O	O	O	O
Power Supply Assemblies	O	O	O	O	O	O	O	O	O	O
Battery	O	O	O	O	O	O	O	O	O	O

O: This toxic or hazardous substance is contained in all of the homogeneous materials for the part is below the limit requirement in Directive (EU) 2015/863.

X: This toxic or hazardous substance is contained in at least one of the homogeneous materials for this part is above the limit requirement in Directive (EU) 2015/863.

F.2 China RoHS

此附件旨在确保本产品符合中国 RoHS 标准。以下表格标示此产品中某有毒物质的含量符合中国 RoHS 标准规定的限量要求。

本产品上会附有“环境友好使用期限”的标签，此期限是估算这些物质“不会有泄漏或突变”的年限。本产品可能包含有较短的环境友好使用期限的可替换元件，像是电池或灯管，这些元件将会单独标示出来。

部件名称	有毒有害物质或元素					
	铅 (Pb)	汞 (Hg)	镉 (Cd)	六价铬 (CR(VI))	多溴联苯 (PBB)	多溴二苯醚 (PBDE)
壳体	○	○	○	○	○	○
显示	○	○	○	○	○	○
印刷电路板	○	○	○	○	○	○
金属螺帽	○	○	○	○	○	○
电缆组装	○	○	○	○	○	○
风扇组装	○	○	○	○	○	○
电力供应组装	○	○	○	○	○	○
电池	○	○	○	○	○	○
<p>○: 表示该有毒有害物质在该部件所有物质材料中的含量均在 SJ/T11364-2014 與 GB/T26572-2011 标准规定的限量要求以下。</p> <p>X: 表示该有毒有害物质至少在该部件的某一均质材料中的含量超出 SJ/T11364-2014 與 GB/T26572-2011 标准规定的限量要求。</p>						