



Quick Start Guide for iP-8000-MRTU

May 2014, Version 1.0.1

Congratulations!

Congratulations on purchasing iP-8000-MRTU - the most popular automation solution for remote monitoring and control application. This Quick Start Guide will provide information needed to get started.

What's In the Box?

In addition to this guide, the package includes the following items:



iP-8000-MRTU
(iP-8411-MRTU/iP-8811-MRTU)



Software Utility CD



RS-232 Cable
(CA-0915)



Screw Driver
(1C016)

Technical Support

- **iP-8000-MRTU Reference Document**
CD:\Napdos\Modbus\IP8000R\Document\
<http://ftp.icpdas.com/pub/cd/8000cd/napdos/modbus/ip8000r/document/>
- **iP-8000-MRTU Website**
<http://www.icpdas.com/root/product/solutions/pac/ipac/ip-8x11-mrtu.html>
- **ICP DAS Website**
<http://www.icpdas.com/>

1 Mounting the Hardware

The iP-8000-MRTU installation must provide proper ventilation, spacing, and grounding to ensure the equipment will operate as specified. A minimum clearance of 50mm between the iP-8000-MRTU and the top and bottom side of the enclosure panels must be provided.

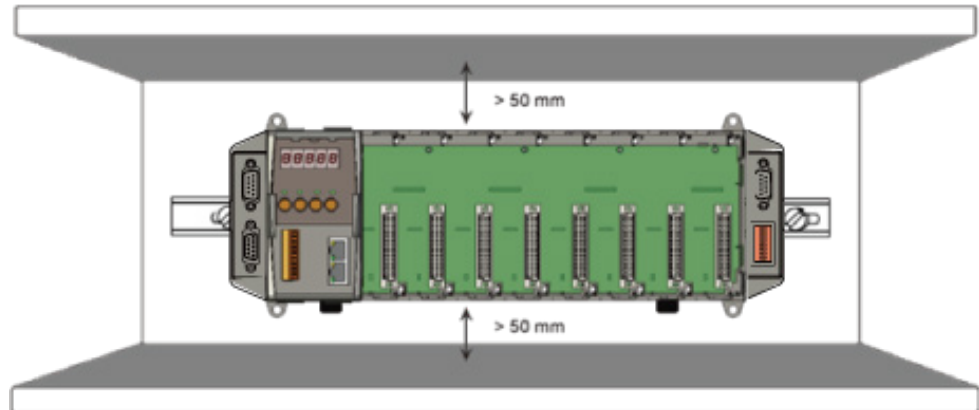

2 Configure the Boot Mode

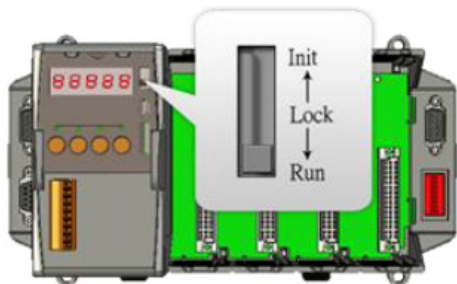

Before starting any installation, be sure that the DIP switch is placed in the “Run” position.

3 Connecting to PC and Setting up the Power

- Connect **PC** to **COM1** through a **RS-232** cable.
- Connect the **+24 V_{DC} power supply** to **PWR1** and **GND** terminals.

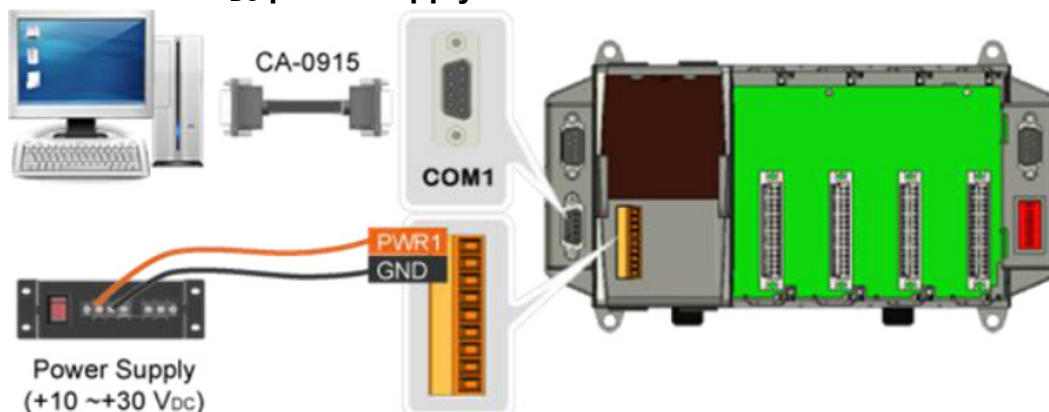

4 Inserting and Wiring the I/O Modules

There are various types of I/O expansion modules for interfacing many different field devices to the iP-8000-MRTU.

For more information about I/O expansion module, please refer to

http://www.icpdas.com/products/PAC/xpac/remote_io_support_list.htm

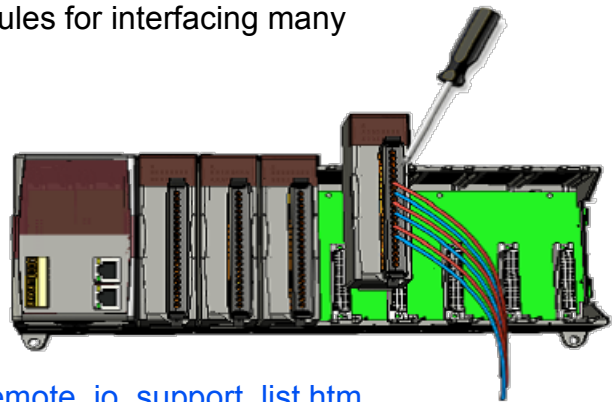

5 Setting the Net ID

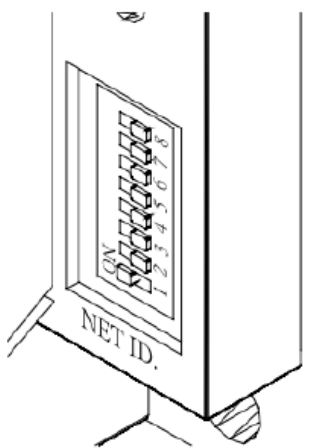

The Net ID must be unique in the network. It can be from 01 to FF. This 8-bit DIP switch allow you to change the Net ID. After setting the Net ID, the iP-8000-MRTU must be rebooted to apply the new Net ID.

Net ID	1	2	3	4	5	6	7	8
01	On	-	-	-	-	-	-	-
02	-	On	-	-	-	-	-	-
03	On	On	-	-	-	-	-	-
04	-	-	On	-	-	-	-	-
05	On	-	On	-	-	-	-	-

6 Installing the Modbus Utility



Modbus_Uti...

The Modbus Utility can be obtained from companion CD or ICP DAS FTP site:

CD:\Napdos\Modbus\Modbus_UTILITY\

ftp://ftp.icpdas.com/pub/cd/8000cd/napdos/modbus/modbus_utility/

7 Using the Modbus Utility to Configure the Module

The Modbus Utility can be used to make the communication between the iP-8000-MRTU and PC/Laptop via the Modbus RTU/ASCII protocol.

Step 1: Run the Modbus Utility and connect to iP-8000-MRTU.

i. Double-click the **Modbus Utility** shortcut on the desktop.

ii. Click the **Modbus/RTU** button in the middle of the **Select Controller** dialog.



iii. Select the COM port, and then click the **Connect** button. Click the **Search** button in the Search List dialog box to scan the Net ID of iP-8000-MRTU on the COM port.

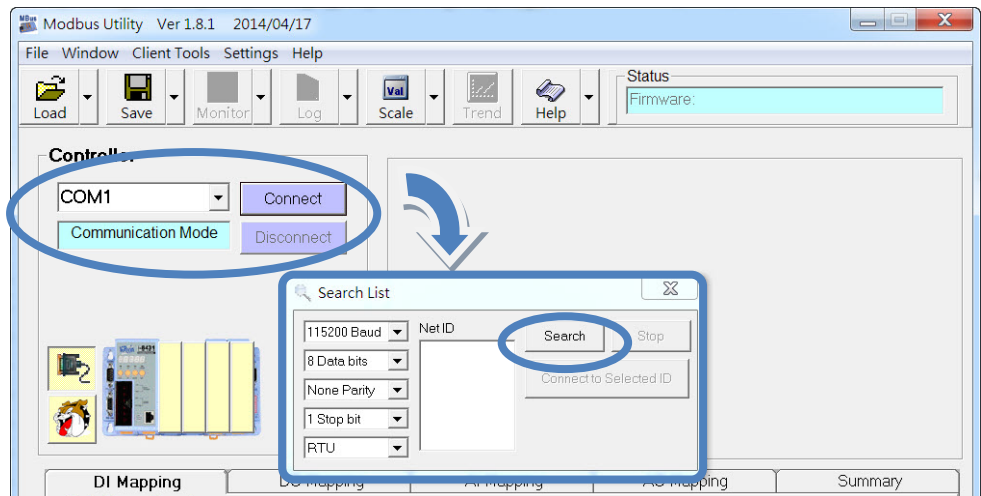

iv. If the Net ID of iP-8000-MRTU was found, click the **Stop** button first, and then select the Net ID and click the **Connect to Selected ID** button to connect. The default value for COM1 of iP-8000-MRTU is 115200, N, 8, 1, RTU Mode.

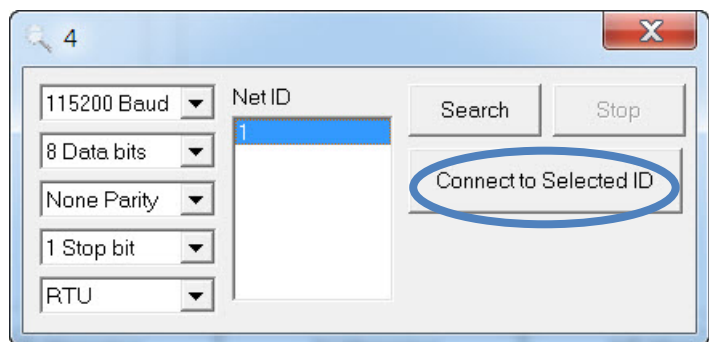

Step 2: Match the I/O module and then get the I/O configuration information.

i. Click the **Refresh** button to match the I/O modules to configuration of the controller.

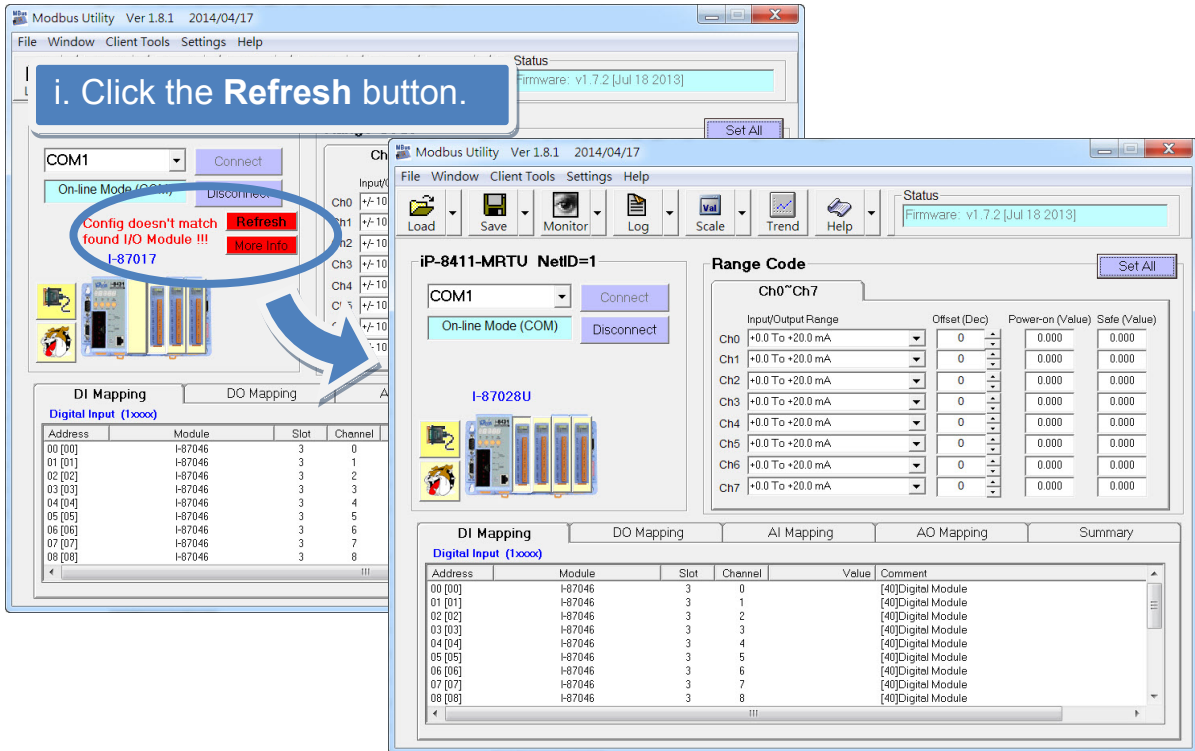

ii. Select the **About** option from the **Help** menu to get the I/O configuration and firmware information.

iii. Check the module status diagram, ensuring for the I/O modules to be matched.

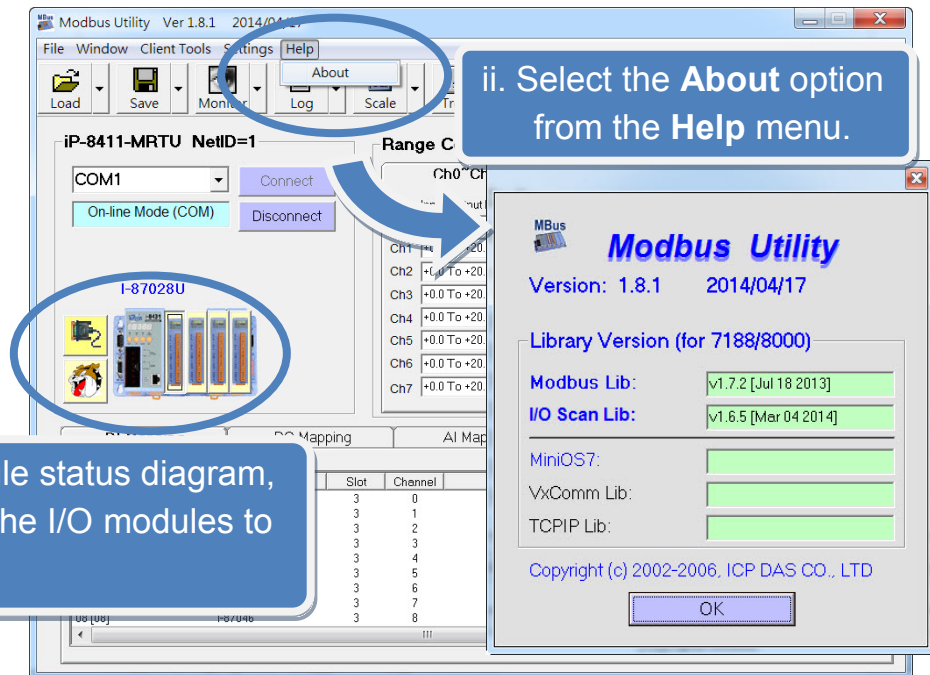

iii. See the module status diagram, ensuring for the I/O modules to be matched.

Step 3: Set I/O configuration, get the I/O values and then save the I/O configuration.

i. Configure the I/O settings, such as Range Code, Power-on and Safe values.

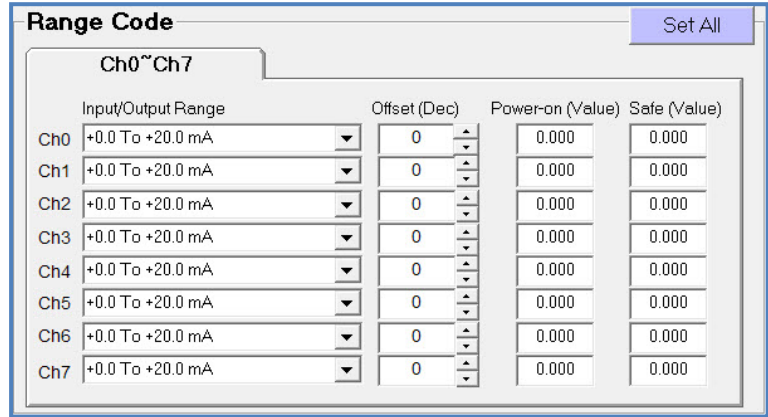

ii. Select the **Timer Interval** from the **Monitor** menu to set the monitoring interval.

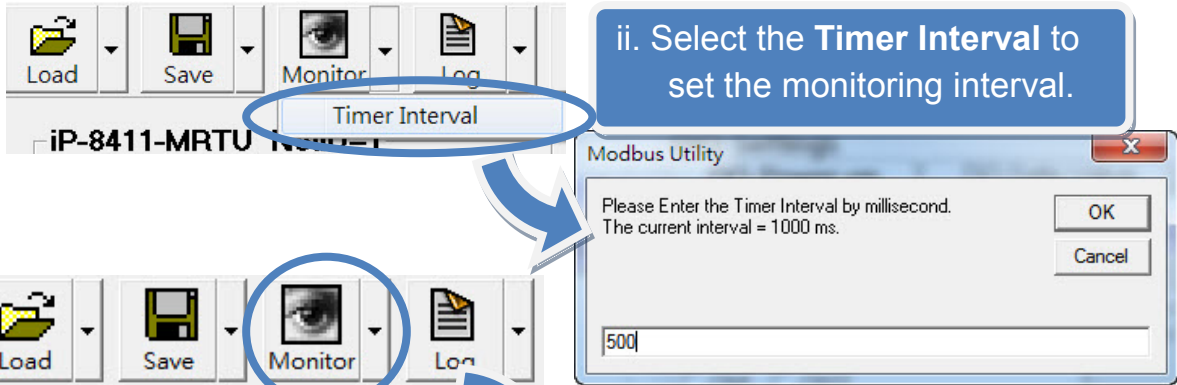

iii. Click the **Monitor** icon to start retrieving I/O values. The I/O values will be displayed in the Mapping tables.

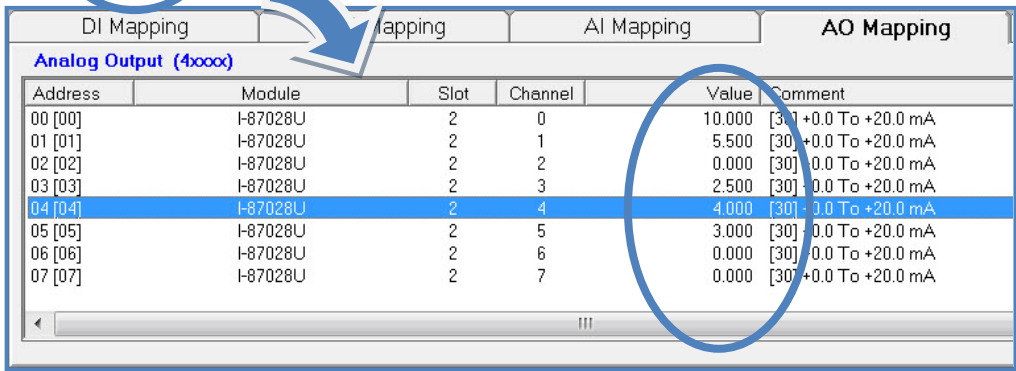

iv.

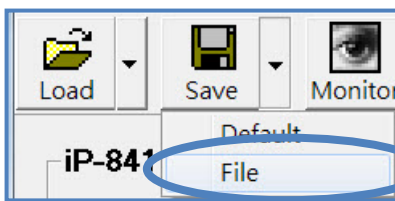

Select **File** option from the **Save** menu and select a location where the configuration file is about to be saved. This operation can save the controller configuration and I/O settings to an "ini" file, and the file can be loaded by **Load** function at the next time when using the same controller and I/O modules.

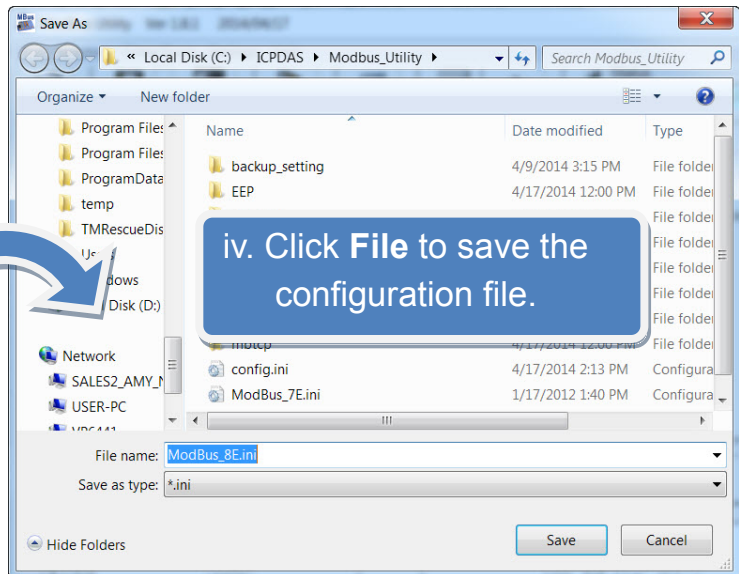

8 Q & A

1. How do I know the COM Port settings?

The COM Port setting will be displayed on the 7-seg LED.

The first number is the COM Port number. This example shows the settings of COM1 are 115200 Baud Rate, 8 Data Bits, None Parity, 1 Stop Bit and Modbus RTU Slave Mode. The COM Port settings can be configured with the Modbus Utility. The new settings will take effect after rebooting the iP-8000-MRTU.



The figure of ASCII Mode shows as left-hand side. (COM1, Mode= Modbus ASCII)

2. How could I set the COM Port to the Modbus RTU Slave Mode?

Step1: Run the Modbus Utility and connect to the iP-8000-MRTU.

Step2: Click the **COM Port icon** to display the setting area.

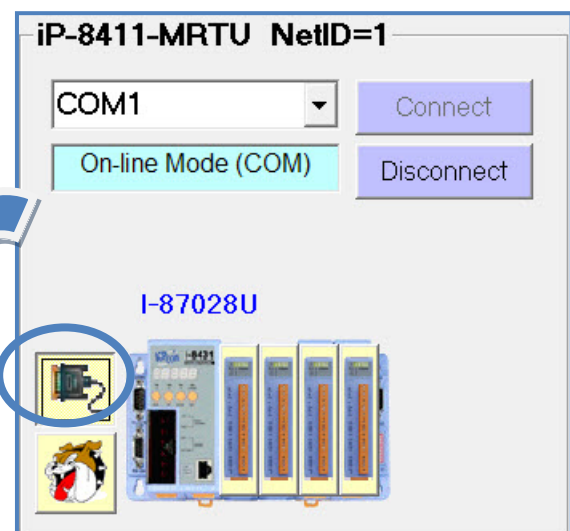
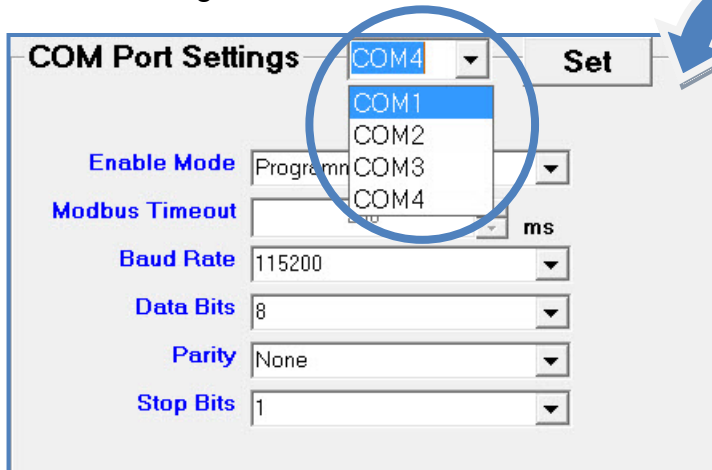

Step3: Select the **COM Port** from the drop-down list.

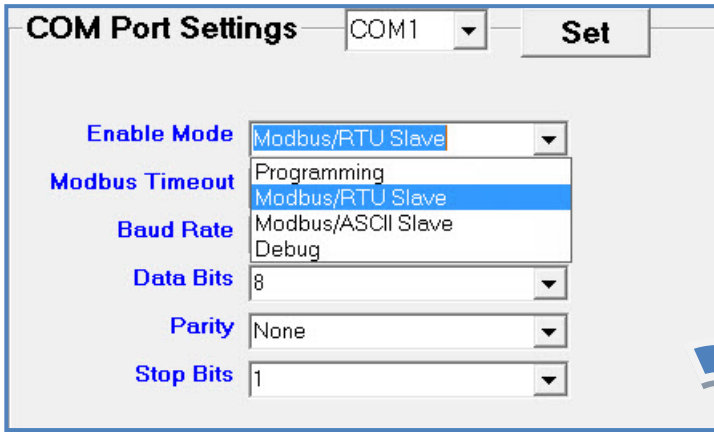

Step4: Select the **Enable Mode** to Modbus/RTU Slave, and set the **Modbus Timeout, Baud Rate, Data Bits, Parity and Stop Bits**.

Step5: Click the **Set** button to apply for new settings.

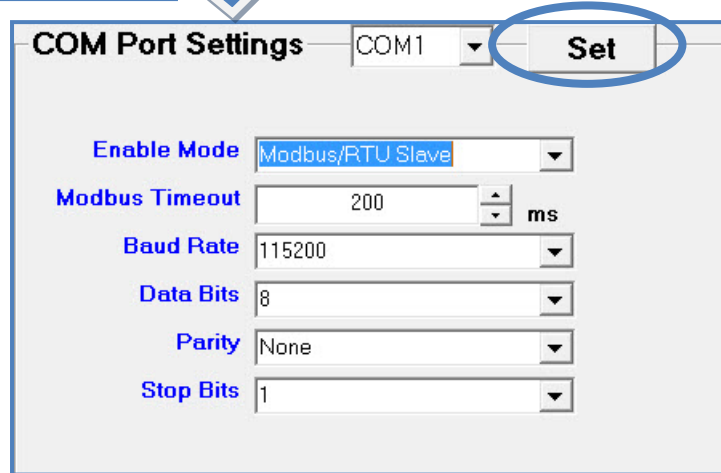

3.How do I reset the COM Port to the default value?

Step1: Go to 7-seg LED, press the **MODE** and **SET** buttons simultaneously for about 2 seconds.

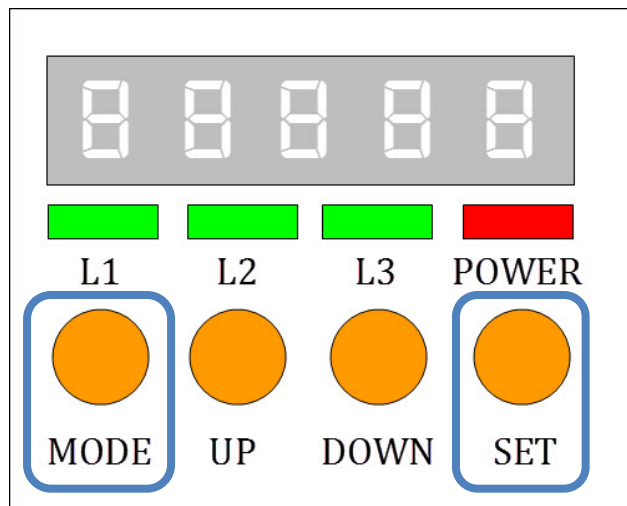

Step2: Wait for 2 seconds, the word “RESET” appeared. Press the buttons until the LED is flickering, and then the COM Ports are **all** set to default values. The default COM Port values are 115200, N, 8, 1, RTU Mode.

