ISaGRAF WinCE ViewPAC User Manual

[Version: V.1.6]

ViewPAC Models:

VP-25W7 , VP-23W7 , VP-4137

VP-25W6 , VP-23W6 , VP-4136



**** The ISaGRAF WinCE ViewPAC in this manual include: (abbreviation: VP-2xxW7/4xx7)**
VP-25W7, VP-23W7, VP-4137 (Support ISaGRAF logic running in the PAC)
VP-25W6, VP-23W6, VP-4136 (Support InduSoft & ISaGRAF logic running in the same PAC)

Important Notice

1. Please store your application programs and data files in the \Micro_SD . Don't store them in the \System_disk. That is because the \System_Disk is using Nor Flash memory. Its size is small and major purpose is for storing OS, ISaGRAF driver, some basic utilities and DLL . The Nor Flash memory is not good for frequently updating files. If update files frequently in the \System_Disk (for example, update a file every 1 to 5 seconds, then it will be about ten thousand more updates in one day), the data or files in the \System_disk may crush or lost for some days or months later.
2. ISaGRAF WinCE ViewPAC support only High profile I-8K and I-87K I/O cards in its slot 0 to 2. Please refer to the accompanying CD-ROM: \napdos\isagraf\vp-25w7-23w7\english-manu\ Datasheet files.
3. Please always set a **fixed IP** address to the ISaGRAF WinCE ViewPAC. (**No DHCP**). Recommend to use the NS-205/208 or RS-405/408 (Ring Switch) Industrial Ethernet Switch for them.

Legal Liability

ICP DAS CO., LTD. assumes no liability for any and all damages that may be incurred by the user as a consequence of this product. ICP DAS CO., LTD. reserves the right to change this manual at any time without notice.

ICP DAS CO., LTD. constantly strives to provide our customers with the most reliable and accurate information possible regarding our products. However, ICP DAS CO., LTD. assumes no responsibility for its use, or for any infringements of patents or other rights of third parties resulting from its use.

Trademark & Copyright Notice

The names of products and name of company are used for identification purposes only, and are the registered trademarks of their respective owners or companies.

Development Software

Two options:

- ISaGRAF: Ver. 3.4x (or Ver. 3.5x), IEC61131-3 standard. LD, ST, FBD, SFC, IL & FC or
- Non-ISaGRAF: Microsoft EVC++4.0 or VS.NET 2008/2005/2003 (VB.net, C#.net)

Reference Guide

- ISaGRAF English User's Manual:
VP-25W7/23W7 CD: \napdos\isagraf\vp-25w7-23w7\english-manu\
"user_manual_i_8xx7.pdf" and "user_manual_i_8xx7_appendix.pdf"
- ISaGRAF中文進階使用手冊:
VP-25W7/23W7 CD: \napdos\isagraf\vp-25w7-23w7\chinese-manu\
"chinese_user_manual_i_8xx7.pdf" and "chinese_user_manual_i_8xx7_appendix.pdf"
- More from the Internet:
www.icpdas.com > [Product](#) > [Solutions](#) > [Soft PLC, ISaGRAF & Soft-GRAF HMI](#) > [ISaGRAF](#) > [Manual](#)

Technical Service

service@icpdas.com.

FAQ : www.icpdas.com > [Support](#) > [FAQ](#) > [ISaGRAF Soft-Logic PAC](#)

Writer: Chun Tsai,

Last Editor: Eva Li

Copyright Jul. 2009, by ICP DAS CO., LTD. All Rights Reserved.

Table of Contents

ISaGRAF WinCE ViewPAC User Manual	1
Important Notice.....	2
Legal Liability.....	2
Trademark & Copyright Notice	2
Development Software	2
Reference Guide.....	2
Technical Service.....	2
Table of Contents.....	3
Reference Guide	6
I/O Modules Selection Guide for ISaGRAF WinCE ViewPAC.....	7
Specifications: VP-25W7 / VP-23W7 / VP-4137	11
Chapter 1 Typical Application	1-1
1.1 Soft-GRAF HMI Application: Colorful HMI.....	1-1
1.2 eLogger HMI Application	1-2
1.3 Redundant Communication System	1-3
1.4 New Hot-Swap and Redundant System	1-3
1.5 Modbus Master: RTU, ASCII, RS-232/485/422	1-4
1.6 Modbus Master: TCP/IP	1-4
1.7 Modbus Slave: RTU/TCP	1-5
1.8 Communicate With Other TCP/IP Server or UDP Client/Server Devices	1-5
1.9 Multiple Web HMI – Monitor & Control Everywhere!.....	1-6
1.10 Send Email with One Attached File	1-6
1.11 Data-Recorder & Data-Logger	1-7
1.12 Remote I/O Application	1-7
1.13 SMS: Short Message Service.....	1-8
1.14 As a Modbus Gateway for the Remote I/O Modules	1-8
1.15 Motion Control	1-9
1.16 Stress Monitoring Application of Constructions	1-9
1.17 Fast FRnet Remote I/O	1-10
1.18 Integrate with CAN/CANopen Devices & Sensors.....	1-10
1.19 VIP Communication Security	1-11
1.20 ISaGRAF PAC Connects the Smart Power Meter	1-11
1.21 ZigBee Wireless Solution	1-12
1.22 GPS Application: ISaGRAF PAC Plus I-87211W or GPS-721	1-13
1.23 Data Exchange: Ebus.....	1-14
1.24 Detect Hot-Swap I-87K (High Profile) I/O Status	1-14
1.25 Database Application.....	1-15
1.26 HART Solutions	1-16
1.27 2G/3G Wireless Application	1-17
1.28 Measure humidity and temperature values via DL-100TM485	1-18
Chapter 2 Software Installation And Working Soft-GRAF HMI with ISaGRAF.....	2-1
2.1 Step 1 - Installing The ISaGRAF Software	2-2
2.1.1 The Hardware Protection Device (Dongle & USB Key-Pro).....	2-3
2.1.2 Important Notice For Window 2000 Users	2-4
2.1.3 Important Notice for Window NT Users	2-4
2.1.4 Important Notice for Windows Vista or Windows 7 (32-bit) Users.....	2-5

2.1.5	Important Notice for Windows 7 (64-bit) Users	2-7
2.1.6	Important Setting for Using Variable Arrays	2-7
2.2	Step 2 - Installing The ICP DAS Utilities For ISaGRAF.....	2-8
2.3	Step 3 - Installing The Web Page Editor	2-9
2.4	Working eLogger HMI with ISaGRAF SoftLogic	2-9
2.5	Working Soft-GRAF HMI with ISaGRAF SoftLogic.....	2-10
Chapter 3	Setting Up A Web HMI Demo.....	3-1
3.1	Web Demo List	3-1
3.2	Steps To Set Up A Web HMI Demo	3-2
3.2.1	Step 1 – Set up The Hardware	3-2
3.2.2	Step 2 - Setting The Web Options	3-2
3.2.3	Step 3 - Download ISaGRAF Project	3-3
3.2.4	Step 4 - Download Web Pages To The ViewPAC	3-6
3.2.5	Step 5 - Show Time	3-6
Chapter 4	Programming A Web HMI Example	4-1
4.1	Writing A Simple ISaGRAF Program.....	4-2
4.1.1	Open ISaGRAF-Project Management	4-3
4.1.2	Creating An ISaGRAF User’s Group.....	4-3
4.1.3	Creating A New ISaGRAF Project	4-4
4.1.4	Declaring The ISaGRAF Project Variables	4-5
4.1.5	Assign Modbus Network Address No to Variables.....	4-8
4.1.6	Create The LD - "LD1" Program	4-10
4.1.7	Edit The "LD1" Program.....	4-11
4.1.8	Connecting The I/O.....	4-14
4.2	Compiling & Simulating The Example Project	4-16
4.3	Download & Debug The Example Project	4-20
4.4	Design The Web Page	4-24
4.4.1	Step 1 – Copy The Sample Web HMI pages	4-24
4.4.2	Step 2 – Building The Main.htm	4-25
4.4.3	Step 3 – Adding Control Code To The Main.htm.....	4-30
4.4.4	Step 4 – Download Web HMI Pages To The Controller.....	4-37
Chapter 5	Web HMI Basics	5-1
5.1	Basic Files For The Web HMI	5-1
5.2	Login.htm.....	5-2
5.3	menu.htm	5-4
5.4	main.htm	5-6
5.4.1	A Simple Main.htm Example	5-6
5.4.2	More About The refresh_data() Function And Dynamic Data	5-8
5.4.3	Post Data To The Controller	5-13
5.5	Multi-Pages.....	5-17
5.5.1	Level 2 And Level 3 Page	5-17
5.5.2	Switch One Page To One Another Page	5-18
5.6	Web Security	5-19
Chapter 6	VB.NET 2008 Program Access To ISaGRAF Variables	6-1
6.1	Create a New Project.....	6-1
6.2	Add Project Reference for an Application.....	6-3
6.3	Compiling an Application Program.....	6-5
6.4	QuickerNET.DLL	6-6
6.4.1	Digital R/W Functions	6-6

6.4.2	Analog R/W Functions	6-8
Chapter 7	EVC++ Program Access To ISaGRAF Variables.....	7-1
Chapter 8	InduSoft Project Access To ISaGRAF Variables	8-1
Chapter 9	Example Program & FAQ.....	9-1
9.1	Get On-Line help.....	9-1
9.2	Installing The ISaGRAF Programming Examples.....	9-4
9.3	Frequently Asked Questions.....	9-11
Chapter 10	C# .NET 2008 Program Access To ISaGRAF Variables	10-1
10.1	Create a New Project.....	10-1
10.2	Add Project Reference for an Application.....	10-3
10.3	Compiling an Application Program.....	10-5
10.4	QuickerNET.DLL	10-5
10.4.1	Digital R/W Functions	10-6
10.4.2	Analog R/W Functions	10-7
Chapter 11	More Useful Features	11-1
11.1	FAQ-167: Develop Your Own C-function and C-function Blocks in the ISaGRAF WinCE PAC	11-1
11.2	FAQ-166: ISaGRAF WinCE PAC - Schedule Control.....	11-2
11.3	FAQ-160: Soft-GRAF Application - Alarm Lists	11-3
11.4	FAQ-158: Soft-GRAF Application - Data Logger.....	11-4
Appendix A	Hardware System & Setting	1
A.1	Applying Correct Power Supply	1
A.2	Modify The NET-ID & Modbus RTU Port Setting.....	3
A.3	Setting The IP Address For The ViewPAC	4
A.4	Connecting Your PC To The ViewPAC Ethernet Port.....	5
A.5	Pin Assignment of COM2 , COM3 and Multi-Clients.....	6
A.6	Connecting PC To VP-2xW7 's COM2 or COM3.....	7
A.7	Deleting the ISaGRAF Project From The ViewPAC	8
A.8	Linking I-7000 and I-87K Modules For Remote I/O	9
A.9	Linking To An HMI Interface Device	9
A.10	Linking To Other Modbus Devices.....	10
A.11	Recalibrate The Touch Screen Of VP-25W7	11
Appendix B	Upgrade ISaGRAF Driver to Newer Version.....	13
Appendix C	Hardware Interface & Dimension.....	16
Appendix D	Enable The Second Ethernet Port Of The VP-2xW7/2xW6/4137/4136	21
Appendix E	Using Expansion RS-232/485/422	23
Appendix F	Slow Down ISaGRAF Driver's Speed	26
Appendix G	Setup More Modbus RTU Salve Ports.....	27
Appendix H	Compiling Error Result In Different ISaGRAF Version	28
Appendix I	Why my PC running ISaGRAF cannot connect the ISaGRAF PAC correctly ?.....	29
Appendix J	Control Buttons On the Front Panel	30
Appendix K	Enable the Screen Saver of ViewPAC.....	31
Appendix L	How to Detect the Status of Dual Battery and the Ethernet Port	32

Reference Guide

ISaGRAF English User's Manual:

ISaGRAF WinCE ViewPAC CD: \napdos\isagraf\vp-25w7-23w7\english-manu\
"user_manual_i_8xx7.pdf" and "user_manual_i_8xx7_appendix.pdf"

ISaGRAF 中文進階使用手冊:

ISaGRAF WinCE ViewPAC CD: \napdos\isagraf\vp-25w7-23w7\chinese-manu\
"chinese_user_manual_i_8xx7.pdf" and "chinese_user_manual_i_8xx7_appendix.pdf"

Web: www.icpdas.com > [Product](#) > [Solutions](#) > [Soft PLC, ISaGRAF & Soft-GRAF HMI](#) > [ISaGRAF](#) > [Manual](#)

Industrial Ethernet Switch : NS-205/208 or RS-405/408 (Ring Switch)

www.icpdas.com > [Product](#) > [Solutions](#) > [Industrial Ethernet Switch & Fber Switch](#) > [Unmanaged Ethernet Switches](#)



Model: NS-205



Model: NS-208



Model: RS-405



Model: RS-408

Power Supply :

www.icpdas.com > [Product](#) > [Solutions](#) > [Accessories](#) > [Power Supply](#)

DP-660 : 24 V / 2.5 A , 5 V / 0.5 A power supply (DIN-Rail mounting)

DP-665 : 24 V / 2.5 A , 5 V / 0.5 A power supply

DP-1200 : 24 V / 5 A power supply



Model: DP-660



Model: DP-1200



Model: DP-665

FAQ:

www.icpdas.com > [Support](#) > [FAQ](#) > [ISaGRAF Soft-Logic PAC](#)

I/O Modules Selection Guide for ISaGRAF WinCE ViewPAC

ISaGRAF WinCE ViewPAC support only the I-8K / I-87K High Profile I/O modules and RS-485 / FRnet remote I/O modules listed in the [ISaGRAF Data Sheet](#) . Please refer to the list in the next page or follow the below steps to get the newest list.



Home > Product > Solutions > Soft PLC, ISaGRAF & Soft-GRAF HMI > Download - Data Sheet/Manual/Demo



中文
Introduction
What is ISaGRAF ?
Software Features
Applications
Ordering Information
Download
Driver
FAQ
Data Sheet
Manual
Demo Files
ISaGRAG PAC
XP-8xx7-Atom-CE6
XP-8xx7-CE6
WP-8x37/8x47
VP-2xW7/4xx7
WP-5147/5147-OD
VP-2117
IP-8x17/8x47
I-8x17/8x37-80
μPAC-5x07
μPAC-7186EG/7188XG

Download Center

中文

► Available soon ► Will be phased out.

Date Sheet

Products	I/O Selection	Size	Date
All PDF (ZIP)		13.1 MB	Aug-02-2013
Date Sheet: ISaGRAF	-	199 KB	Jul-30-2013
Date Sheet: Soft-GRAF Studio	-	192 KB	Jul-30-2013
Date Sheet: XPAC - Motion Control	-	190 KB	Jul-30-2013
Date Sheet: ISaGRAF PAC Applications	-	1.98 MB	Jul-30-2013
ISaGRAF WinCE PAC			
All WinCE PDF and I/O Selection (ZIP)		4.4 MB	Aug-02-2013
Date Sheet: XP-8xx7-CE6/XP-8xx7-Atom-CE6	-	1.67 MB	Jul-30-2013
Date Sheet: WP-8x37/8x47	-	1.45 MB	Jul-30-2013
Date Sheet: VP-25W7/23W7/4137 VP-4147		1.46 MB	Jul-30-2013
Date Sheet: WP-5147/5147-OD	-	1.2 MB	Aug-02-2013
ISaGRAF MiniOS7 PAC			

3. Data Sheet

High Speed Local I/O Modules: Parallel Bus**I-8K High Profile Modules: More at www.icpdas.com > [Product](#) > [Solutions](#) > [Remote I/O Modules/Units](#) > [I-8K & 87K](#)****I-8K Analog I/O Modules**

I-8014W	16-bit 250K sampling rate 8/16-ch. analog input module (The scan rate cannot reach 250K when using in the ISaGRAF PAC)
I-8017HW	8-ch. Differential or 16-ch. Single-ended, 14-bit, High Speed Analog Input Module. (current input require external 125 Ω resistor) (The scan rate cannot reach 100K when using in the ISaGRAF PAC)
I-8024W	4-ch. Isolated Analog Output Module (+/-10 V, 0 ~ +20 mA)

I-8K Digital I/O Modules

I-8037W	16-ch. Isolated Open Collector Output Module
I-8040W	32-ch. Isolated Digital Input Module
I-8040PW	32-ch. Isolated Digital Input with Low Pass Filter Module
I-8041W	32-ch. Isolated Open Collector Digital Output Module (Sink)
I-8041AW	32-ch. Isolated Open Collector Digital Output Module (Source)
I-8042W	16-ch. Isolated Digital Input & 16-ch. Isolated Open Collector Digital Output Module
I-8046W	16-ch. Isolated Digital Input Module
I-8050W	16-ch. Universal Digital I/O Module
I-8051W	16-ch. Non-isolated Digital Input Module
I-8052W	8-ch. Differential Isolated Digital Input Module
I-8053W	16-ch. Isolated Digital Input Module
I-8053PW	16-ch. Isolated Digital Input with Low Pass Filter Module
I-8054W	8-ch. Isolated Digital Input Module & 8-ch. Isolated Open Collector Digital Output Module
I-8055W	Non-isolated 8-ch. Digital Logic Input Module & 8-ch. Open Collector Digital Output Module
I-8056W	16-ch. Non-isolated Open Collector Output Module
I-8057W	16-ch. Isolated Open Collector Output Module
I-8058W	8-ch. Differential Isolated Digital Input Module, Max. AC/DC Input : 250V
I-8060W	6-ch. Relay Output Module, AC: 0.6 A @ 125 V , 0.3 A @ 250 V; DC: 2 A @ 30 V
I-8063W	4-ch. Differential Isolated digital input & 4-ch. Relay output module, AC : 0.6 A @ 125 V ; 0.3 A @ 250 V
I-8064W	8-ch. Power Relay Output Module, AC: 5 A @ 250 V, DC: 5 A @ 30 V
I-8068W	4-ch. Form-A, 5 A @ 250 V _{AC} /28 V _{DC} & 4-ch. Form-C, 5 A (NO) /3 A (NC) @ 277 V _{AC} /30 V _{DC} Relay Output Module
I-8069W	8-ch. PhotoMOS Relay Output Module, Max. AC/DC: 1 A @ 60 V

I-8K Counter/Frequency Modules

I-8084W	4-ch. Encoder, can be dir/pulse, or up/down or A/B phase (Quad. mode), Not support Encoder Z-index
I-8088W	8-ch. PWM Output and 8-ch. isolated DI Module, software support 1 Hz ~ 100 kHz (non-continuous).

I-8K Motion Modules

I-8093W	3-axis Encoder Module, max. 1M Hz for quadrant input mode, max. 4M Hz for pulse/direction and cw/ccw input model
I-8090W	3-axis Encoder Module
I-8091W	2-axis Stepping/Servo Motor Control Card without encoder input
I-8092F	High Speed 2-axis Motion Control Module, with FRnet Master (For XP-8xx7-CE6 only)
I-8094	High Speed 4-axis Motion Control Module (For XP-8xx7-CE6 only)
I-8094F	High Speed 4-axis Motion Control Module, with FRnet Master (For XP-8xx7-CE6 only)

I-8K Communication Modules

I-8112iW	2-ch. Isolated RS-232 Expansion Module
I-8114W	4-ch. non-isolated RS-232 Expansion Module
I-8114iW	4-ch. Isolated RS-232 Expansion Module
I-8142iW	2-ch. Isolated RS-422/485 Expansion Module
I-8144iW	4-ch. Isolated RS-422/485 Expansion Module

I-8172W	2-port FRnet Module
I-8K CAN Bus Modules	
I-8123W	1 Port High Performance CANopen Master Module

RS-485 Remote I/O Modules: Serial Interface; HOT-SWAP

I-87K High Profile Modules: More at www.icpdas.com > [Product](#) > [Solutions](#) > [Remote I/O Modules/Units](#) > [I-8K & 87K](#)

I-87K Analog I/O Modules

I-87005W	8-ch. Thermistor input and 8-ch. digital output module
I-87013W	4-ch., 16-bit, 10 Hz (Total), 2/3/4 Wire RTD Input Module with Open Wire Detection
I-87015W	7-ch., 16-bit, 12 Hz (Total), RTD Input Module with Open Wire Detection (for short sensor distance)
I-87015PW	7-ch. RTD Input Module with 3-wire RTD lead resistance elimination and with Open Wire Detection (for long sensor distance)
I-87017RW	8-ch. Differential , 16/12-bit, 10/60 Hz (Total) Analog Input Module with 240 V _{rms} Over Voltage Protection, Range of -20 ~ +20 mA Requires Optional External 125 Ω Resistor
I-87017RCW	8-ch. Differential , 16/12-bit, 10/60 Hz(Total) Current Input Module
I-87017W	8-ch. Analog Input Module
I-87017W-A5	8-ch. High Voltage Input Module
I-87017DW	8-ch. Analog Input Module (Gray Cover) (RoHS)
I-87017ZW	10/20-ch. Analog Input Module with High Voltage Protection (RoHS)
I-87018PW	8-ch. Thermocouple Input Module (Gray Cover) (RoHS)
I-87018RW	8-ch. Thermocouple Input Module. Recommend to use the better I-87018Z.
I-87018W	8-ch. Thermocouple Input Module. Recommend to use the better I-87018Z.
I-87018ZW	10-ch. Differential , 16-bit, 10 Hz (Total), Thermocouple Input Module with 240 V _{rms} Over Voltage Protection, Open Wire Detection, Range of +/-20 mA, 0~20 mA, 4~20 mA requires Optional External 125 Ω Resistor
I-87019PW	8-ch. Universal Analog Input Module (RoHS) (With a CN-1824 Daughter Board)
I-87019RW	8-ch. Diff. , 16-bit, 8 Hz (Total), Universal Analog Input Module with 240 V _{rms} Over Voltage Protection, Open Wire Detection (V, mA, Thermocouple; Range of -20 ~ +20 mA need to set Jumper on board)
I-87019ZW	10-ch. Universal Analog Input Module (Gray Cover) (RoHS), Includes the I-87019ZW Module and a DB-1820 Daughter Board
I-87024CW	4-ch. 12-bit channel to channel isolated current output module with open-wire detection
I-87024DW	4-ch. 14-bit analog output module
I-87024RW	4-ch. 14-bit analog output module
I-87024W	4-ch. 14-bit analog output module (0 ~ +5 V, +/-5 V, 0 ~ +10 V, +/-10 V, 0 ~ +20 mA, +4 ~ +20 mA)
I-87028CW	8-ch. 12-bit current output module
I-87H17W	8-ch. analog input module and HART master module.

I-87K Multifunction I/O Modules

I-87026PW	6-ch. Analog Input, 2-ch. Analog Output, 2-ch. Digital Input and 2-ch. Digital Output Module (RoHS)
-----------	---

I-87K Digital I/O Modules

I-87037W	16-ch. source type Isolated Digital Output Module(RoHS)
I-87040W	32-ch. Isolated Digital Input Module
I-87040PW	32-ch. Isolated Digital Input Module with 16-bit Counters (RoHS)
I-87041W	32-ch. Sink Type Open Collector Isolated Digital Output Module
I-87046W	16-ch. Non-Isolated Digital Input Module for Long Distance Measurement
I-87051W	16-ch. Non-Isolated Digital Input Module
I-87052W	8-ch. Differential , Isolated Digital Input Module
I-87053PW	16-ch. Isolated Digital Input Module with 16-bit Counters
I-87053W	16-ch. Isolated Digital Input Module
I-87053W-A5	16-ch. 68 ~ 150 V _{DC} Isolated Digital Input Module
I-87053W-AC1	16-ch. AC Isolated Digital Input Module with 16-bit Counters
I-87053W-E5	16-channel 68-150 V _{DC} solated Digital Input Module with 16-bit Counters
I-87054W	Isolated 8-ch. DI and 8-ch. Open Collector DO Module
I-87055W	Non-Isolated 8-ch. DI and 8-ch. Open Collector DO Module

I-87057W	16-ch. Open Collector Isolated Digital Output Module
I-87057PW	16-ch. Open Collector Isolated Digital Output Module
I-87058W	8-ch. 80~250 V _{AC} Isolated Digital Input Module
I-87059W	8-ch. Differential 10-80 VAC Isolated Digital Input Module
I-87061W	16-ch. Relay Output Module (RoHS)
I-87063W	4-ch. Differential Isolated Digital Input and 4-ch. Relay Output Module 5 A (NO) / 3 A(NC) @ 5 ~ 24 V _{DC} ; 5 A(NO) / 3 A(NC) @ 0 ~ 250 V _{AC}
I-87064W	8-ch. Relay Output Module, 5 A (47~63 Hz) @ 0~ 250 V _{AC} ; 5 A @ 0~ 30 V _{DC}
I-87065W	8-ch. AC SSR Output Module, AC: 1.0 A _{rms} @ 24 ~ 265 V _{rms}
I-87066W	8-ch. DC SSR Output Module , DC: 1.0 A _{rms} @ 3 ~ 30 V _{DC}
I-87068W	4-ch. Form-A Relay Output and 4-ch. Form-C Relay Output Module ; Form-A: 8 A @ 250 V _{AC} ; 8 A @ 28 V _{DC} ; Form-C: 5 A (NO) / 3 A (NC) @ 277 V _{AC} ; 5 A(NO) / 3 A(NC) @ 30 V _{AC}
I-87069W	8-ch. PhotoMOS Relay Output Module, Max. AC/DC: 0.13 A @ 350 V
I-87K Counter/Frequency Modules	
I-87082W	2-ch. Counter/Frequency Module, Isolated or Non-isolated Inputs
I-87K PWMS Modules	
I-87088W	8-ch. PWM outputs, software support 1 Hz~100 kHz, (non-continuous), duty: 0.1 ~ 99.9%
I-87K GPS Modules	
I-87211W	Time-Synchronization and GPS module for getting UTC/local time and local Longitude/Latitude

RS-485 Remote I/O Modules	
I-7000 DCON Protocol	www.icpdas.com > product > solutions > remote i/o modules/units > I-7000 & M-7000
M-7000 Modbus RTU and DCON Protocol	www.icpdas.com > product > solutions > remote i/o modules/units > I-7000 & M-7000
tM-7000 DCON, Modbus RTU, Modbus ASCII Protocol	www.icpdas.com > product > solutions > remote i/o modules/units > tm-series
RS-485 Remote I/O Expansion Unit	
RU-87P1/2/4/8 Hot-Swap, Auto-Config.	www.icpdas.com > product > solutions > pac > I/O Expansion Unit
I-87K1/4/5/8/9	www.icpdas.com > product > solutions > pac > I/O Expansion Unit

Ethernet I/O Modules	
ET-7000 Web based	www.icpdas.com > product > solutions > Remote I/O > Ethernet I/O
PET-7000 PoE Web based	www.icpdas.com > product > solutions > Remote I/O > Ethernet I/O
tPET/tET-7000 Modbus TCP based (PoE)	http://www.icpdas.com/products/Remote_IO/petI-7000/PETL_Series_Main_Page.htm
Ethernet I/O Expansion Unit	
I-8KE4/8-MTCP Modbus/TCP based	www.icpdas.com > product > solutions > pac > iPAC-8000 > I-8KE4-MTCP-G/I-8KE8-MTCP-G

Specifications: VP-25W7 / VP-23W7 / VP-4137

Specification:

Models	VP-23W7	VP-25W7	VP-4137
System Software			
OS	Windows CE 5.0		
.Net Compact Framework	3.5		
Embedded Service	FTP server, Web server (supports VB script, JAVA script), Embedded SQL server		
SDK Provided	Dll for eVC, Dll for Visual Studio.Net 2005/2008		
Multilanguage Support	English, German, French, Spanish, Russian, Italian, Korean, Simplified Chinese, Traditional Chinese		
Development Software			
ISaGRAF Software	ISaGRAF Ver.3	IEC 61131-3 standard	
	Languages	LD, ST, FBD, SFC, IL & FC; Support Soft-GRAF HMI: XP-8xx7-CE6/8xx7-Atom-CE6, WP-8xx7/5xx7 and VP-2xW7/4xx7 PAC	
	Max. Code Size	1 MB	
	Scan Time	3 ~ 15 ms for normal program 15 ~ 50 ms (or more)for complex or large program	
Non-ISaGRAF	Options: MS eVC++ 4.0 or VS .NET 2005/2008 (VB.NET, C# .NET)		
Web Service			
Web HMI	PC running Internet Explorer can monitor/control PAC via Internet/modem		
Security	Support three-level username and password protection. (high/middle/low)		
CPU Module			
CPU	PXA270, 520 MHz		
SDRAM	128 MB		
Flash	96 MB		128 MB
Expansion Flash Memory	microSD socket with one microSD card (support up to 32 GB)		
Dual Battery Backup SRAM	512 KB; data valid up to 5 years (for retain variables)		
EEPROM	16 KB		
RTC (Real Time Clock)	Provide second, minute, hour, date, day of week, month, year		
64-bit Hardware Serial Number	Yes, for Software Copy Protection		
Dual Watchdog Timers	Yes (0.8 second)		
Rotary Switch	Yes (0 ~ 9)		
Communication Interface			
Ethernet	RJ-45 x 1		
	10/100 Base-TX (Auto-negotiating, LED indicators)		
USB 1.1 (host)	1		2
USB 1.1 (client)	-		1
COM 0	Internal communication with the high profile I-87K series modules in slots		
COM 1	-		

COM 2	RS-485 (Data+, Data-) with internal self-tuner ASIC; 2500 VDC isolated		
COM 3	RS-232 (RxD, TxD, CTS, RTS, DSR, DTR, CD, RI and GND); Non-isolated		
MMI (Man Machine Interface)			
LCD	3.5" TFT (Resolution 320 x 240)	5.7" TFT (Resolution 640 x 480)	10.4" TFT (Resolution 800 x 600)
Touch Panel	-	Yes	
Rubber Keypad	24 keys	6 Keys	-
Audio	Microphone-In and Earphone-Out		Earphone-Out
LED Indicators	3 Dual-Color LEDs (PWR, RUN, LAN1, L1, L2, L3; L1 ~ L3 for User Programmable)		2 LEDs (PWR, RUN)
I/O Expansion Slots			
Slot Number	3		
	Note: For High Profile I-8K and I-87K Modules Only		
Mechanical			
Dimensions (W x L x H)	182 mm x 158 mm x 125 mm		293 mm x 231 mm x 129 mm
Installation	Panel Mounting		
Ingress Protection	Front panel: IP65		
Environmental			
Operating Temperature	-20 ~ +70°C		
Storage Temperature	-30 ~ +80°C		
Ambient Relative Humidity	10 ~ 90% RH (non-condensing)		
Power			
Input Range	+10 ~ +30 VDC		
Isolation	1 kV		
Capacity	12.5 W		
Consumption	7.2 W		8.5 W
Protocols (Note that certain protocols require optional devices)			
NET ID	1 ~ 255, user-assigned by software		
Modbus TCP/IP Master	Link to a max. of 100 devices that support the Standard Modbus TCP/IP Slave protocol (FAQ-113)		
Modbus RTU/ASCII Master	A max. of 10 ports: COM2, 3 and COM5 ~ 14. (To connect to other Modbus Slave devices.) Support Multi-port. (*)		
Modbus RTU Slave	A max. of 5 ports: one of COM2/3, COM5 ~ 8. (For connecting ISaGRAF, PC/HMI/OPC Server and HMI panels.) (*)		
Modbus TCP/IP Slave	LAN1 and optional 2nd Ethernet Port in I-8135W support total up to 32 connections for connecting ISaGRAF and PC/HMI. If one of the Ethernet port malfunctions, the other one can still be used to connect to the PC/HMI.		
Web HMI Protocol	Ethernet ports for connecting a PC running Internet Explorer.		
User-defined Protocol	Custom protocols can be applied at COM2~3 and COM5~14 using Serial communication function blocks. (*)		
I-7000 & I-87K RS-485 Remote I/O	One of COM2 or COM3 supports I-7000 I/O modules, I-87K base + I-87K Serial I/O boards, or RU-87Pn + I-87K High Profile I/O boards as remote I/O. A max. of 255 I-7000/87K remote I/O modules can connect to one PAC. (*)		

M-7000 Series Modbus I/O	A max. of 10 RS-485 ports: COM2, 3, 5 ~ 14. Each port can connect to up to 32 M-7000 modules. (With optional I-7510 repeater connected can connect to up to more than 32 M-7000 Modules) (*)
Modbus TCP/IP I/O	Supports ICP DAS Ethernet I/O : I-8KE4-MTCP and I-8KE8-MTCP. If LAN1 malfunctions, it will automatically switch to the 2nd Ethernet port (in optional I-8135W card) to continuously work. (The IP address for LAN1 and the 2nd Ethernet's IP should be set in the same IP domain) (FAQ-042)
FRnet I/O	Enable a max. of 3 pcs. I-8172W boards in slot 0~2 to be used to connect to FRnet I/O modules, such as FR-2053, FR-2057, FR-32R, FR-32P. Each I-8172W board can link to a max. of 256 DI plus 256 DO channels. (FAQ-082, 154)
Send Email	Provide functions to send email with a single attached file via the Ethernet port.
Ebus	Used to exchange data between ICP DAS ISaGRAF Ethernet PACs via the Ethernet port. (LAN1 Port only)
SMS: Short Message Service	Either COM3 or COM5 can link to a GSM Modem to support SMS. The user can request data/control the controller via a cellular phone. The controller can also send data and alarms to the user's cellular phone. Optional GSM Modem: GTM-201-RS232 (850/900/1800/1900 GSM/GPRS External Modem)
MMICON/LCD	COM3 or COM5 supports the ICP DAS MMICON. (*) The MMICON is featured with a 240 x 64 dot LCD & a 4 x 4 Keyboard to display picture, string, integer, float, & input a char, string, integer & float.
UDP Server & UDP Client : Exchange Message & Auto-report	LAN1 or the 2nd Ethernet (in optional I-8135W card) supports the UDP Server and UDP Client protocols allowing messages to be sent/received to/from a PC/HMI or other device. For example, data can be automatically reported to the InduSoft's RXTX driver.
TCP Client : Exchange Message & Auto-report	LAN1 or the 2nd Ethernet (in optional I-8135W card) supports the TCP Client protocol allowing messages to be sent/received to/from a PC/HMI or other device that supports the TCP server protocol. For example, data can be automatically reported to the InduSoft's RXTX driver, or to connect a location camera.
GPRS/SMS	Enable the I-8212W (2G/3G) card allowing short messages to be sent/received to/from or to access a dial up connection to link to the Internet and using a GPRS connection to send an email or communicate with remote stations using the "FTP Client" (FAQ-151) or the "TCP Client"/"UDP Server"/"UDP Client" (FAQ-143) protocols.
SQL Client	Support for the SQL Client function that allows data to be written (or read from) a Microsoft SQL Server (2000 SP3, 2005, 2008).
Hot-Swap and Redundant System	Must enable the 2nd Ethernet port in the optional I-8135W card. This redundant system has setup two "Active IP" address point to the active VP-2xW7/2xW6 's LAN1 and 2nd Ethernet ports always. One or two or more PC / HMI / SCADA can communicate with this redundant system via one of the two given active IP. So the PC / HMI / SCADA can access to the system easily without any notice about which VP-2xW7/2xW6 is currently active. Moreover, the new redundant system can integrate with the RU-87P4 and RU-87P8 expansion unit plus the I-87K high-profile I/O cards to support the hot-swap application. If the I/O card is damaged, the maintenance person just takes one good-card with same model number to hot-swap the damaged one without stopping this redundant system. (FAQ-093)
CAN/CANopen	COM3 or COM5~14 can connect to one I-7530 (converter: RS-232 to CAN) to support CAN/CANopen devices and sensors. One PAC supports a max. of 10 RS-232 ports to connect a max. of 10 I-7530. (*) (FAQ-086)
CANopen Master	Enable the I-8123W CANopen Master card to connect to other CANopen Slave devices. (FAQ-145)
HART Solutions	Enable I-87H17W modules in slots 0 to 2 to communicate with other HART devices.
FTP Client	Enable the FTP Client to upload files from the PAC to a remote FTP server on a PC. (FAQ-151) The Soft-GRAF g_Alarm and g_Logger1 HMI objects also support FTP Client. (FAQ-146)

Soft-GRAF HMI		Provide support for the Soft-GRAF HMI. The user can design the HMI screen using the Soft-GRAF Studio on the PC and then download it to the PAC to display the HMI on the PAC. (FAQ-146)
Optional I/O Functions (Refer to the ISaGRAF PAC I/O Selection Guide for I/O Module list)		
PWM Output	High Speed PWM Module	I-7088, I-8088W, I-87088W: 8-ch. PWM outputs, software support 1 Hz~100 kHz (non-continuous), duty: 0.1~99.9%
	DO Module as PWM	8-ch. max. 250 Hz max. For Off=2 & On=2 ms. Output square curve: Off: 2 ~ 32766 ms, On: 2 ~ 32766 ms. Optional DO Boards: I-8037W, 8041W, 8041AW, 8042W, 8050W, 8054W, 8055W, 8056W, 8057W, 8060W, 8063W, 8064W, 8068W, 8069W. (Relay Output boards cannot generate fast square wave)
Encoder, FrequencyCounter,	Parallel DI Counter	8-ch. max. For 1 controller. Counter val: 32-bit. 250 Hz max. Min. ON & OFF width must > 2 ms. Optional DI boards: I-8040W, 8040PW, 8042W, 8046W, 8048W, 8050W, 8051W, 8052W, 8053W, 8053PW, 8054W, 8055W, 8058W, 8063W.
	Serial DI Counter	Counter input: 100 Hz max. Counter value: 0 ~ 65535 (16-bit) Optional serial I-87K DI boards: I-87040W, 87046W, 87051W, 87052W, 87053W, 87053W-A5, 87054W, 87055W, 87058W, 87059W, 87063W.
	Remote DI Counter	All remote I-7K/I-87K DI modules support counters. 100 Hz max. Value: 0 ~ 65535
	High Speed Counter	I-87082W: 100 kHz max., 32-bit; I-8084W: 250 kHz max., 32-bit
	Encoder	I-8093W: 3-axis Encoder Module, max. 1M Hz for quadrant input mode, max. 4 MHz for pulse/direction and cw/ccw input mode. (FAQ-112) I-8084W: 250 kHz max., 4-ch encoder, pulse/direction or up/down or A/B phase (Quad. mode), Not support Encoder Z-index. (FAQ-100)
	Frequency	I-87082W: 2-ch, 1 Hz ~ 100 kHz; I-87088W: 8-ch, 0.1 Hz ~ 500 kHz; I-8084W: 8-ch, 1 Hz ~ 250 kHz;
Motion	Motion Control	one I-8091W (2-axis) or two I-8091W (4-axis) can do motion control. only one I-8091W can do X-Y dependent motion.
Port	Second Ethernet	VP-2xW7/2xW6/4137 can add one optional I-8135W card in its slot 0 ~ 2 to expand the second Ethernet port.
<p>* Note: The COM5 ~ COM14 ports are located in the expansion boards if they are installed in slots 0~2 of VP-2xW7/4xx7.</p> <p>* ISaGRAF FAQ: www.icpdas.com > Support > FAQ > ISaGRAF Soft-Logic PAC</p> <p>* ICP DAS recommends using NS-205/NS-208 or RS-405/408 (Ring Switch) Industrial Ethernet Switches.</p>		

Chapter 1 Typical Application

The website for the applications supporting list of all ISaGRAF PACs : www.icpdas.com > [Product > Solutions > Soft PLC, ISaGRAF & Soft-GRAF HMI > ISaGRAF > Applications](#)

1.1 Soft-GRAF HMI Application: Colorful HMI

- Support Various and Colorful HMI Objects:
 - Pages (Max. 200, Support Password Security)
 - Label (Normal, Reverse Type, Under-line)
 - Boolean Value (Normal, Reverse Type, Blinking)
 - Numeric Value (Normal, Scaling, Limit - Blink/Color/Text)
 - Message Value (Dynamic Message, Multi-language)
 - Button (Value, Title, Picture, Security, Confirm, Password)
 - Picture (Static, Dynamic, Boolean Picture)
 - Login/Logout
 - Bar Meter (Vertical, Horizontal, Scale, Unipolar, Bipolar)
 - Trace (1-axis, 2-axis)
 - Trend (Real-time, Historical)
 - Schedule-Control
 - Gauge Meter
 - Alarm Lists
 - Data Logger (Log data; support USB export or FTP upload)
 - Built-in Various Objects (Button, Gif, LED... will be More)
- Multi-language: English, Traditional Chinese, Simplify Chinese, Russian, etc.
- Support user designed graphics, e.g. JPG, PNG ...
- More at: [Chapter 2.5](#) & FAQ www.icpdas.com > [Support > FAQ > ISaGRAF Soft-Logic PAC – FAQ-146](#)



1.2 eLogger HMI Application

- ICP DAS eLogger is an easy and useful HMI development tool which helps user to create user-friendly pictures and control items. (Recommend to use Soft-GRAF HMI, the performance is better. Please refer to [Section 2.5.](#))
- More at: www.icpdas.com > [Support](#) > [FAQ](#) > [ISaGRAF Soft-Logic PAC – FAQ-115](#)

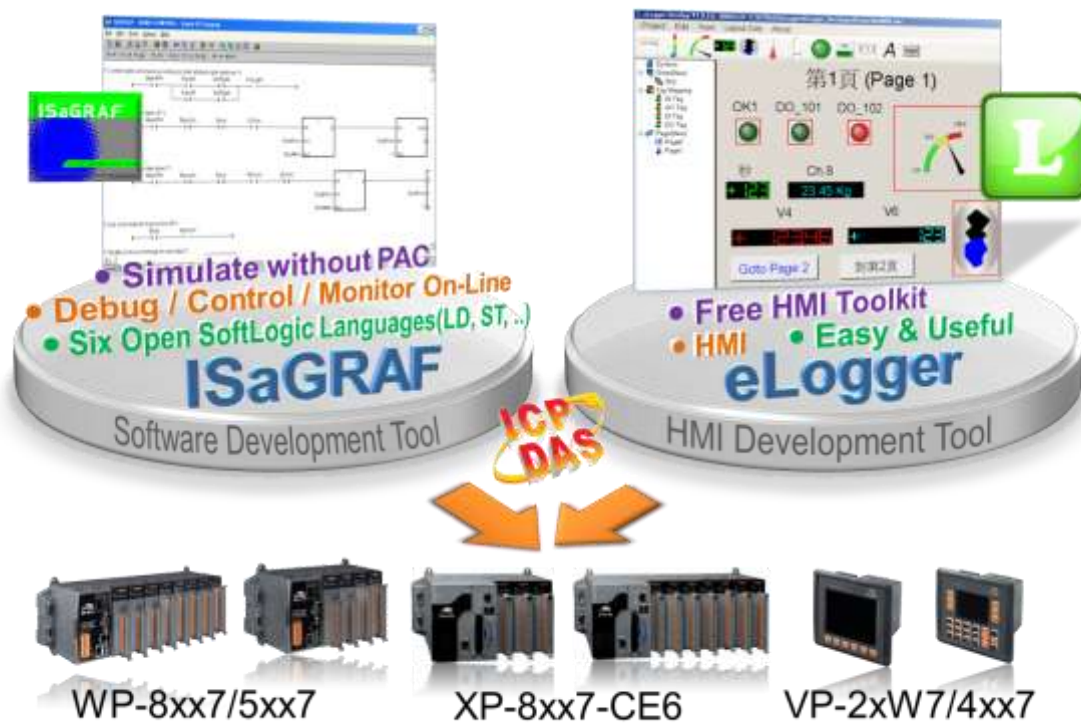

1.3 Redundant Communication System

- More at www.icpdas.com > [Support](#) > [FAQ](#) > [ISaGRAF Soft-Logic PAC - 119](#)
- RS-485 or Ethernet redundant communication mechanism/applications.
- For XP-8xx7-CE6, XP-8xx7-Atom-CE6, WP-8xx7 & VP-2xW7/4xx7 series.

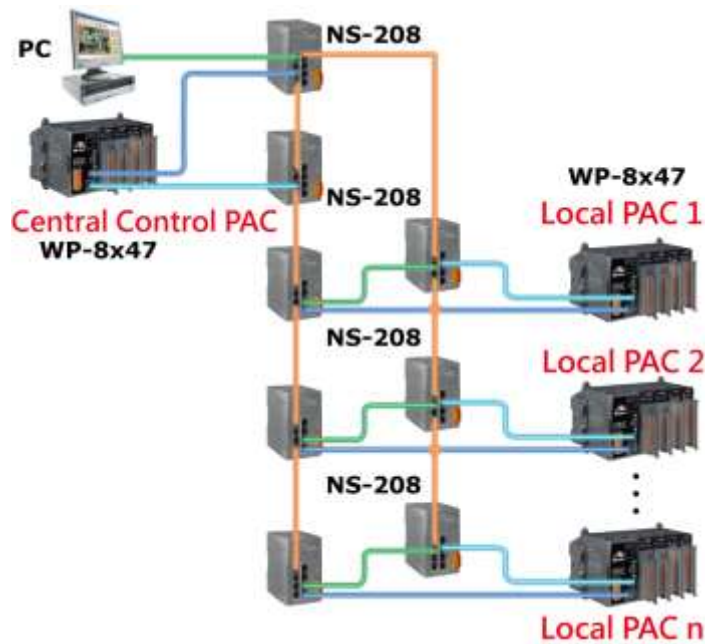

1.4 New Hot-Swap and Redundant System

- Please plug one I-8135W and enable the 2nd Ethernet port of VP-25W7/23W7/4137.
- If one Ethernet cable is broken or damaged, the other one will still work.
- If one controller is damage, the other one will take over the control of the RS-485 I/O.
- PC/HMI can connect to this redundant system by one or two active IP.
- More at www.icpdas.com > [Support](#) > [FAQ](#) > [ISaGRAF Soft-Logic PAC - 093](#)

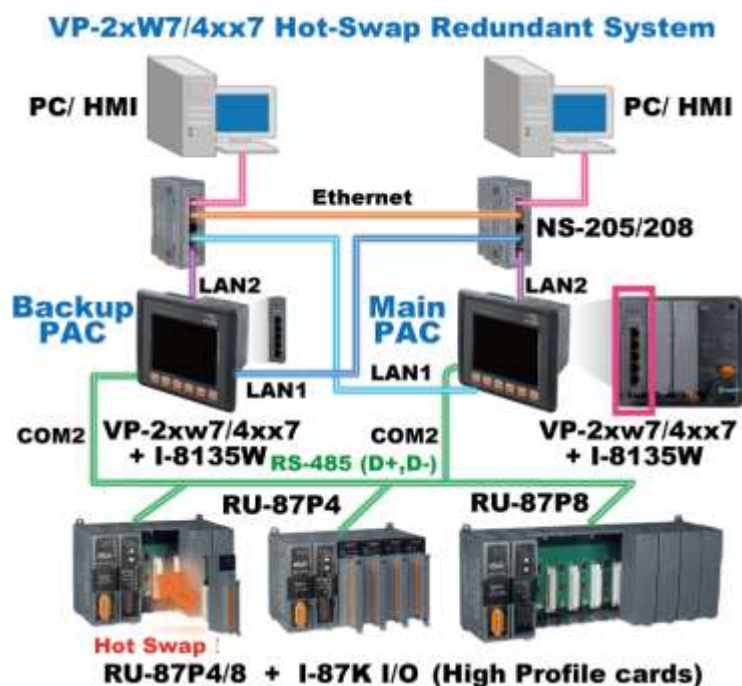

1.5 Modbus Master: RTU, ASCII, RS-232/485/422

- Support up to 10 ports: COM2~COM3 & COM5~COM14 (if I-8112iW/ 8114W/ 8114iW/ 8142iW/ 8144iW in Slot0 ~ 2)
- Can link to Modbus PLC or M-7000 I/O or Modbus devices (Power meter, temperature controller, inverter etc.)



1.6 Modbus Master: TCP/IP

- Each ISaGRAF WinCE ViewPAC supports to link to max. 100 Modbus TCP/IP slave devices.
- Support various Standard Modbus TCP/IP Slave devices.
- More at www.icpdas.com > [Support](#) > [FAQ](#) > [ISaGRAF Soft-Logic PAC](#) > [FAQ-113](#)

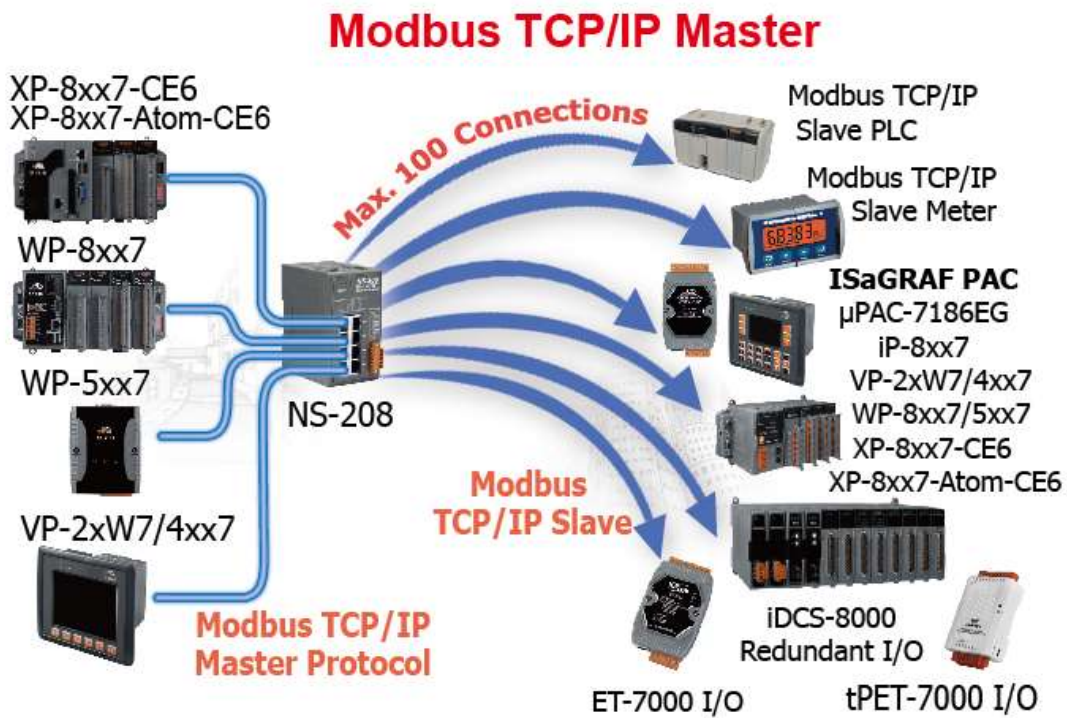

1.7 Modbus Slave: RTU/TCP

- Modbus RTU (RS-232/485/422): max. 5 ports
- Modbus TCP/IP: max. 32 connections

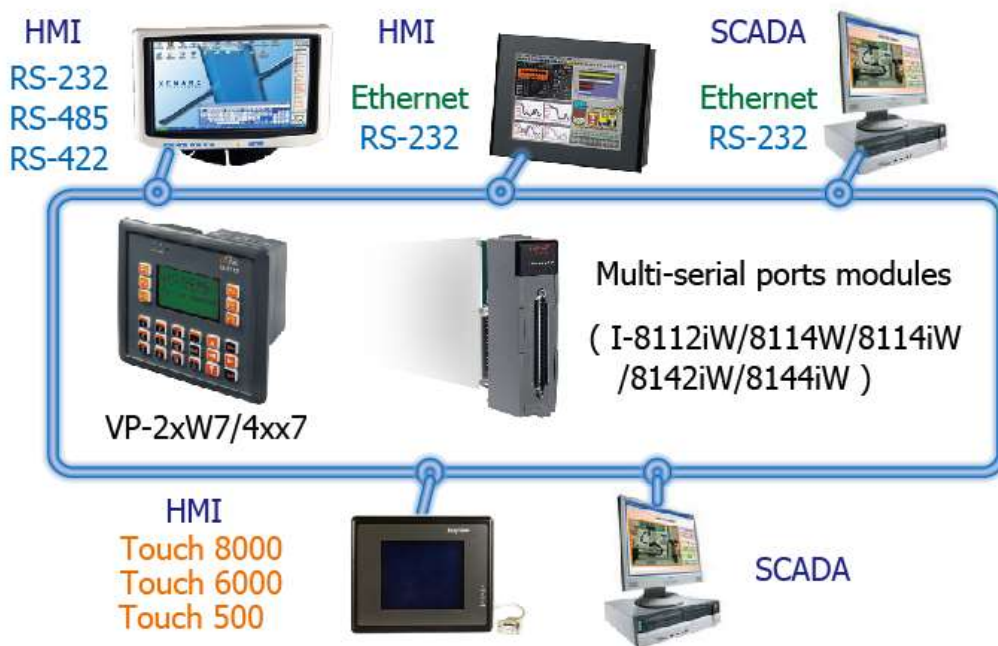

1.8 Communicate With Other TCP/IP Server or UDP Client/Server Devices



1.9 Multiple Web HMI – Monitor & Control Everywhere!

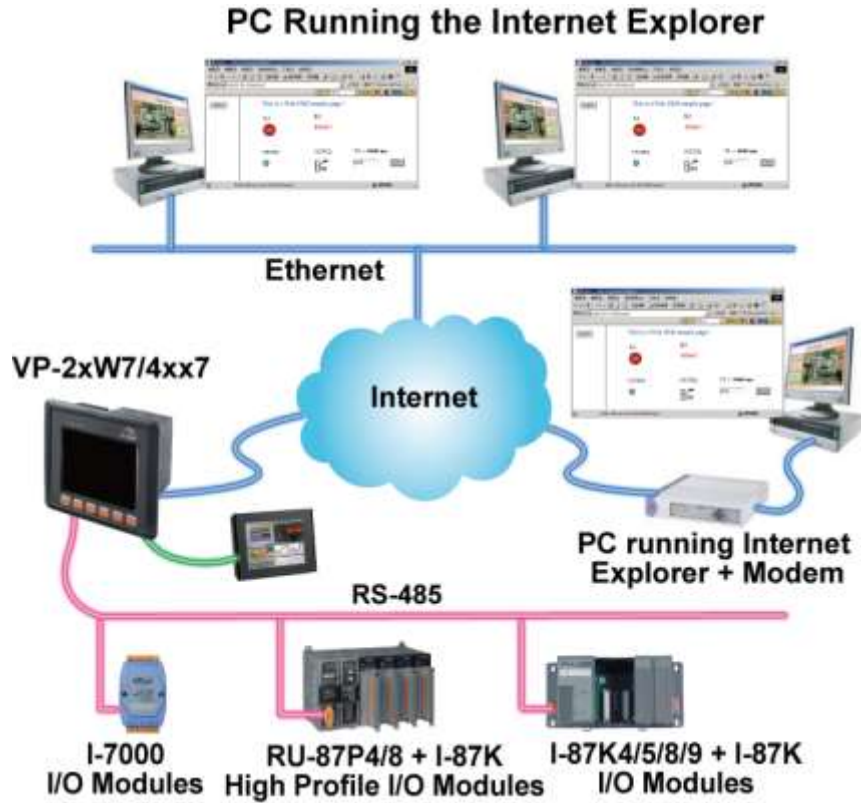

1.10 Send Email with One Attached File

- More at www.icpdas.com > [Support](#) > [FAQ](#) > [ISaGRAF Soft-Logic PAC - 067](#)

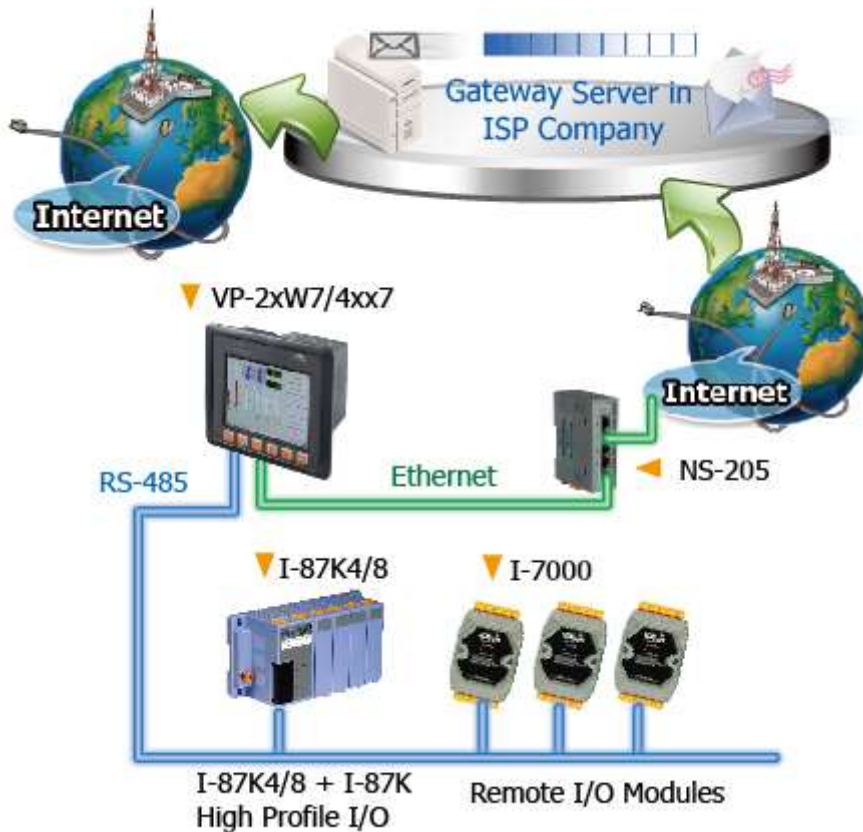

1.11 Data-Recorder & Data-Logger

- PC can load the data file stored in the VP-2xW7/4xx7's Flash Disk or micro-SD card by FTP or by Web HMI.

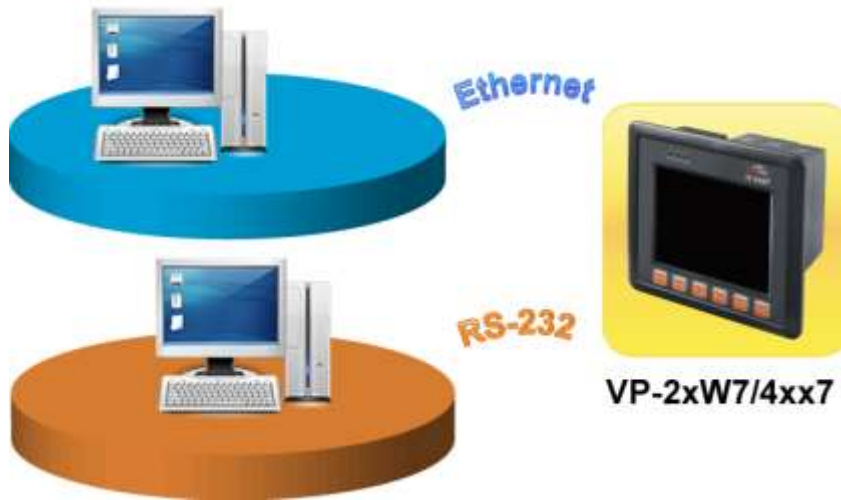

1.12 Remote I/O Application

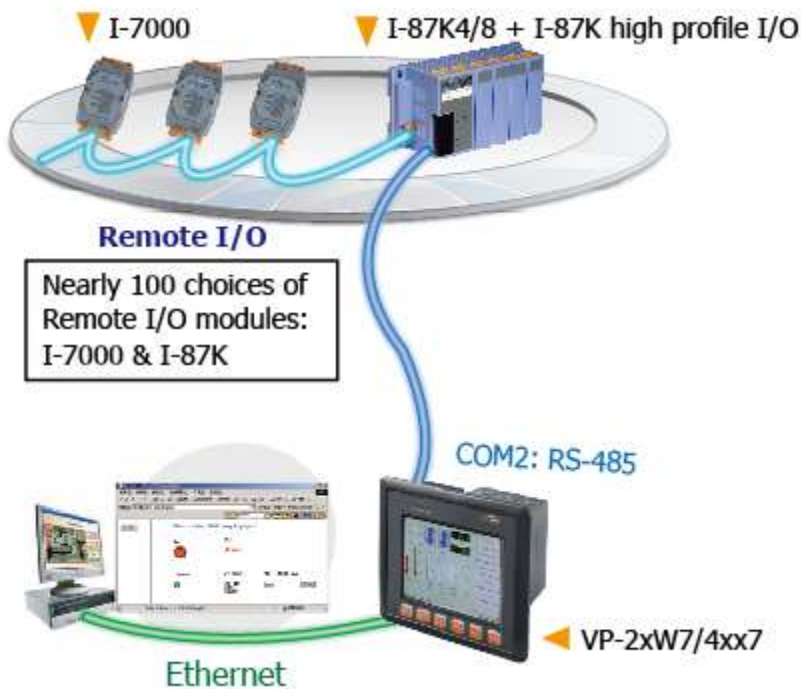

1.13 SMS: Short Message Service

- Short message can be sent in multiple language format (like Chinese, English... others) and pure text can be sent/received.
- More at www.icpdas.com > [Support](#) > [FAQ](#) > [ISaGRAF Soft-Logic PAC - 111](#)

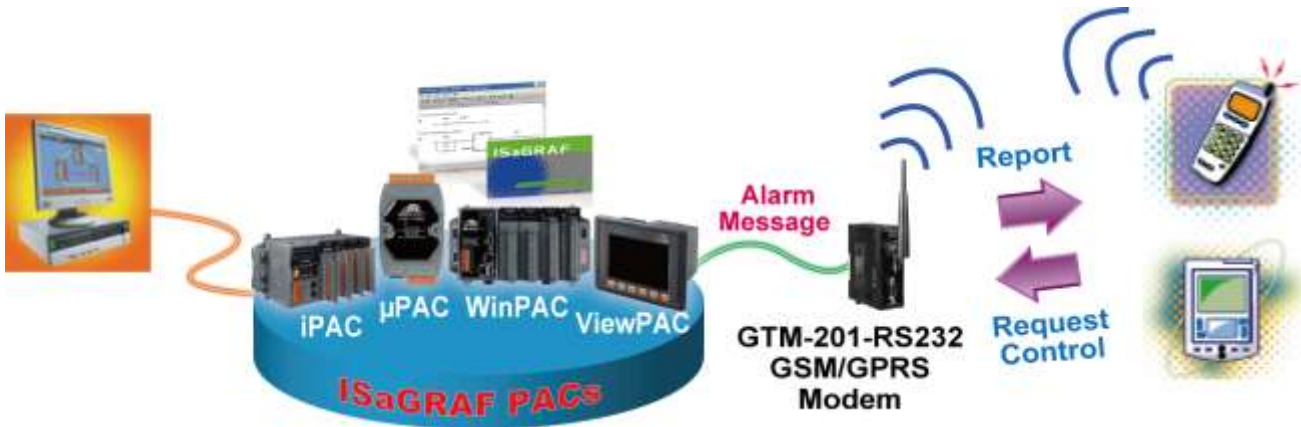

1.14 As a Modbus Gateway for the Remote I/O Modules

- The ISaGRAF PACs (with Ethernet port) :
can be a **Modbus RTU Serial & TCP/IP gateway** of I-7000 & I-87K Series I/O modules.
- The ISaGRAF PACs (without Ethernet port) :
can be a **Modbus RTU Serial gateway** of I-7000 & I-87K Series I/O modules.

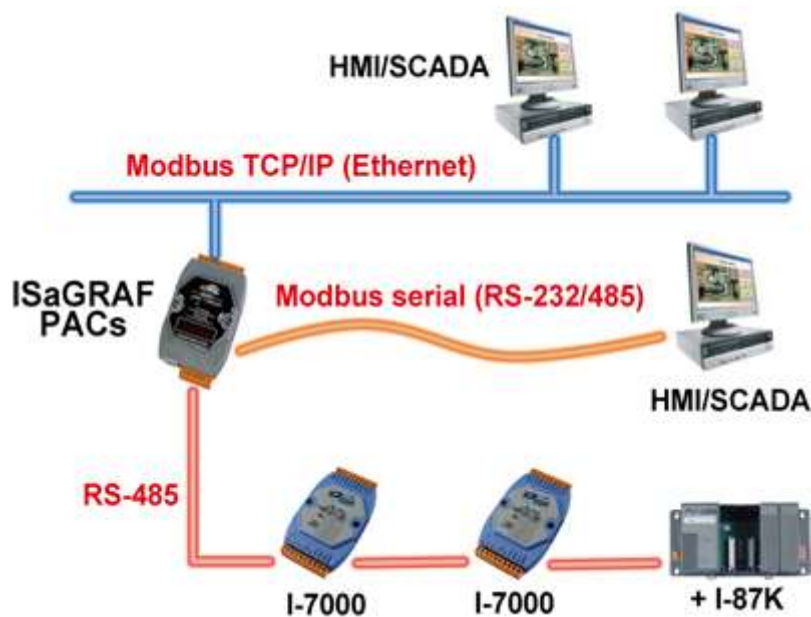

1.15 Motion Control

- One **I-8091W** can control 2 axes: X-Y plane, or 2 axes independent
- Two **I-8091W** can control 4 axes: X-Y plane + 2 axes independent, or 4 axes independent
- Encoder Modules:
I-8084W: 4-axis, without Z-index
I-8090W: 3-axis



1.16 Stress Monitoring Application of Constructions

- More at www.icpdas.com > [Support](#) > [FAQ](#) > [ISaGRAF Soft-Logic PAC - 091, 128](#)

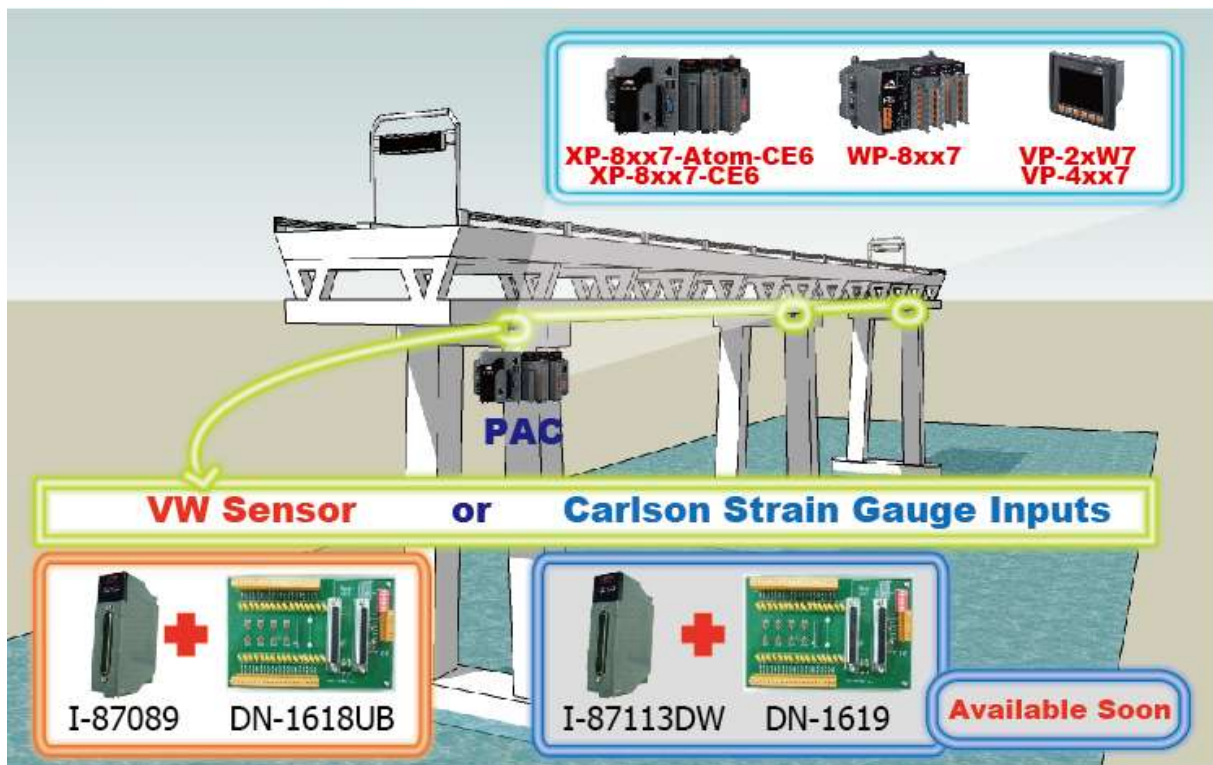

1.17 Fast FRnet Remote I/O

- **Advantage of FRnet I/O:** Fast I/O scan: About 3 ms/scan.
(It depends on your program's PLC scan time. Ex: If the ISaGRAF program's PLC scan time is about 9 ms, then the scan time for all will be 9 ms, not 3 ms)
- Support FRnet DI, DO, AI and AO I/O modules.
- More at www.icpdas.com > [Support](#) > [FAQ](#) > [ISaGRAF Soft-Logic PAC - 082, 154](#)

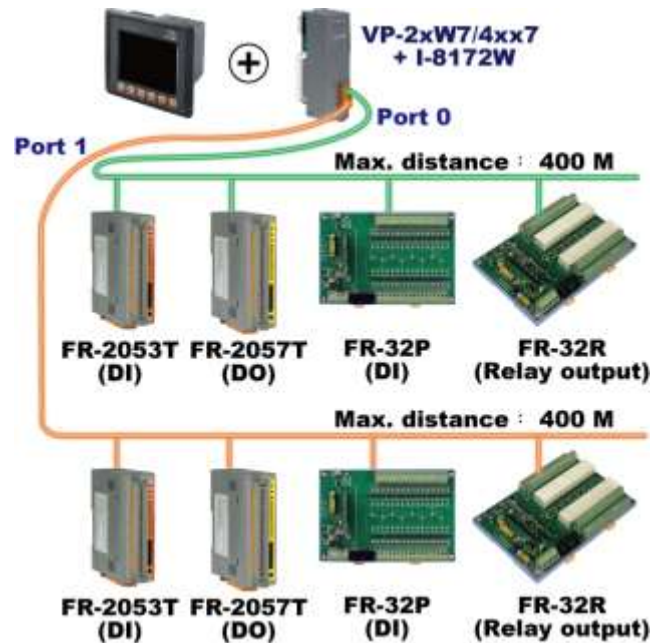

1.18 Integrate with CAN/CANopen Devices & Sensors

- ISaGRAF WinCE ViewPAC supports max. 10 I-7530 (RS-232 to CAN Converter)
- Support I-8123W CANopen master card, too. ([FAQ-145](#))
- More at www.icpdas.com > [Support](#) > [FAQ](#) > [ISaGRAF Soft-Logic PAC > 086, 145](#)

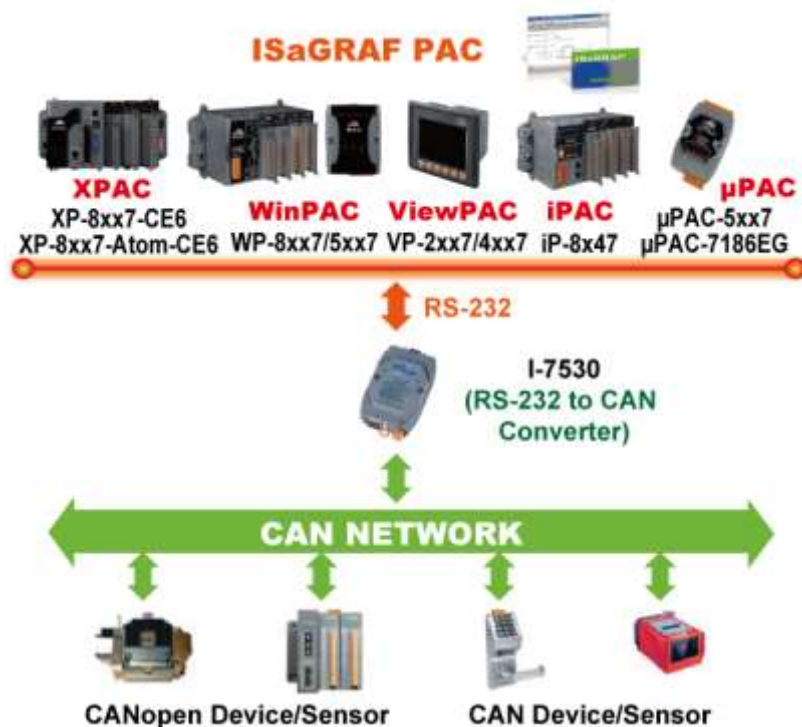

1.19 VIP Communication Security

- Set VIP (Very Important IP No.) for Modbus TCP/IP security.

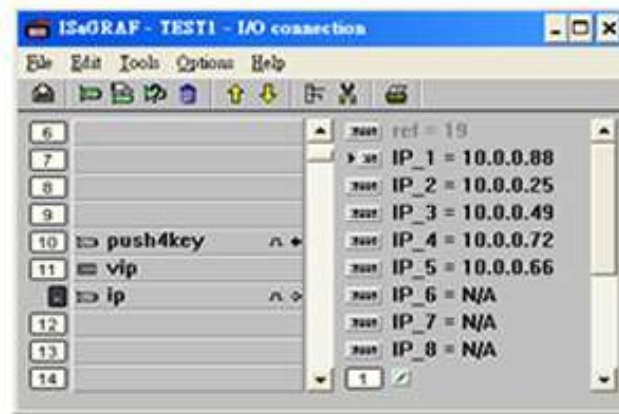

1.20 ISaGRAF PAC Connects the Smart Power Meter

- Support standard Modbus protocol, support multiple RS-485 ports to connect to multiple PM-2133/2134 Smart meters
- PM-2133/2134 is a series of 3 Phase/4 Loops 1 Phase Compact Smart Meter with true RMS energy and power parameters measurement in compact size. The ISaGRAF PACs combining with PM-213x can apply to various control/monitor systems about intelligent electric power measurement.
- More at www.icpdas.com > [Support](#) > [FAQ](#) > [ISaGRAF Soft-Logic PAC > 129](#)

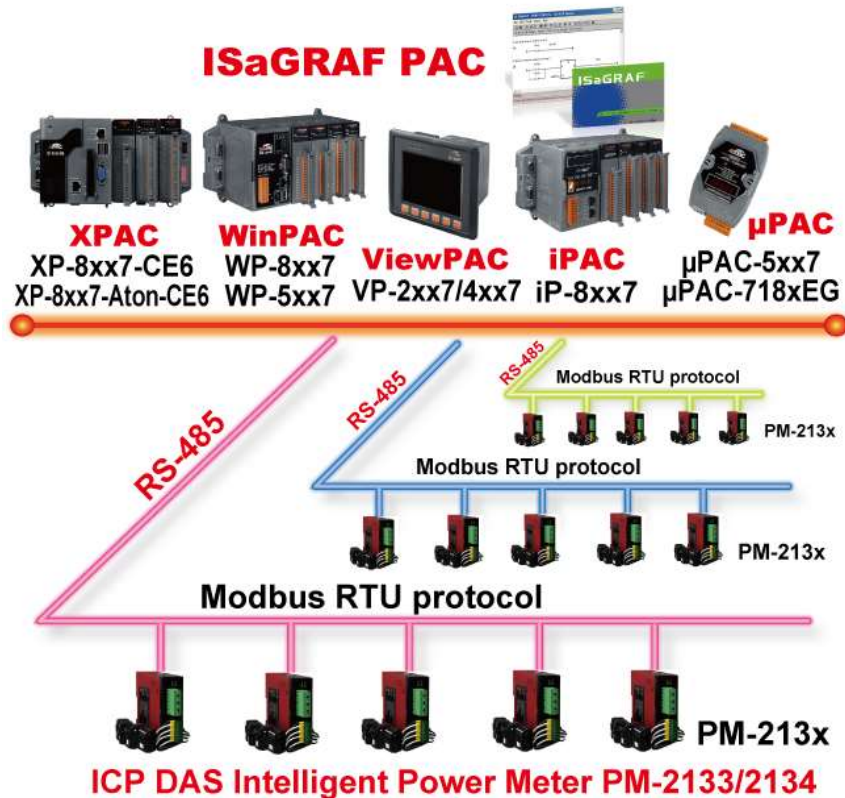

1.21 ZigBee Wireless Solution

The ISaGRAF PAC plus ZB-2550P and ZB-2551P RS-232/RS-485 Converters can apply wireless communication, reduce the wiring cost, and achieve the mission of remote I/O control and data acquisition.

Please refer to www.icpdas.com > Support > FAQ > ISaGRAF Soft-Logic PAC > 110

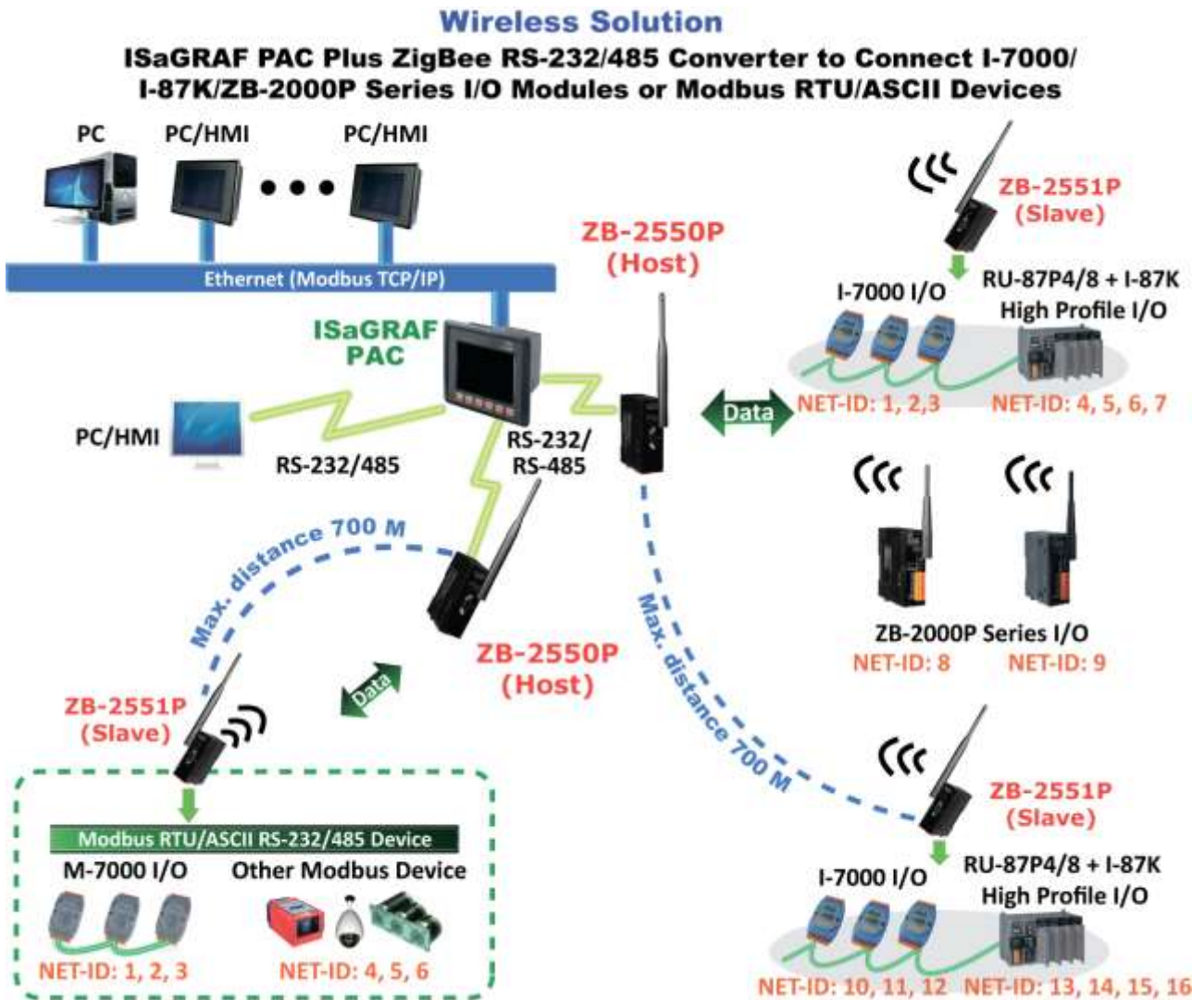

1.22 GPS Application: ISaGRAF PAC Plus I-87211W or GPS-721

- ISaGRAF PAC can support one I-87211W (slot 0~7) or I-87211W / GPS-721 as RS-485 remote GPS I/O.
- For doing auto-time-synchronization and getting local Longitude and Latitude
- More at www.icpdas.com > [Support](#) > [FAQ](#) > [ISaGRAF Soft-Logic PAC](#) > [FAQ-107](#)
- More GPS receivers at www.icpdas.com > [Products](#) > [Wireless.....](#) > [GPS receiver](#)



1.23 Data Exchange: Ebus

- **Ebus (Ethernet Network)**

Each ISaGRAF PAC can use its Ethernet port to talk to each other via the Ebus communication mechanism. When PC is talking with controllers via Ethernet, the controllers can also talk to each other via the same Ethernet; It makes the configuration more flexible and faster.

- **Note: The XP-8xx7-CE6, XP-8xx7-Atom-CE6, WP-8xx7 and VP-2xW7/4xx7 don't support Fbus.**

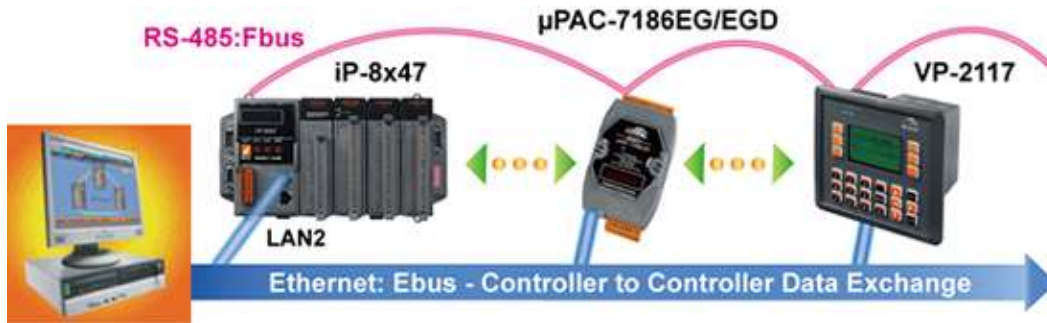

1.24 Detect Hot-Swap I-87K (High Profile) I/O Status

- In ISaGRAF Workbench, you must connect the I/O board to the "I/O connection" windows correctly and select the "io_state" board then you can observe the I/O status. When you Hot-Swap the I-87K (High Profile) I/O, the message will show on the front panel of ISaGRAF PAC.

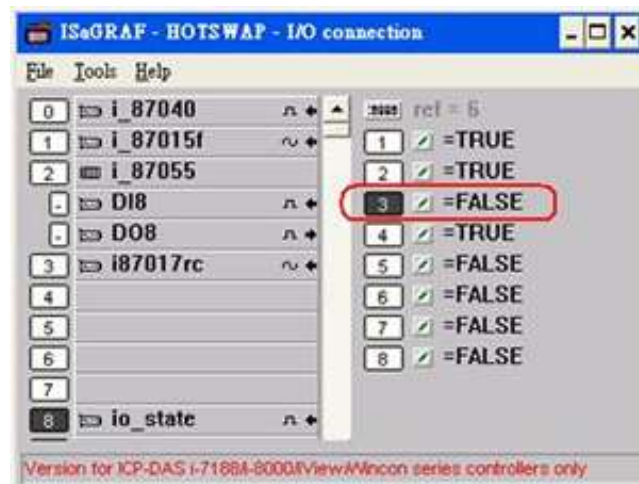

1.25 Database Application

- Supports SQL Client functions to write data to (or read data from) Microsoft SQL Servers (2000 SP3, 2005, 2008).
- One PAC can connect max. 4 Servers.
- The PAC supports Multi-Language (depends on the model number), include Traditional Chinese (Taiwan), Simplified Chinese, English, French, German, Italian, Portuguese, Russian, Spanish and others.
- Integrating Machine-Business Automation Application.
- More at www.icpdas.com > [Support](#) > [FAQ](#) > [ISaGRAF Soft-Logic PAC > 135](#)

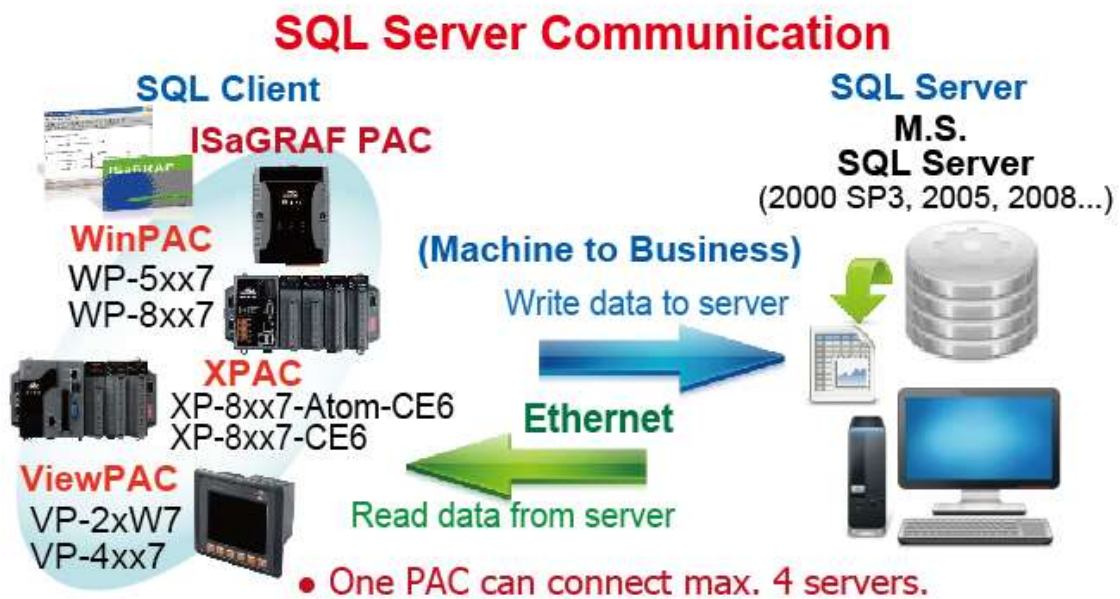

1.26 HART Solutions

- ISaGRAF PAC support I-87H17W modules to communicate with other HART Devices.(Driver version- XP-8xx7-CE6: 1.15 ; XP-8xx7-Atom-CE6: 1.01 ; WP-8xx7: 1.35 ; VP-2xW7/4xx7: 1.27)
- ISaGRAF PAC support I-87H17W modules in its main control unit only (XP-8xx7-CE6/XP-8xx7-Atom-CE6: slot 1 ~ 7 ; WP-8xx7: slot 0 ~ 7 ; VP-2xW7/4xx7: slot 0 ~ 2). They don't support I-87H17W modules plugged in the RS-485 remote I/O expansion unit.
- I-87H17W provides eight Analog Input channels to measure 4 to 20 mA current input. It also can be used as 8-ch HART communication ports.
- More at www.icpdas.com > [Support](#) > [FAQ](#) > [ISaGRAF Soft-Logic PAC > 136](#)

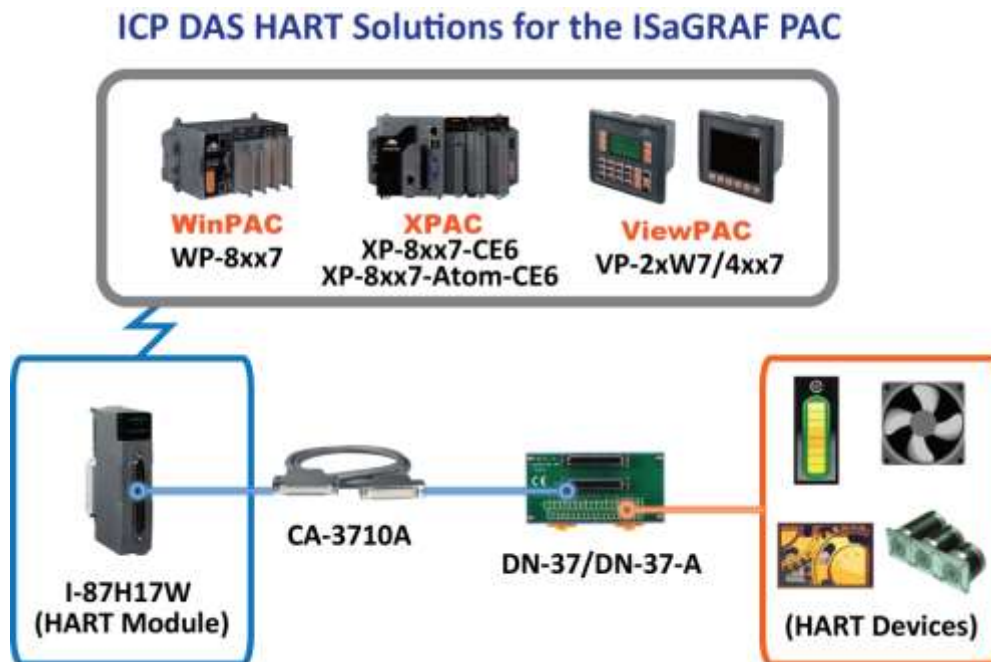

1.27 2G/3G Wireless Application

- Support to communicate with remote Server by 2G/3G wireless modem.
- More at www.icpdas.com > [Support](#) > [FAQ](#) > [ISaGRAF Soft-Logic PAC](#) - [143](#), [151](#), [153](#) .

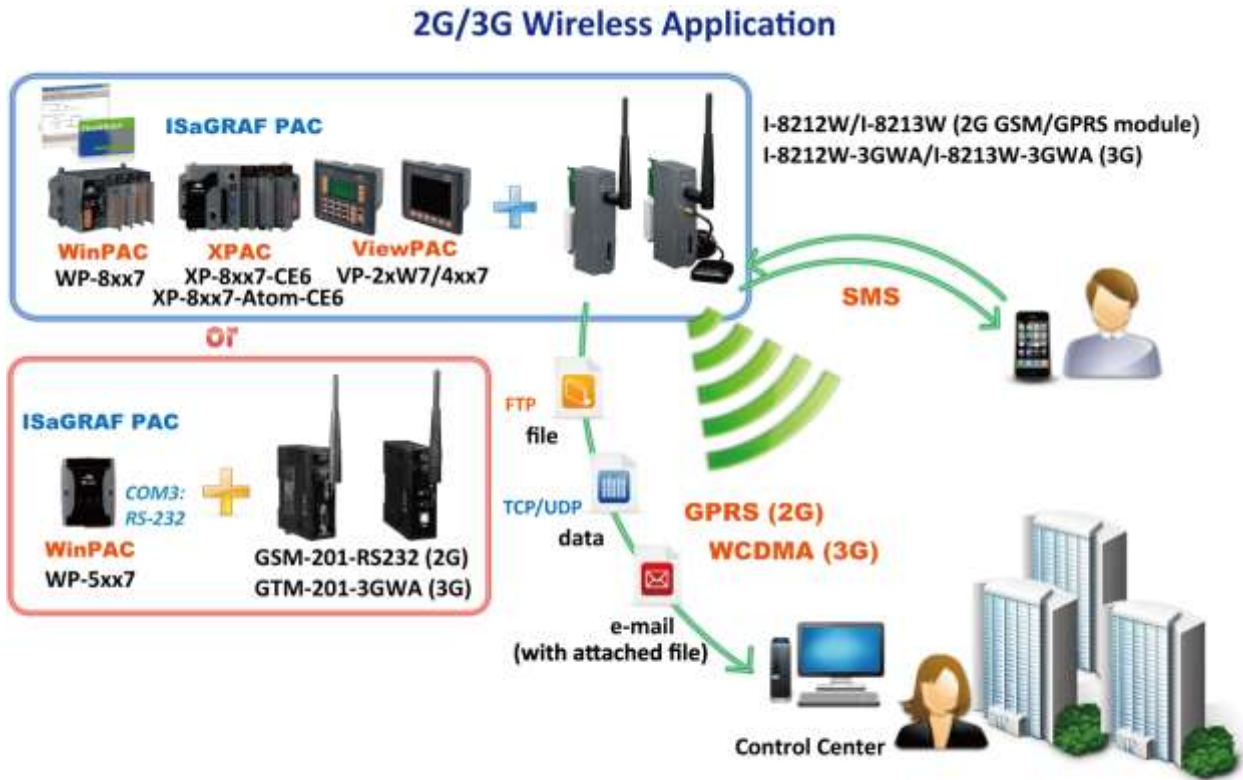

1.28 Measure humidity and temperature values via DL-100TM485

- More at www.icpdas.com > [Support](#) > [FAQ](#) > [ISaGRAF Soft-Logic PAC](#) - [156](#)

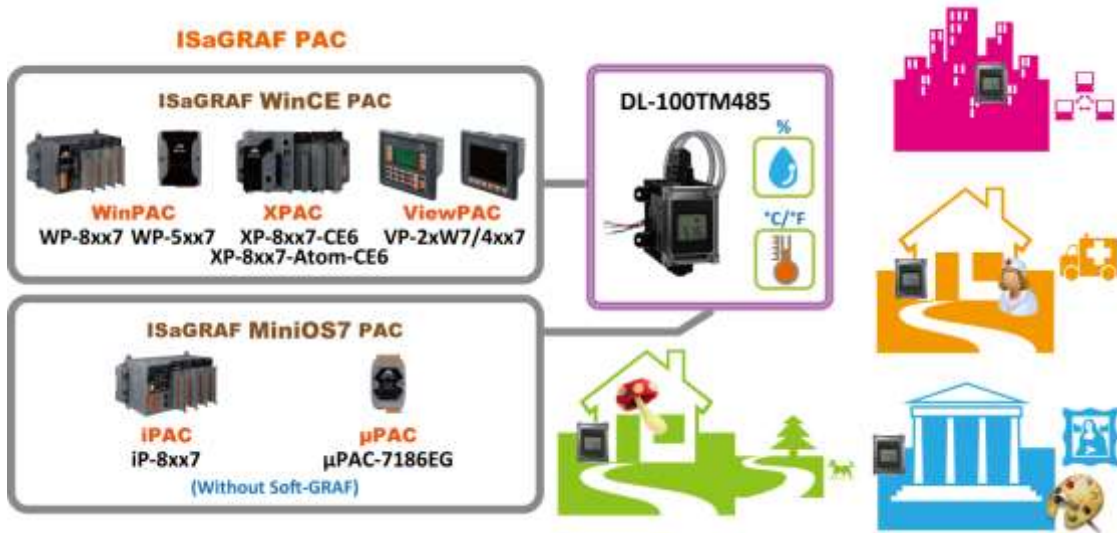

Chapter 2 Software Installation And Working Soft-GRAF HMI with ISaGRAF

Refer to [Section 2.5](#) for programming the Soft-GRAF HMI applications with ISaGRAF.

Refer to [Section 2.4](#) for programming the eLogger HMI application with ISaGRAF.

- ** The ISaGRAF WinCE ViewPAC in this manual include: (abbreviation: VP-2xW7/4xx7)**
VP-25W7, VP-23W7, VP-4137 (Support ISaGRAF logic running in the PAC)
VP-25W6, VP-23W6, VP-4136 (Support InduSoft & ISaGRAF logic running in the same PAC)

Important Notice:

1. ISaGRAF WinCE ViewPAC support only High profile I-8K and I-87K I/O cards in its slot 0 to 2. Please refer to the accompanying CD-ROM: `\napdos\isagraf\vp-25w7-23w7\english-manu\ Datasheet files.`
2. Please always set a **fixed IP** address to the ISaGRAF WinCE ViewPAC. (No DHCP)
Please refer to below ISaGRAF WinCE ViewPAC CD-ROM for detailed ISaGRAF User's Manual.
`\napdos\isagraf\vp-25w7-23w7\english-manu\ "user_manual_i_8xx7.pdf"`

NOTE:

The ISaGRAF WinCE ViewPAC supports ISaGRAF programming method & provides Web HMI solution by default. If user would like to program the VP-2xW7 by using both ISaGRAF & (EVC++ 4.0 or VS.NET 2008 or C# .NET), it is also possible. Please refer to [Chapter 6](#), [Chapter 7](#), [Chapter 10](#).

2.1 Step 1 - Installing The ISaGRAF Software

The user has to install two software before he can program the ISaGRAF ViewPAC controller system. They are

- A. ISaGRAF Workbench &
- B. ICP DAS Utilities For ISaGRAF

User has to purchase at least one pcs. of ISaGRAF (Ver. 3.4x or Ver. 3.5x ISaGRAF-256-E or ISaGRAF-256-C or ISaGRAF-32-E or ISaGRAF-32-C) to install on his PC to edit, download, monitor & debug the controller system. Item (B) is free and it is burned inside the CD-ROM which is delivered with the ISaGRAF WinCE ViewPAC controllers.

Operating system Requirements:

One of the following computer operating systems must be installed on the target computer system before you can install the ISaGRAF Workbench software program.

- Windows 98, Windows 2000 or Windows XP
- Windows NT Version 3.51 or Windows NT Version 4.0
- Windows XP or Vista or Windows 7 (refer to [FAQ-117](#) or [2.1.4](#))

Steps To Install The ISaGRAF Workbench:



If your PC OS is Windows Vista or Windows 7 (32-bit), refer to [2.1.4](#).
If your PC OS is Windows 7 (64-bit), please refer to [2.1.5](#).

1. Insert the ISaGRAF Workbench CD into your CD-ROM drive.
If your computer does not auto-start the installation, use the Windows Explorer and go to the CD-ROM drive where the Workbench CD is installed.

2. Double-click on the "install.bat" file listed on the ISaGRAF CD.
If the "install.bat" file is not found on your ISaGRAF CD, then double-click on the "ISaGRAF.exe" file to start the installation process.

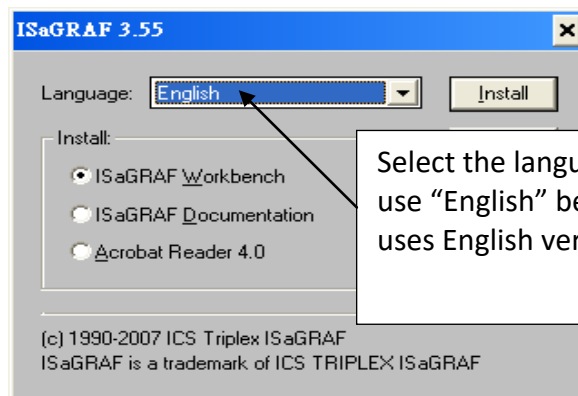

Select the language. Recommend to use "English" because this manual uses English version.

3. To begin the ISaGRAF 3.x software program, click the Windows [Start] button, then click [Programs], and you should see the ISaGRAF program group as illustrated below. Click "Projects" can start ISaGRAF software.

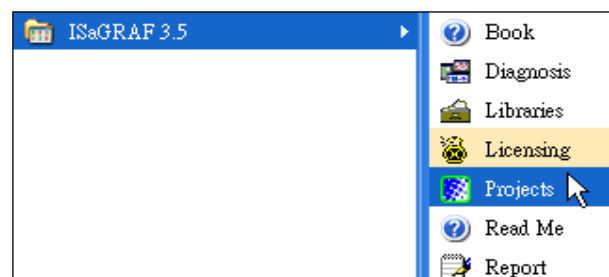

2.1.1 The Hardware Protection Device (Dongle & USB Key-Pro)

You must install the hardware protection device (dongle on your computers parallel port or USB Key-Pro for ISaGRAF 3.51 or latter Version) provided with the ISaGRAF software for the ISaGRAF program to achieve fully authorized functionality. (ISaGRAF-32-E & ISaGRAF-32-C **DO NOT** need dongle or key-pro)

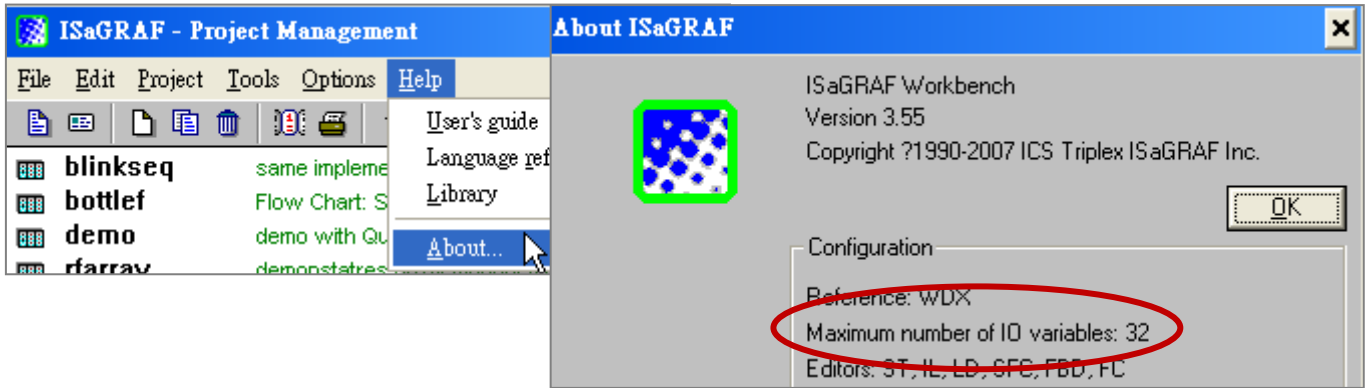

While using ISaGRAF and the dongle is plugged well, if the “Help” – “About” says “Maximum number of IO variables: 32”, it means ISaGRAF workbench cannot find the dongle well. Please reset your PC and then check the “Help” – “About” again. If it still displays “Maximum number of IO variables: 32”, the dongle driver may not be installed well. Please do the following steps.

Dongle Protection:

Please execute the ISaGRAF CD_ROM \Sentinel5382\setup.exe for ISaGRAF-80 or \Sentinel\setup.exe for other ISaGRAF version and then reset the PC again.

USB Key-Pro Protection:

1. To make your PC recognize the ISaGRAF USB protection-key, please un-plug the USB protection-key from your USB port first, then run “\Sentinel\SSD5411-32bit.exe” in the ISaGRAF 3.55 CD-ROM (or later version) after you have installed the ISaGRAF. Then please reset your PC.
2. To run ISaGRAF Ver. 3.5x, please always plug the USB protection-key in the PC’s USB port.

2.1.2 Important Notice For Window 2000 Users

If you close some ISaGRAF windows, it holds about 20 ~ 40 seconds (No response). This may caused by the procedure “CTFMON.EXE” of Windows 2000. First click on “Ctrl & Alt & Del” at the same time to stop the “CTFMON.EXE” process, and then you may create a short cut for the “ISaGRAF project manager”. And then check on “run in separate memory space” option in the shortcut property.

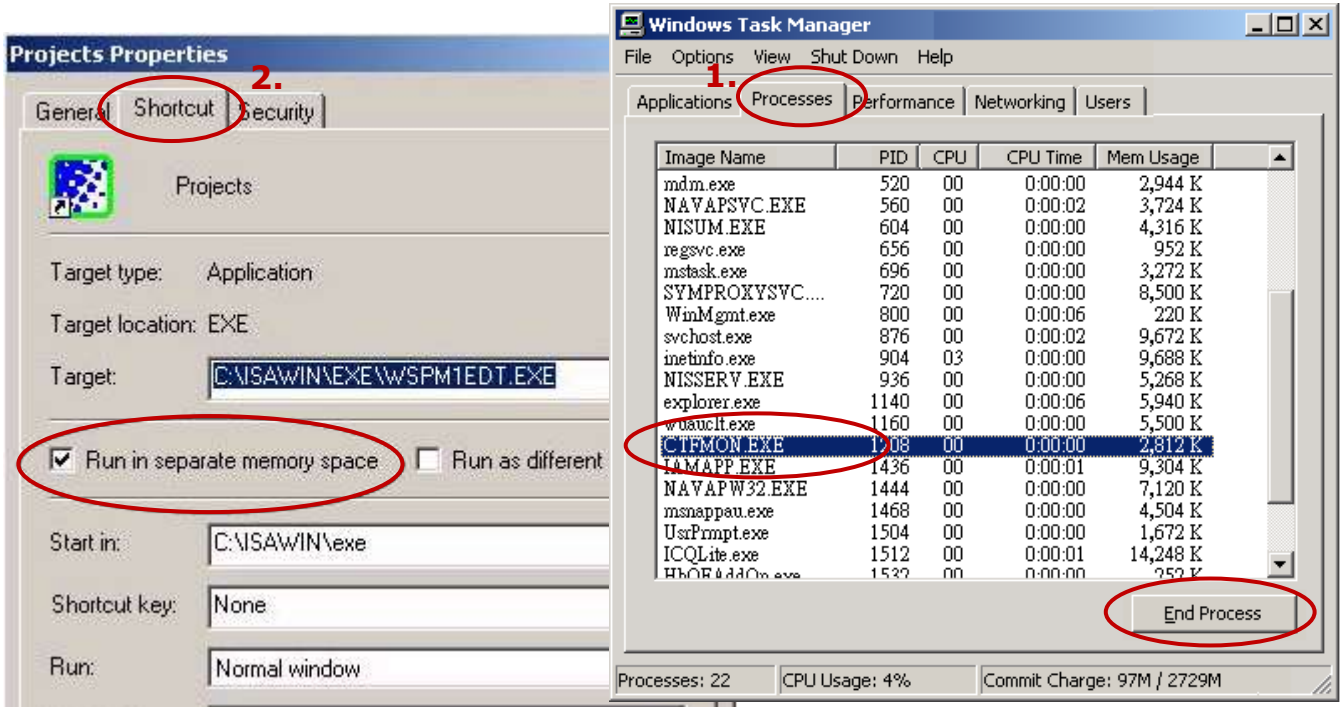

2.1.3 Important Notice for Window NT Users

If your computer is using the Windows NT operating system, you will need to add one line to the “isa.ini” file in the ISaGRAF Workbench “EXE” subdirectory.

```
C:\ISAWIN\EXE\isa.ini
```

You can use any ASCII based text editor (such as Notepad or UltraEdit32) to open the “isa.ini” file. Locate the [WS001] header in the “isa.ini” initialization file (it should be at the top of the file). Anywhere within the [WS001] header portion of the “isa.ini” initialization file, add the entry shown below within the [WS001] header:

```
[WS001]
NT=1
Isa=C:\ISAWIN
IsaExe=C:\ISAWIN\EXE
Group=Samples
IsaApl=c:\isawin\smg
IsaTmp=C:\ISAWIN\TMP
```

2.1.4 Important Notice for Windows Vista or Windows 7 (32-bit) Users

Before installing the ISaGRAF, if your operating system is Windows Vista or Windows 7 (32-bit), please change the User Account Control settings to avoid some of the setup restrictions.

How to disable “UAC” (User Account Control) ?



The “UAC” (User Account Control) setting requires administrator-level permission.

1. From the “Start” menu, choose “Control Panel > User Accounts and Family Safety > User Accounts”, then click “Change User Account Control settings” or “Turn User Account Control on or off”.



2. After clicking, it will show up the screen as below.

Windows Vista:

Uncheck the option – “Use User Account Control(UAC) to help you protect your computer” and then click on “OK”.

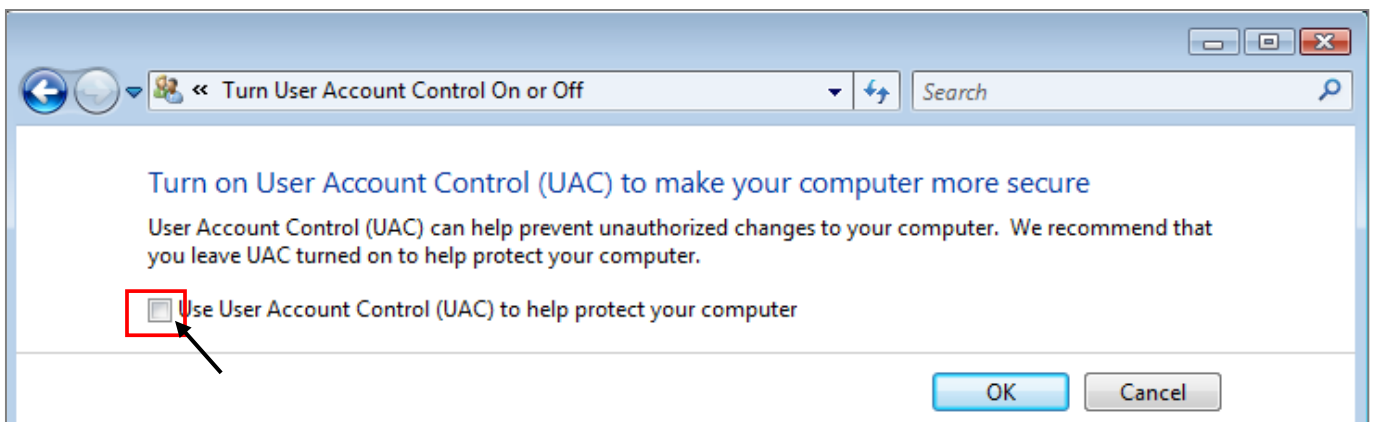

Windows 7:

Move the slider down to “Never Notify” and then click on “OK”.

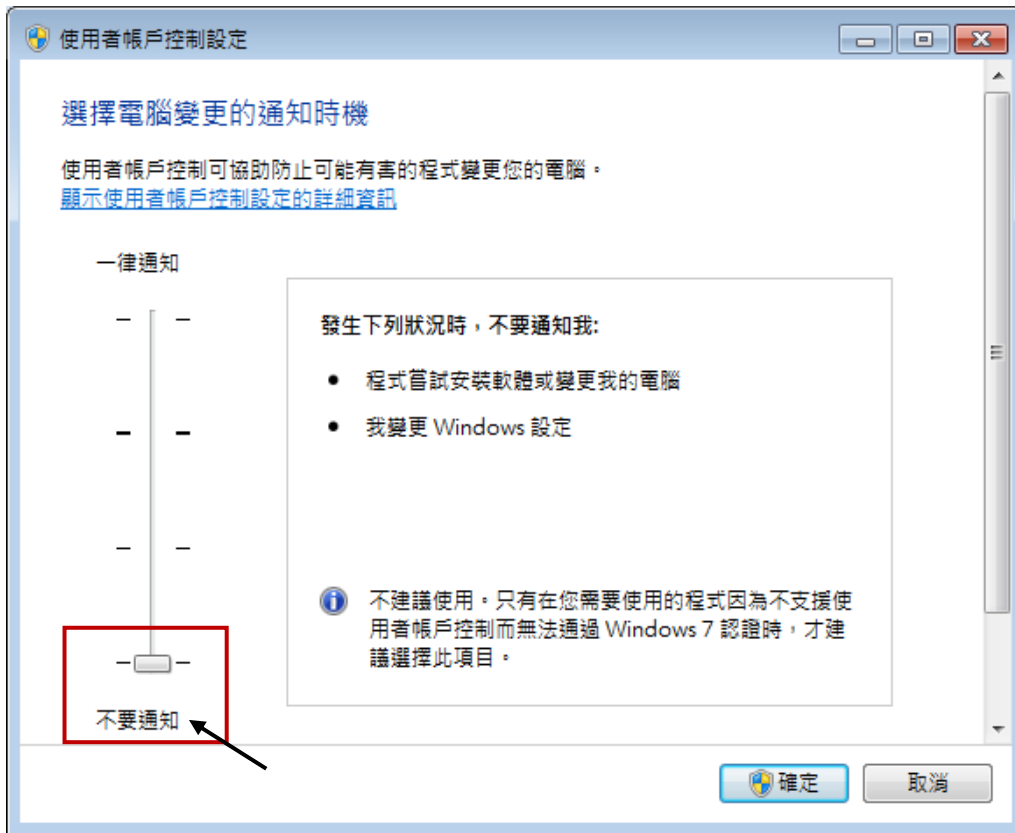

3. Reboot your computer to apply the change.

4. After rebooting, please refer to section [2.1 Installing the ISaGRAF Software](#).

2.1.5 Important Notice for Windows 7 (64-bit) Users

Because the ISaGRAF Workbench can only be installed on a 32-bit version of Windows operating system, users can use the following ways to create a proper installation environment for the ISaGRAF Workbench 3.55. If using Windows XP Mode that can be installed on 64-bit version of Windows 7 Professional, Enterprise, and Ultimate editions. If using VMware Workstation/Player that can be installed on any 64-bit version of Windows OS (e.g., Windows 7 or Windows 8).

Installing the Virtual PC and XP Mode:

1. Download Windows Virtual PC and Windows XP Mode installers from the Windows Virtual PC Web site (<http://go.microsoft.com/fwlink/?LinkID=160479>)
2. Double-click on "WindowsXPMode_**nn-NN**.exe" (where nn-NN is the locale, e.g. en-US) and follow the instructions in the wizard to install Windows XP Mode.
3. Double-click on "Windows6.1-KB958559-x64.msu" to install Windows Virtual PC °
4. Reboot your computer.
5. After rebooting, click on "Star > All Programs > Windows Virtual PC" and then click Windows XP Mode.
6. Follow the instructions in the wizard to complete Windows XP Mode Setup and Configuration. Record the password that is provided during the Setup because it is required to log on to your virtual machine.
7. Now, go back to [section 2.1](#) to install the ISaGRAF.

Using VMware Workstation/Player:

1. Download and install VMware Workstation 10 (trial version) on VMware website. https://my.vmware.com/web/vmware/info/slug/desktop_end_user_computing/vmware_workstation/10_0
2. Create a virtual machine running Windows XP (32-bit, SP3).
3. Install ISaGRAF Workbench 3.55 on a virtual machine.
4. Install ISaGRAF I/O Library on a virtual machine.
5. The related settings for a virtual machine.
6. Install USB dongle driver on a virtual machine.

More at www.icpdas.com > Support > FAQ > ISaGRAF Soft-Logic PAC > FAQ-174

2.1.6 Important Setting for Using Variable Arrays

Important setting for using variable arrays:

Please add two lines on the top of the **c:\isawin\exe\isa.ini** file to enable the usage of variable arrays.

```
[DEBUG]
Arrays=1
```

2.2 Step 2 - Installing The ICP DAS Utilities For ISaGRAF

The “ICP DAS Utilities For ISaGRAF” consists of 3 major items.

- I/O libraries for all ICP DAS ISaGRAF controllers.
- Modem_Link utility
- Auto-scan I/O utility

Note:

The ISaGRAF Workbench software program must be installed before attempting to install the “ICP DAS Utilities for ISaGRAF”. If you have not already installed the ISaGRAF Workbench program, please refer to [2.1 step 1](#) before continuing.

There is a CD-ROM supplied with each of the ISaGRAF ViewPAC controllers with the “ICP DAS Utilities for ISaGRAF”. Please insert the CD-ROM into your CD-ROM drive. Then run **CD-ROM: \napdos\isagraf\setup.exe** . Follow the steps to install it.

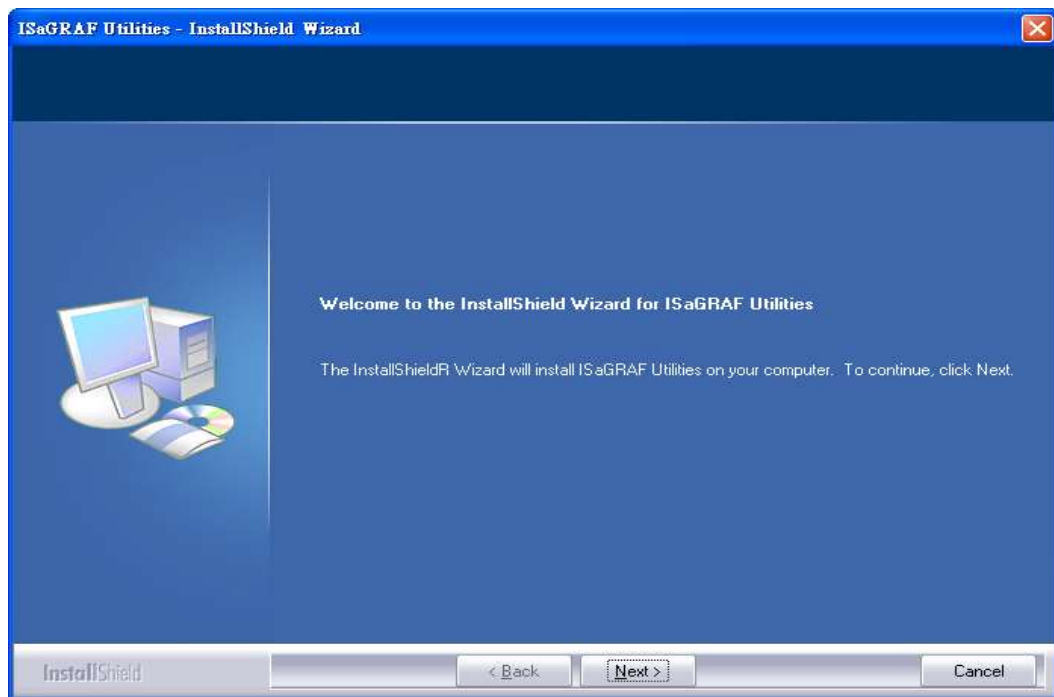

Note:

If “ICP DAS Utilities for ISaGRAF” is not in your CD-ROM, please download “**ICP DAS Utilities For ISaGRAF.zip**” from www.icpdas.com > [Product > Solutions > Soft PLC, ISaGRAF & Soft-GRAF HMI > ISaGRAF > Driver](#).

2.3 Step 3 - Installing The Web Page Editor

This is an option. You may not need it if you are very familiar with the HTML design. It is also possible to use any text editor to build web pages. For example, “Notepad” on the windows 2000 or XP.

We will use “Microsoft Office FrontPage 2003” (or later version) to build web pages in this manual.

User may choose your prefer web page editor to do the same thing.

2.4 Working eLogger HMI with ISaGRAF SoftLogic

ICP DAS eLogger is an easy and useful HMI development tool which helps user to create user-friendly pictures and control items. (Recommend to use Soft-GRAF HMI, the performance is better. Please refer to [Section 2.5.](#))

eLogger HMI application can work with ISaGRAF softlogic application in the following PACs:

- WP-8147 / 8447 / 8847
- WP-8137 / 8437 / 8837
- VP-25W7 / 23W7 / 4137
- XP-8047-CE6 / 8347-CE6 / 8747-CE6

Please refer to www.icpdas.com > [Support](#) > [FAQ](#) > [ISaGRAF Soft-Logic PAC](#) > [FAQ-115](#) : “Working eLogger HMI with ISaGRAF SoftLogic in the WP-8xx7, VP-2xW7/4xx7 and XP-8xx7-CE6 PAC” for more information about programming an eLogger application.



2.5 Working Soft-GRAF HMI with ISaGRAF SoftLogic

Soft-GRAF is an HMI (Human Machine Interface) software developed by ICP DAS which allows user to create his colorful HMI application running with the control logic in the same ISaGRAF WinCE series PAC. Using the PAC with the Soft-GRAF support, user can easily edit its HMI screen by Soft-GRAF Studio and design the control logic by ISaGRAF software.



Feature:

- Support Various and Colorful HMI Objects:
 - Pages (Max. 200, Support Password Security)
 - Label (Normal, Reverse Type, Under-line)
 - Boolean Value (Normal, Reverse Type, Blinking)
 - Numeric Value (Normal, Scaling, Limit - Blink/Color/Text)
 - Message Value (Dynamic Message, Multi-language)
 - Button (Value, Title, Picture, Security, Confirm, Password)
 - Picture (Static, Dynamic, Boolean Picture)
 - Login/Logout
 - Bar Meter (Vertical, Horizontal, Scale, Unipolar, Bipolar)
 - Trace (1-axis, 2-axis)
 - Trend (Real-time, Historical)
 - Schedule-Control
 - Gauge Meter
 - Alarm Lists
 - Data Logger (Log data; support USB export or FTP upload)
 - Built-in Various Objects (Button, Gif, LED... will be More)
- Multi-language: English, Traditional Chinese, Simplify Chinese, Russian, etc.
- Support user designed graphics, e.g. JPG, PNG ...

Information and links:

- For more information, refer to FAQ 146:
www.icpdas.com > [Support](#) > [FAQ](#) > [ISaGRAF Soft-Logic PAC - 146](#)
Q: Soft-GRAF Studio V.x.xx Software & manual: Create a Colorful HMI in the ISaGRAF WinCE PAC
- The following ISaGRAF drivers support the Soft-GRAF:

ISaGRAF PAC	ISaGRAF Driver Version
XP-8xx7-CE6	Ver. 1.41 or later
XP-8xx7-Atom-CE6	Ver. 1.02 or later
WP-8xx7	Ver. 1.61 or later
WP-5147	Ver. 1.07 or later
VP-2xW7/4xx7	Ver. 1.53 or later

The latest version of ISaGRAF driver:

http://www.icpdas.com/root/product/solutions/softplc_based_on_pac/isagraf/download/isagraf-link.html .

www.icpdas.com > > Product > [Solutions](#) > [Soft PLC, ISaGRAF & Soft-GRAF HMI](#) > [ISaGRAF](#) > ISaGRAF
Download List

Chapter 3 Setting Up A Web HMI Demo

**** The ISaGRAF WinCE ViewPAC in this manual include: (abbreviation: VP-2xW7/4xx7)**
VP-25W7, VP-23W7, VP-4137 (Support ISaGRAF logic running in the PAC)
VP-25W6, VP-23W6, VP-4136 (Support InduSoft & ISaGRAF logic running in the same PAC)

Important Notice:

1. ISaGRAF WinCE ViewPAC support only High profile I-8K and I-87K I/O cards in its slot 0 to 2. Please refer to the accompanying CD-ROM: \napdos\isagraf\vp-25w7-23w7\english-manu\ Datasheet files.
2. Please always set a **fixed IP** address to the ISaGRAF WinCE ViewPAC. (**No DHCP**). Recommend to use the NS-205/208 or RS-405/408 (RING SWITCH) Industrial Ethernet Switch for them.

3.1 Web Demo List

The Web page location:

ISaGRAF WinCE ViewPAC CD-ROM: \napdos\isagraf\vp-25w7-23w7\vp-webhmi-demo\

The respective ISaGRAF project location:

ISaGRAF WinCE ViewPAC CD-ROM: \napdos\isagraf\vp-25w7-23w7\demo\

Demo list:

Name	Description	IO board
sample	A Web HMI sample	No I/O board
example1	A simple example listed in Chapter 4	slot 0: I-87055W
vphmi_01	Display controller's date & time	No I/O board
vphmi_02	DI & DO demo	slot 0: I-87055W
vphmi_03	Read / Write Long, float & Timer value	No I/O board
vphmi_04	Read / Write controller's String	No I/O board
vphmi_05	Multi-Pages demo Page menu is on the Left	slot 0: I-87055W
vphmi_05a	Multi-Pages demo Page menu is on the Top	slot 0: I-87055W
vphmi_06	AIO demo, scaling is in ISaGRAF	slot 1: I-87024W slot 2: I-8017HW
vphmi_07	AIO demo, scaling is in PC	slot 1: I-87024W slot 2: I-8017HW
vphmi_08	download controller's file to PC	slot 0: I-87055W
vphmi_09	pop up an alarm window on PC	slot 0: I-87055W
vphmi_11	Trend curve.	slot 1: I-87024W slot 2: I-8017hW
vphmi_12	Record 1 to 8 Ch. i8017HW 's volt every 50ms and draw trend curve by M.S.Excel	slot 2: I-8017hW slot 1: I-8024W
vphmi_13	Record 1 to 4-Ch. i8017HW's voltage every 10ms and draw trend curve by M.S.Excel	slot 2: I-8017hW slot 1: I-8024W

3.2 Steps To Set Up A Web HMI Demo

3.2.1 Step 1 – Set up The Hardware

A. Please have one VP-25W7 and then plug one I-87055W board in its slot 0.

If you don't have the I-87055W (8 IN & 8 OUT board), please follow the same steps as below however your Web HMI demo may be replaced to "vphmi_01" not "vphmi_05"

B. Prepare one Ethernet cable and then connect them to the ViewPAC. Keyboard is using the software keyboard on the bottom-right of the ViewPAC screen)

C. Power up the ViewPAC.

3.2.2 Step 2 - Setting The Web Options

A. Please refer to the [Appendix A.3](#) to set a fixed IP address to the ViewPAC. (No DHCP)

B. Check on "Enable Web HMI" and then click on "Setting", Please check the "Enable Account Security" and then click on "Edit" to set (username , password). **Then remember to click on "OK"**

Note: If "Enable Account Security" is not checked, any user can easily get access to your ViewPAC through the Internet Explorer.

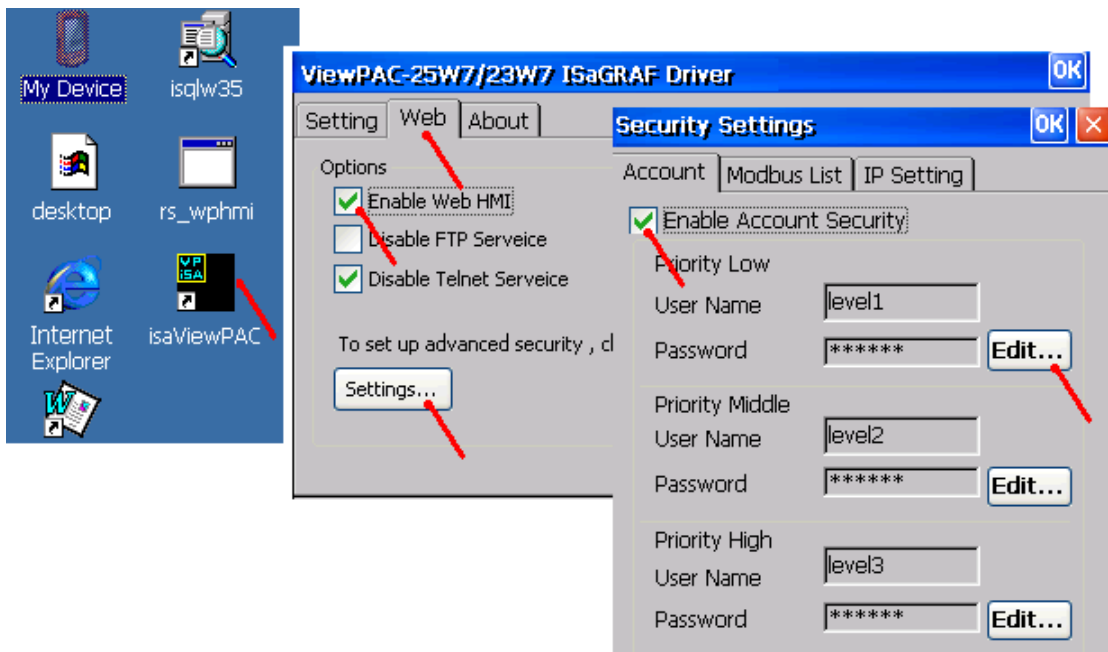

3.2.3 Step 3 - Download ISaGRAF Project

Please download ISaGRAF project "vphmi_05" to the VP-25W7. This project is in the VP-2xW7/4xx7 CD-ROM:\napdos\isagraf\vp-25w7-23w7\demo\ "vphmi_05.pia"

vphmi_05 demo need one I-87055W (8 IN & 8 OUT board). If you don't have it, you may download "vphmi_01" (CD-ROM:\napdos\isagraf\vp-25w7-23w7\demo\ "vphmi_01.pia")

If you know how to restore "vphmi_05.pia" to your ISaGRAF Workbench and download it to the controller, please go ahead to the section 3.2.4. However if you don't know it, please refer to the below steps. Please make sure the ISaGRAF Workbench is already installed to your PC. (Refer to the [section 2.1](#) & [2.2](#))

Steps To Backing Up & Restoring An ISaGRAF Project:

For archiving purposes you can "Back Up" and "Restore" an ISaGRAF project. For example, you may want someone to test your program or email to service@icpdas.com for ICP DAS's ISaGRAF technical service.

3.2.3.1 Backing Up An ISaGRAF Project

Open the "ISaGRAF Project Management", select "Tools" from the menu bar, click on "Archive", and then click on "Projects". An "Archive Projects" window will open which allows you to designate where you want to save the ISaGRAF project to. Click on the name of the ISaGRAF project you want to backup, and then click on the "Backup" button. You can compress the size of the file you have backed up by clicking on the "Compress" checkbox BEFORE you click on the "Backup" button.

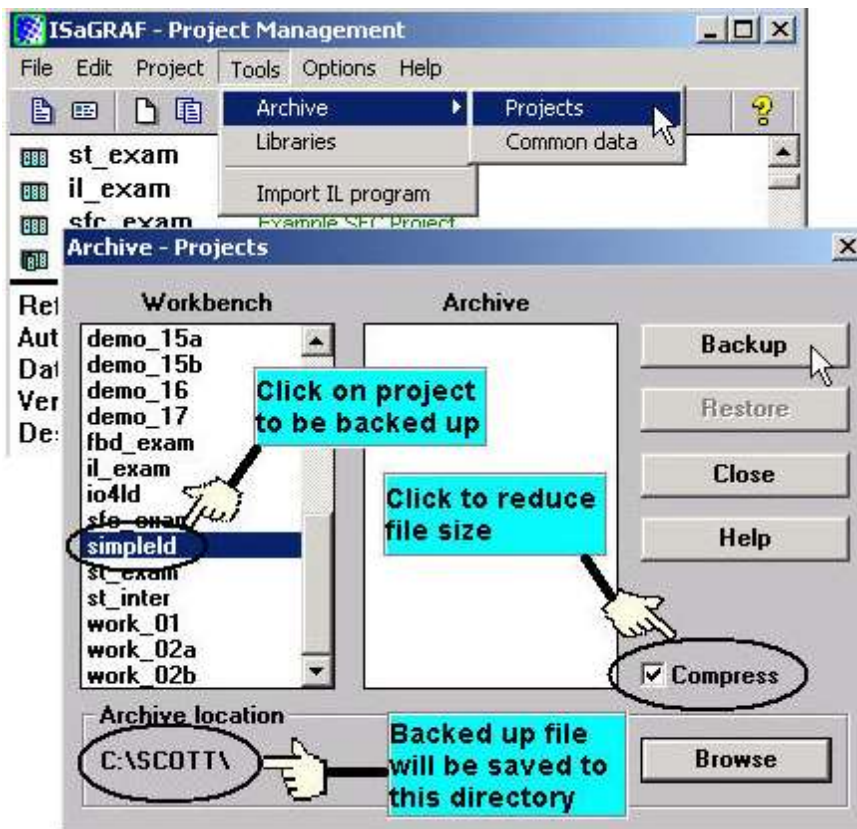

Then you will now find the backed up ISaGRAF project file in the "Archive" location you have designated. In the example above, the name of the backed up file is "simpleld.pia".

3.2.3.2 Restoring An ISaGRAF Project

To restore an ISaGRAF project from a backed up file (*.pia), use the same method as above to access the "Archive Projects" window, click on the name of the project you want to restore from the "Workbench" window, then click on the name of the backed up file from the "Archive" window, then click on the "Restore" button. The ISaGRAF project will now be restored to the sub-directory you designated.

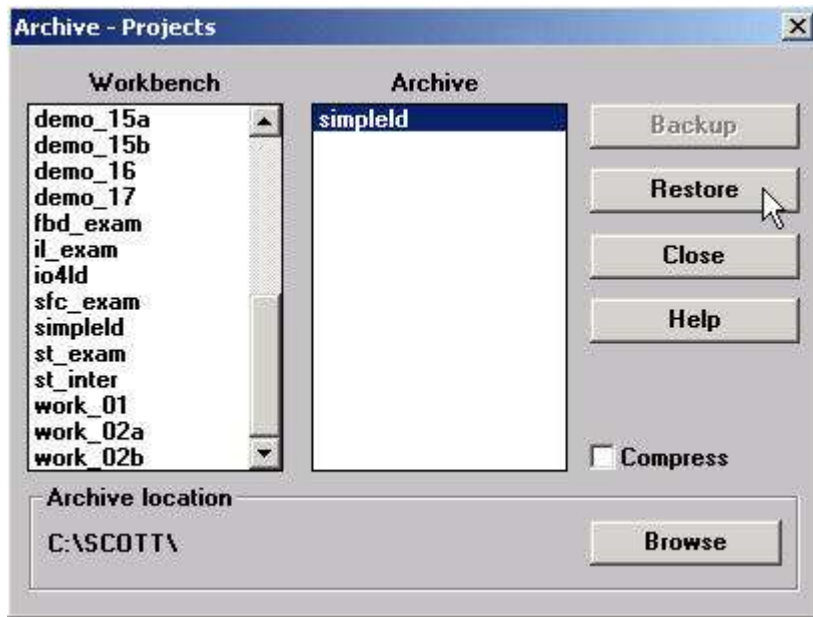

3.2.3.3 Steps To Download a ISaGRAF Project To The Controller:

Double click on the "vphmi_05" to get into the project. Then click on "Link setup".

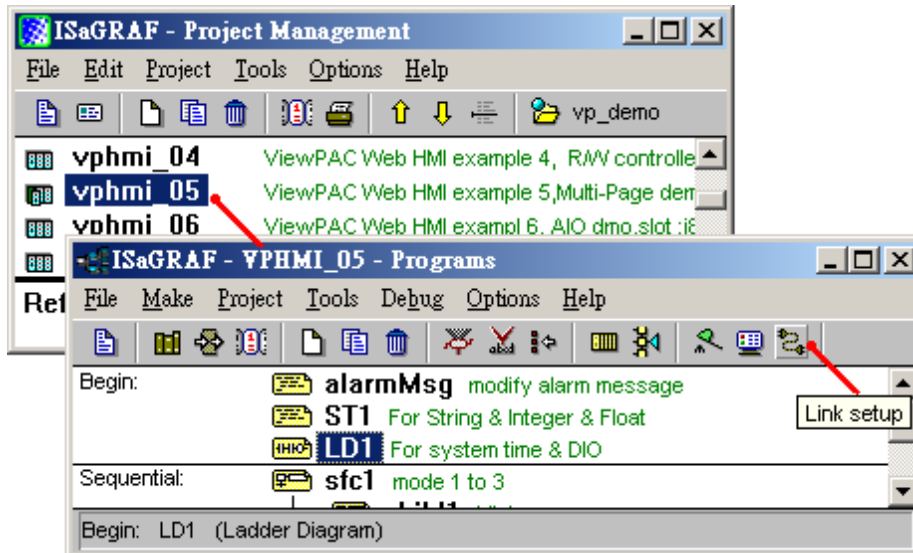

Click on “Setup” first and then entering the IP address of your controller. The port number should be 502.

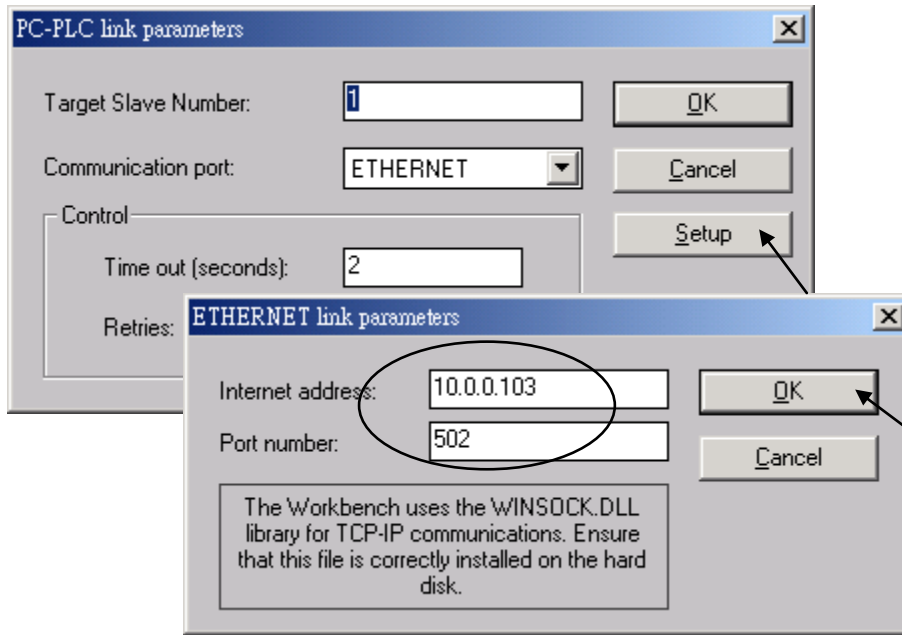

To download “vphmi_05” project to the VP-25W7, Click on “Debug”. If communication is established, click on “stop” first to stop the old project running in the VP-25W7.

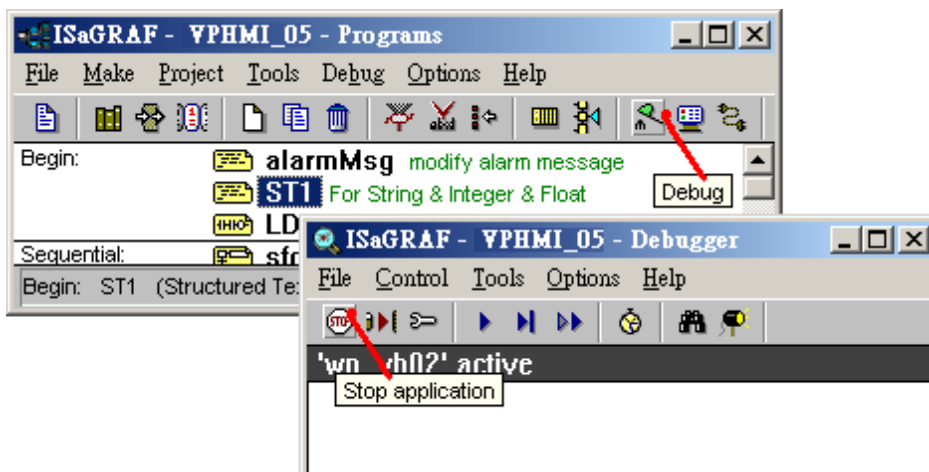

Then click on “Download” to download it to the controller.

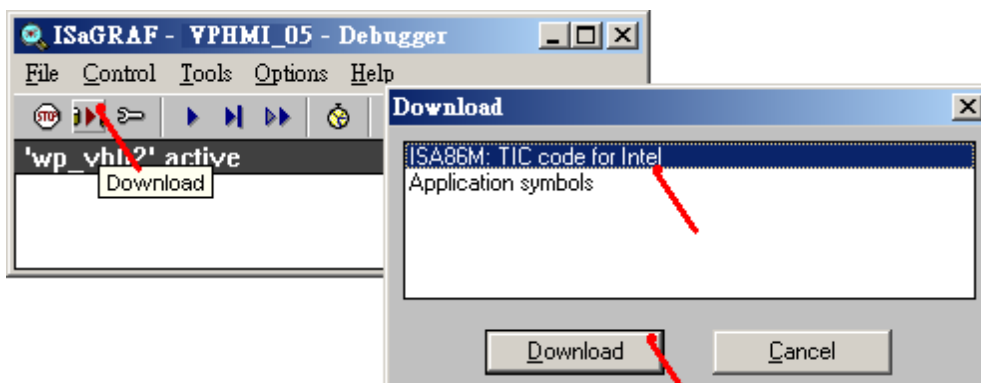

3.2.4 Step 4 - Download Web Pages To The ViewPAC

A. Please copy all files in the CD-ROM:

From VP-2xW7/4xx7 CD:

\napdos\isagraf\vp-25w7-23w7\vp-webhmi-demo\vphmi_05\ *.*

To the VP-25W7's

\Micro_SD\Temp\HTTP\WebHMI\

vphmi_05 demo need one I-87055W in its slot 0. If you don't have the I-87055W (8 IN & 8 OUT board), you may download "vphmi_01"

B. Since the Web Pages are modified or new copied, please run "rs_wphmi.exe" to reset the Web server. **The "rs_wphmi.exe" must be run every time when user has modified any file in the ViewPAC's \Micro_SD\Temp\HTTP\WebHMI**

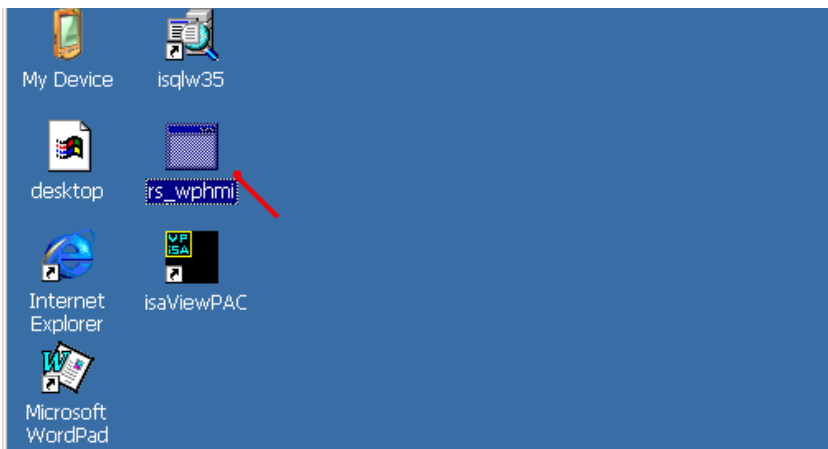

3.2.5 Step 5 - Show Time

Please run Internet Explorer (Rev. 6.0 or higher), key in the IP address of your VP-25W7. For example: 61.218.42.10 or <http://61.218.42.10>

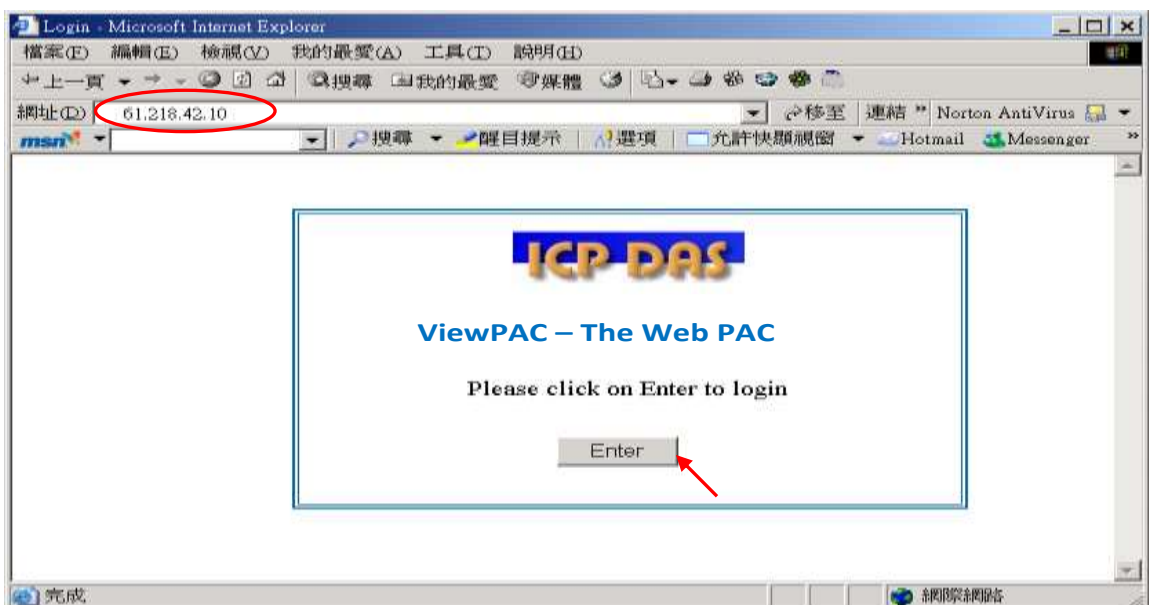

Chapter 4 Programming A Web HMI Example

**** The ISaGRAF WinCE ViewPAC in this manual include: (abbreviation: VP-2xW7/4xx7)**
VP-25W7, VP-23W7, VP-4137 (Support ISaGRAF logic running in the PAC)
VP-25W6, VP-23W6, VP-4136 (Support InduSoft & ISaGRAF logic running in the same PAC)

Important Notice:

1. ISaGRAF WinCE ViewPAC support only High profile I-8K and I-87K I/O cards in its slot 0 to 2. Please refer to the accompanying CD-ROM: \napdos\isagraf\vp-25w7-23w7\english-manu\ Datasheet files.
2. Please always set a **fixed IP** address to the ISaGRAF WinCE ViewPAC. (**No DHCP**). Recommend to use the NS-205/208 or RS-405/408 Industrial Ethernet Switch for them.

This chapter shows you how to build a simple ISaGRAF project and its Web HMI pages.

Please refer to CD-ROM: \napdos\isagraf\vp-25w7-23w7\english-manu\ "user_manual_i_8xx7.pdf"-
Section 2.1 for detailed ISaGRAF programming basics.

If user would like to program ViewPAC by using both ISaGRAF & (EVC++ or VS.NET), it is also possible.
Please refer to [Chapter 6](#), [Chapter 7](#), [Chapter 10](#).

4.1 Writing A Simple ISaGRAF Program

We are going to use ISaGRAF Workbench to write a simple ISaGRAF example program, then download it to the VP-25W7 controller (with one **I-87055W** I/O board in its slot 0) to make it work. If you haven't installed "ISaGRAF" & "ICP DAS Utilities for ISaGRAF", please go back to read [chapter 2](#).

This example contains one Ladder program.

(This demo program resides at the ISaGRAF WinCE ViewPAC CD-ROM:
 \napdos\isagraf\vp-25w7-23w7\demo\ "example1.pia")

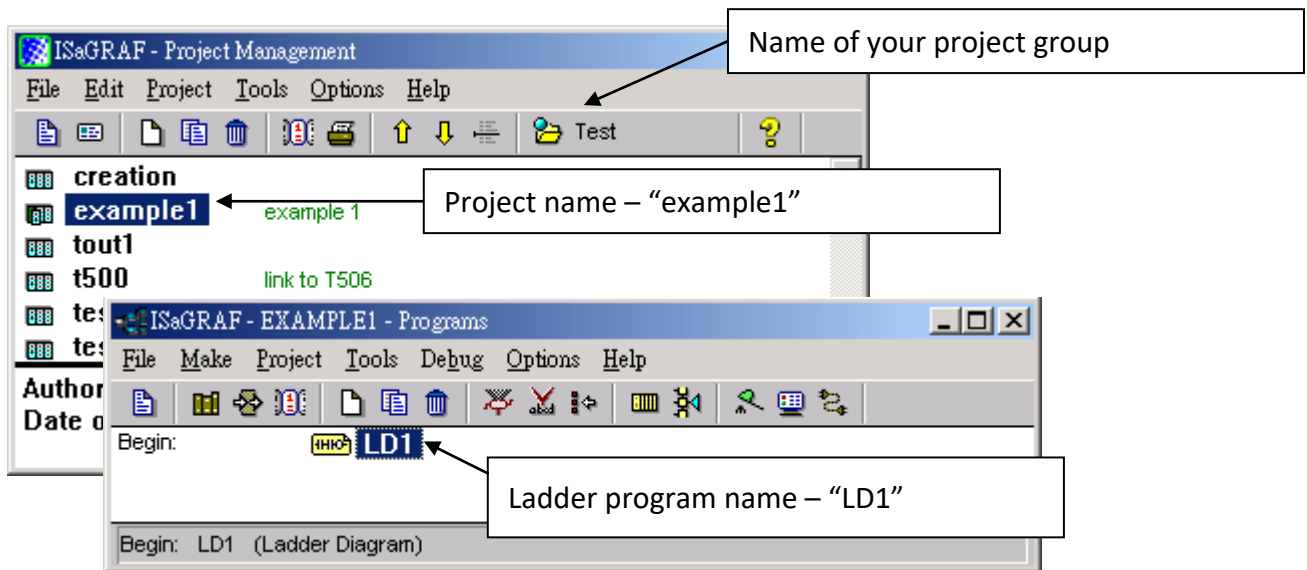

Variables declaration:

Name	Type	Attribute	Description
OUT01	Boolean	Output	Output 1 in the I-87055W, Modbus network addr = 1
OUT02	Boolean	Output	Output 2 in the I-87055W, Modbus network addr = 2
K1	Boolean	Input	Input 1 in the I-87055W, Modbus network addr = 11
K2	Boolean	Input	Input 2 in the I-87055W, Modbus network addr = 12
T1	Timer	Internal	Time Period of blinking, initial value set as T#8s Modbus network addr = 21

Ladder Logic Program Outline:

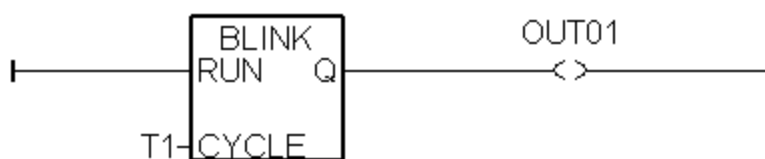

4.1.1 Open ISaGRAF-Project Management

Click on the Windows "Start" button, then click on "Programs", then click on "ISaGRAF 3.4", (or ISaGRAF 3.5) then click on "Projects" as shown below.

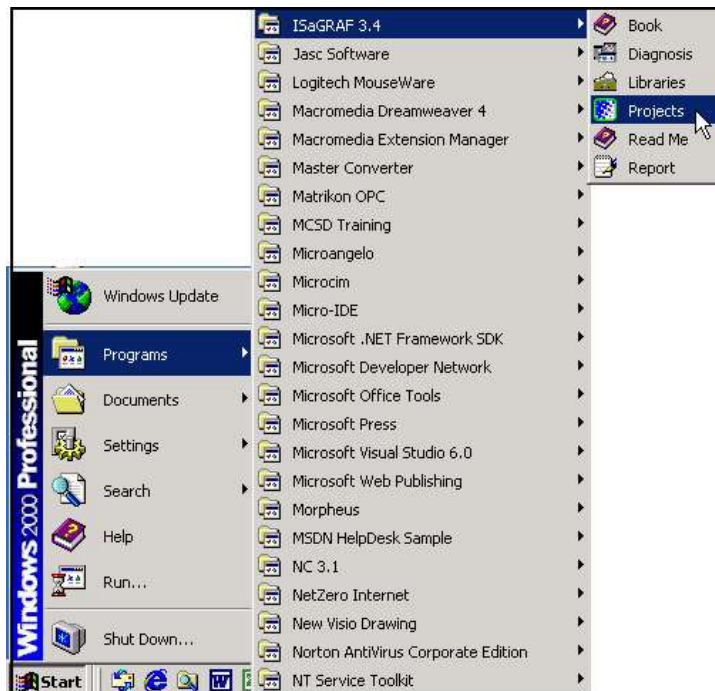

4.1.2 Creating An ISaGRAF User's Group

Click on the "Select Project Group", and then click on "New Group", then type in the name for the new user's group you wish to create, and last click on "OK".

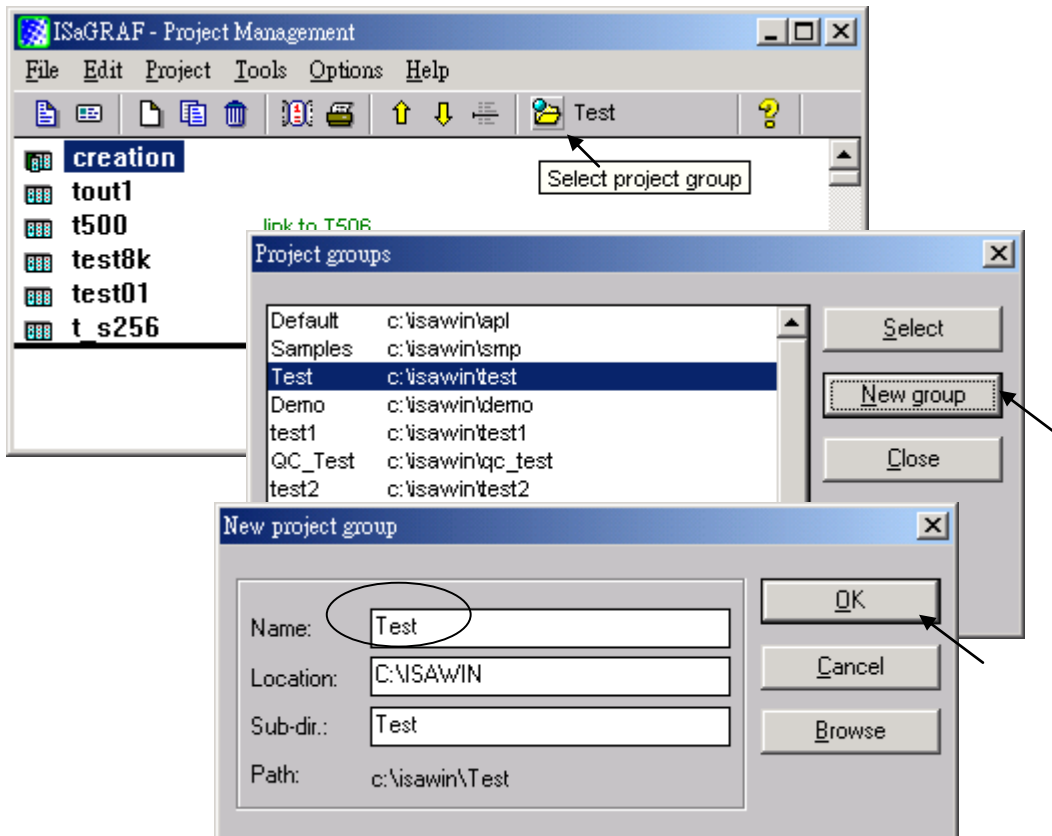

4.1.3 Creating A New ISaGRAF Project

To start a new ISaGRAF project, click on the "Create New Project" icon and then enter in the name for the new project. You can then enter additional information for your project by clicking on the "Edit" and then "Set Comment Text" menu as illustrated below.

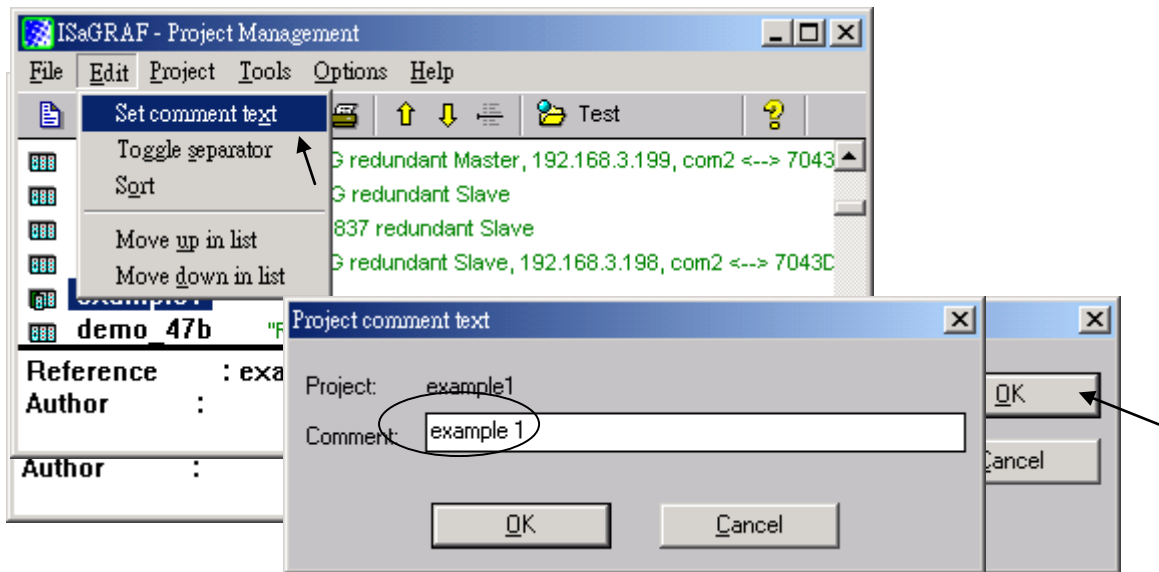

You will now see the name of the new project in the "Project Management" window. Double click on the name of the new project to open the new project.

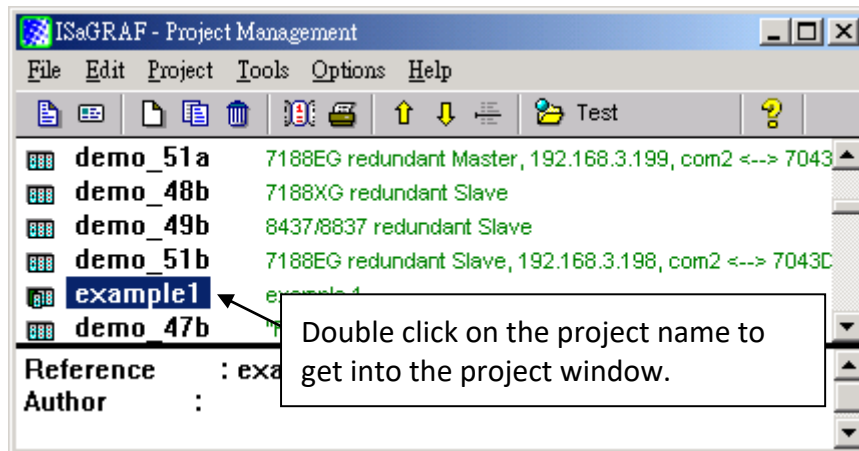

4.1.4 Declaring The ISaGRAF Project Variables

Before you can start creating an ISaGRAF program, you must first declare the variables that will be used in the ISaGRAF program.

Boolean Variable:

To begin this process, first click on the "Dictionary" icon and then click on the "Boolean" tab to declare the **Boolean variables** that will be used in our example program.

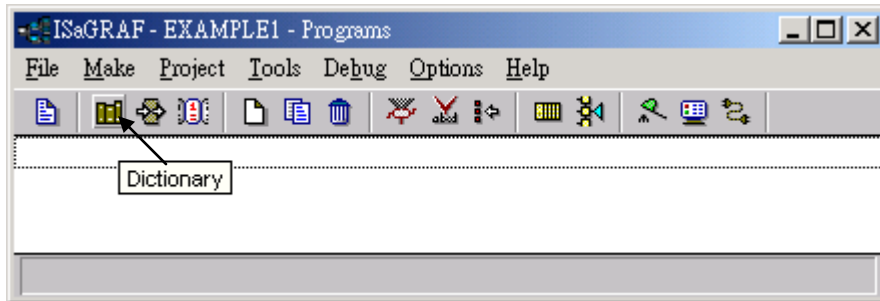

To declare the program variables for the ISaGRAF project, double click on the colored area below the "Boolean" tab, and a "Boolean Variable" window will open. Enter in the name of the variable to be used in the project. For the purpose of this example program the variable "Boolean Variable Name" is "K1", and "Input 1 in the I-87055W board" is added to the "Comment Section". The next item that must be declared is what type of "Attribute" the variable will possess. In this example program, K1's attribute will be an "Input". Then press the "Store" button to save it.

The new Boolean variable has now been declared.

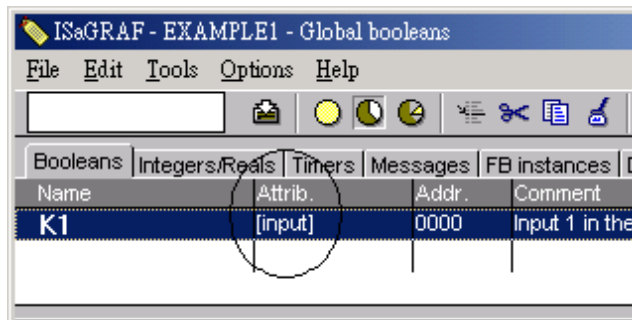

NOTE: You MUST make sure that the variable you have declared has the desired **Attribute** assigned. If you decide that you want to change a project variable's attribute, just double click on the variable name and you can reassign the attribute for the variable

Please follow the above same step to declare one another Boolean variable – "K2". Then you will have as below.

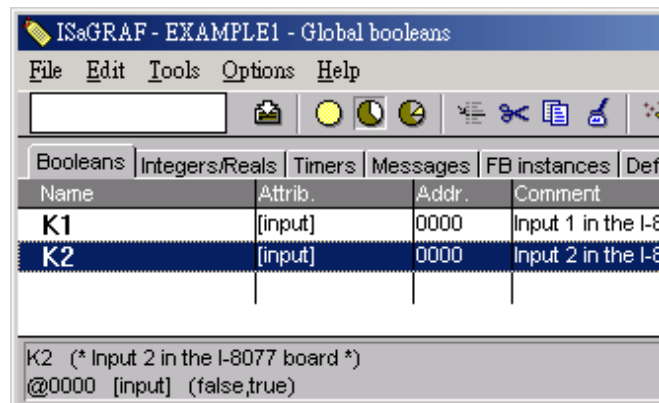

There are two outputs used in this example program named "OUT01 and OUT02". ISaGRAF provides a quick and easy way to declare like variables that are sequentially ordered.

Quick Declaration:

To begin this process, click on the "Quick Declaration" icon, and enter in the output number that you will start within the "Numbering" from and "To" field (this example uses from 1 to 2). Enter the "Symbol" name for the output variables being declared, and lastly, set the attribute to "Output"

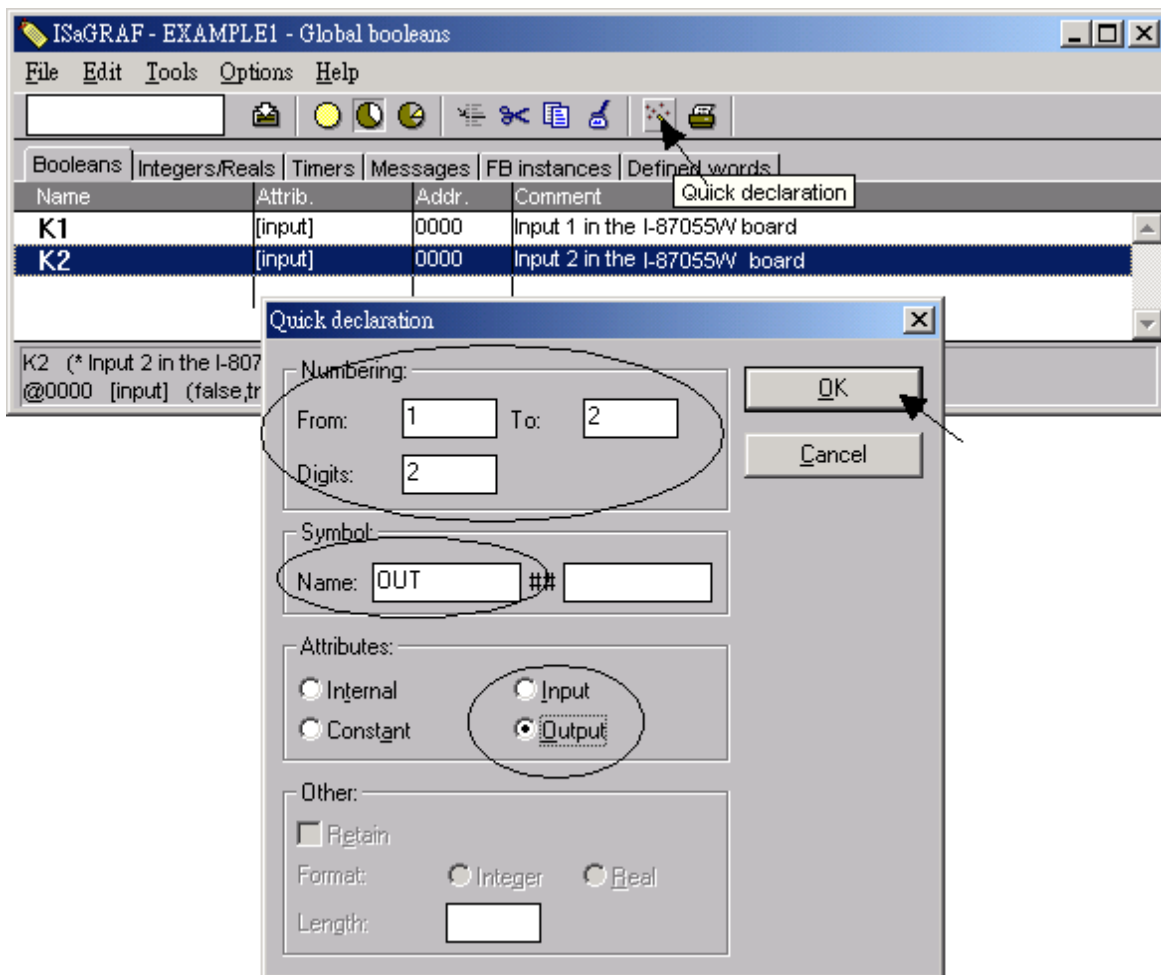

When you click on the "OK" button, all two outputs will be immediately added to the "Global Boolean" window. Click on Save to store them.

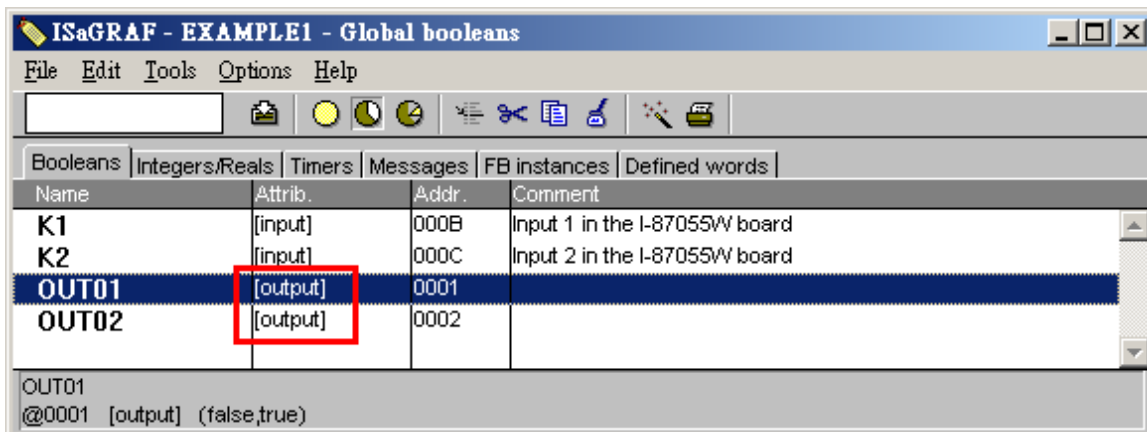

Timer Variable:

To declare the timer (T1) variable used in this example program, click on the "Timers" tab in the setup screen. Double click on the colored area and enter the Name as "T1", set the "Attributes" to "Internal", the "Initial Value" to "T#8s", then click on the "Store" button.

Then please click on "X" to close the "dictionary" window.

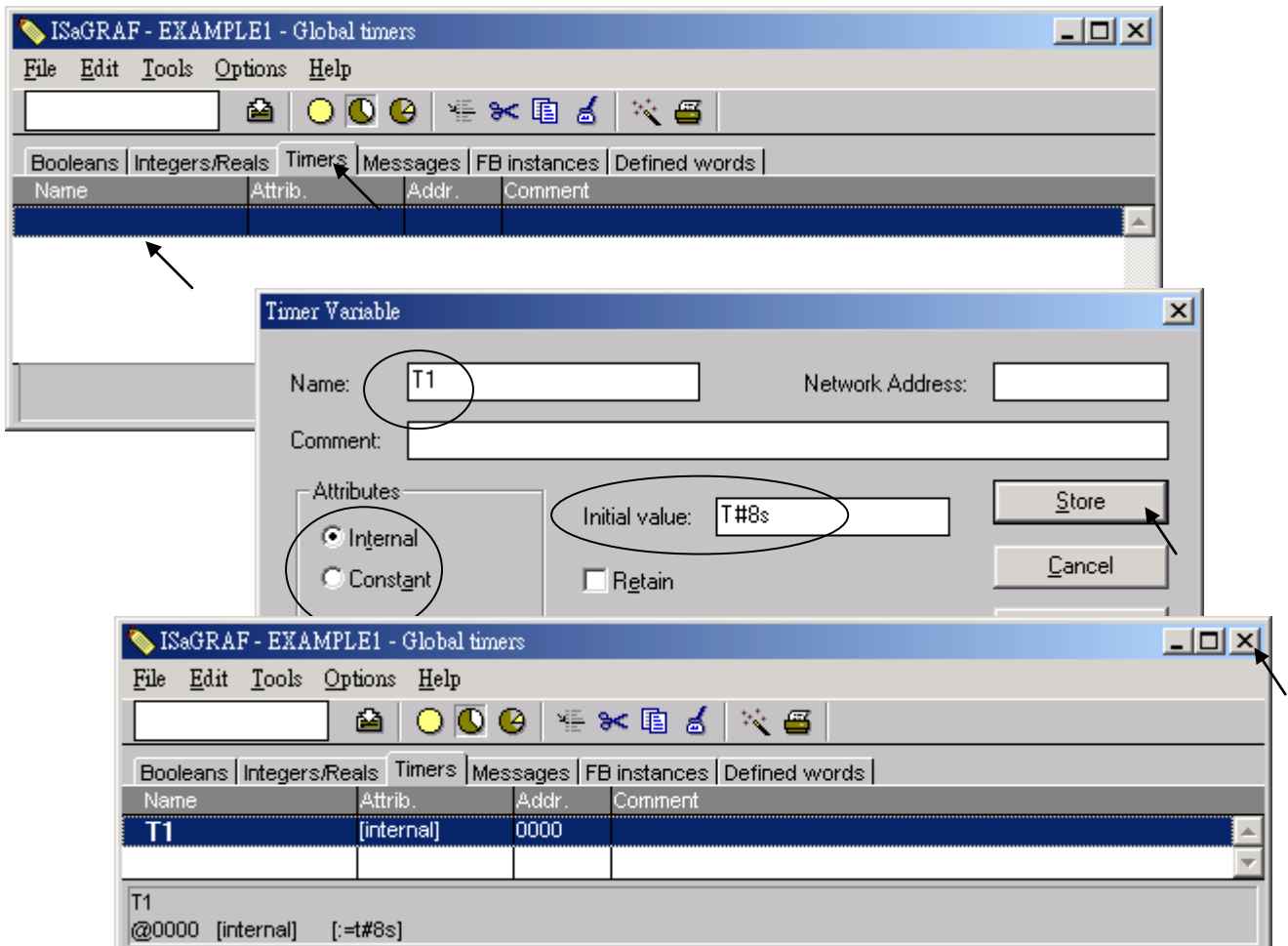

4.1.5 Assign Modbus Network Address No to Variables

The Web HMI will exchange the variable value with the ISaGRAF project if they have assigned the proper “Modbus network address”. The Web HMI only recognizes Modbus No. from 1 to 1024. However other SCADA software may R/W the Modbus No. from 1 to 8191 in the ISaGRAF WinCE ViewPAC.

Variables without assigning Modbus No. will not be available by Web HMI and other SCADA software or HMI devices. Please refer to VP-2xW7/4xx7 CD-ROM:

\\napdos\isagraf\vp-25w7-23w7\english-manu\ "user_manual_i_8xx7.pdf"

For section 4.1 & 4.2 for detailed information about assigning Modbus network address.

Please get into the dictionary, then click on “Tools – Modbus SCADA addressing map”

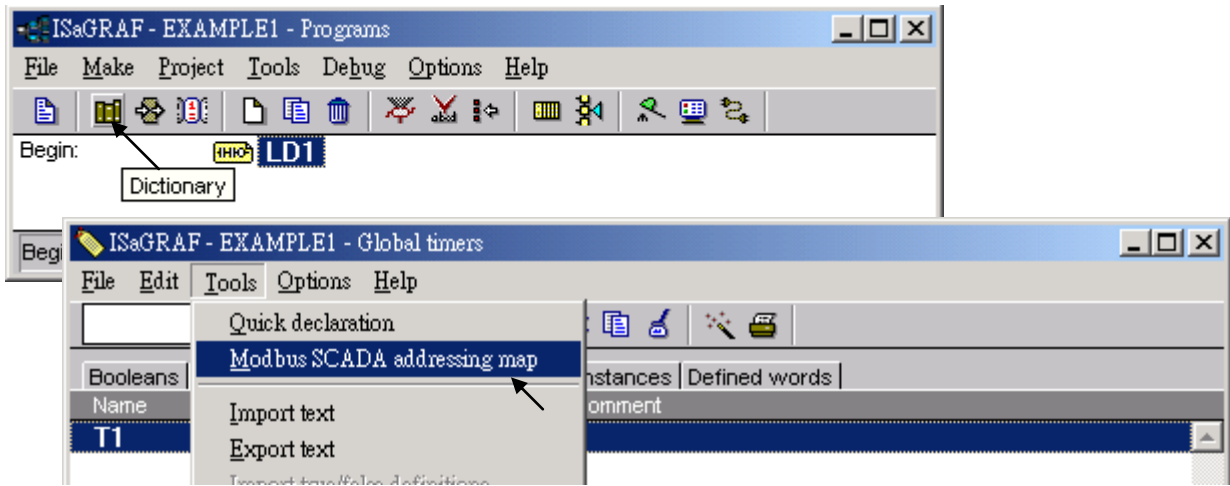

Please click on “Options – Decimal” , or it will use Hexadecimal format as default. First click on “00001” on the top window, and then double click on “OUT01” to attach it to the Modbus No. 1.

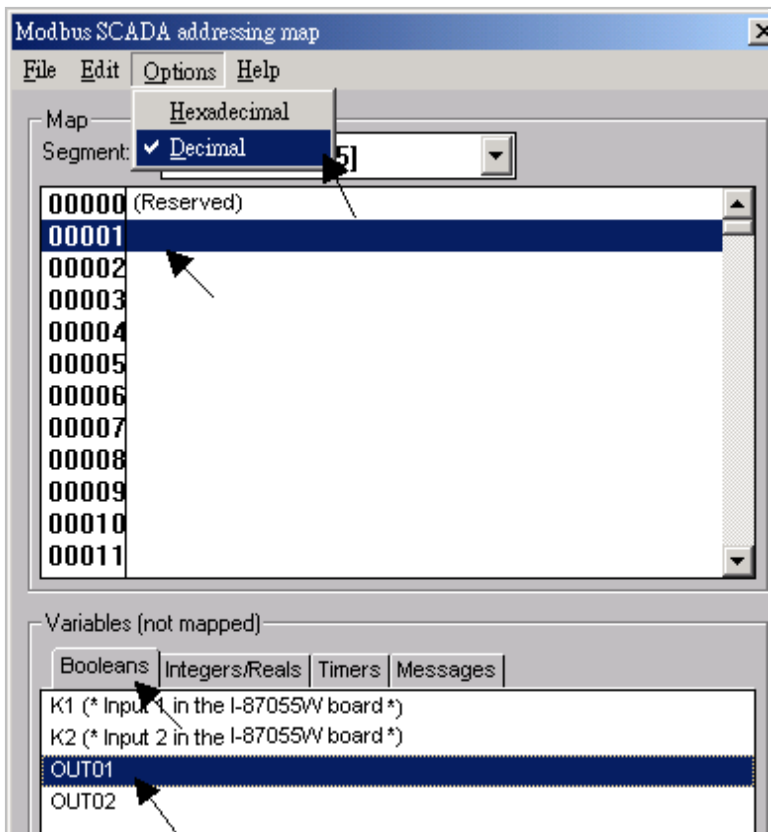

Please follow the same way to assign OUT01 to No.2 , K1 to No.11 , K2 to No.12 and then Timer variable T1 to No.21 . Then we have below window.

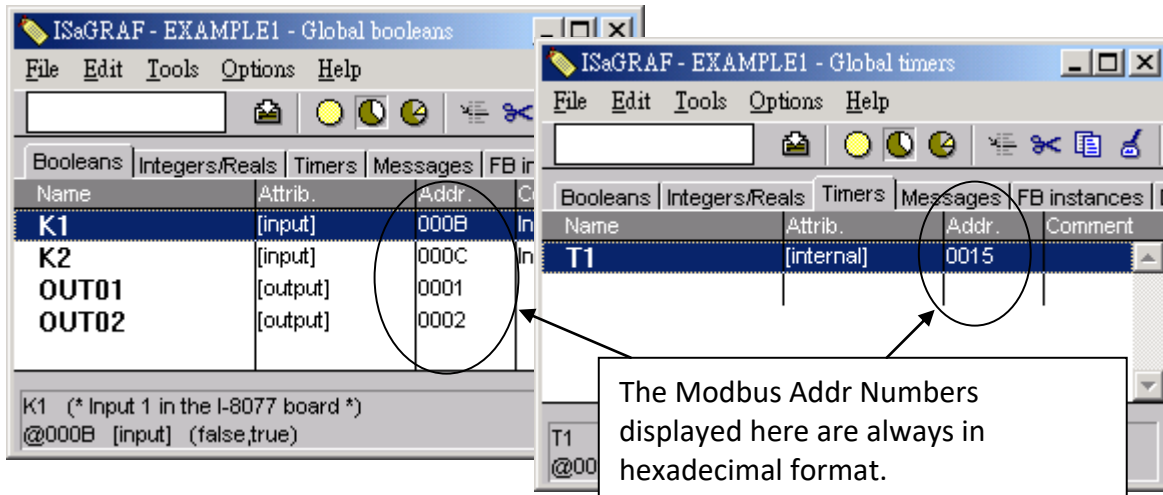

Very Important:

If assign Modbus No. to Long integer or Float or Timer variables, they should occupy two Modbus No. Please refer to VP-2xW7/4xx7 CD-ROM: \napdos\isagraf\vp-25w7-23w7\english-manu\ "user_manual_i_8xx7.pdf" - Section 4.2 for detailed information.

4.1.6 Create The LD - "LD1" Program

ISaGRAF will run every program one time in each PLC scan cycle. Programs in the "begin" area will run first, then the "Sequential" area, and last the "End" area. An ISaGRAF cycle run in the way as the below scheme.

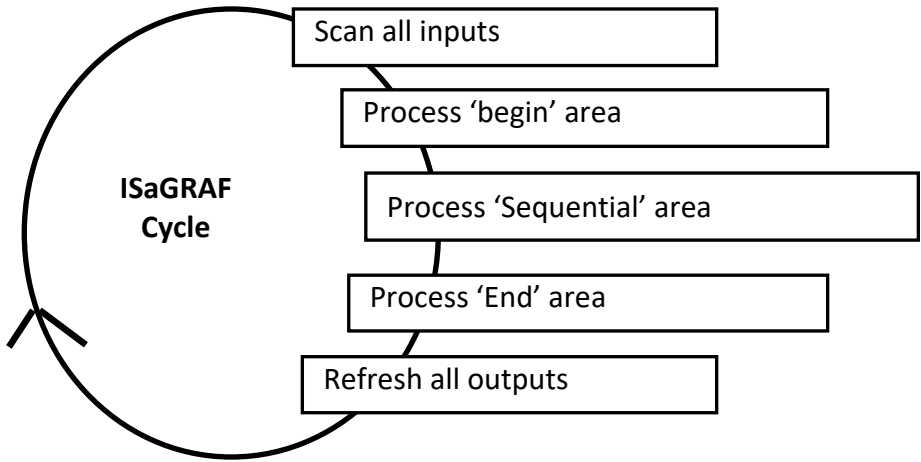

Click on the "Create New Program" icon and the "New Program" window will appear. Enter the "Name" as "LD1", next, click on the "Language" scroll button and select "Quick LD: Ladder Diagram", and make sure the "Style" is set to "Begin: Main Program". You can add any desired text to the "Comment" section for the LD program, but it isn't required.

Now we have one program inside this project. Please double click on the "LD1" to get into it.

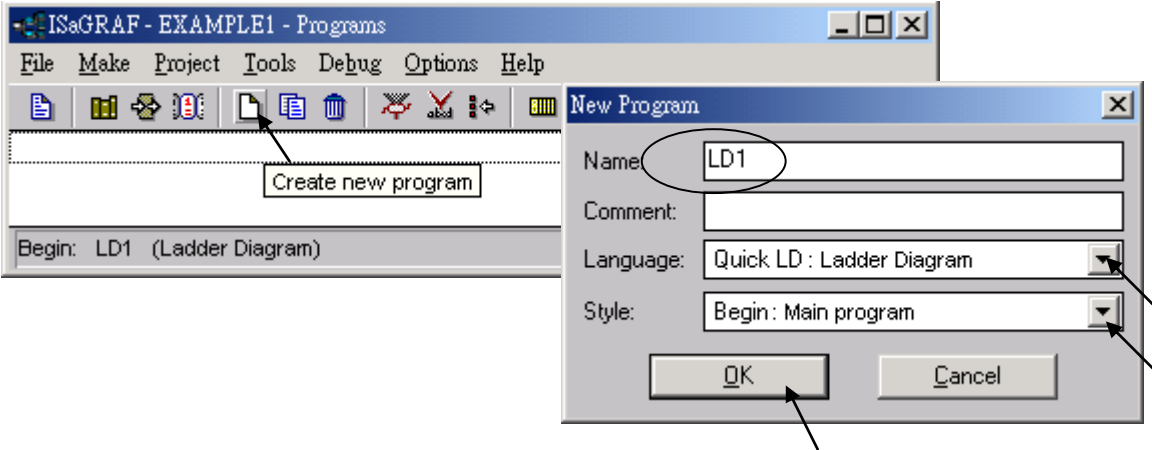
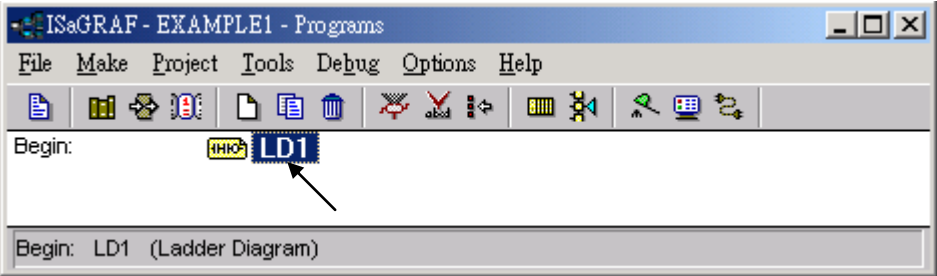

4.1.7 Edit The "LD1" Program

When you double click on the "LD1" name the "Quick LD Program" window will appear. To start programming our LD program, click on "Edit" from the main menu bar, then click on "Insert Rung". "Insert Rung" means to insert a basic LD rung just above the current position.

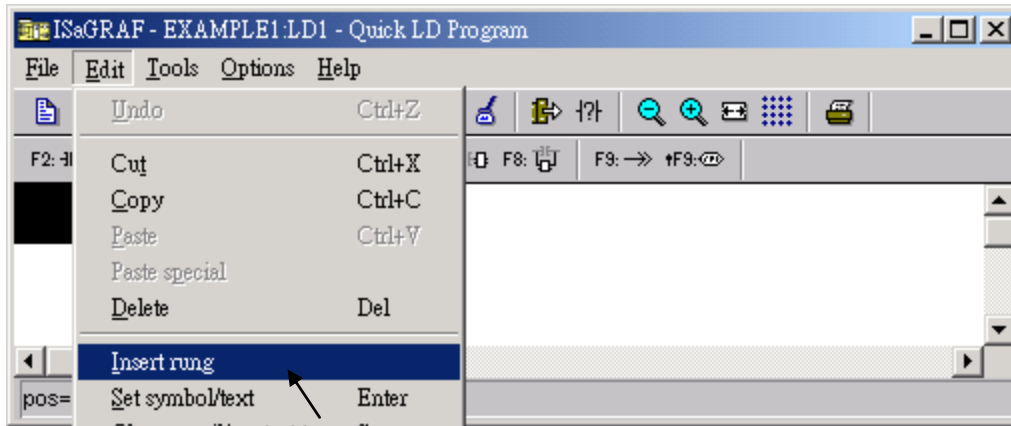

Or, you may just simply click on the "F2 (Contact On The Left)" icon, and the following will appear within the Quick LD Program window.

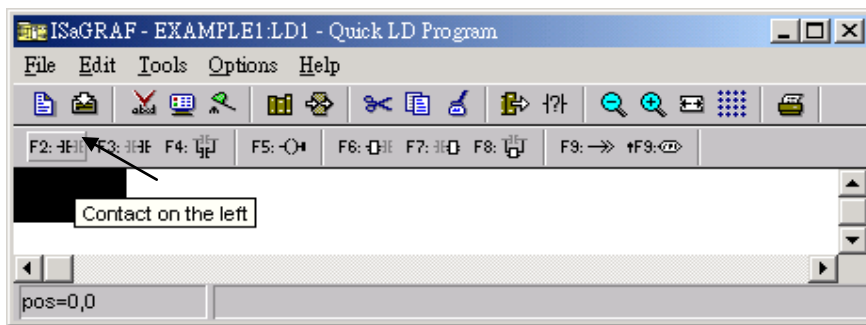

We are going to write the first line of the LD1 program. Move the cursor to the first "contact" and then click on "cut" to delete it.

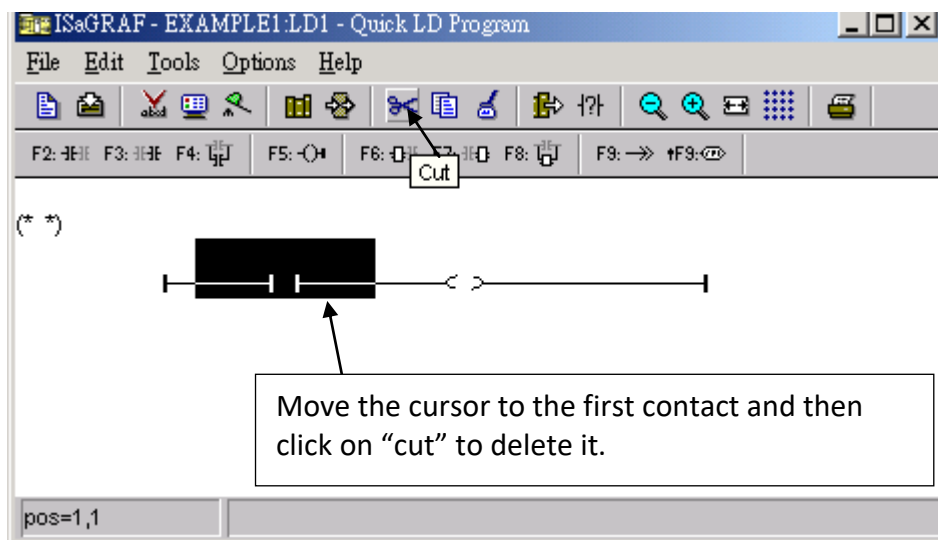

Click on the "F6 (Block on the left)" icon and you will create a block on the left of the "coil".

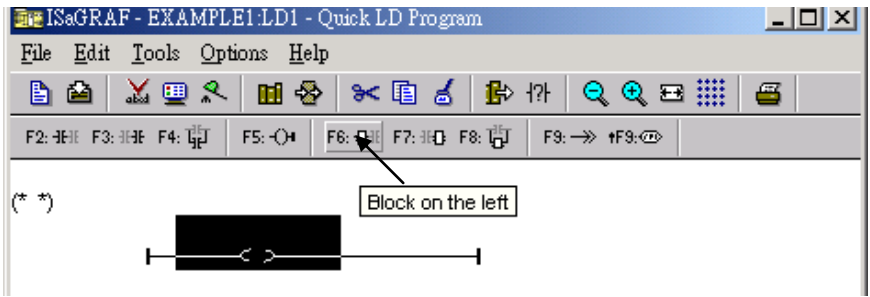

Now we are going to assign the associated variable & constant to each item. Double click anywhere inside of the block and the "Function Block" assignment window appears. Select the "BLINK" type function block. To learn how the "BLINK" function operates you can click on the "Info" button for a detailed explanation of its functionality.

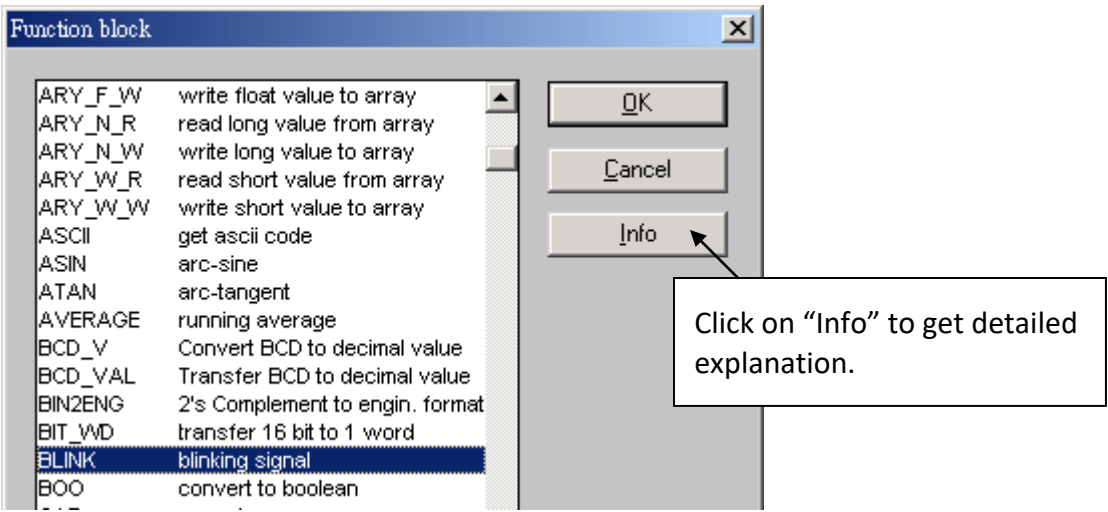
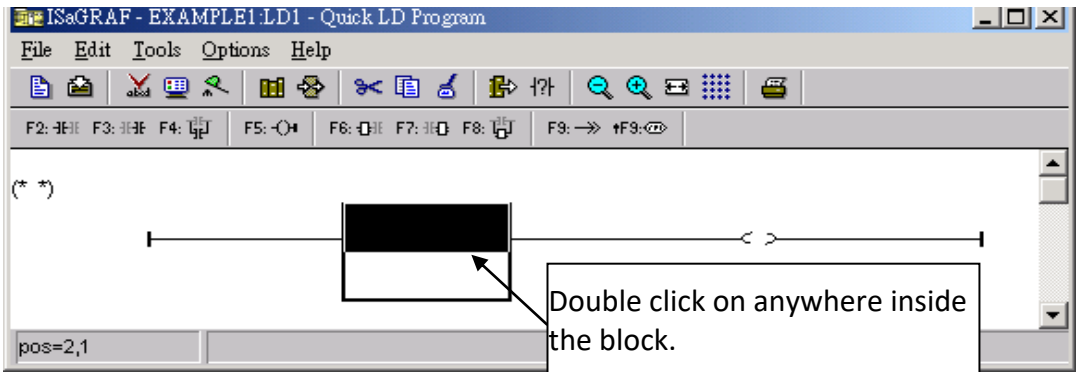

Now move your cursor to the left of the parameter "CYCLE" of the "BLINK" block. Double click on it, select "Timer" and then double click on variable name - "T1".

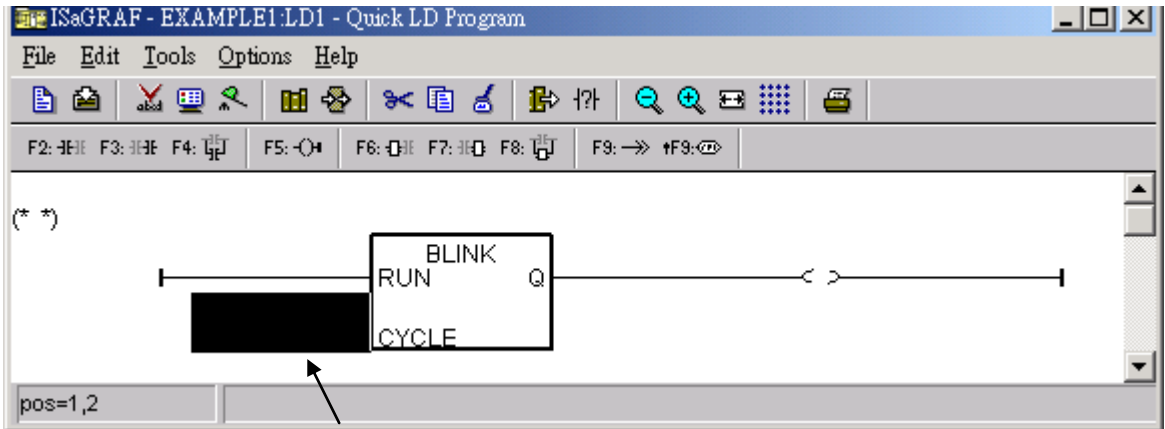

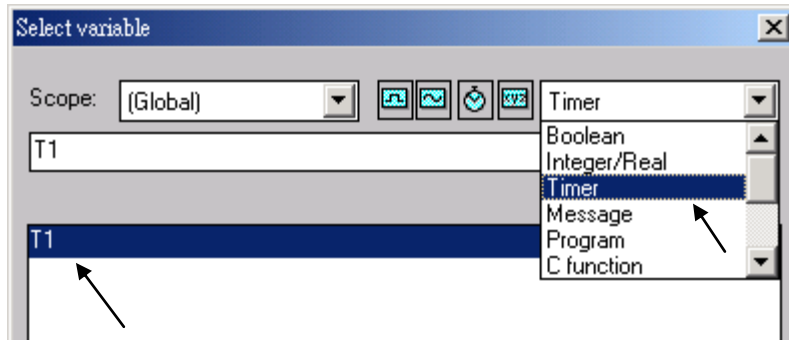

Move your cursor to the “coil”. Double click on it, select “Boolean” and then double click on variable name – “OUT01”.

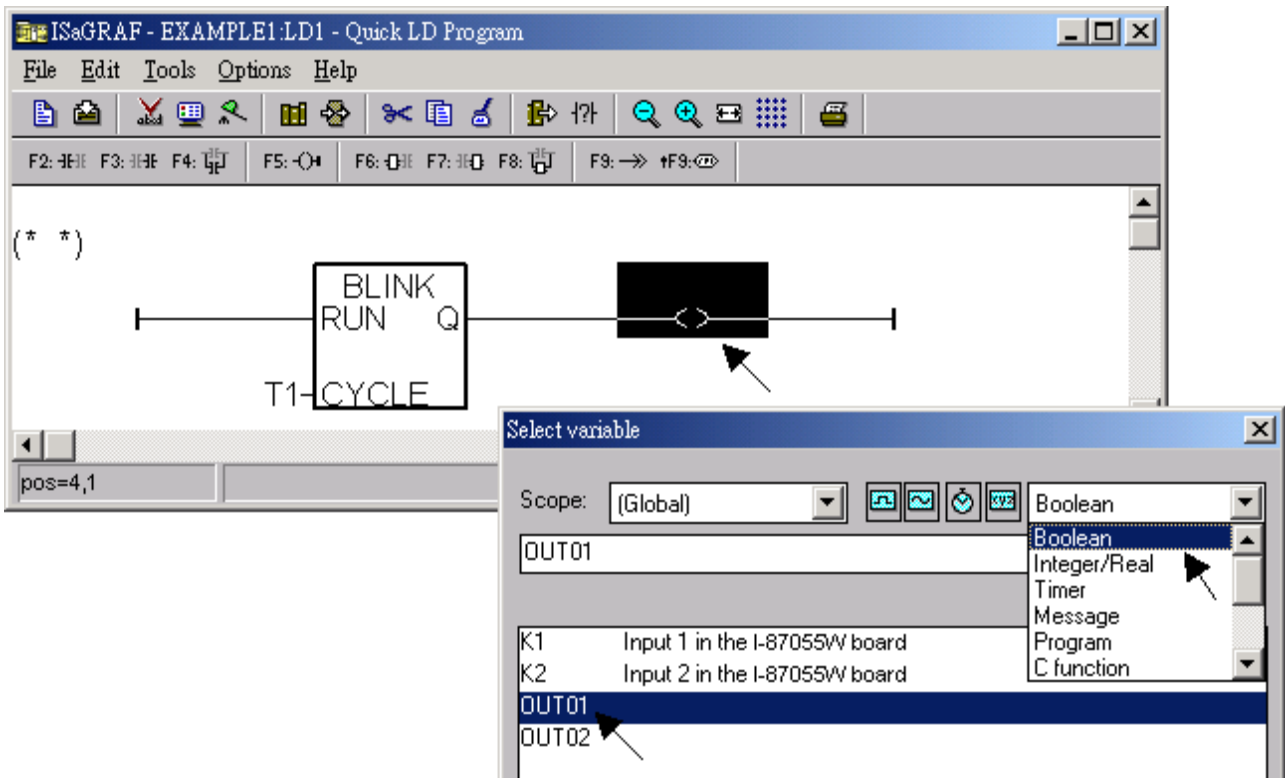

Now we have finished our Ladder code, click on “Save” and then click on “X” to exit.

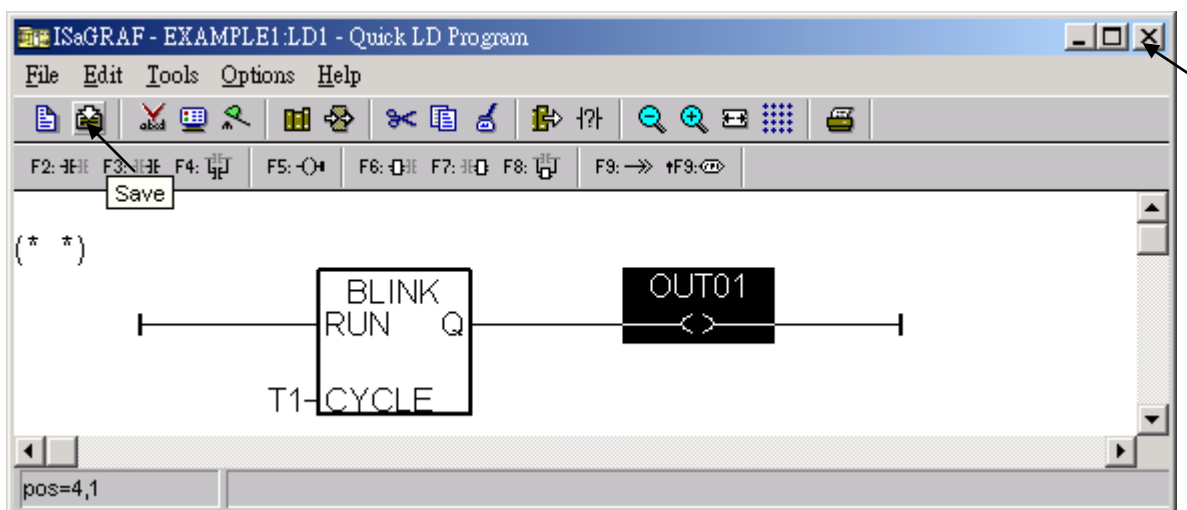

4.1.8 Connecting The I/O

We have defined variables name of “OUT01”, “OUT02” as “output” attribution, while “K1” & “K2” as “input” attribution in [step 4.1.4](#). These “input” & “output” variables should be map to physical I/O in the controller before they can work.

To do that, click on “I/O connection” to get into the I/O connection window. Double click on the No. 1 slot (Please make sure your I-87055W I/O board is plug in slot 0 of the ViewPAC) & then check on the “Equipments” & double click on the “I_87055: 8 CH. DI & 8 CH. DO”.

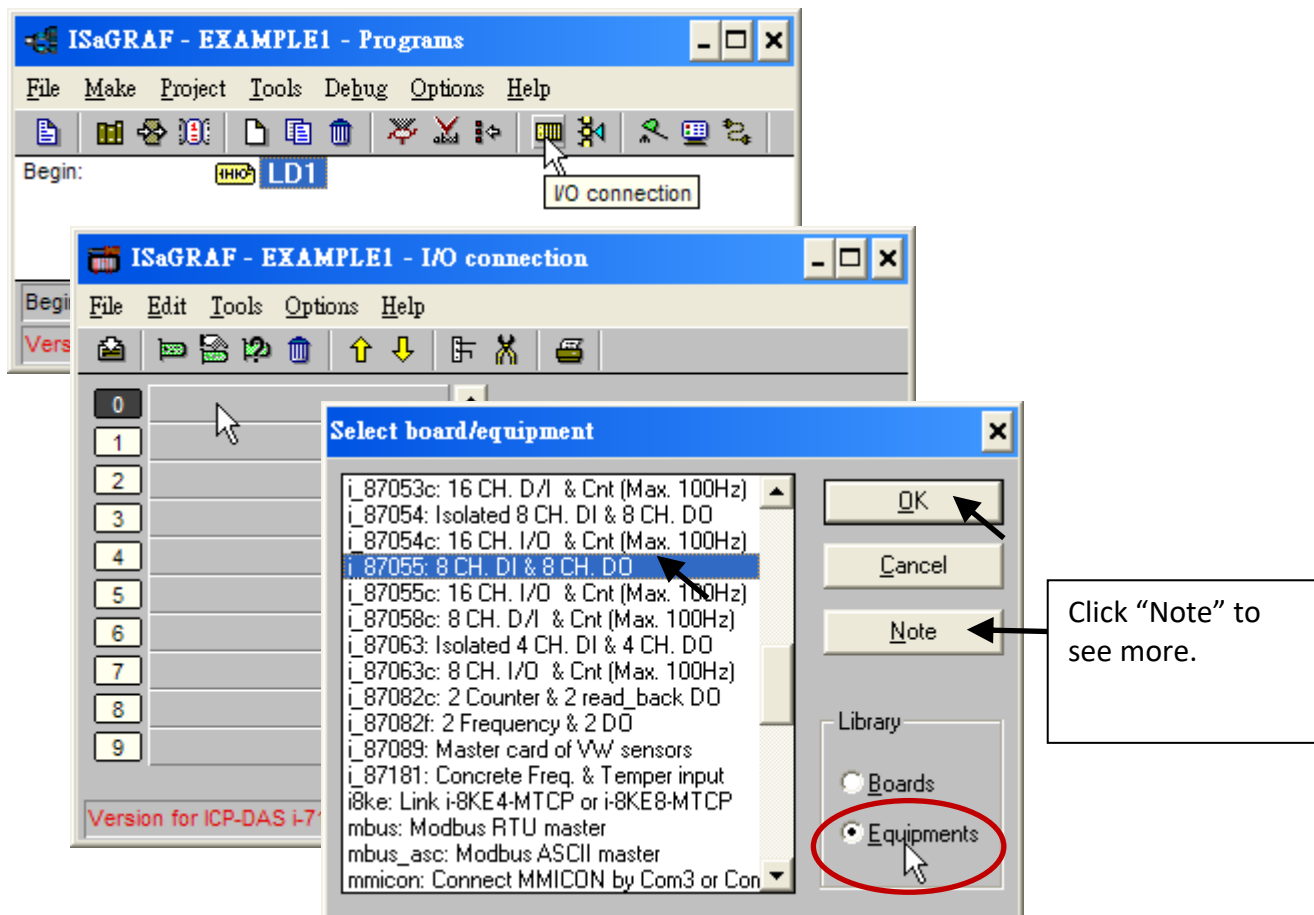

Then we have. (If you don't have the I-87055W, you may click the “Real / Virtual board” to make it become virtual board.)

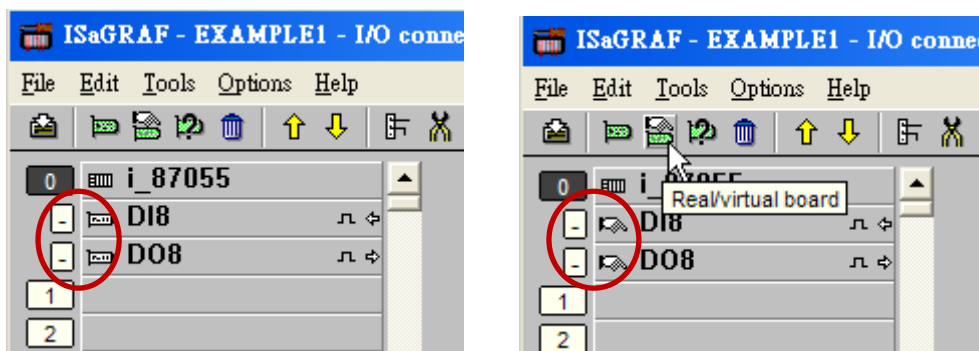

To map input variables “K1” & “K2” to the input channel No. 1 & 2 of the “I-87055”, double click on the channel 1 and then click on “Connect” .Then click on “Connect” again to connect channel 2.

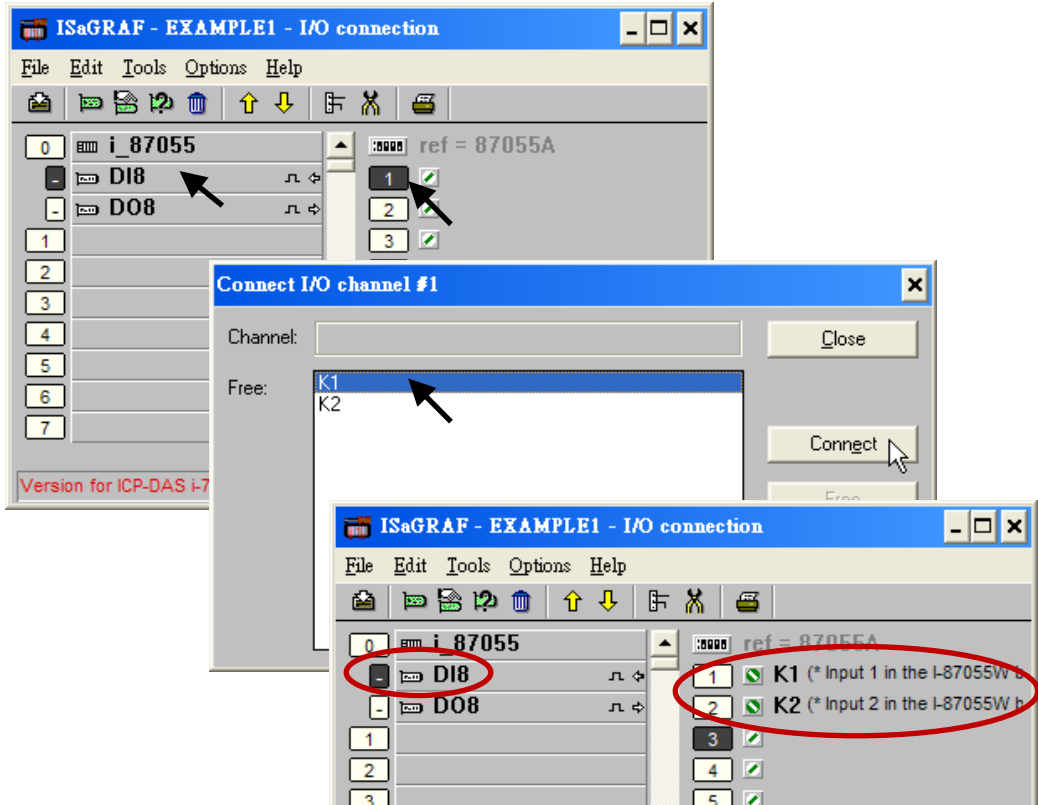

By the same way, please connect “OUT01” , “OUTPUT02” to output channel 1 to 2. Then we have below window. Click on “Save” and then exit.

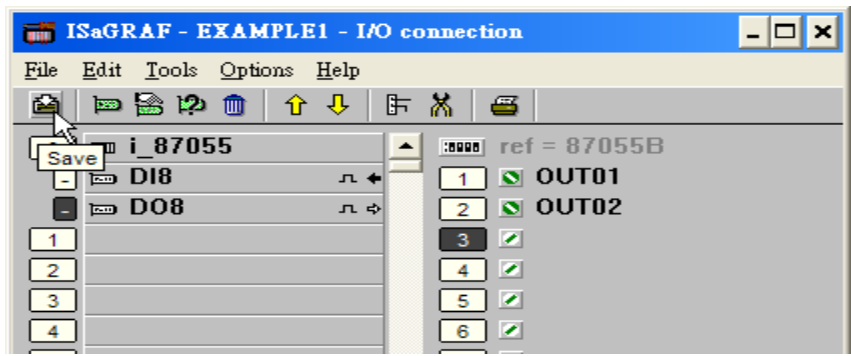

IMPORTANT NOTICE:

1. I/O Slots 0 through 7 are reserved for **REAL I/O** boards that will be used in the VP-2xW7/4xx7. You can use slot No. 8 and above for additional functionality.
2. All of the variables with “Input” and “Output” attribute **MUST** be connected through the I/O connection as described above for any program to be successfully compiled. Only the Input and Output attributed variables will appear in the "I/O Connections" window. In this example we have only 2 Boolean output variables - OUT01, OUT02 and 2 Boolean input variables – K1 & K2.

4.2 Compiling & Simulating The Example Project

For ANY AND EVERY ISaGRAF program to work properly with any of the ISaGRAF PAC (XPAC, XPAC-Atom, WinPAC, ViewPAC, μ PAC and iPAC), it is the responsibility of the programmer to properly select the correct "Compiler Options". You MUST select the "ISA86M: TIC Code For Intel" option as described below.

To begin the compilation process, first click on the "MAKE" option from the main menu bar, and then click on "Compiler Options" as shown below.

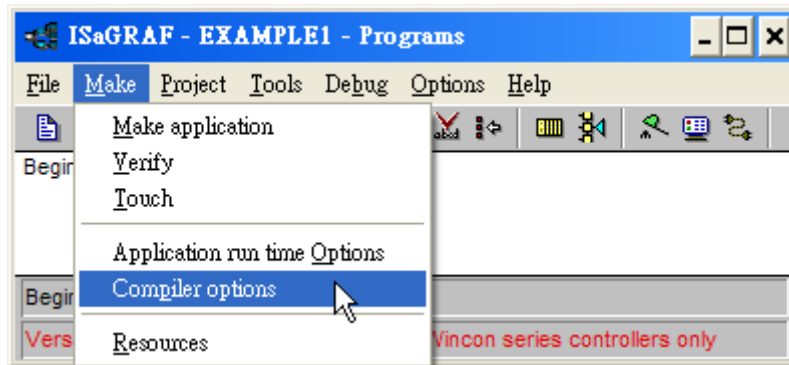

The "Compiler Options" window will now appear. Make sure to select the options as shown below then press the "OK" button to complete the compiler option selections.

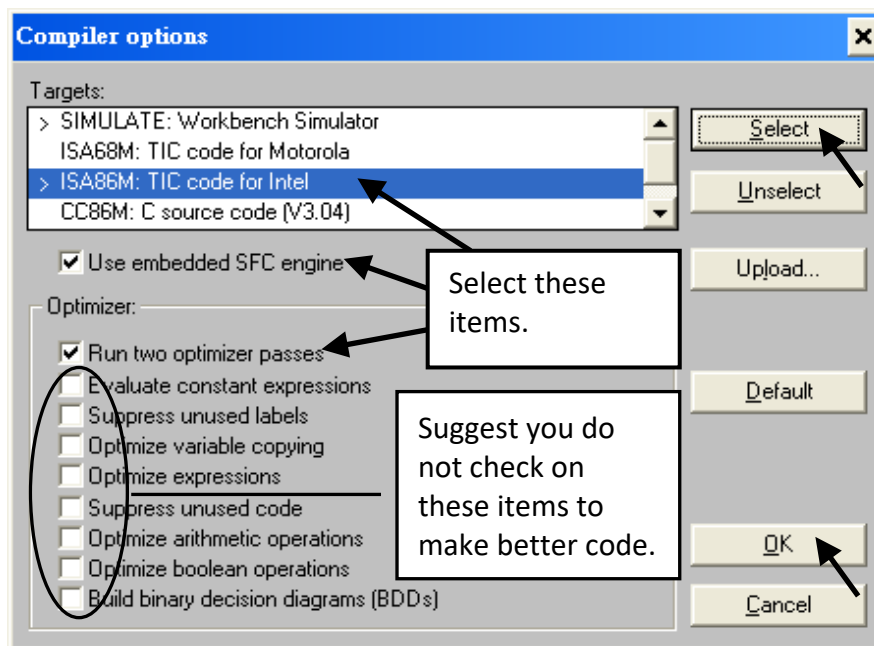

Compile the Project !

Now that you have selected the proper compiler options, click on the "Make Application Code" icon to compile the example project. If there are no compiler errors detected during the compilation process, CONGRATULATIONS, you have successfully created our example program

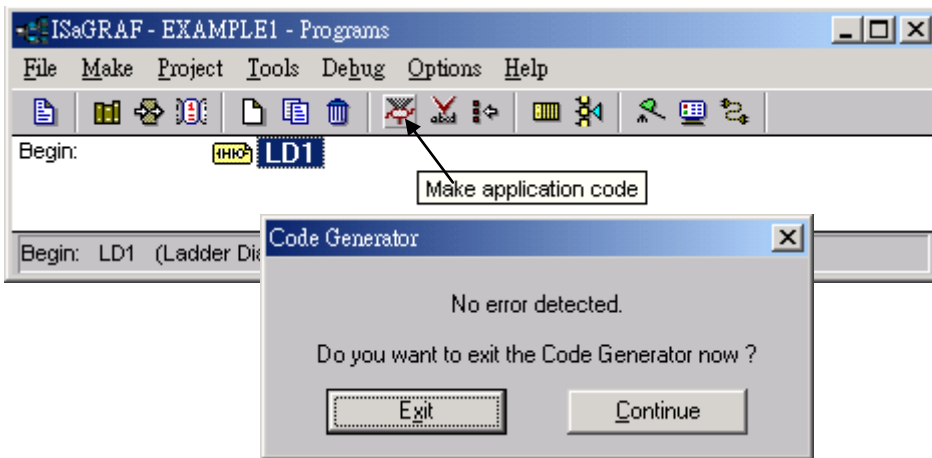

If errors are detected during the compilation process, just click on the "CONTINUE" button to review the error messages. Return to the Project Editor and correct the errors as outlined in the error message window. (Compiling Error Result In Different ISaGRAF Version, please refer to [appendix H.](#))

Simulate the Project !

If the compilation is Ok, you may simulate the project on the PC to see how the program works without the controller. To do that, click on the "Simulate" icon.

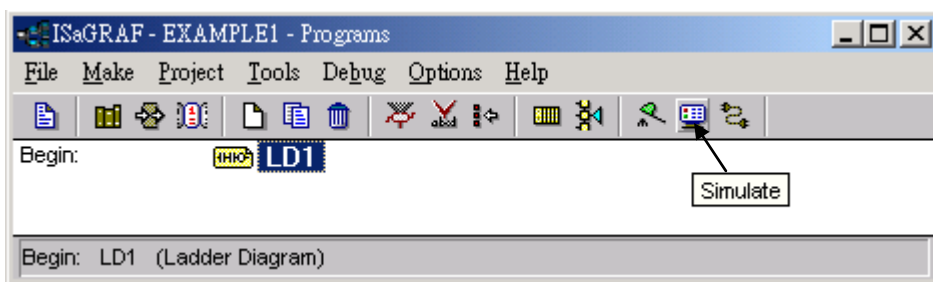

When you click on the "Simulate" icon three windows will appear. The windows are the "ISaGRAF Debugger", the "ISaGRAF Debug Programs", and the "I/O Simulator" windows. If the I/O variable names you have created DO NOT appear in the I/O simulator window, just click on the "Options" and "Variable Names" selection and the variable names you have created will now appear next to each of the I/O's in the simulator window.

In the "ISaGRAF Debug Program" window, double click on the "LD1" where the cursor below is positioned. This will open up the ISaGRAF Quick LD Program window and you can see the LD program you have created.

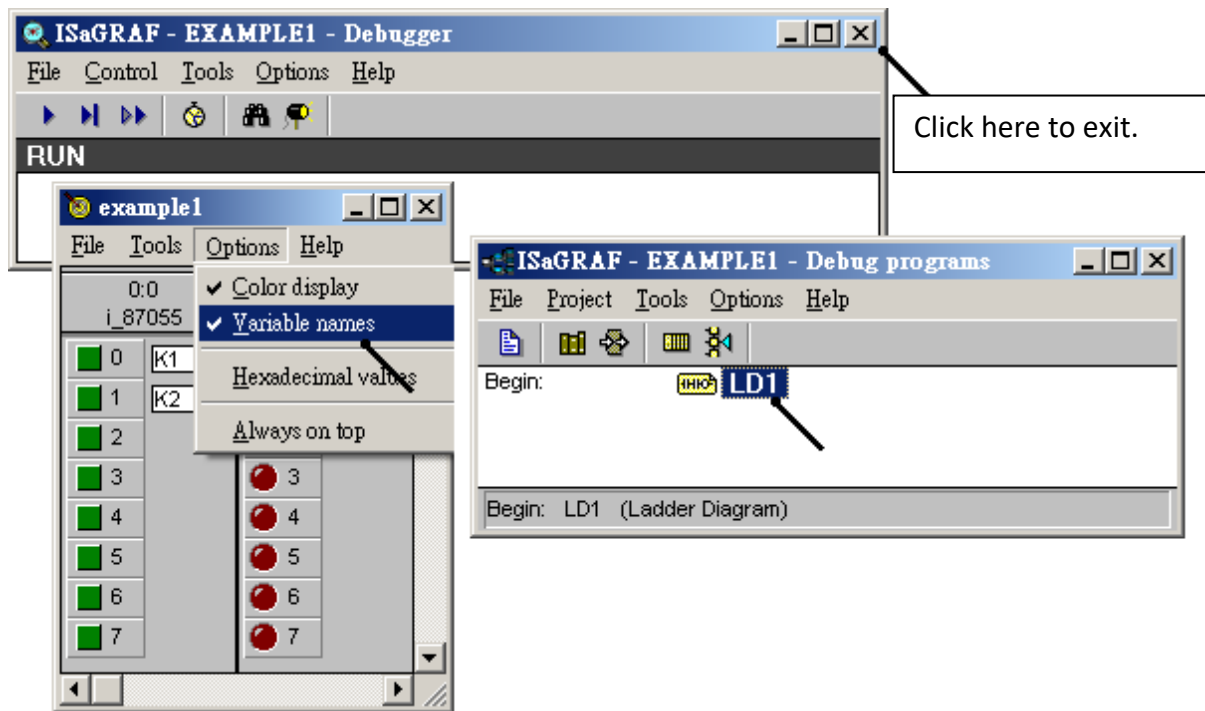

Running The Simulation Program

When you double click on "LD1" in the "ISaGRAF Debug Programs" window, the follow window should appear.

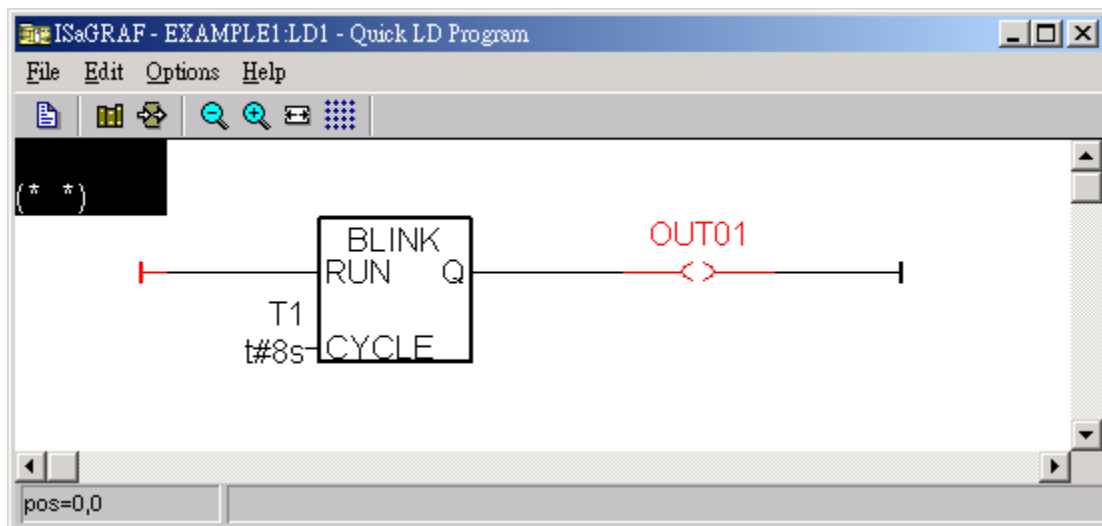

You can see outputs "OUT01" will blink in the period of 8 seconds.

You can adjust the "T1" variable while the program is running. To accomplish this, click on the "Dictionary" icon which will open the "ISaGRAF Global Variables" window as shown in the first two pictures below. Click on "Timer" tab and then double click on "T1" to change the timer value to "T#4000ms" (this means 4000 ms). Then click on "Write".

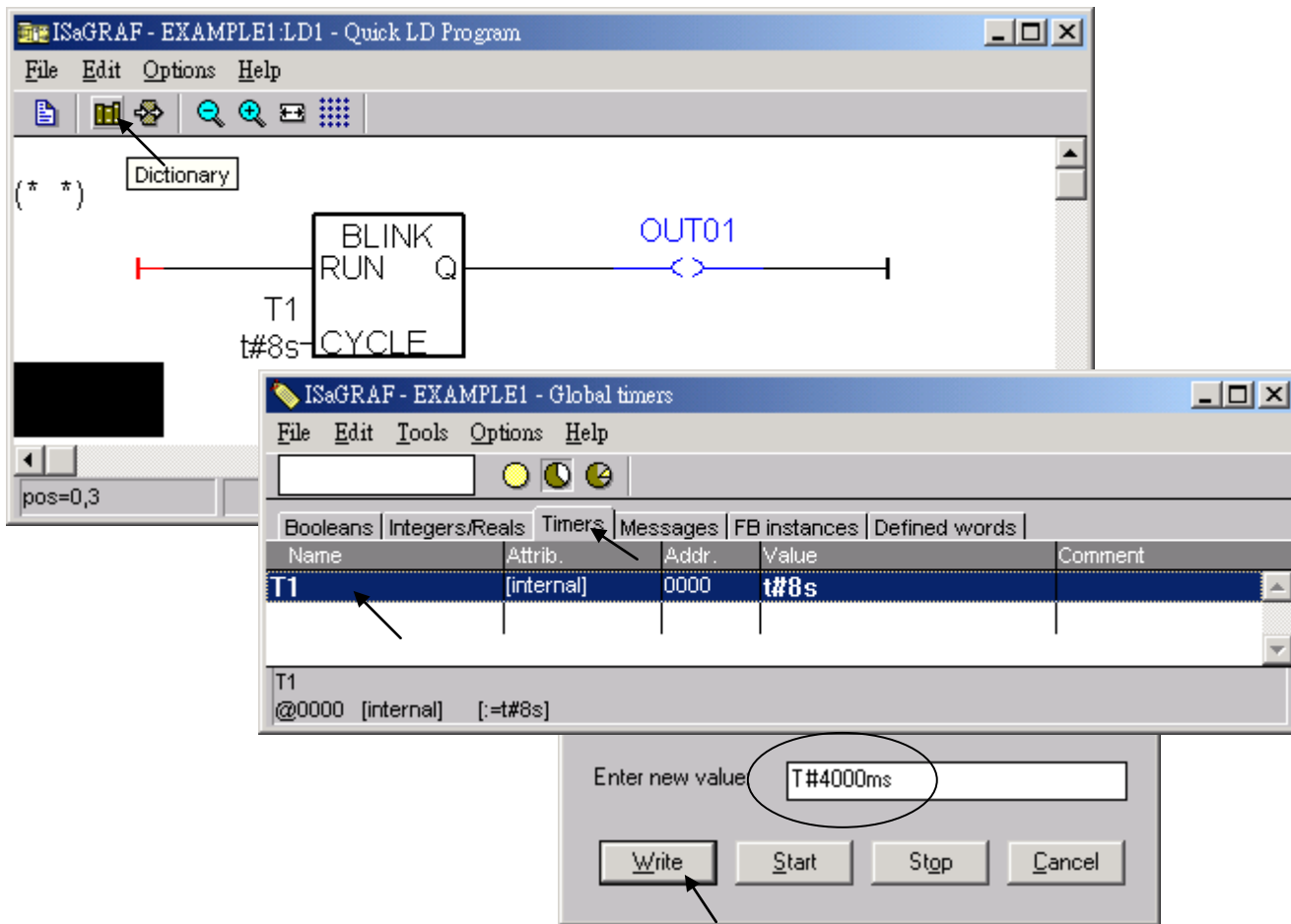

Now we are going to simulate the "K1" & "K2" input. Click on "K1" using the left button of the mouse.

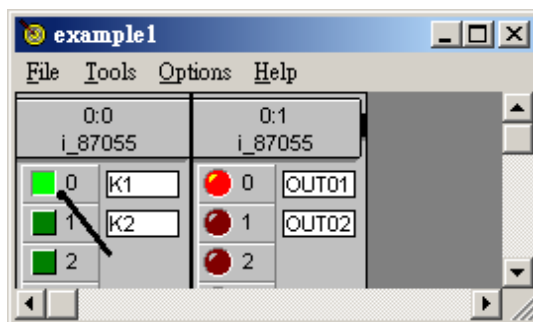

To exit simulation, please close the debugger window.

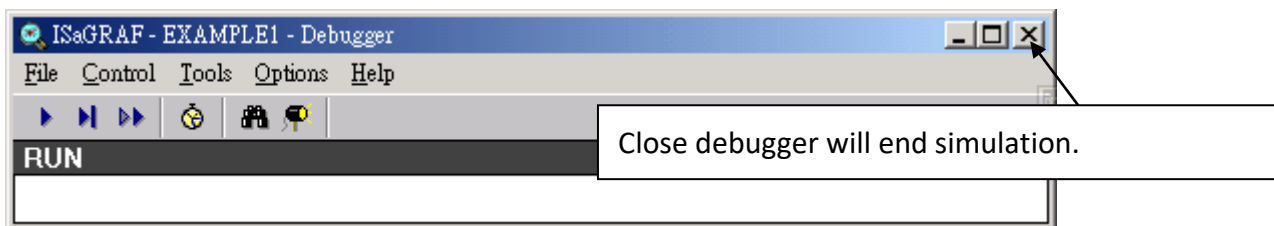

4.3 Download & Debug The Example Project

We have two ways to download the project to the ISaGRAF WinCE ViewPAC. One is using Ethernet cable, the other one is using RS-232 cable. Here will show you the RS-232 way. (Please refer to [section 3.2.3](#) if you would like to download the project via Ethernet)

Hardware Wiring

The RS-232 cable wiring should be as below figure. (Please make sure the "Modbus RTU Slave Port" is set as COM3 (refer to [Appendix A.2](#), or it can only be download via Ethernet)

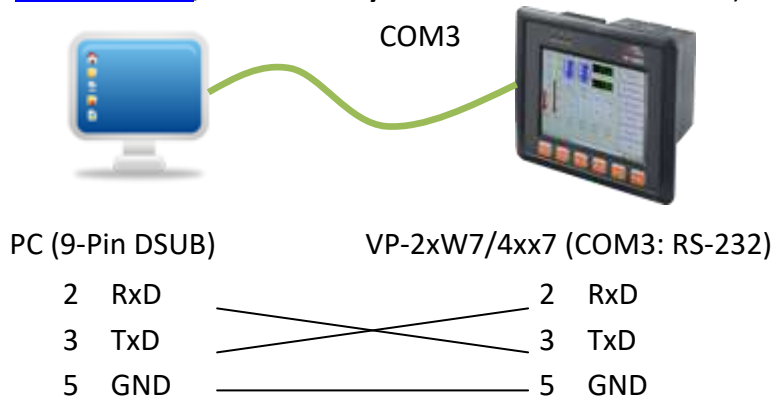

This section lists how to download the ISaGRAF program via RS-232 cable. However user may also use Ethernet cable to download program to the VP-2xW7/4xx7 (please refer to [section 3.2.3](#))

Link Setup

Click on the "Link Setup" icon in the "ISaGRAF Programs" window. When you click on the "Link Setup" icon, the following window will appear. Please set the proper value.

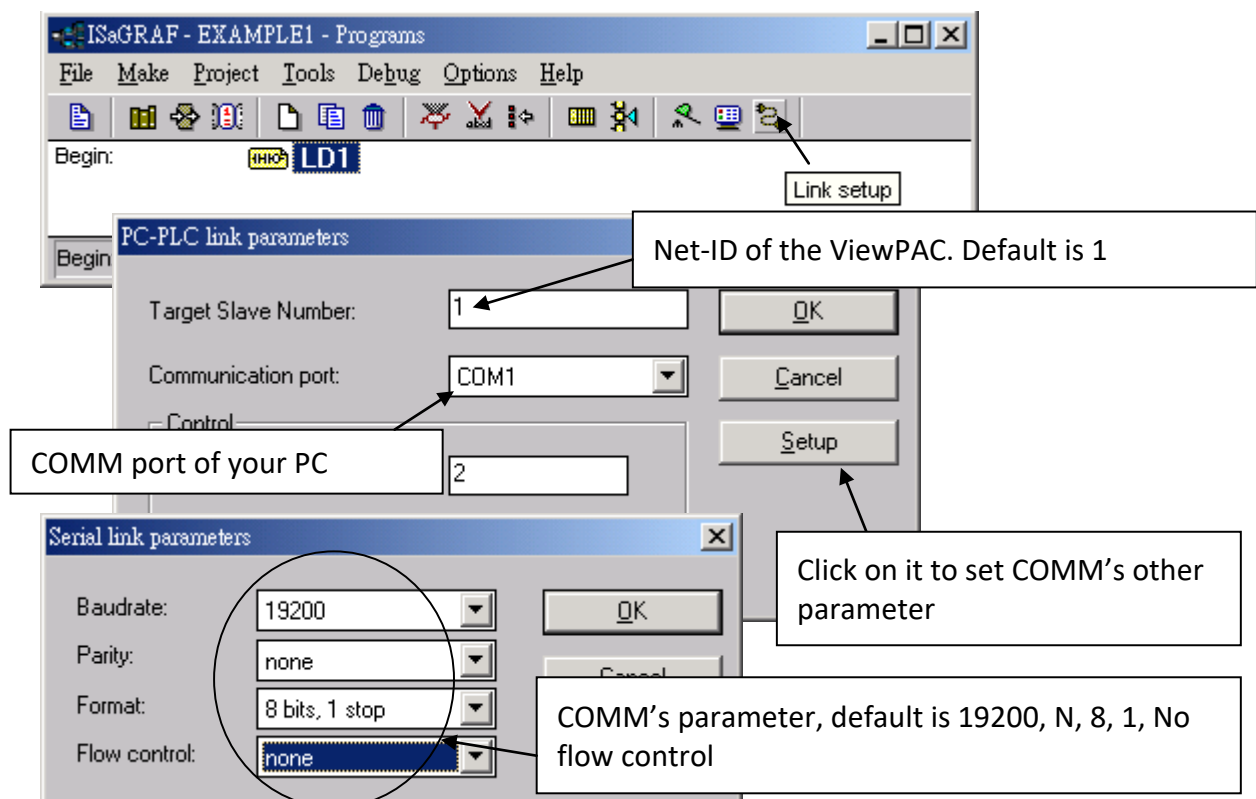

The RS-232 communication parameters for the ISaGRAF WinCE ViewPAC **MUST** be set to the same serial communication parameters for the development PC. For the ISaGRAF WinCE ViewPAC (serial port communications), the default parameters for COM3 (RS-232) port are:

Baudrate:	19200
Parity:	none
Format:	8 bits, 1 stop
Flow control:	none

(Please refer to [Appendix A.2](#) to setup COM3 as Modbus RTU slave port)

Debug the Link

Before you can download the project to the PAC, you must first verify that your PC and the PAC system are communicating with each other. To verify proper communication, click on the "Debug" icon in the "ISaGRAF Programs" window as shown below.

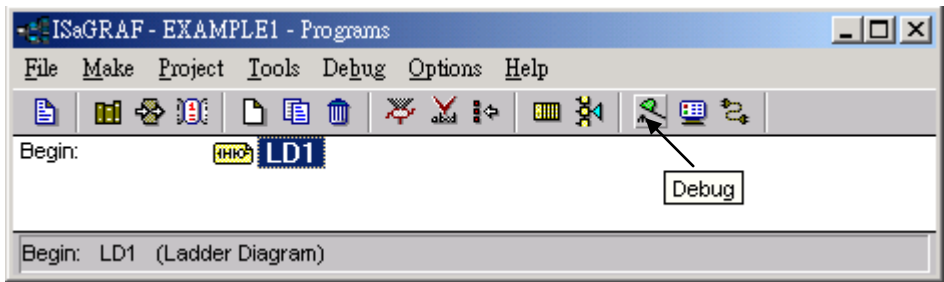

If the development PC and the PAC system are communicating properly with each other, the following window displayed below will appear (or if a program is already loaded in the controller system, the name of the project will be displayed with the word "active" following it).

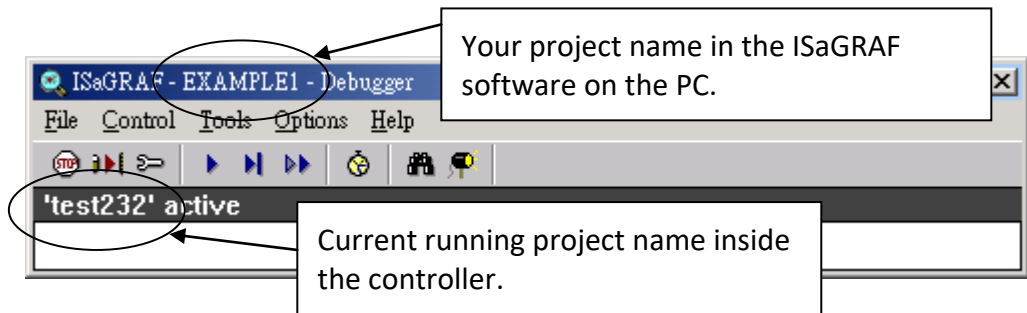

If the message in the "ISaGRAF Debugger" says "Disconnected", it means that the development PC and the controller system have not established communications with each other. The most common causes for this problem is either the serial port cable not being properly configured, or the development PC's serial port communications **DO NOT** match that of the ViewPAC system.

You may have to either change the serial port communication settings for the development PC (which may require changing a BIOS setting) or change the "Serial Link Parameters" in the ISaGRAF program.

If there is a project already loaded in the PAC system you will need to stop that project before you can download the example project. Click on the "STOP" icon to halt any applications that may be running.

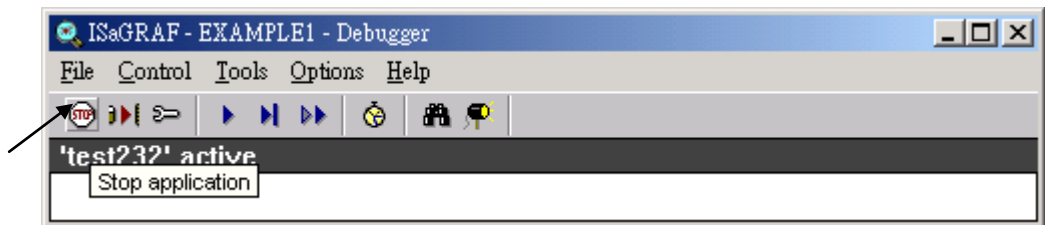

Starting the Downloading Process

From the "ISaGRAF Debugger" window click on the "Download" icon, then click on "ISA86M: TIC Code For Intel" from the "Download" window as shown below.

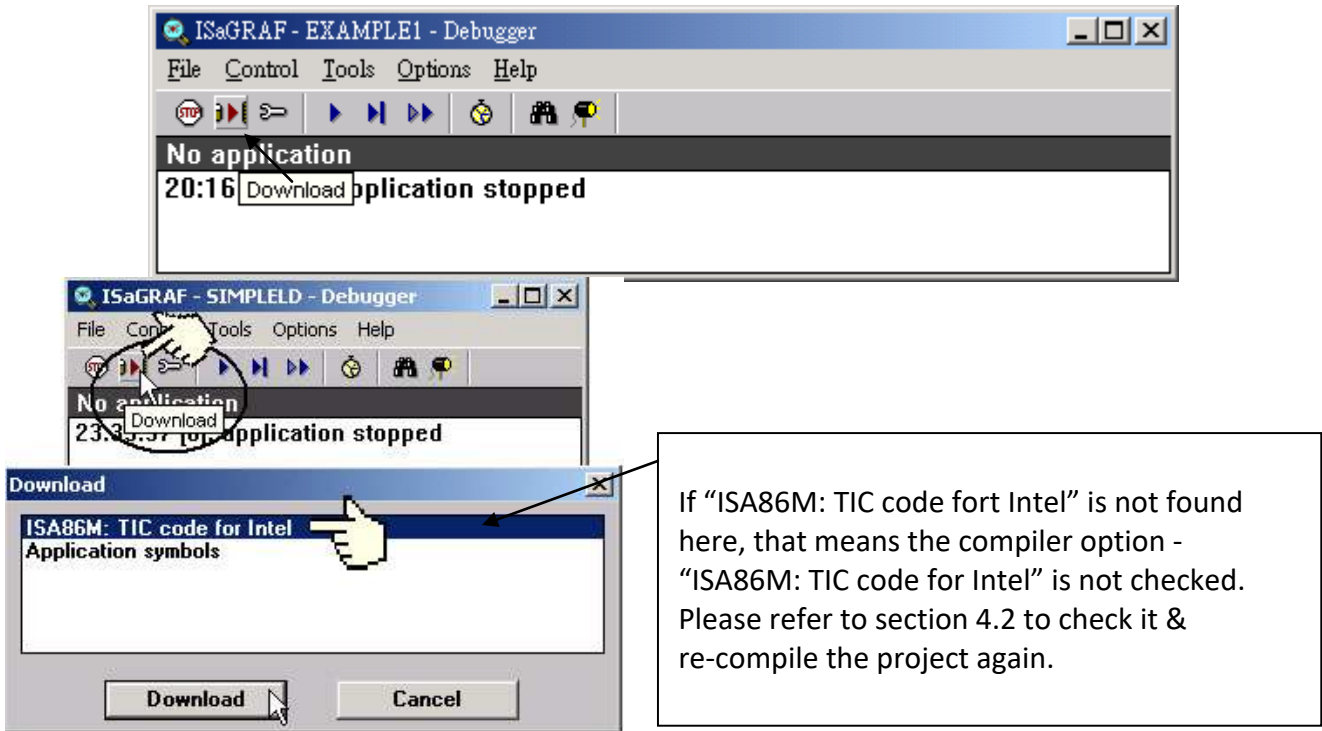

The example project will now start downloading to the VP-25W7/VP-23W7 controller system. A progress bar will appear in the "ISaGRAF Debugger" window showing the project downloading progress.



When the example project has successfully completed the downloading process to the ViewPAC controller system the following two windows will appear.

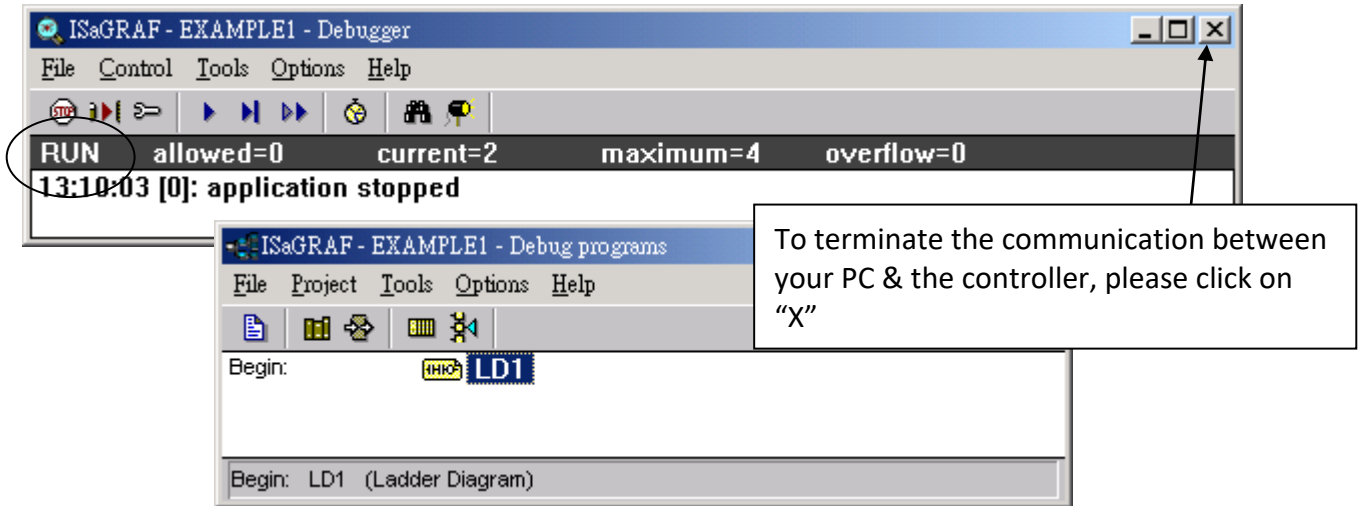

Running the Example LD Program

You can observe the real time I/O status from several ISaGRAF windows while you are running the example project. One of the windows is the "I/O Connections" window, which shows each of the inputs and outputs as assigned. Click on the "I/O Connections" icon in the ISaGRAF Debugger window to open the "I/O Connections" screen. You may switch ON/OFF the D/I on the front panel of the I-87055W I/O board to see what happens about "K1" & "K2"

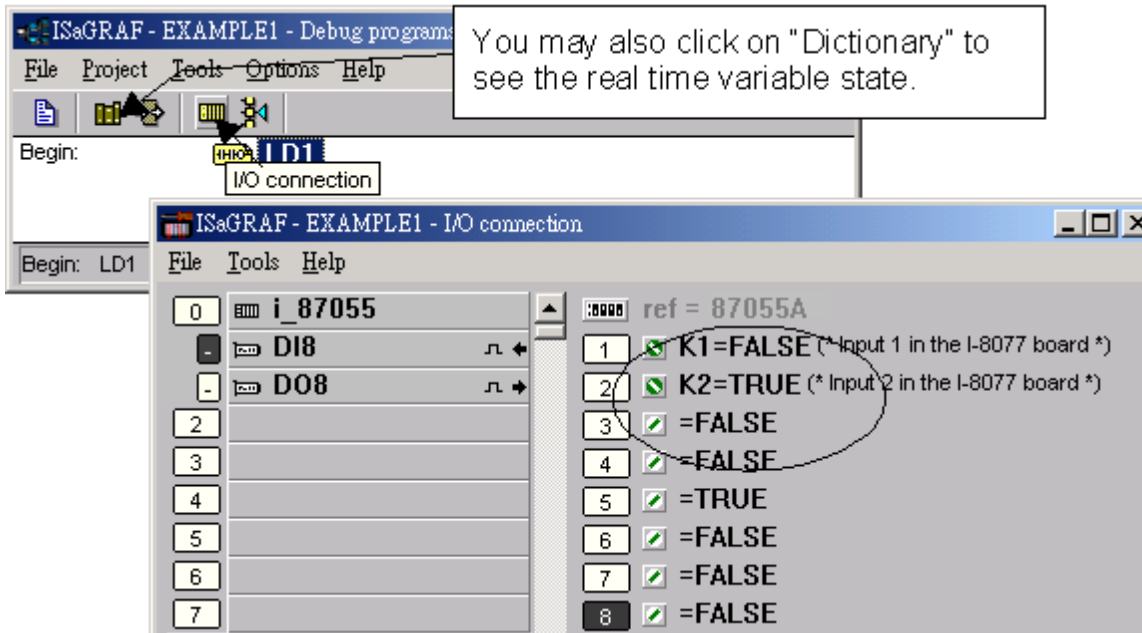

Another VERY helpful window you can open is the "Quick LD Program" window. From this window you can observe the LD program being executed in real time.

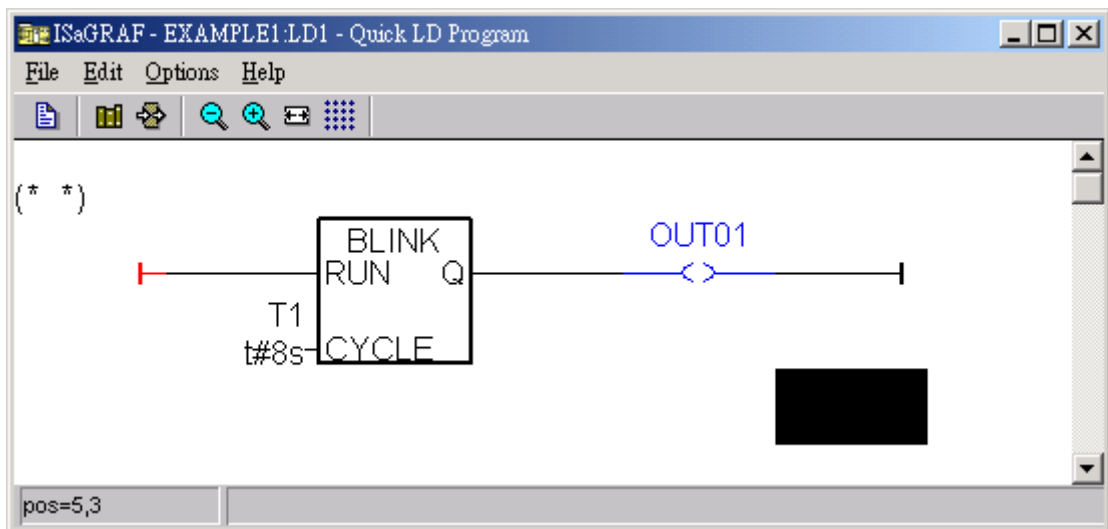
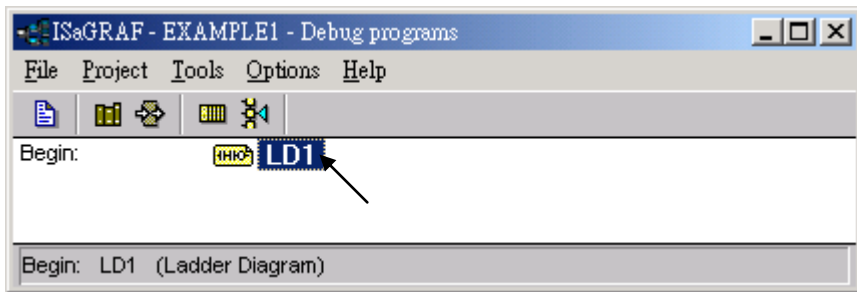

4.4 Design The Web Page

After finishing the ISaGRAF project & download it to the ISaGRAF WinCE ViewPAC, we are going to design the Web Page for this ISaGRAF project.

If you haven't practiced "[Chapter 3: Setting Up A Web HMI Demo](#)" listed in the, it's better to do it once to get familiar with it.

We will use "**Microsoft Office FrontPage 2003**" (or advanced version) to build web pages in this manual. User may choose your prefer web page editor to do the same thing.

You may refer to the finished web pages of this example in the ISaGRAF WinCE ViewPAC CD-ROM at design time. However it is better to do it one time by yourself to get more understanding.

ISaGRAF WinCE ViewPAC CD: \napdos\isagraf\vp-25w7-23w7\wp-webhmi-demo\example1\

4.4.1 Step 1 – Copy The Sample Web HMI pages

These is a sample Web HMI pages in the ISaGRAF WinCE ViewPAC CD-ROM:

\napdos\isagraf\vp-25w7-23w7\wp-webhmi-demo\sample\

Please copy this "sample" folder to your drive and rename it, for example, "**example1**".

The basic Web HMI files include 2 folders and 3 DLL files and 4 htm files as below.

Folders		
1	./img/	(default image files - *.jpg , *.bmp , *.gif)
2	./msg/	(default message files – wincon.js & xxerror.htm)
DLL Files		
1	whmi_filter.dll	(three DLL files)
2	login.dll	
3	main.dll	
HTM Files		
1	index.htm	(first default page)
2	login.htm	(the Web HMI welcome page)
3	menu.htm	(the page-menu page, normally on the left on the Internet Explorer)
4	main.htm	(first page when successfully login)

- User may put his own image files into the folder named as "user_img". And put user-defined JavaScript file or css file into the folder named as "user_msg". Other folder name is not acceptable by the ISaGRAF ViewPAC Web HMI.
- The "**index.htm**" file is the default entry page of the web server. User should not modify it. The "index.htm" re-directs to the "login.htm" file in 1 to 2 second if someone visits the ISaGRAF PAC via the Internet Explorer.
- User may modify the "login.htm" , "menu.htm" & "main.htm" to fit his own need. We will only modify the "main.htm" in this example.

4.4.2 Step 2 – Building The Main.htm

Please run the Microsoft Office FrontPage 2003 (or advanced version) and open the “main.htm”.

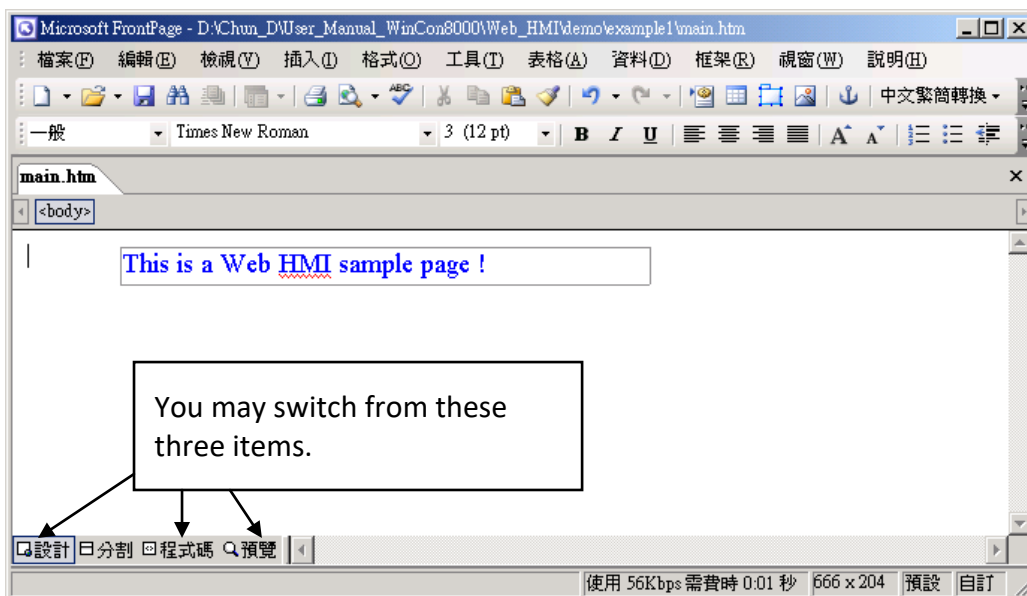

Please switch the window to design the page.

Please insert a layout object – “Layer” as below.

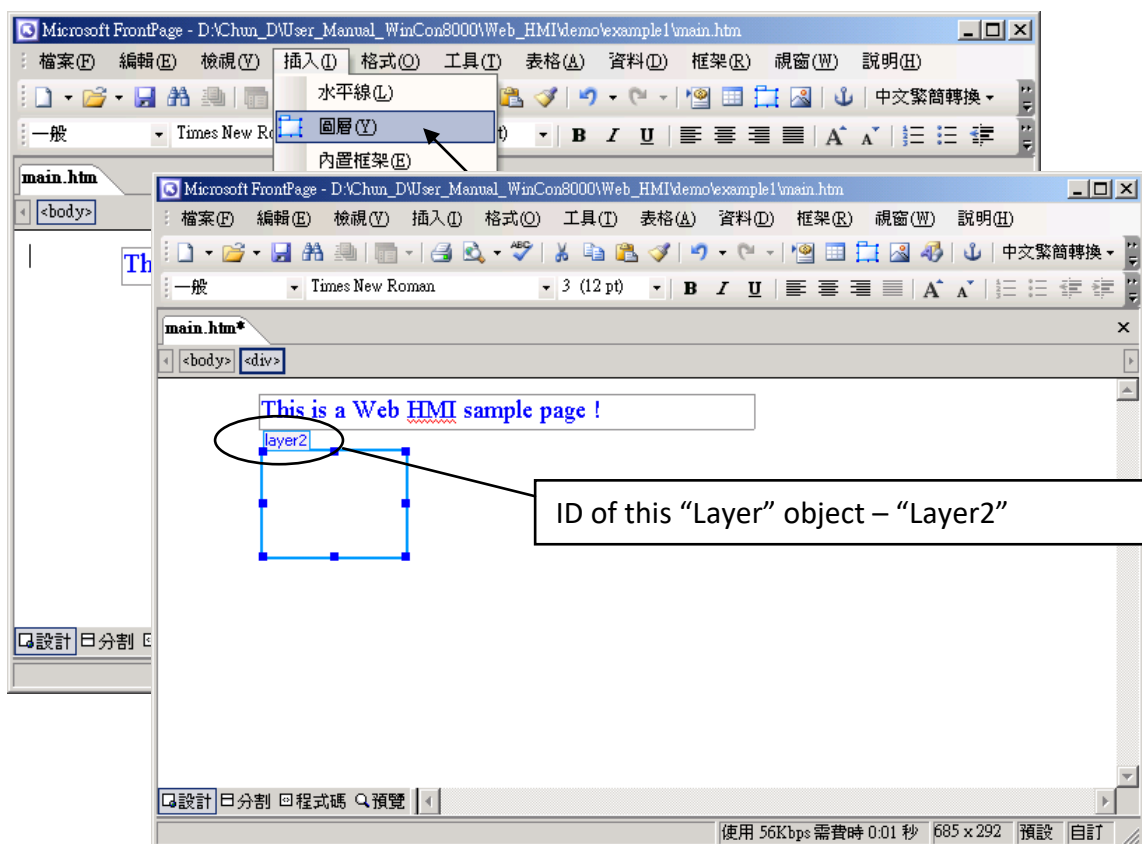

Click inside this “Layer” and then insert one another layer inside it as below. Please enter “K1” into the new created “Layer”.

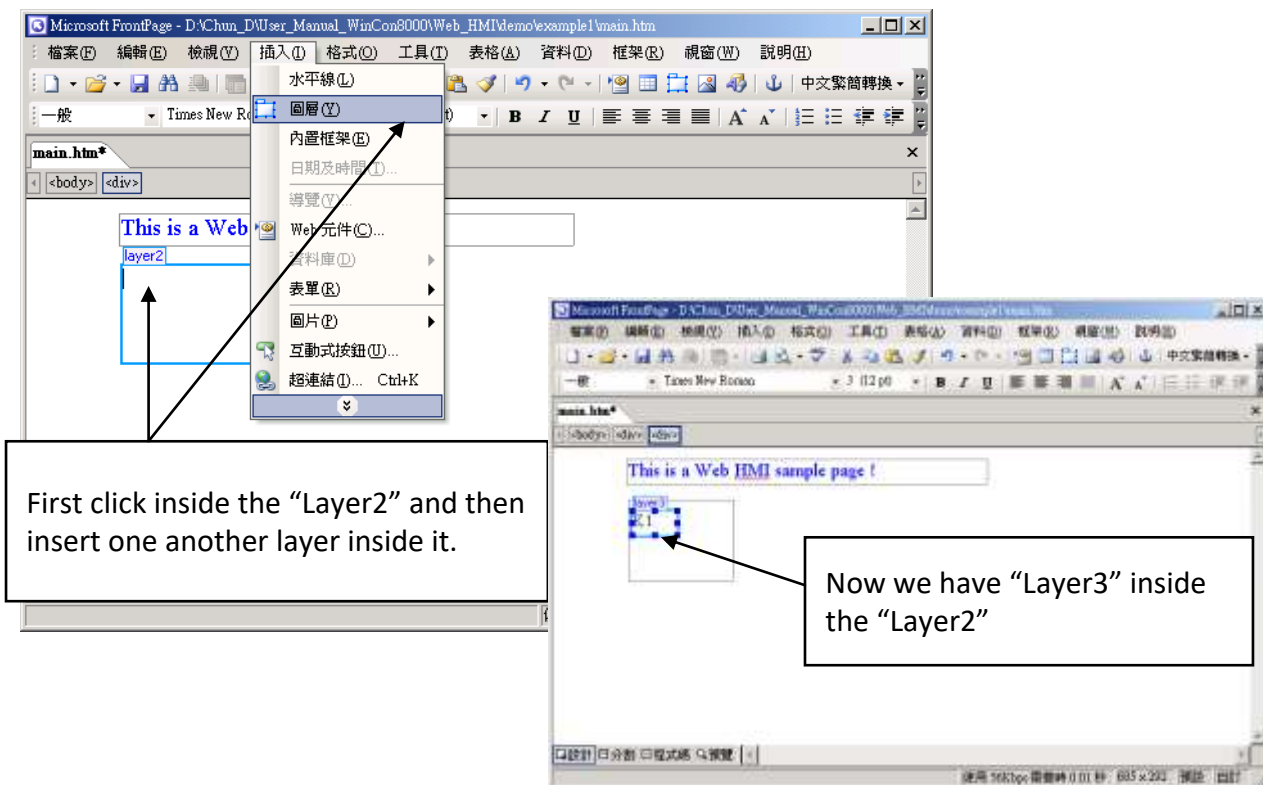

Follow the same former steps to insert one another “Layer” to be in just below the “Layer3” as below.

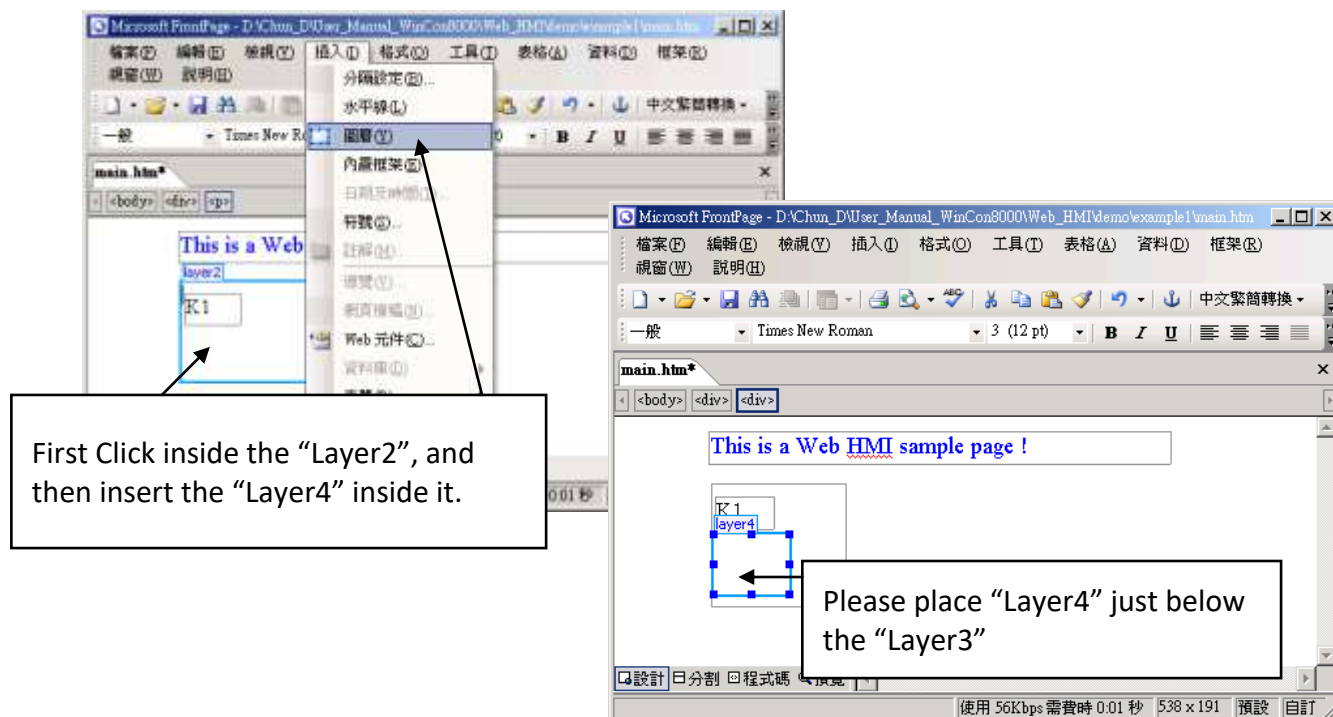

Inside the "Layer4", we are going to insert one image file to it as below. The image file name is `./img/big_Tcircle_red0.jpg`. Please browse to the correct folder in your hard driver. Here we use "example1/img/" in this example.

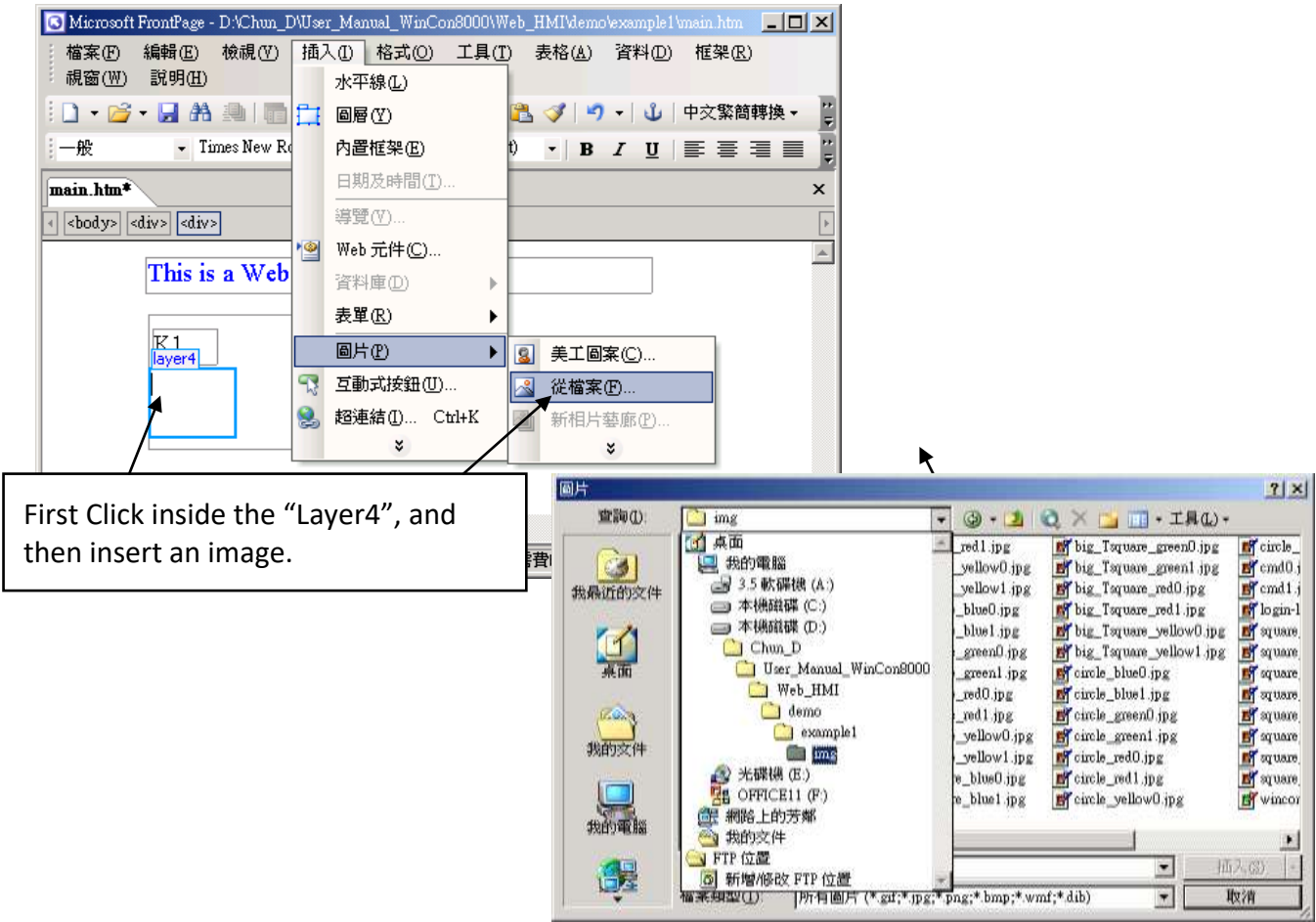

You will see a window as below.

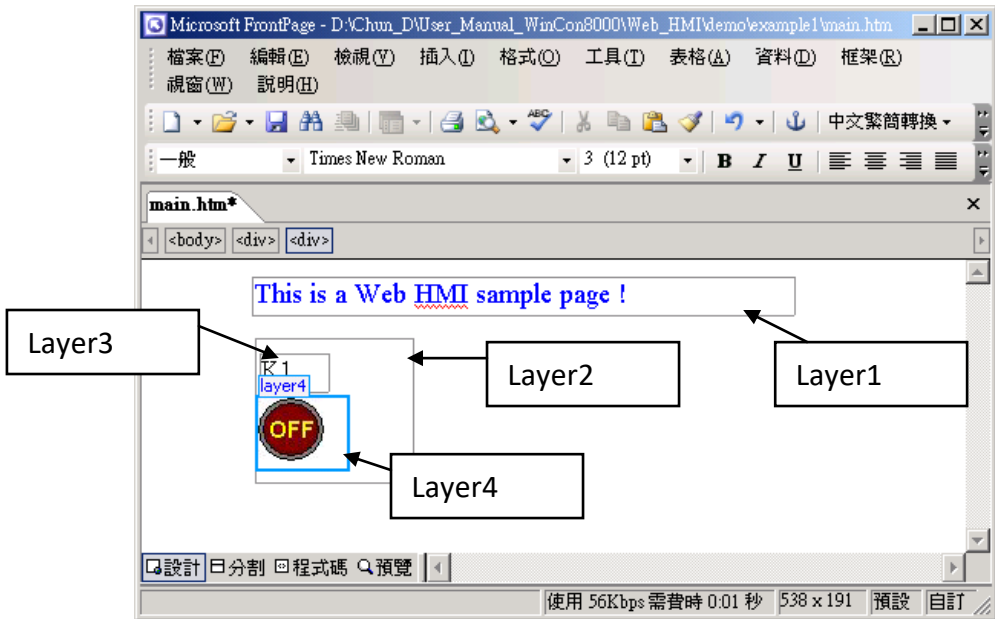

Please follow the similar steps to insert one another “Layer5” and one “Layer6” with a “K2” symbol inside it, and also a “Layer7” with a “OK” symbol inside it as below.

We will use “K1” to display the state of the first input of the I-87055W board, and “K2” for its second input.

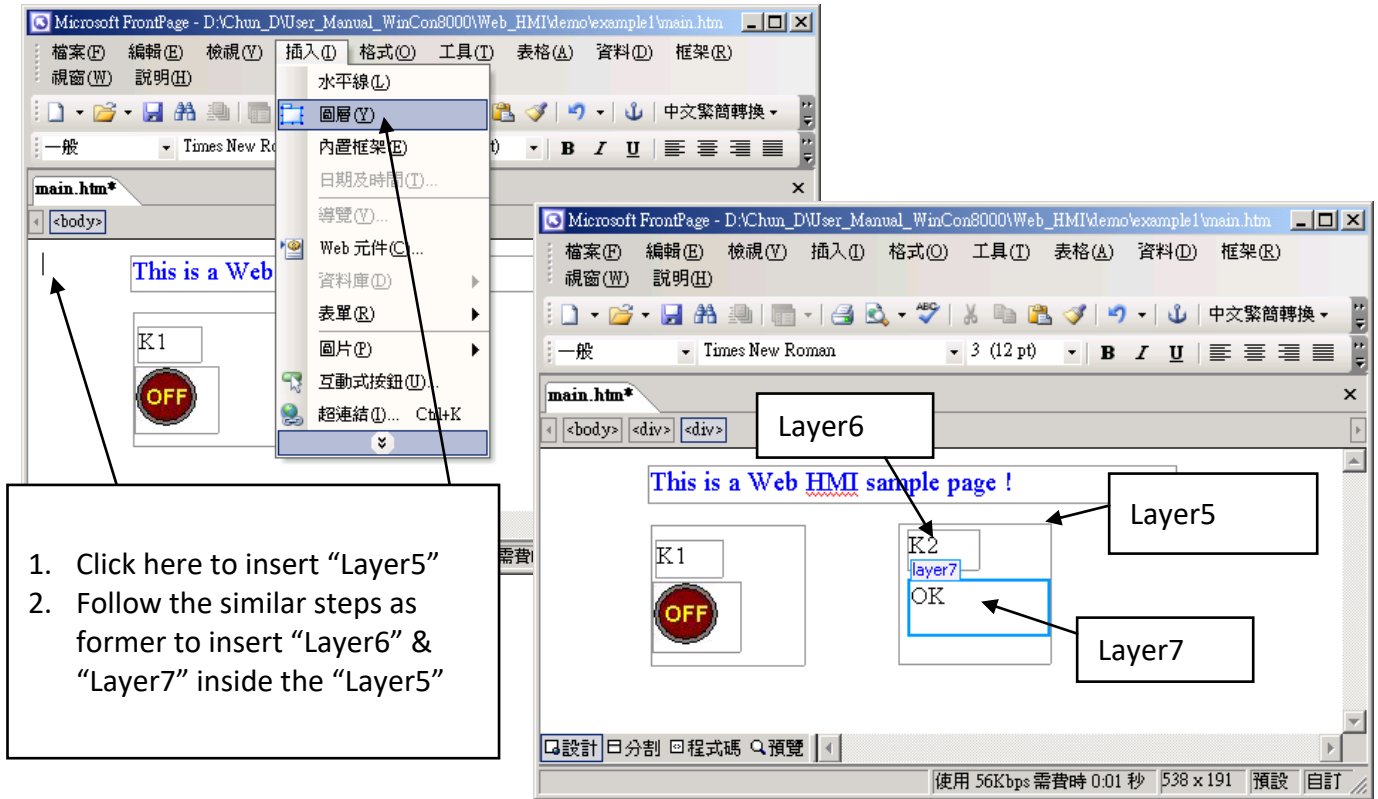

Please follow the similar steps to insert “OUT01” & “OUT02” as below. The OUT01 uses “./img/circle_blue0.jpg” as its image source, while OUT02 using “./img/cmd0.jpg”.

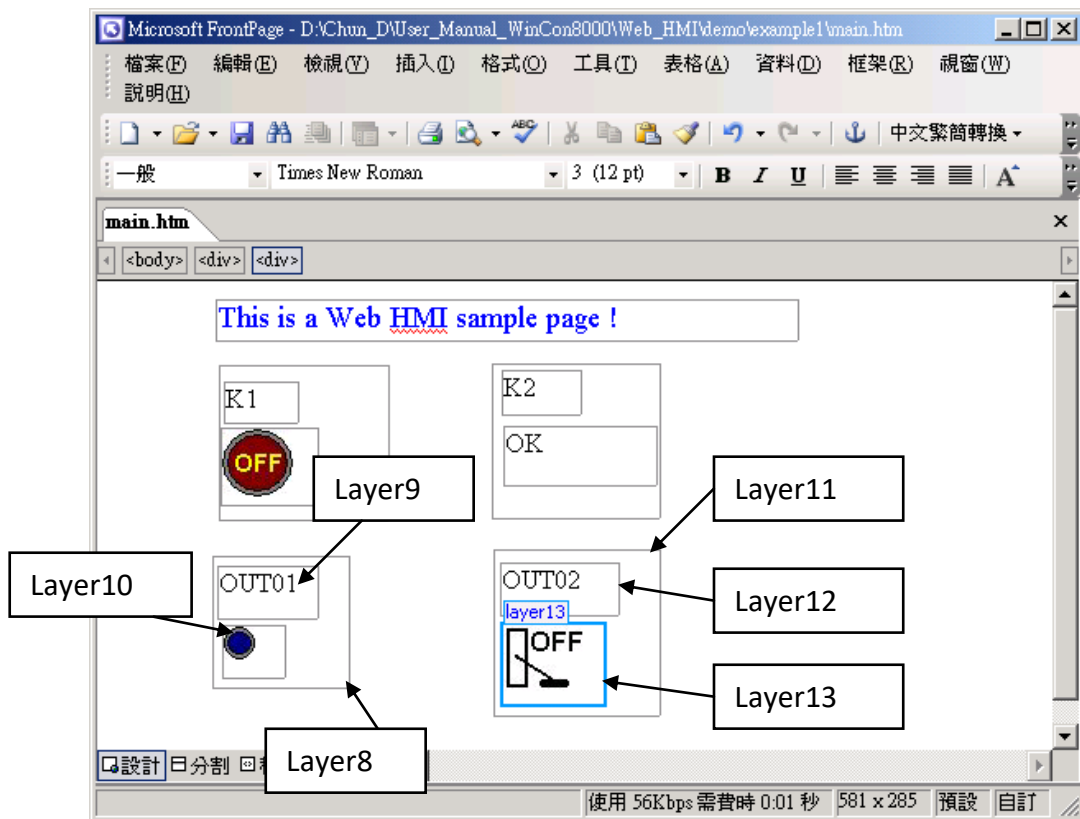

We will use OUT01 to display the state of the first output of the I-87055W board, while “OUT02” is for controlling and displaying the second output of the I-87055W.

Now please insert one another “Layer14”. Inside the “Layer14” please insert one “Layer15” with a “T1 = xxx ms” symbol. And two empty Layers – “Layer16” & “Layer17” just below the “Layer15”. We will use T1 to display the Timer value “T1” in the ISaGRAF project.

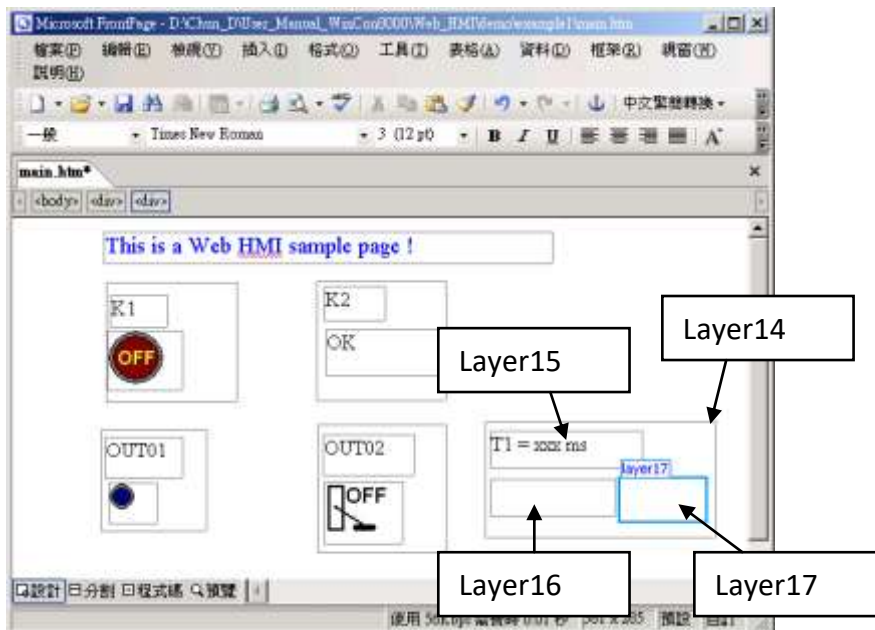

Click on “Save” to save this page.

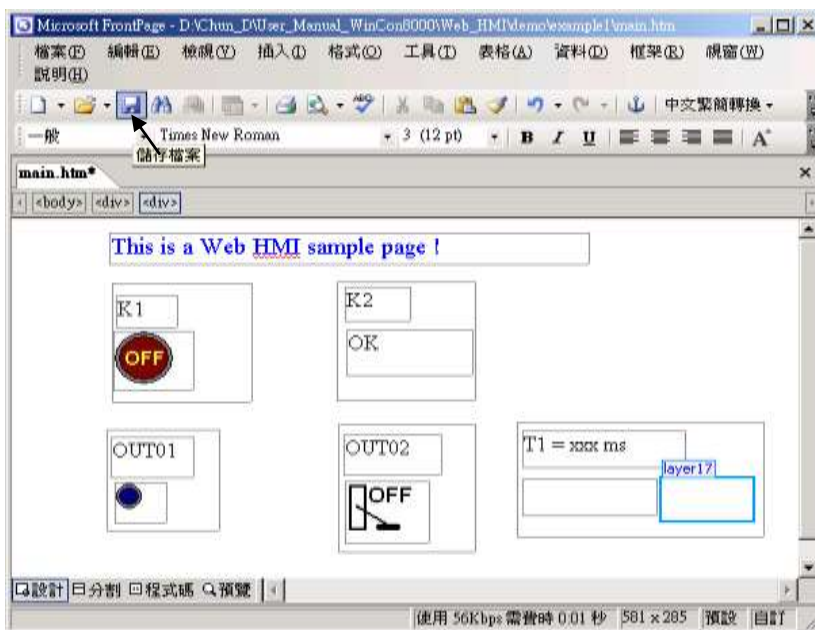

4.4.3 Step 3 – Adding Control Code To The Main.htm

Please switch the window to the source code. A valid HTML document will contain the basic objects as below.

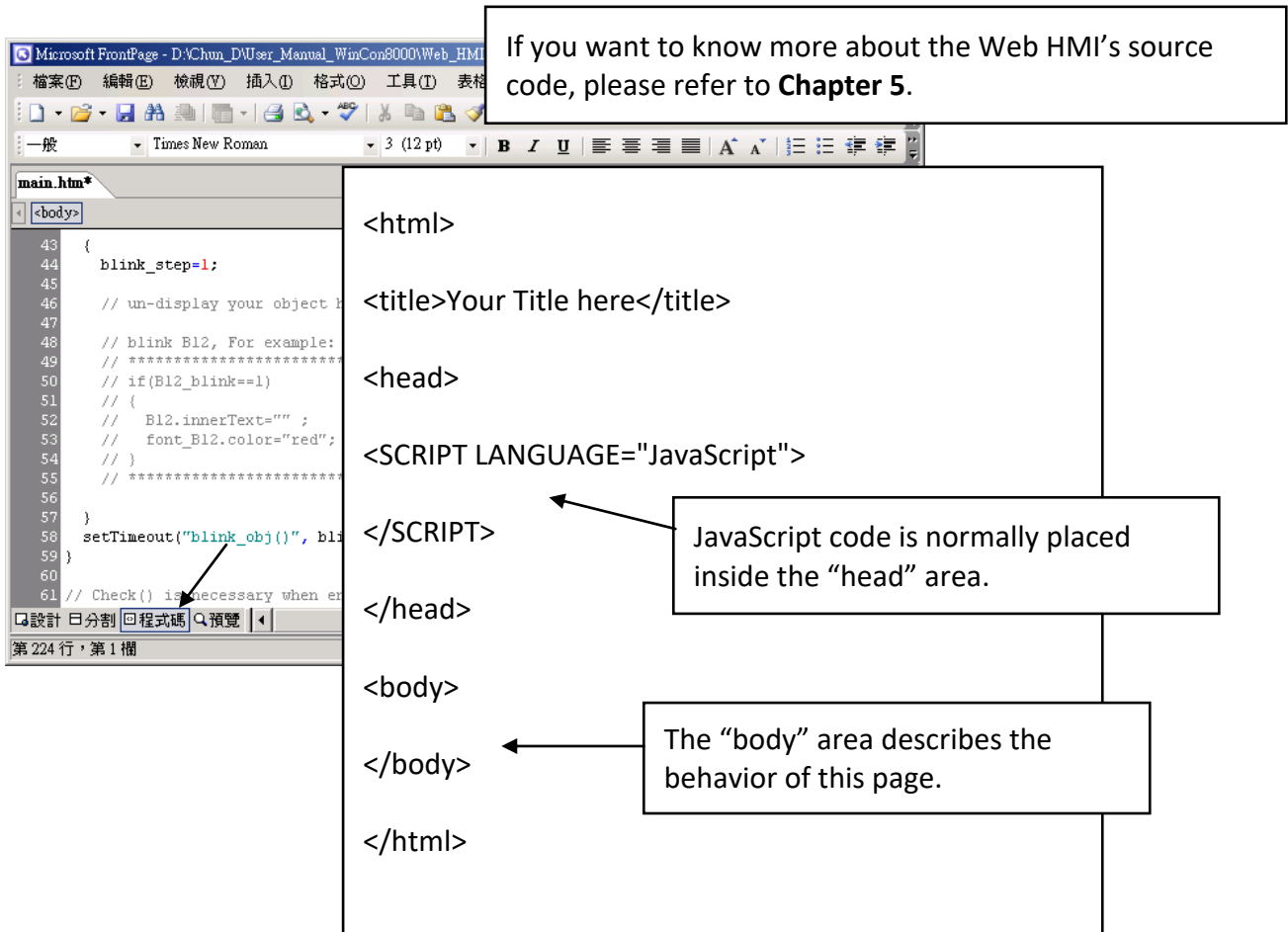

If you want to know more about the Web HMI's source code, please refer to **Chapter 5**.

```
<html>
<title>Your Title here</title>
<head>
<SCRIPT LANGUAGE="JavaScript">
</SCRIPT>
</head>
<body>
</body>
</html>
```

JavaScript code is normally placed inside the "head" area.

The "body" area describes the behavior of this page.

Please go to the **<body>** area and then modify the code as below.

Caption Area: Layer1
A Layer is starting with "<div " & ending with "</div>" tag

```
<!-- Caption -->  
<font color="blue" size="4">  
<div style="position: absolute; width: 353px; height: 24px; z-index: 1; left: 73px; top: 12px" id="layer1">  
This is a Web HMI sample page </div>  
</font>
```

K1 Area: Layer2 to Layer4

```
<div style="position: absolute; width: 102px; height: 93px; z-index: 2; left: 75px; top: 52px" id="layer2">  
<div style="position: absolute; width: 44px; height: 24px; z-index: 1; left: 3px; top: 10px" id="layer3">  
K1</div>  
<div style="position: absolute; width: 58px; height: 46px; z-index: 2; left: 1px; top: 38px" id="layer4">  
</div>  
<p>&nbsp;</div>
```

Please insert name="B11" just after the "<img "

K2 Area: Layer5 to Layer7

```
<div style="position: absolute; width: 101px; height: 93px; z-index: 3; left: 241px; top: 51px" id="layer5">  
<div style="position: absolute; width: 47px; height: 26px; z-index: 1; left: 6px; top: 4px" id="layer6">  
K2</div>  
<div style="position: absolute; width: 92px; height: 35px; z-index: 2; left: 7px; top: 38px" id="layer7">  
  
<font id="font_B12" color="blue" size="3">  
<b id="B12"> OK </b>  
</font> </div>
```

Please modify "OK <div>" to become

```
<font id="font_B12" color="blue" size="3">  
<b id="B12"> OK </b>  
</font> </div>
```

OUT01 Area: Layer8 to Layer10

```
<div style="position: absolute; width:82px; height:79px;z-index:4; left:71px; top:168px" id="layer8">  
<div style="position: absolute; width: 60px; height: 31px; z-index: 1; left: 3px; top: 6px" id="layer9">  
OUT01</div>  
<div style="position: absolute; width: 37px; height: 31px; z-index: 2; left: 6px; top: 42px" id="layer10">  
</div>  
<p>&nbsp;</div>
```

Please insert name="B1" just after the "<img "

OUT02 Area: Layer11 to Layer13

```

<div style="position: absolute; width:100px; height:100px; z-index: 5; left:242px; top:164px"
id="layer11">
<div style="position: absolute; width: 71px; height: 31px; z-index: 1; left: 4px; top: 8px" id="layer12">
OUT02</div>
<div style="position: absolute; width: 61px; height: 48px; z-index: 2; left: 5px; top: 45px" id="layer13">
</div>

```

```

<form name="form_B2" method="post" action="./main.dll">
  <input name="BEGIN" type="hidden">
  <input name="B2" type="hidden" value="0">
  <input name="END" type="hidden">
</form>

```

```
<p>&nbsp;</div>
```

Please insert
 Style="cursor:hand" name="B2" onclick="ON_OFF(form_B2,
 form_B2.B2, boolean_val[2])" just after the "<img " tag

Please insert
 <form name="form_B2" method="post" action="./main.dll">
 <input name="BEGIN" type="hidden">
 <input name="B2" type="hidden" value="0">
 <input name="END" type="hidden">
 </form>

T1 Area: Layer14 to Layer17

```

<div style="position: absolute; width: 181px; height: 90px; z-index: 6; left: 374px; top: 162px"
id="layer14">
<div style="position: absolute; width: 119px; height: 28px; z-index: 1; left: 4px; top: 7px" id="layer15">

```

```
T1 = <b id="T1">xxx ms</b></div>
```

Please modify "T1 = xxx ms </div>" to become :
 T1 = <b id="T1">xxx ms</div>

```
<div style="position: absolute; width: 98px; height: 28px; z-index: 2; left: 4px; top: 45px" id="layer16">
```

```

<form name="form_L21" method="post" action="./main.dll">
  <input name="BEGIN" type="hidden">
  <input name="L21" type="text" size="8" value="xxx">
  <input name="END" type="hidden">
</form>

```

```
&nbsp;</div>
```

Please insert below code inside "Layer16"
 <form name="form_L21" method="post" action="./main.dll">
 <input name="BEGIN" type="hidden">
 <input name="L21" type="text" size="8" value="xxx">
 <input name="END" type="hidden">
 </form>

```
<div style="position: absolute; width: 67px; height: 33px; z-index: 3; left: 106px; top: 44px" id="layer17">
```

```
  <input type="button" value="Enter" onclick="Check_L21( )">
```

```
  &nbsp;  </div>
```

```
<p>&nbsp;  </div>
```

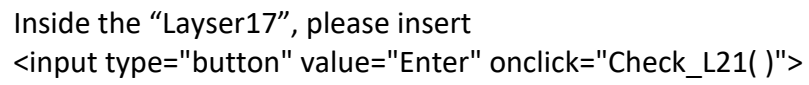

Inside the "Layer17", please insert
<input type="button" value="Enter" onclick="Check_L21()">

We have finished the code in the <body> </body> area.

Now please go to the “head” area

In the “head” area, please modify the sample code to be as below.

```
// variable to record object's blink state, 0:not blink, 1: blink, For example:  
// *****  
var B12_blink=0; // init as 0:not blink  
// *****
```

```
// function to blink object  
var blink_step=0;  
function blink_obj()  
{  
  if(blink_step==1)  
  {  
    blink_step=0;  
  
    // display your object here  
    // blink B12, For example:  
    // *****  
    if(B12_blink==1)  
    {  
      B12.innerText="Error !" ;  
      font_B12.color="red";  
    }  
    // *****  
  
  }  
  else  
  {  
    blink_step=1;  
  
    // un-display your object here  
    // blink B12, For example:  
    // *****  
    if(B12_blink==1)  
    {  
      B12.innerText="";  
      font_B12.color="red";  
    }  
    // *****  
  
  }  
  setTimeout("blink_obj()", blink_period);  
}
```

The “Error !” symbol will blink when the K2 = True in this example. Please un-mask the code inside these 3 areas.

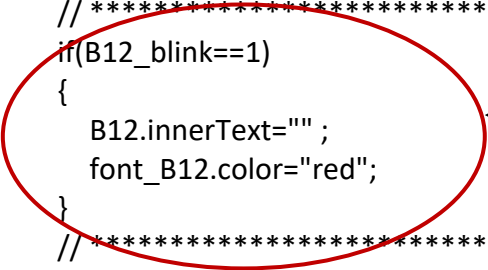
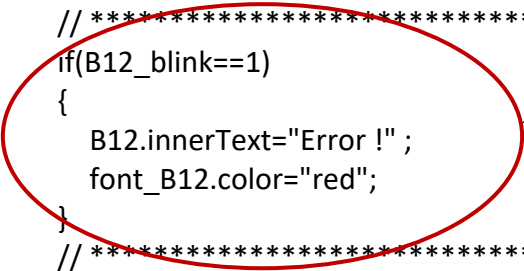
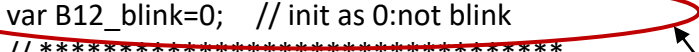

We need a function "Check_L21 to check the entered T1 value and post it to the ViewPAC.
Please un-mask the sample code to be as below.

```
// form sample, to check value of L21 & then post val to controller
// For example:
// *****
function Check_L21()
{
  var val=form_L21.L21.value;
  if(val>12000 || val<4000)
  {
    alert("T1's value should be in the range of 4000 to 12000");
    return;
  }
  Check(form_L21); // post value to the controller
}
// *****
```

And also inside the "refresh_data()" function, please insert below code.

```
// To refresh displayed data, this function is called by IE about every 1.5 sec later
```

```
function refresh_data()
{
  B1.src = "./img/circle_blue" + boolean_val[1] + ".jpg";
  B2.src = "./img/cmd" + boolean_val[2] + ".jpg";

  B11.src = "./img/big_Tcircle_red" + boolean_val[11] + ".jpg";

  if(boolean_val[12]==0)
  {
    B12.innerText="Ok";
    font_B12.color="blue";
    B12_blink=0;
  }
  else
  {
    B12_blink=1;
  }

  T1.innerText=timer_val[21] + " ms";
}
```

Now we have finished all the code. Please save it.

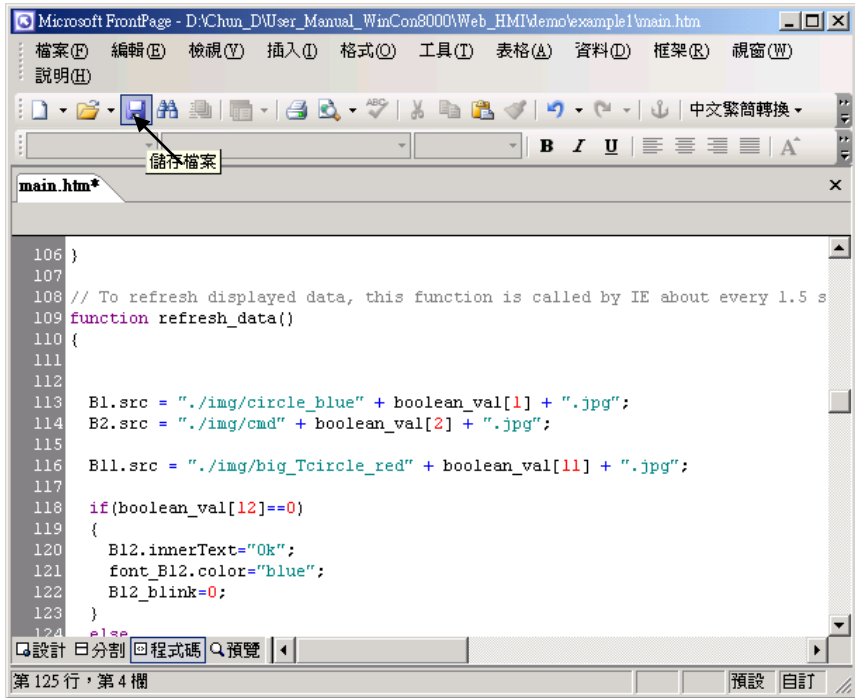

You may click on "Preview" to simulate its run time behavior.

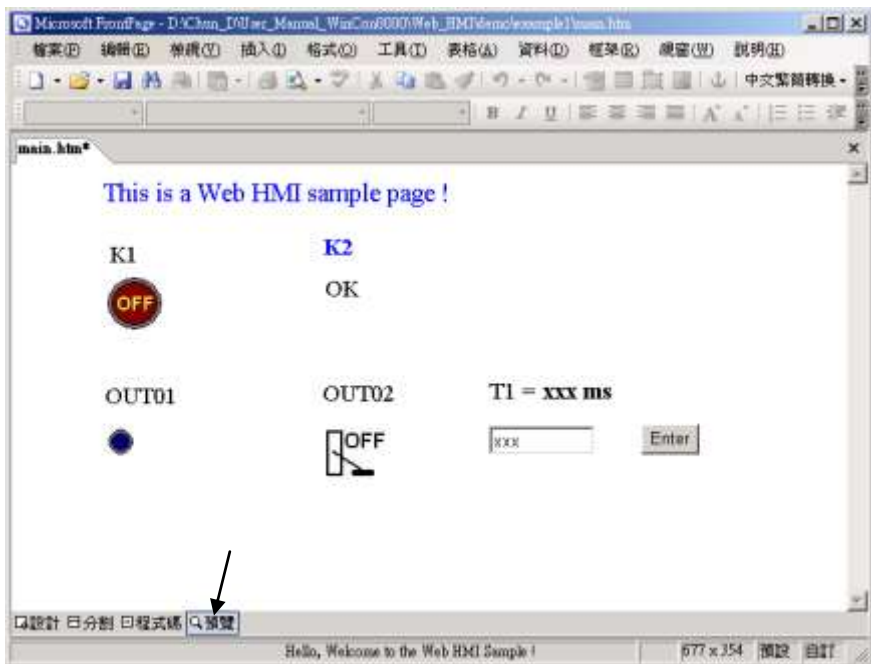

4.4.4 Step 4 – Download Web HMI Pages To The Controller

The steps are similar as listed in [Section 3.2](#). If you haven't practiced "Setting Up A Web HMI Demo" listed in the [Chapter 3](#), it's better to do it once to get familiar with it.

Set the Web Options.

Check on "Enable Web HMI" and then click on "Setting", Please check on "Enable Account Security" and then click on "Edit" to set (username , password). **Then remember to click on "OK"**.

Note: If "Enable Account Security" is not check, any user can easily get access to your ISaGRAF WinCE ViewPAC through the Internet Explorer.

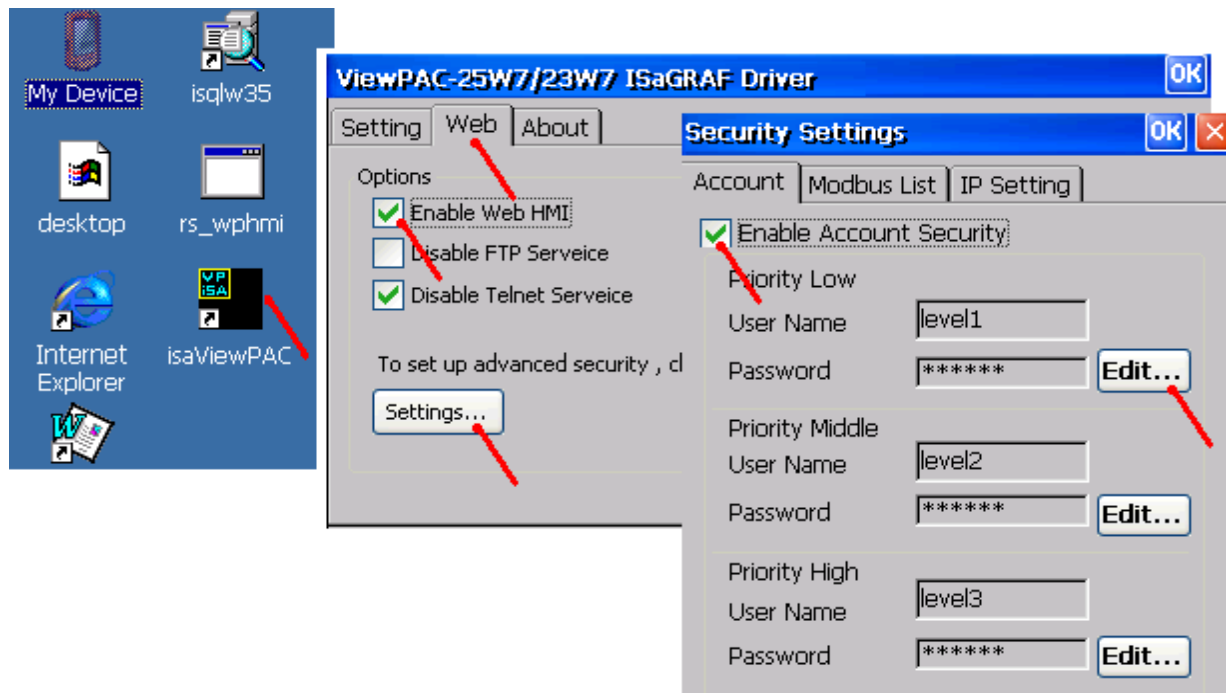

And then, please copy all files in this example1 to the controller

`<your hard drive>:\example1\ *.*`

to the ViewPAC 's

`Micro_SD\Temp\HTTP\WebHMI\`

Since the Web Pages are modified or new copied, please run "rs_wphmi.exe" to reset the Web server. **The "rs_wphmi.exe" must be run every time when user has modified any file in the ViewPAC 's \Micro_SD\Temp\HTTP\WebHMI**

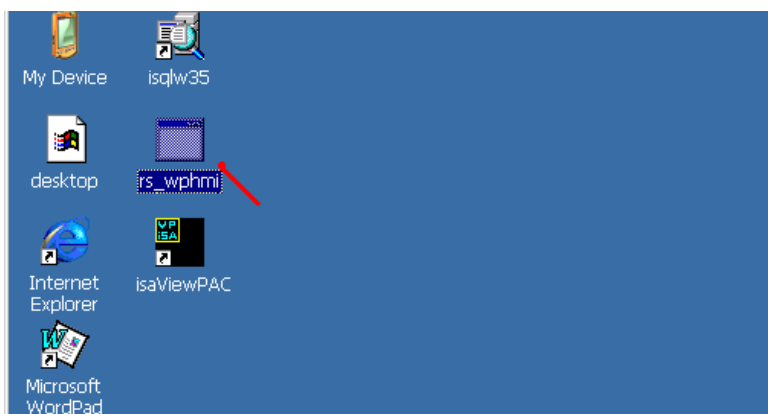

Show Time:

Please run Internet Explorer (Rev. 6.0 or higher), key in the IP address of your ViewPAC. For example: 61.218.42.10 or <http://61.218.42.10>

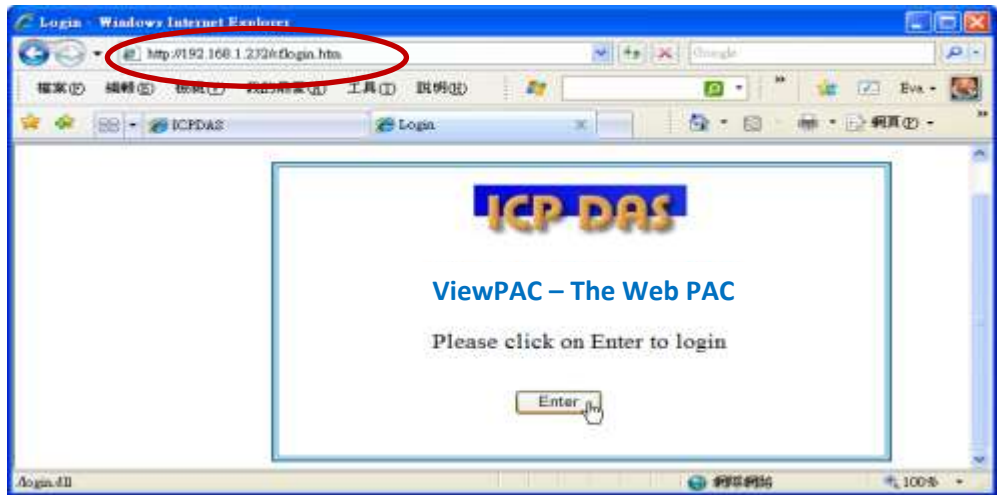

If there is something wrong with the web page. You may enable the below item to display the debug message every time it has error.

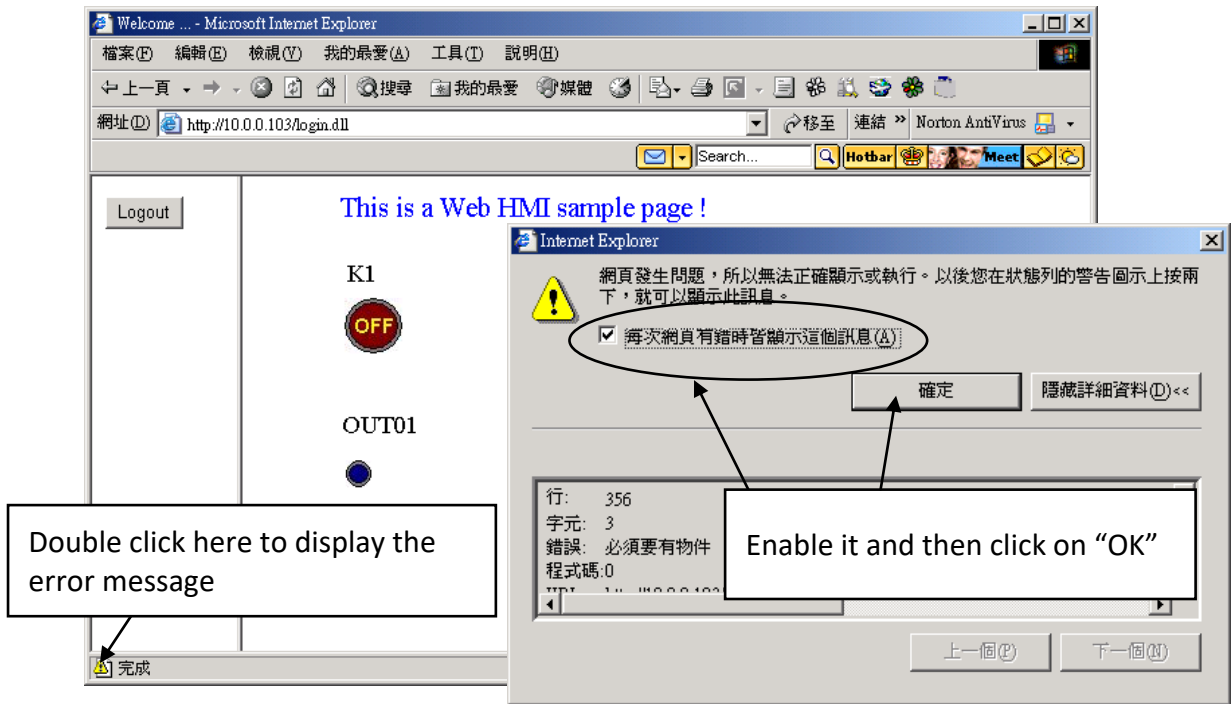

And also check if your ISaGRAF project already download to the controller ([Section 4.3](#) or [section 3.2.3](#)).

And do you assign the correct Modbus Network address to the respective ISaGRAF variables ? ([Section 4.1.5](#))

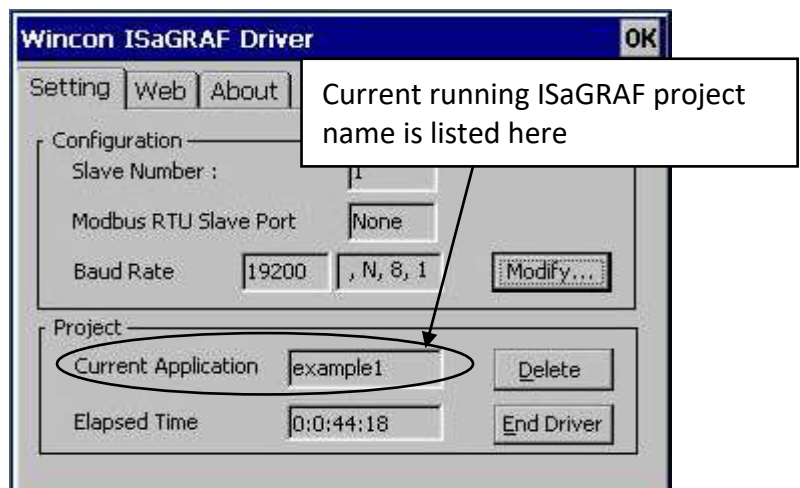

Chapter 5 Web HMI Basics

Important Notice:

1. ISaGRAF WinCE ViewPAC support only High profile I-8K and I-87K I/O cards in slot 0 to 2. Please refer to the accompanying CD-ROM: \napdos\isagraf\vp-25w7-23w7\english-manu\ Datasheet files.
2. Please always set a **fixed IP** address to the ISaGRAF WinCE ViewPAC. (**No DHCP**). Recommend to use the NS-205/208 or RS-405/408 Industrial Ethernet Switch for them.

Note:

1. This chapter describes the programming basics for the Web HMI. We will not focus on the HTML basics. If you want to know more about the HTML programming, the best way is to “buy a HTML related book” from the bookstore. There are a lot of books doing this job.
2. The Web HMI only supports the basic HTML tags. It doesn't support ASP, PHP or JSP or other Page Server language.
3. Please do not use <frameset> </frameset> , <frame> </frame> in the Web HMI.
4. Note: The object name, object ID, code, variable name and function name is case sensitive. For example, refresh_data() and Refresh_data() is different.
5. There are more than ten Web HMI examples in the VP-25W7/23W7 CD-ROM. Please refer to the [section 3.1](#).

5.1 Basic Files For The Web HMI

The basic Web HMI files include 2 folders and 3 DLL files and 4 htm files as below.

Folders		
1	./img/	(default image files - *.jpg , *.bmp , *.gif)
2	./msg/	(default message files – wincon.js & xxerror.htm)
DLL Files		
1	whmi_filter.dll	(three DLL files)
2	login.dll	
3	main.dll	
HTM Files		
1	index.htm	(first default page)
2	login.htm	(the Web HMI welcome page)
3	menu.htm	(the page-menu page, normally on the left on the Internet Explorer)
4	main.htm	(first page when successfully login)

- User may put his own image files into the folder named as “user_img”. And put user-defined JavaScript file or css file into the folder named as “user_msg”. Other folder name is not acceptable by the ViewPAC Web HMI.
- The “index.htm” file is the default entry page of the web server. User must not modify it. The “index.htm” re-directs to the “login.htm” file in 1 to 2 seconds when someone visits the ViewPAC via the Internet Explorer.
- User may modify the “login.htm” , “menu.htm” and “main.htm” to fit the requirement.

5.2 Login.htm

Login.htm is the first welcome page when a user visiting in. It can be modified.
Below is the basic code for the **login.htm**

```
<html>
<head>

<title>Login</title>

<meta http-equiv=pragma content=no-cache>

<meta http-equiv="Content-Type" content="text/html; charset=UTF-8" >

<script language="JavaScript">
var random_val=123;
function get_random_val()
{
    var rightNow = new Date();
    random_val += 323456789*rightNow.getMinutes() +
                107654321*(rightNow.getTime()%1000);
    setTimeout("get_random_val()", 197); // repeat call
}

//check if username and possword are empty
function validate(fm)
{
    setKey(fm);
    return true;
}

//Embed key while submitting
function setKey(fm)
{
    var rightNow = new Date();
    cookieVal = random_val+rightNow.getTime();
    fm.key_.value = cookieVal;
}
</script>

</head>
```

This row is only for the "Login.htm" , please do not apply to other pages. For example, the "menu.htm" & "main.htm" & other.htm pages.

Please apply your charset here.
For example,
English: UTF-8
Simplified Chinese: gb2312
Traditional Chinese: big5
or other language

get_random_val() should be always called at the beginning of the Login.htm . It is the entry point of the Login.htm

```
<body onload="get_random_val()">
```

```
<div style="position: absolute; width: 332px; height: 34px; z-index: 5; left: 147px; top: 27px" id="layer1">
```

```
  Welcome !</div>
```

Your caption here.

```
<div style="position: absolute; width: 122px; height: 38px; z-index: 4; left: 171px; top: 95px;" id="layer2">
```

"form1" is necessary

```
  <form name="form1" action="/login.dll" method="post">
```

```
    <input type="hidden" name="key_">
```

```
    <input type="submit" name="Submit" value=" Enter " style="cursor: hand" onClick="return validate(this.form)">
```

```
  </form>
```

```
</div>
```

```
</body>
```

```
<!-- To ensure no-cache work -->
```

```
<head>
```

```
<meta http-equiv=pragma content=no-cache>
```

```
</head>
```

```
</html>
```

You may modify " Enter " to your own word. For example "請進". This may require to modify the related charset at the beginning of this page.

This code is only for the "Login.htm" , please do not apply to other pages. For example, the "menu.htm" & "main.htm" & other .htm pages.

That's all the login.htm need. You can insert more images or text to it. Only remember to keep its basic code.

5.3 menu.htm

Note:

If you want to know more about the multi-page application, there are two demos in the ISaGRAF WinCE ViewPAC CD:

\napdos\isagraf\vp-25w7-23w7\vp-webhmi-demo\ vphmi_05 & vphmi_05a.

The “vphmi_05” place its page-menu on the left, while “vphmi_05a” on the top.

The “Menu.htm” defines the Page-menu of the Web HMI especially for the multi-page application. The page-menu can place only on the left or on the top.

On the left.
The width & scrolling can be modified.

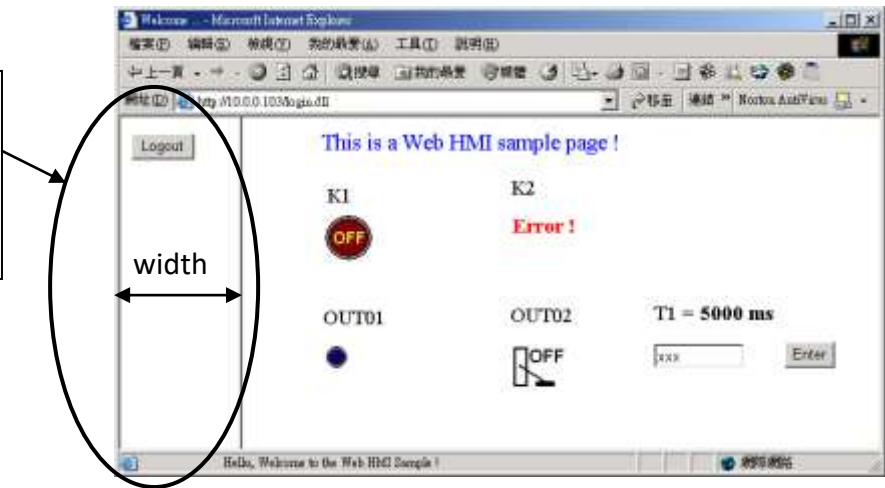

On the top.
The width & scrolling can be modified.

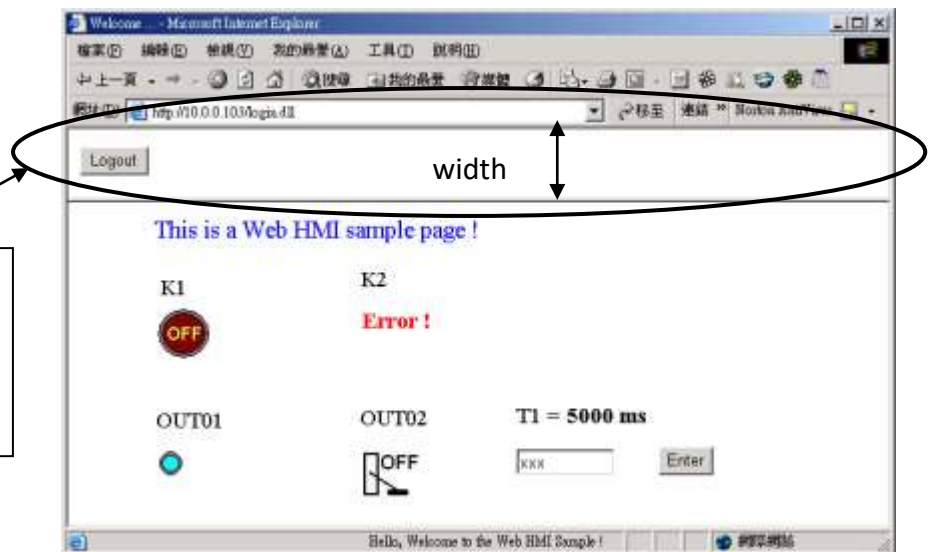

Below is the basic code for the **menu.htm**

```
<!-- top_or_left=1 , scrolling=0 , width=60 , resize=1 -->
```

The first row is not a comment, it defines the Page-Menu behavior

top_or_left:	1:Top , 0:Left
scrolling:	1:Yes , 0:No
width:	width of the Menu Frame, 0 – 999 (unit is pixel)
resize	1:Yes , 0:No

```
<html>  
<head>  
<title>Title1</title>
```

```
<meta http-equiv="Content-Type" content="text/html; charset=UTF-8" >
```

```
<SCRIPT LANGUAGE="JavaScript" src="./msg/wincon.js"></SCRIPT>
```

```
<SCRIPT LANGUAGE="JavaScript">
```

```
function start1()  
{  
  A_11();  
}  
function refresh_data()  
{  
  if(run_at_pc==1) return;  
}  
</SCRIPT>
```

This row is necessary for menu.htm, main.htm & other multi-pages

Please apply your charset here.
For example,
English: UTF-8
Simplified Chinese: gb2312
Traditional Chinese: big5
or other language

```
</head>
```

start1() is the entry point of the menu.htm

```
<body onload="start1()">
```

form_logout is for the logout button.

```
<!-- Logout button -->  
<form name="form_logout" method="post" action="./login.dll">  
  <input style="cursor:hand" name="CMD" type="submit" value="Logout"  
    onClick="return logout(this.form)">  
</form>
```

```
</body>  
</html>
```

Note:

If you want to know more about the multi-page application, there are two demos in the VP-2xW7/4xx7 CD:

\\napdos\isagraf\vp-25w7-23w7\vp-webhmi-demo\ vphmi_05 & vphmi_05a .
The "vphmi_05" place its page-menu on the left, while "vphmi_05a" on the top.

5.4 main.htm

5.4.1 A Simple Main.htm Example

Before going further in the main.htm, first take a look at a simple main.htm example. This example only display a "Hello !" message when successfully login, nothing else.

```
<html>
<head>
<title>Title1</title>
<meta http-equiv="Content-Type" content="text/html; charset=UTF-8" >

<SCRIPT LANGUAGE="JavaScript" src="./msg/wincon.js"></SCRIPT>

<SCRIPT LANGUAGE="JavaScript">
show_scroll_word(200,"Hello, Welcome to the Web HMI Sample !");

function refresh_data()
{
}

</SCRIPT>
</head>

<body onLoad="init()">

<font color="blue" size="4">
<div style="position: absolute; width: 353px; height: 24px; z-index: 1; left: 73px;
top: 12px" id="layer1"> Hello !</div>
</font>

</body>
</html>
```

Please apply your charset here. For example, English: UTF-8 , Simplified Chinese: gb2312 , Traditional Chinese: big5 , or other language

This line is necessary for menu.htm , main.htm & other multi-pages

Calling show_scroll_world() will display a moving word at the bottom of the Internet Explorer. Here 200 means 200 ms. You may make it slower, for example, using 500.

refresh_data() is called when the Internet Explorer has received the requested data from the controller. It is called in the period about 1.25 to 5 seconds depends on the communication quality.

init() is the entry pint of the main.htm & other multi-pages.

A layout object is starting with "<div" & ending at "</div>" tags. Here only show a message "Hello !"

You may replace the main.htm in the ISaGRAF WinCE ViewPAC CD-ROM:

\\napdos\isagraf\vp-25w7-23w7\vp-webhmi-demo\sample
to the above main.htm & download it to the controller (refer to [section 4.4.4](#)).

You will see the below window when you login successfully.



User may try to plug out the Ethernet cable of the ViewPAC or of your PC. You will see it show "Communication is temporary break now !" in about 10 seconds. When you plug the cable back, the communication will be recovered in about 10 to 45 seconds.

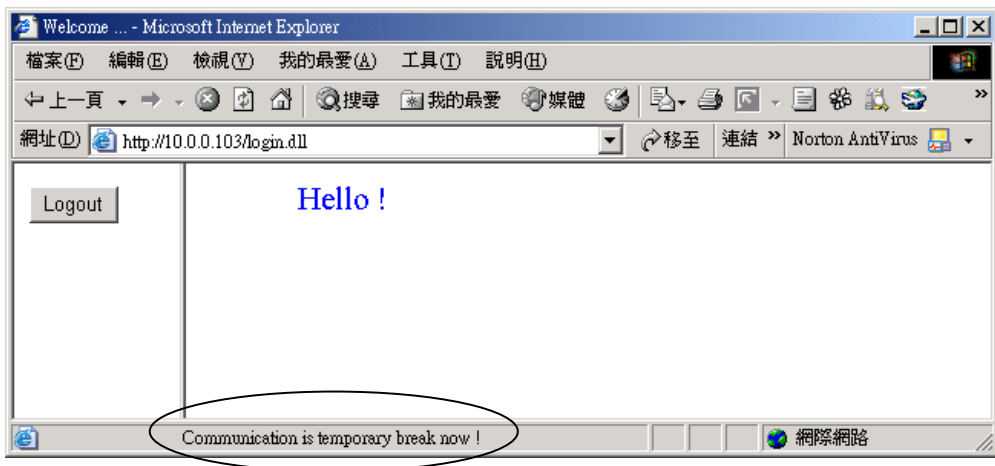

If the communication broken time exceeds 120 seconds, it will show the below message. You have to close the Internet Explorer & open it again to re-login.



5.4.2 More About The refresh_data() Function And Dynamic Data

Note: The code, variable name and function name is case sensitive. For example, refresh_data() is correct, however Refresh_data() is not correct.

The refresh_data() function must always apply in the main.htm and other multi-pages. It is called when the Internet Explorer has received the requested data from the controller. The calling period is about 1.25 to 5 seconds depends on the communication quality

The refresh_data() is often used for refreshing the dynamic data. For example, the Boolean value , integer value, timer value or float value of the variables in the ISaGRAF project.

The Internet Explorer can access to the data in the ISaGRAF project only when they are assigned a unique Modbus Network Address No (refer to [section 4.1.5](#)). The Web HMI only accepts Network Address No in the range of 1 to 1024. The data without a Network Address No (No. = 0) or not in the range of (1 to 1024) is not accessible by the Internet Explorer.

The main.htm and other multi-pages can use the below variable array to access to the ISaGRAF's data (case sensitive). The identifier appeared in the [] is the related Network Address No. For example boolean_val[2] means the Boolean value of the ISaGRAF Boolean data which is assigned with the Network Address No. = 2.

boolean_val	Boolean value in the ISaGRAF
word_val	word value in the ISaGRAF, -32768 to +32767
float_val	real value in the ISaGRAF, for ex, 1.234 , -0.456E-02
timer_val	timer value in the ISaGRAF, unit is ms, max = 86399999 (< 1 day)
string_val	message value in the ISaGRAF, max string length is 255

To access to long integer value (32-bit integer) please use get_long_val() function. For example, get_long_val(11) , get_long_val(13) , get_long_val(15).

get_long_val()	long integer value in the ISaGRAF, -2147483648 ~ +2147483647
-----------------	--

Note:
The long integer, timer and float variable's Network Address No. must occupy 2 No. in the ISaGRAF project (refer to section 4.2 of "User's Manual of ISaGRAF Embedded Controllers" or in the CD-ROM: \napdos\isagraf\vp-25w7-23w7\english-manu\ " User_Manual_I_8xx7.pdf").

That means if you assign a Network Address No.= 11 to a Real type variable(or Timer or integer will have 32-bit value – larger than 32767 or smaller than -32768), the next No. 12 should not assigned to any other variable in the ISaGRAF project. However you may assign No.=13 to one another variable.

5.4.2.1 Displaying Dynamic Boolean Data

Demo example: vphmi_02 and vphmi_05 ([section 3.1](#))

Let's look back to the refresh_data function. If user want to display the dynamic boolean value, the below code can be used.

```
...  
function refresh_data()  
{  
  B1.src = "./img/circle_blue" + boolean_val[1] + ".jpg" ;  
}  
...  
<body onLoad="init()">  
...  
<div style="position: absolute; width: 214px; height: 53px; z-index: 2; left: 102px; top: 79px">  
</div>  
...  
</body>
```

The action of the image object "B1" is defined here.

if boolean_val[1]=1, it display image "B1" as "img/circle_blue1.jpg"
if boolean_val[1]=0, it display image "B1" as "img/circle_blue0.jpg"

The layout (or location) of the image object "B1" is defined here by the "<div" and "</div>" tags.

The declaration of image "B1" is defined here by the "img" tag & name="B1" src= ... ← "src=" defines the initial value of B1

5.4.2.2 Displaying Dynamic Float & Word & Timer Data

Demo example: vphmi_01 , vphmi_03 and vphmi_05 ([section 3.1](#))

If user want to display the dynamic float value, the below code can be used.

```
...  
function refresh_data()  
{  
  F21.innerText = float_val[21] ;  
}  
...  
<body onLoad="init()">  
...  
<div style="position: absolute; width: 214px; height: 53px; z-index: 2; left: 102px; top: 79px">  
<b id="F21"> xxxx </b> </div>  
...  
</body>
```

The action of the Text object "F21" is defined here.

If want to display Word data, please use "word_val[]"
If want to display Timer data, please use "timer_val[]".
For ex, F21.innerText = timer_val[21] + " ms";

The layout (or location) of the Text object "F21" is defined here by the "<div" and "</div>" tags.

The declaration of Text object "F21" is defined here by the "<b" tag & id="F21" & "" tag initial value of this F21 is "xxxx"

5.4.2.3 Displaying Dynamic Long Integer Data

Demo example: vphmi_03 and vphmi_05 ([section 3.1](#))

If user want to display the dynamic long integer value (32-bit format), the below code can be used.

```
...
function refresh_data()
{
  L11.innerText = get_long_val(11);
}

```

The action of the Text object "L11" is defined here.

```
<body onLoad="init()">
...
<div style="position: absolute; width: 214px; height: 53px; z-index: 2; left: 102px; top: 79px">
<b id="L11"> xxx </b> </div>
...
</body>

```

The layout (or location) of the Text object "L11" is defined here by the "<div" and "</div>" tags.

The declaration of Text object "L11" is defined here by the "<b" tag and id="L21" and "" tag, the initial value of this L11 is "xxx"

5.4.2.4 Displaying Dynamic String Data

If user want to display the dynamic string value (max length is 255), the below code can be used.

```
...
function refresh_data()
{
  S31.innerText = string_val[31];
}
...

```

The action of the Text object "S31" is defined here.

```
<body onLoad="init()">
...
<div style="position: absolute; width: 214px; height: 53px; z-index: 2; left: 102px; top: 79px">
<b id="S31"> empty </b> </div>
...
</body>

```

The layout (or location) of the Text object "S31" is defined here by the "<div" and "</div>" tags.

The declaration of Text object "S31" is defined here by the "<b" tag and id="S31" and "" tag, the initial value of this S31 is "empty"

5.4.2.5 Trigger A Boolean Object To Blink

Demo example: vphmi_02 and vphmi_05 ([section 3.1](#))

Some application may need a message to blink when the Boolean value changes. For example, if boolean_val[12] is False, it means "OK".

However if boolean_val[12] is True, it means "Error !". User may want to make this "Error !" blink to attract viewer's attention.

The below code can do this job.

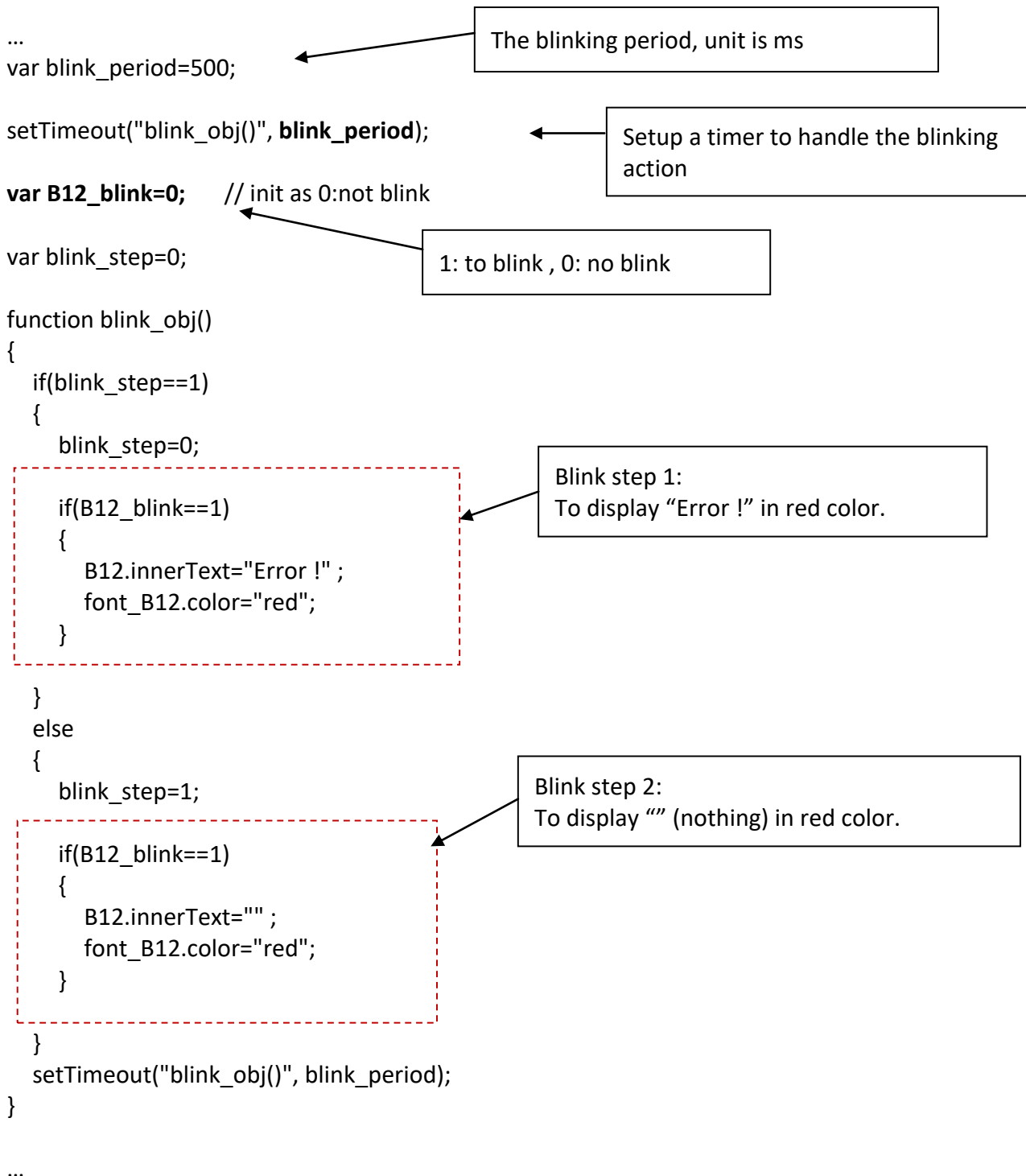

```
function refresh_data()
{
```

```
    if(boolean_val[12]==0)
    {
        B12.innerText="Ok";
        font_B12.color="blue";
        B12_blink=0;
    }
    else
    {
        B12_blink=1;
    }
}
```

The action of the Text object "B12" is defined here.
If boolean_val[12]=0, no blink.
However If boolean_val[12]=1, blink.

```
}
...
<body onLoad="init()">
```

The layout (or location) of the Text object "B12" is defined here by the "<div>" and "</div>" tags.

```
...
<div style="position: absolute; width: 214px; height: 53px; z-index: 2; left: 102px; top: 79px">
```

```
<font id="font_B12" color="blue" size="3">
```

```
<b id="B12">OK</b>
```

The "" & "" tags can be used for controlling the font's color and font's size.

```
</font>
```

```
</div>
```

The declaration of Text object "B12" is defined here by the "" tag and id="B12" and "" tag, the initial value of this B2 is "OK"

```
</body>
```

5.4.2.6 Displaying Float Value With Fixed Digit Number Behind The "." Symbol

Demo example: vphmi_06 and vphmi_07 ([section 3.1](#))

The float_str1(para1 , para2) function can convert float value to a string with fixed digit number behind the dot "." symbol

para1 is the float value to be converted, for ex, 1.234567
para2 is the digit number behind the "." dot symbol, 0 to 6
Ex, float_str1(1.234567, 3) return "1.234" ,
float_str1(1.234567, 2) return "1.23"

```
...
function refresh_data()
{
    F21.innerText = float_str1( float_val[21] , 3 );
}
```

Convert float val at Network Address 21 to a string with digit number = 3 behind the "." dot symbol

5.4.3 Post Data To The Controller

The former [section 5.4.2](#) listing how to get and display data from the controller. This section focuses on posting data to the controller, in other word to control the ViewPAC via the Internet Explorer.

To set a new value to the Boolean, word, long integer, float , timer and string variables in the ISaGRAF project, we need “form” object appeared in the main.htm or other multi-pages. A “form” object looks like as below.

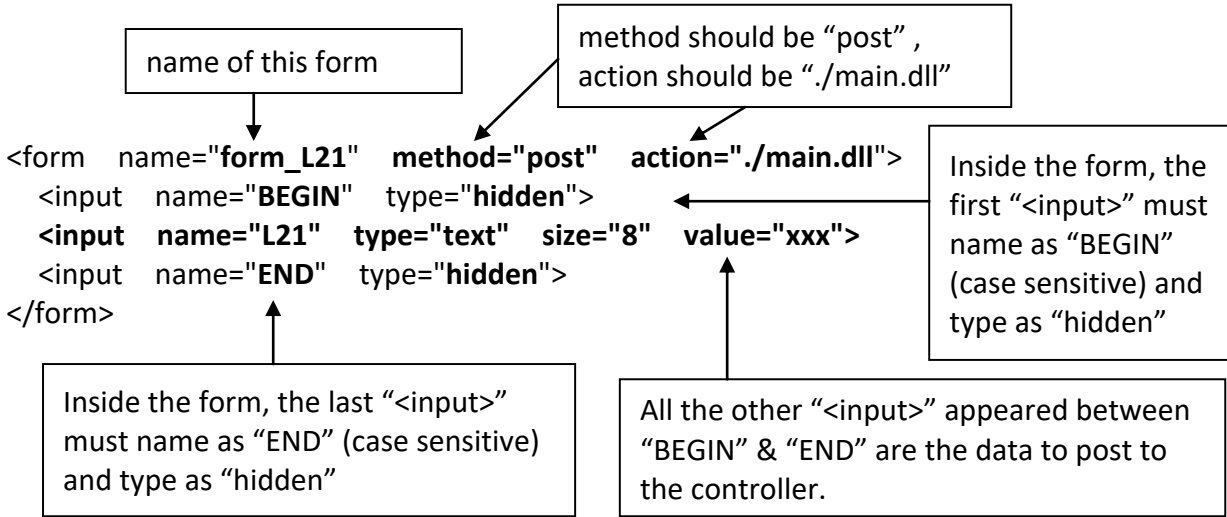

The “<input>” name to control the ViewPAC’s data must follow below format. The number followed behind the first letter should be in the range from 1 to 1024. This number point to the variable name in the ISaGRAF project with the same Modbus Network Address No.

- B point to the ISaGRAF boolean data , for ex, B5 , B109
- W point to the ISaGRAF word data (-32768 to +32767), for ex, W9 , W1001
- L point to the ISaGRAF long integer data (-2147483648 to +2147483647), for ex, L21. This “L” Also point to the ISaGRAF timer data
- F point to the ISaGRAF real data, for ex, F13 , F235
- S point to the ISaGRAF message data , for ex, S18

Note:
The long integer, timer and float variable’s Network Address No. must occupy 2 No. in the ISaGRAF project (refer to section 4.2 of “User’s Manual of ISaGRAF Embedded Controllers” or in the CD-ROM: \napdos\isagraf\vp-25w7-23w7\english-manu\ “ User_Manual_I_8xx7.pdf”)

That means if you assign a Network Address No.= 11 to a Real type variable(or Timer or integer will have 32-bit value – larger than 32767 or smaller than -32768), the next No. 12 should not assigned to any other variable in the ISaGRAF project. However you may assign No.=13 to one another variable.

5.4.3.1 Post Boolean Value to The Controller

A. To post by the image

ON_OFF function is used for posting Boolean value to the controller by refer to the current Boolean value.

```
function ON_OFF(form_obj, obj, current_boo_value)
```

```
{
  if(current_boo_value==0)
  {
    flag = confirm("turn ON ?");
    if(flag) obj.value=1;
  }
  else
  {
    flag = confirm("turn OFF ?");
    if(flag) obj.value=0;
  }
  if(flag)
  {
    if(GetUserID(form_obj)==true) form_obj.submit();
  }
}
```

The 1st parameter is the name of the "form".
The 2nd parameter is the "<input>" name inside the form.
The last parameter is the current Boolean value.

Demo example: vphmi_02 and vphmi_05

```
function refresh_data()
```

```
{
  B2.src = "img/cmd" + boolean_val[2] + ".jpg" ;
}
```

Display the current Boolean image. In this example, 0: display "img/cmd0.jpg", 1:"img/cmd1.jpg"

```
<body onLoad="init()">
```

The layout (or location) of the image object "B2" is defined here by the "<div" and "</div>" tags.

```
<div style="position: absolute; width:100px;height:100px; z-index: 5; left: 242px; top: 164px" >
```

"cursor:hand" will display the mouse arrow as a hand when entering the image area

```

```

Name of the image object

Name of the form

The onclick will call ON_OFF() when the mouse click on it.
The 1st parameter is the name of the "form". Here is "form_B2"
The 2nd parameter is the "<input>" name inside the form. Here is "form_B2.B2"
The last is the current boolean value. Here is boolean_val[2]

```
<form name="form_B2" method="post" action="/main.dll">
  <input name="BEGIN" type="hidden">
  <input name="B2" type="hidden" value="0">
  <input name="END" type="hidden">
</form>
```

Name of "<input>" inside the form. Here is "B2". Because it is inside "form_B2", then we must use the name of "form_B2.B2" to identify it.

```
</div>
...
</body>
```

B. To post by buttons

Demo example: vphmi_02 and vphmi_05

function ON_(form_obj, obj)

```
{
  flag = confirm("turn ON ?");
  if(flag)
  {
    obj.value=1;
    if(GetUserID(form_obj)==true) form_obj.submit();
  }
}
```

"ON_" function is used for posting Boolean value as "True" to the controller .

function OFF_(form_obj, obj)

```
{
  flag = confirm("turn OFF ?");
  if(flag)
  {
    obj.value=0;
    if(GetUserID(form_obj)==true) form_obj.submit();
  }
}
```

"OFF_" function is used for posting Boolean value as "False" to the controller .

function refresh_data()

```
{
  B2.src = "img/big_Tcircle_red" + boolean_val[2] + ".jpg" ;
}
```

Display the current boolean image.
In this example,
0: "img/big_Tcircle_red0.jpg" ,
1: "img/ big_Tcircle_red1.jpg"

```
...
<body onLoad="init()">
```

The layout (or location) of the image object "B2" is defined here by the "<div" and "</div>" tags.

```
...
<div style="position: absolute; width: 56px; height:40px; z-index: 5; left: 82px; top: 69px" >

</div>
```

```
<div style="position:absolute; left:85px; top:124px; width:42px; height:27px;">
<input type="button" value="ON" style="cursor:hand" onClick="ON_(form_B2, form_B2.B2)">
```

A button to call ON_(). First parameter is the name of the form. Here is "form_B2"
The second is the name of the "<input>" inside the form. Here is "form_B2.B2"

```
<form name="form_B2" method="post" action="/main.dll">
  <input name="BEGIN" type="hidden" value="">
  <input name="B2" type="hidden" value="1">
  <input name="END" type="hidden" value="">
</form>
</div>
```

Name of "<input>" inside the form. Here is "B2". Because it is inside "form_B2", then must use the name of "form_B2.B2" to identify it.

```
<div style="position:absolute; left:85px; top:166px; width:47px; height:31px">
<input type="button" value="OFF" style="cursor:hand" onClick="OFF_(form_B2, form_B2.B2)">
</div>
```

```
...
</body>
```

A button to call OFF_(). First parameter is the name of the form. Here is "form_B2"
The second is the name of the "<input>" inside the form. Here is "form_B2.B2"

5.4.3.2 Post Word & Long & Float & Timer & String Value to The Controller

```

function Check(form_obj)
{
  flag = confirm("Are you sure?");
  if(flag)
  {
    if(GetUserID(form_obj)==false) { return false; }
    form_obj.submit();
    return true;
  }
  else
  {
    return false;
  }
}

```

Check() is used for posting any "form".

Demo example:
vphmi_03, vphmi_04,
vphmi_05, vphmi_06 and
vphmi_07

```

function refresh_data()
{
  L15.innerText=get_long_val(15);
  F17.innerText=float_val[17];
}

```

Display dynamic value here.
 If data is word , please use word_val[]
 If data is timer , please use timer_val[]
 If data is string. please use string_val[]

```

<body onLoad="init()">
...

```

The layout (or location) of the text object "L15" & "F17" are defined here by the "<div>" and "</div>" tags.

```

<div style="position: absolute; width: 195px; height: 25px; z-index: 2; left: 45px; top: 52px" >
L15 = <b id="L15">xxx</b></div>
<div style="position: absolute; width: 196px; height: 29px; z-index: 3; left: 45px; top: 82px" >
F17 = <b id="F17">xxx</b></div>

```

```

<div style="position:absolute; left:47px; top:131px; width:204px; height:60px">
  <form name="form1" method="post" action="/main.dll">
    <input name="BEGIN" type="hidden" value="">
    <input name="L15" type="text" value="Enter long val (L15)">
    <input name="F17" type="text" value="Enter float val (F17)">
    <input name="END" type="hidden" value="">
  </form>
</div>

```

text input L15 & F17 inside the "form1" if data is timer, please use "L" . And "W" for word."S" for string

```

<div style="position:absolute; width:74px; height:31px; left: 234px; top: 150px;">
  <input type="button" style="cursor:hand" onClick="return Check(form1)" value="Enter">
</div>
...
</body>

```

"cursor:hand" will display the mouse arrow as a hand when entering the button area

When mouse click on this button, it calls Check() to post to the controller

5.5 Multi-Pages

The Web HMI in the ISaGRAF WinCE ViewPAC supports multi-pages application. You may refer to [Chapter 3](#) to setup the multi-page demo – “vphmi_05” to see how it works.

5.5.1 Level 2 And Level 3 Page

The multi-page name can be any valid html file name. For example, “page2.htm”, “kitchen.htm” , “u2-page4.htm” .

If “u2-“ appear in front of the page name, the page will become a Level 2 page. For example, the “u2-Page4.htm” in the “vphmi_05” demo. If “u3-“ appear in front of the page name, the page will become a Level 3 page. For example, the “u3-time.htm” in the “vphmi_05” demo.

What is a Level2 page? Only users login with the Middle or High priority can get access to it. To access to the Level3 page, users have to login as a High priority user. The page name without “u2-“ and “u3-“ is identified as Level 1 page. That means any user successfully login can access to it. For example, the “main.htm”

The other rules for multi-pages are almost the same as “main.htm” ([section 5.4](#))

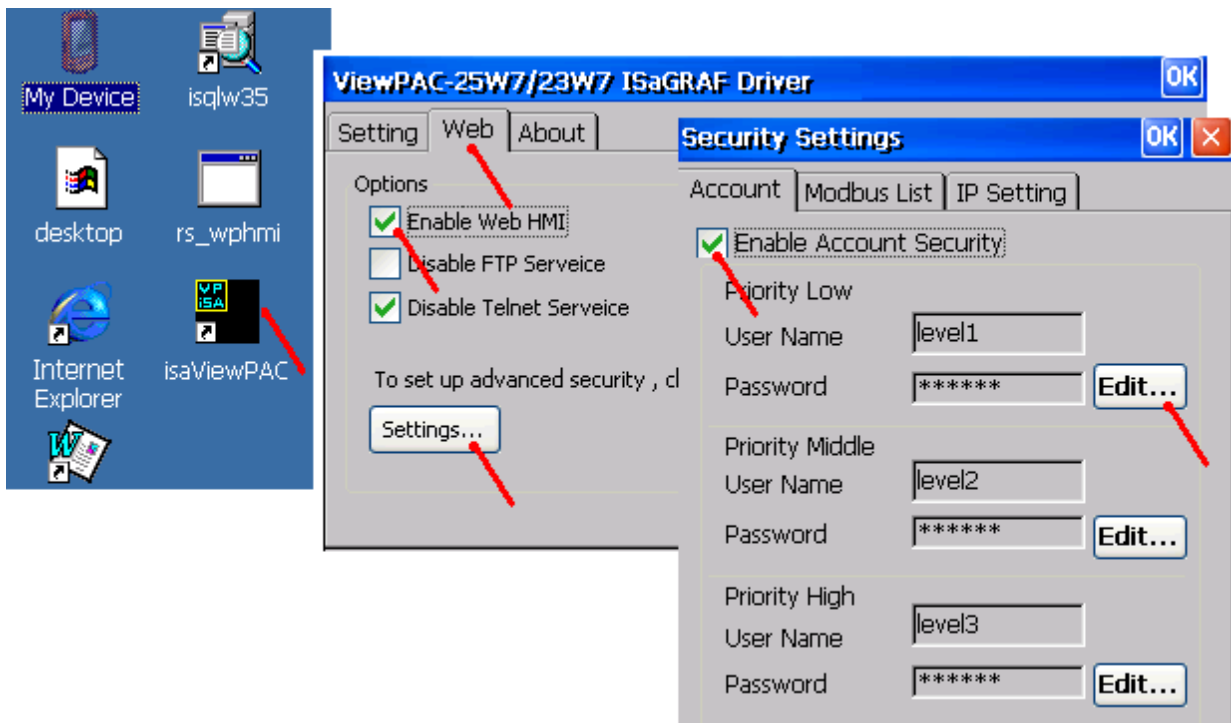

Note: If “Enable Account Security” is not check, any user can easily get access to your ISaGRAF WinCE ViewPAC through the Internet Explorer.

5.5.2 Switch One Page To One Another Page

Please take a look at the “menu.htm” of the “vphmi_05” demo as below. The “goto_R_page()” function can be used for switching to other page.

```
<!-- top_or_left=0 , scrolling=0 , width=110 , resize=1 -->

<html>
<head>
<title>Title1</title>
<meta http-equiv="Content-Type" content="text/html; charset=big5" >
<SCRIPT LANGUAGE="JavaScript" src="./msg/wincon.js"></SCRIPT>

<SCRIPT LANGUAGE="JavaScript">
function start1()
{
  A_11();
}

function refresh_data()
{
  if(run_at_pc==1) return; // if simulate at the PC, just return
}
</SCRIPT>
</head>
<body onload="start1()">

<!-- Logout button -->
<form name="form_logout" method="post" action="./login.dll">
  <input style="cursor:hand" name="CMD" type="submit" value="Logout" onClick="return
logout(this.form)">
</form>
<br/>
<br/>

<!-- Goto main.htm -->
<A style="cursor:hand" onClick="goto_R_page('main.htm')">第 1 頁</A>
<br/>
<br/>

<!-- Goto kitchen.htm -->
<A style="cursor:hand" onClick="goto_R_page('kitchen.htm')">Kitchen</A><br/>
<br/>
<br/>
...
```

“cursor:hand” will display the mouse arrow as a hand when entering the button area.

Switch page to “main.htm”

Switch page to “kitchen.htm”

5.6 Web Security

There are some ways user can get access to the ViewPAC via its Ethernet port.

1. Using Modbus TCP protocol at port No.= 502. (ISaGRAF and other HMI can do this)
2. Using ftp (for example, keyin “ftp://10.0.0.103” on the Internet Explorer)
3. Using telnet (for example, keyin “telnet 10.0.0.103 in the “command” window)
4. Using the Web server (The Web HMI does)

For safety, recommend to disable item 2 and 3 at run time.

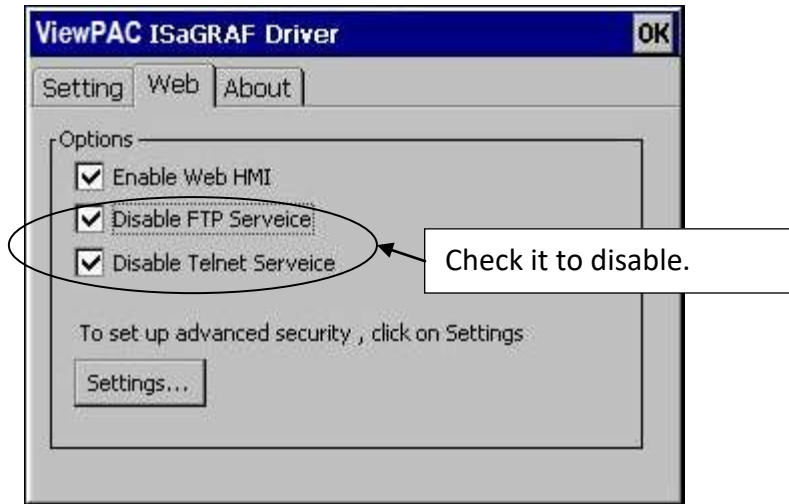

And about item 4, please set proper username & password for the Web HMI.

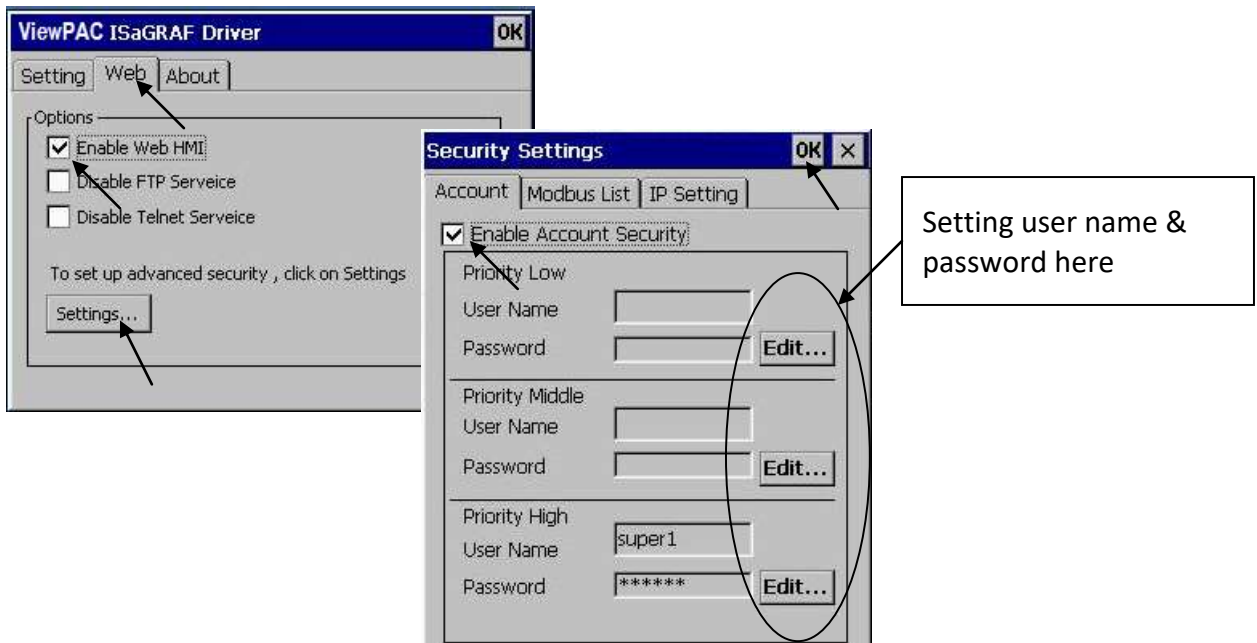

About item 1, user may set up to eight IP address for ISaGRAF or other HMI to get access to the ISaGRAF WinCE ViewPAC via the Modbus TCP/IP protocol as below.

On the I/O connection window of ISaGRAF. Please connect “vip” and entering the IP which can get access to the ViewPAC via Modbus TCP/IP protocol. If “vip” is not connected, any remote IP can get access to your ViewPAC via Modbus TCP/IP protocol. If “vip” is connected and No IP is entered (all assigned as “N/A”), No HMI and ISaGRAF can get access to it anymore.

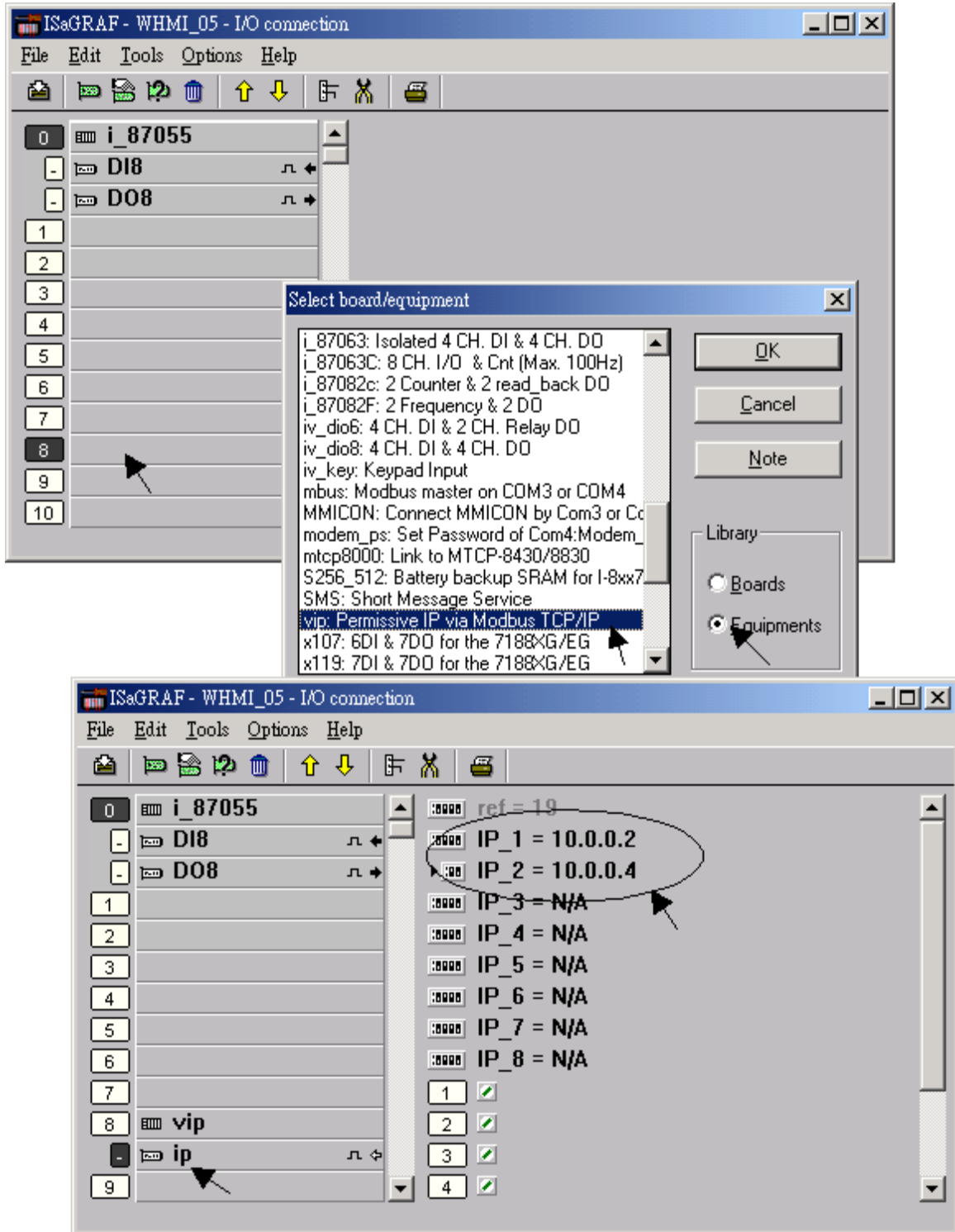

Please re-compile your ISaGRAF project and download it to the controller if you have modified the IO connection.

Chapter 6 VB.NET 2008 Program Access To ISaGRAF Variables

Important Notice:

Please store your application programs and data files in the \Micro_SD . Don't store them in the \System_disk. That is because the \System_Disk is using Nor Flash memory. Its size is small and major purpose is for storing OS, ISaGRAF driver, some basic utilities and DLL . The Nor Flash memory is not good for frequently updating files. If update files frequently in the \System_Disk (for example, update a file every 1 to 5 seconds, then it will be about ten thousand more updates in one day), the data or files in the \System_disk may crush or lost for some days or months later.

This chapter lists the procedure for creating the first demo program by Visual Studio .NET 2008 development tool. There is some sample programs in the ISaGRAF WinCE ViewPAC CD-ROM

ISaGRAF WinCE ViewPAC CD-ROM :

\napdos\isagraf\vp-25w7-23w7\vb.net-2008-demo

wp_vb01 : Digital I/O demo with one I-87055W in slot 0 of the ViewPAC.

wp_vb02 : Analog I/O demo with one I-87024W in slot 1 and one I-8017HW in slot 2.

wp_vb03 : Read / Write ISaGRAF internal integers, timers and real variables. (No I/O)

The related ISaGRAF demo project name are "wp_vb01.pia" , "wp_vb02.pia" and "wp_vb03.pia" in the same directory.

6.1 Create a New Project

1. In the first, users need to open Microsoft Visual Studio .NET 2008 software. And then in the menu of "File", please run the "New Project" .

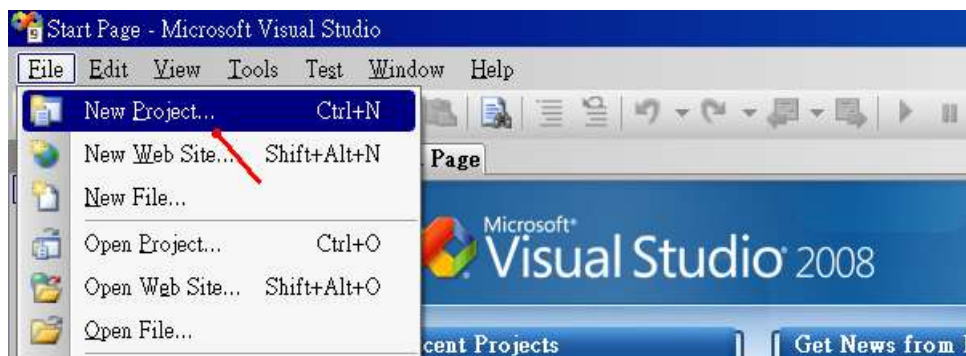

2. Check the "Smart Device" on the left, then selecting the ".NET frame work 2.0" and "Smart Device Project". Then entering a proper project name and the last click on "OK".

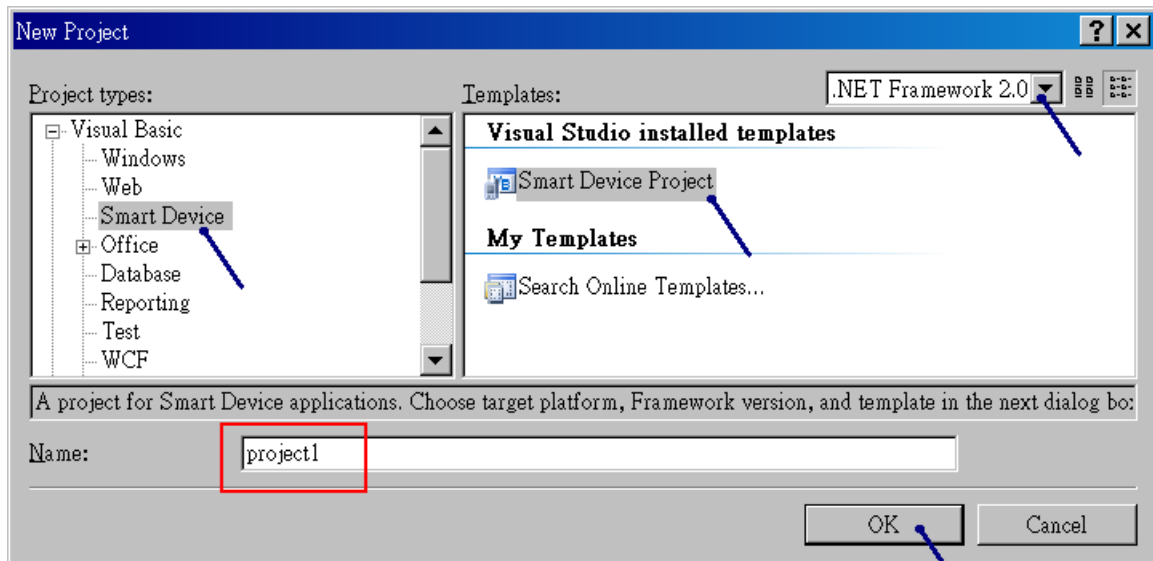

3. Select the "Device Application" and "Windows CE" and ".NET Compact Framework Version 2.0", then click on "OK".

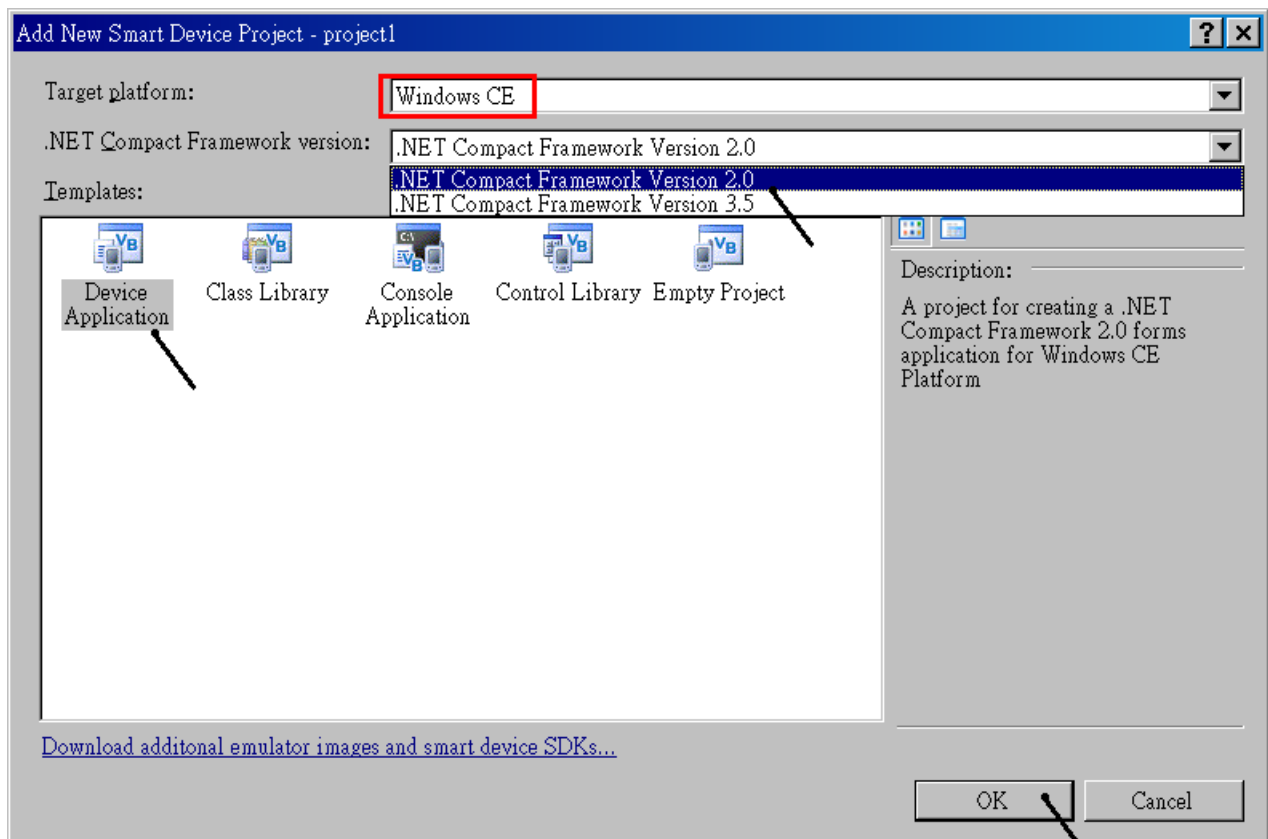

6.2 Add Project Reference for an Application

The “QuickerNet” library contains all modules’ functions. Before you use the “Quicker” keyword in the program, you must add the “QuickerNet.dll” into the reference list of your application.

1. Right click on the Project name on the right hand side, then select “Add Reference”.

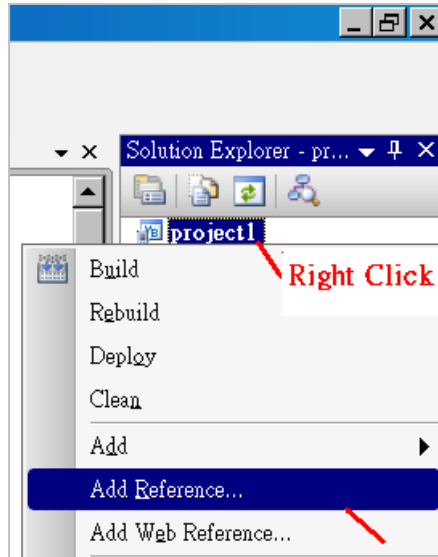

2. Select the “mscorlib” in the list box and click the button “OK” (the component “mscorlib” must appear in the Selected Components area)

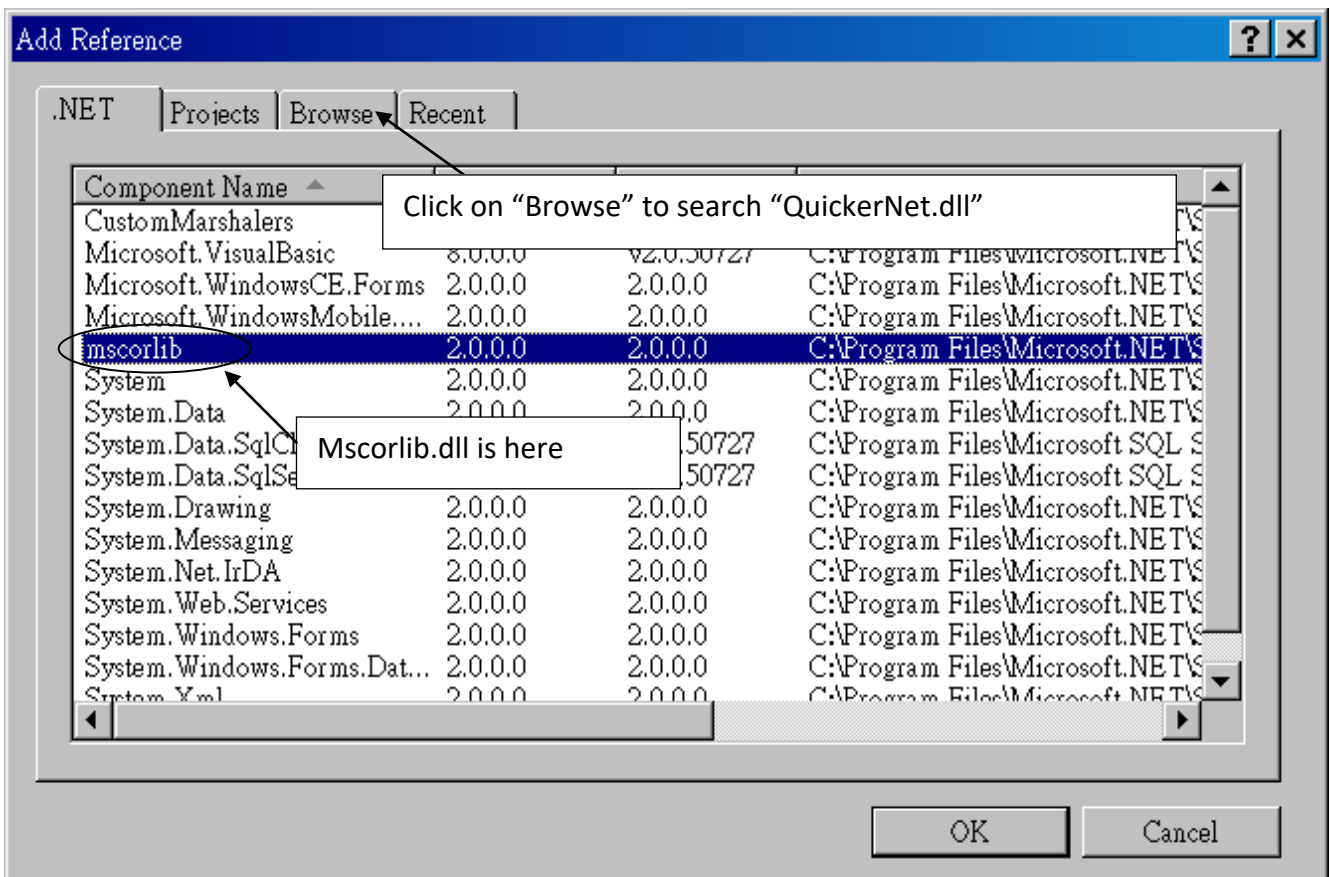

- Click the “Browse” button. Select the “QuickerNet.dll” from **VP-2xW7/4xx7 CD-ROM : napdos\isagraf\vp-25w7-23w7\vb.net-2008-demo\wp_vb01\vb01** subfolder or from your own location.

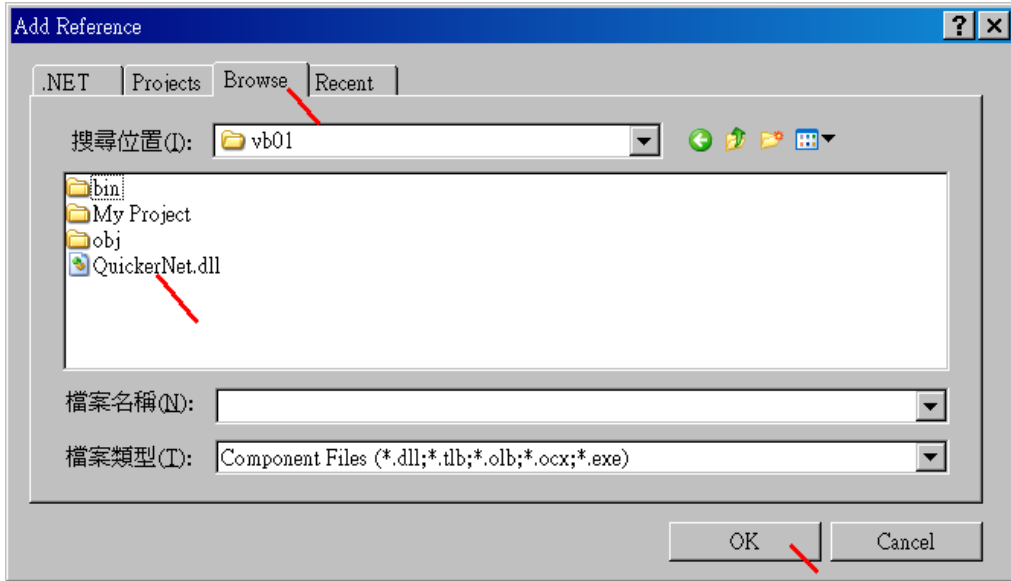

- When both “mscorlib” and “QuickerNet.dll” are added, please double click on “My Project” to check if the “QuickerNet.dll” is well added.

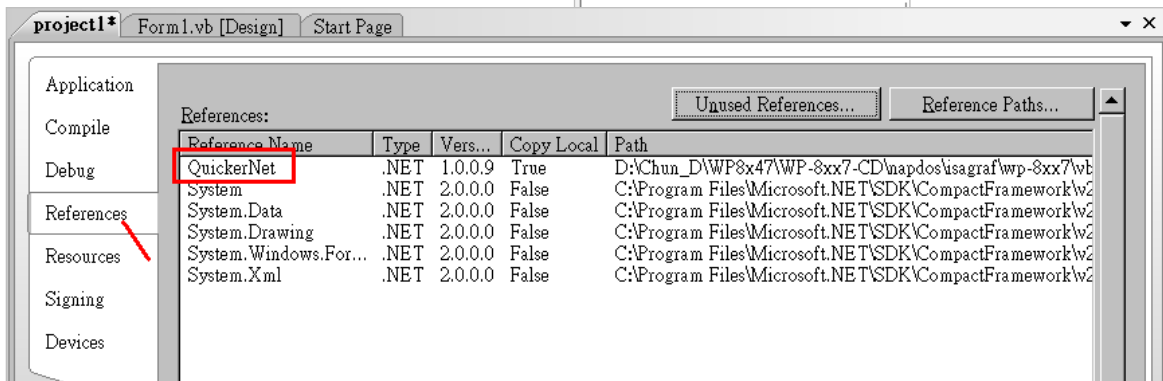
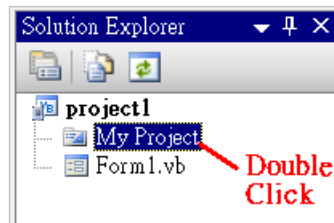

- Right-click on the “Form1.vb” and select “View Code” from the pop-up. Move cursor to top and insert the “Option Explicit On” and “Imports Quicker” in the first two statements.

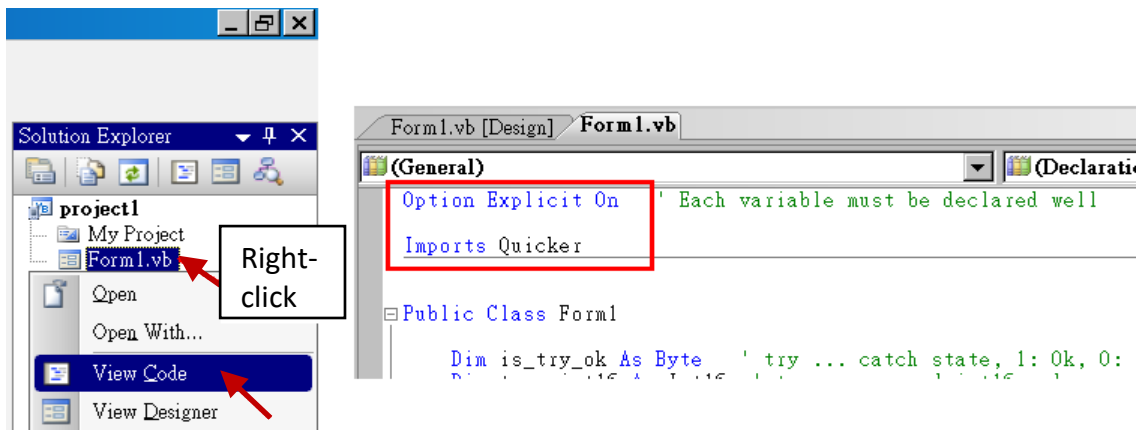

Then you can design all required objects and actions inside your VB Forms.

6.3 Compiling an Application Program

When you have finished writing a program, you can build an application by the following steps.

1. Remember to save at any time for safety.

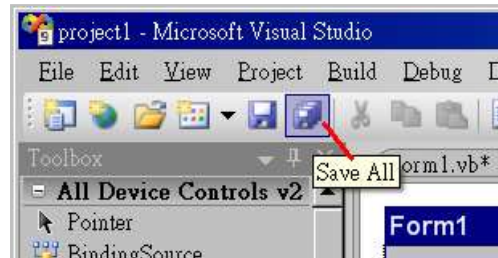

2. Then compile (Build) the project. The result is listed in the "Error List" windows at the bottom.

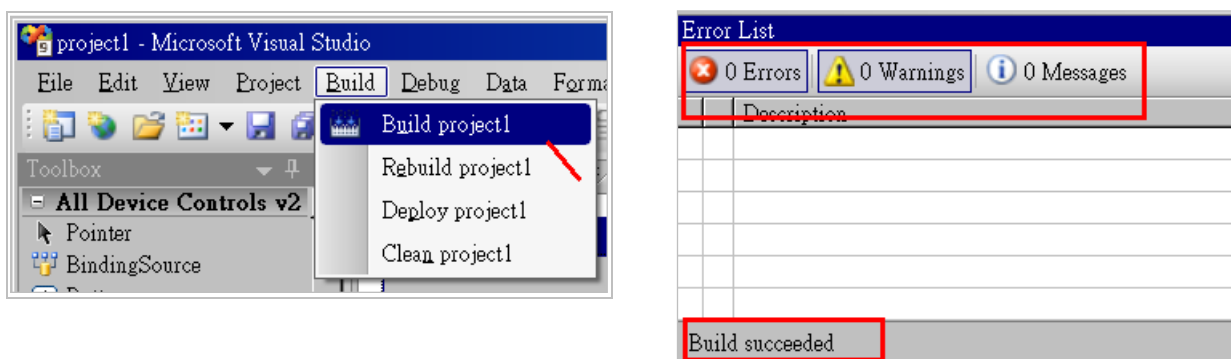

3. You can find the execution file in

<Your VB.net Project folder> \bin\Release\ <project_name>.exe

Please copy this execution file to the ViewPAC's \System_Disk\ISaGRAF\ path to run it.

Note:

User may copy the VB.NET execution file to other path to run it but there should contain at least three DLL files with it or it can not run correctly.

For ex, the project1.exe can run in the \Micro_SD\ path if there is three plus one file in it.

The "project1.exe", "QuickerNet.dll", "Quicker.dll" and "Mscorlib.dll". (The "QuickerNet.dll" , "Quicker.dll" and "Mscorlib.dll" can be copied from the ViewPAC's "\System_disk\ISaGRAF\" path)

6.4 QuickerNET.DLL

This section we will focus on the description of the application example of QuickerNET.DLL functions. There are some functions that can be used to R/W data from/to the ISaGRAF SoftLogic. The functions of QuickerNET.DLL can be clarified as two groups as depicted as below:

1. Digital R/W Functions
2. Analog R/W Functions

6.4.1 Digital R/W Functions

■ UserSetCoil

Description:

This function is to set the value to a Boolean variable by Modbus network address.

Syntax:

`UserShare.UserSetCoil (iUserAddress As System.UInt16, iStatus As byte)`

Parameter:

iUserAddress : Specify the Modbus Network Address of Variable (1 to 8191) iStatus : Set the status. For instance, iStatus = 1 for True, iStatus = 0 for False

Return Value:

None

Example:

' Set the output variable of Modbus Network Address "1" to True.
UserShare.UserSetCoil(Convert.ToUInt16(1), 1)

Demo program :

ISaGRAF WinCE ViewPAC CD-ROM: \napdos\isagraf\vp-25w7-23w7\vb.net-2008-demo\wp_vb01

■ UserGetCoil

Description:

This function is to get the value from a Boolean variable by Modbus network address.

Syntax:

```
UserShare.UserGetCoil ( iUserAddress As System.UInt16, ByRef iStatus As byte)
```

Parameter:

iUserAddress : Specify the Modbus Network Address of Variable (1 to 8191)

iStatus : Get the variable status , iStatus = 1 for True, iStatus = 0 for False

Return Value:

None

Example:

' Get the variable status of Network Address "1".

Dim iStatus As Byte

UserShare.UserGetCoil(Convert.ToUInt16(1), iStatus)

Demo program :

ISaGRAF WinCE ViewPAC CD-ROM: \napdos\isagraf\vp-25w7-23w7\vb.net-2008-demo\wp_vb01

6.4.2 Analog R/W Functions

■ [UserSetReg_short](#) ■ [UserSetReg_long](#) ■ [UserSetReg_float](#)

Description:

These functions are to set 16-bit short integer , 32-bit long integer & 32-bit float value to the specified Modbus network address.

Syntax:

```
UserShare.UserSetReg_Short (ByVal iUserAddress As System.UInt16, ByRef iStatus As Integer) As Byte
```

```
UserShare.UserSetReg_Long (ByVal iUserAddress As System.UInt16, ByRef iStatus As Integer) As Byte
```

```
UserShare.UserSetReg_Float (ByVal iUserAddress As System.UInt16, ByRef iStatus As Single) As Byte
```

Parameter:

iUserAddress : Specify the Network Address of Variable (1 to 8191)

iStatus : Set the short or long integer or float value.

Example:

' Set a long value "1234567" to the variable of Modbus Network Address "1".

```
UserShare.UserSetReg_long(Convert.ToUInt16(1), Convert.ToInt32(1234567) )
```

' Set a short value "-1234" to the variable of Modbus Network Address "3".

```
UserShare.UserSetReg_short(Convert.ToUInt16(3), Convert.ToInt16(-1234) )
```

' Set a float value "2.174" to the variable of Modbus Network Address "4".

```
UserShare.UserSetReg_float(Convert.ToUInt16(4), Convert.ToSingle(2.174) )
```

Demo program :

ISaGRAF WinCE ViewPAC CD-ROM:

- \napdos\isagraf\vp-25w7-23w7\vb.net-2008-demo\wp_vb02 for R/W analog I/O
- \napdos\isagraf\vp-25w7-23w7\vb.net-2008-demo\wp_vb03 for R/W internal long integer, Timer and Real (floating-point) values.

Note:

The long integer & timer & real variable's Network Address No. must occupy 2 No. in the ISaGRAF project. (refer to [section 4.2](#) of "User's Manual of ISaGRAF Embedded Controllers" or in the CD-ROM: \napdos\isagraf\vp-25w7-23w7\english-manu\ "User_Manual_I_8xx7.pdf")

Description:

These functions are to get 16-bit short integer, 32-bit long integer & 32-bit float value from the specified Modbus network address.

Syntax:

```
UserShare. UserGetReg_Short (ByVal iUserAddress As System.UInt16, ByRef iStatus As Integer) As Byte
```

```
UserShare. UserGetReg_Long (ByVal iUserAddress As System.UInt16, ByRef iStatus As Integer) As Byte
```

```
UserShare. UserGetReg_Float (ByVal iUserAddress As System.UInt16, ByRef iStatus As Single) As Byte
```

Parameter:

iUserAddress : Specify the Network Address of Variable (1 to 8191)

iStatus : Get the short or long integer or float value.

Example:

```
Dim float_val As Single
```

```
Dim short_val As Int16
```

```
Dim long_val As Int32
```

' Get float value of the variable of Modbus Network Address "7".

```
UserShare.UserGetReg_float(Convert.ToUInt16(7), float_val)
```

' Get long value of the variable of Modbus Network Address "9".

```
UserShare.UserGetReg_long(Convert.ToUInt16(9), long_val)
```

' Get short value of the variable of Modbus Network Address "11".

```
UserShare.UserGetReg_short(Convert.ToUInt16(11), short_val)
```

Demo program :

ISaGRAF WinCE ViewPAC CD-ROM:

- \napdos\isagraf\vp-25w7-23w7\vb.net-2008-demo\wp_vb02 for R/W analog I/O
- \napdos\isagraf\vp-25w7-23w7\vb.net-2008-demo\wp_vb03 for R/W internal long integer, Timer and Real (floating-point) values.

Note:

The long integer & timer & float variable's Network Address No. must occupy 2 No. in the ISaGRAF project. (refer to [section 4.2](#) of "User's Manual of ISaGRAF Embedded Controllers" or in the CD-ROM: \napdos\isagraf\vp-25w7-23w7\english-manu\ "User_Manual_I_8xx7.pdf")

Chapter 7 EVC++ Program Access To ISaGRAF Variables

Important Notice:

Please store your application programs and data files in the \Micro_SD . Don't store them in the \System_disk. That is because the \System_Disk is using Nor Flash memory. Its size is small and major purpose is for storing OS, ISaGRAF driver, some basic utilities and DLL . The Nor Flash memory is not good for frequently updating files. If update files frequently in the \System_Disk (for example, update a file every 1 to 5 seconds, then it will be about ten thousand more updates in one day), the data or files in the \System_disk may crush or lost for some days or months later.

User can write his EVC++ 4.0 application to access to the ISaGRAF variables running at the same VP-2xW7/4xx7 by using the below functions for Read/Write Boolean, word, long and float value.

The include file and library at design time are "WinConAgent.h" and "Quicker.lib". (ISaGRAF WinCE ViewPAC CD-ROM: \napdos\isagraf\vp-25w7-23w7\evc++-lib\). The DLL at run time is the "Quicker.dll" which is in ViewPAC's \System_Disk\isagraf\ (Please copy the execution file after successfully compilation to the ViewPAC 's \System_Disk\isagraf\ and then run it.)

Set boolean value:

```
unsigned char UserSetCoil(unsigned short iUserAddress, unsigned char iStatus);
```

iUserAddress:1 to 8191 (Variable's network address in ISaGRAF project)

iStatus: 0: set boolean to False, 1: set boolean to True

for ex. UserSetCoil(100 , 1) // set Boolean at network addr 100 as True

Set word or float or long value:

```
unsigned char UserSetReg(unsigned short iUserAddress, long *iStatus, unsigned char iDType);
```

iUserAddress:1 to 8191 (Variable's network address in ISaGRAF project)

iStatus: A pointer to a long type, which stores the data to set

iDType 0: type is word

1: data type is float

2: data type is long (use long for Timer value in ISaGRAF, unit is ms)

for ex.

```
float float_val;
```

```
long word_val, long_val;
```

```
long *temp_val;
```

```
// set word_val (-32768 to +32767) to ISaGRAF variable with network address 1
```

```
word_val = -20000 ;
```

```
temp_val = (long *)&word_val;
```

```
UserSetReg(1 , temp_val, 0);
```

```
// set float_val to ISaGRAF variable with network address 2
```

```
float_val = 1.2345 ;
```

```
temp_val = (long *)&float_val;
```

```
UserSetReg(2 , temp_val, 1);
```

```
// set long_val to ISaGRAF variable with network address 4
```

```
long_val = 12345678 ;
```

```
temp_val = (long *)&long_val;
```

```
UserSetReg(4 , temp_val, 2);
```

Get boolean value:

```
unsigned char UserGetCoil(unsigned short iUserAddress, unsigned char *iStatus);
```

iUserAddress: 1 to 8191 (Variable's network address in ISaGRAF project)
 iStatus: 0: boolean is False, 1: boolean is True

for ex.

```
unsigned char bVal;
UserGetCoil(5, &bVal) // get Boolean value at network addr 5
```

Get word or float or long value:

```
unsigned char UserGetReg(unsigned short iUserAddress, long *iStatus,
                        unsigned char iDType);
```

iUserAddress: 1 to 8191 (Variable's network address in ISaGRAF project)
 iStatus: A pointer to a long type, which stores the data returned
 iDType 0: type is word
 1: data type is float
 2: data type is long (use long for Timer value in ISaGRAF, unit is ms)

for ex.

```
float float_val;
long word_val, long_val;
long ret_val;

// get word_val (-32768 to +32767) of ISaGRAF variable with network address 10
UserGetReg(10, &ret_val, 0);
if (ret_val >= 0 && ret_val <= 32767) word_val = ret_val;
else word_val = ret_val | 0xFFFF0000;

// get float of ISaGRAF variable with network address 11
UserGetReg(11, &ret_val, 1);
float_val = *(float *) (&ret_val);

// get long of ISaGRAF variable with network address 13
UserGetReg(13, &ret_val, 2);
long_val = ret_val;
```

Note:

The long integer, timer and float variable's Network Address No. must occupy 2 No. in the ISaGRAF project.

(Please refer to [section 4.2](#) of "User's Manual of ISaGRAF Embedded Controllers" or in the ISaGRAF WinCE ViewPAC CD-ROM:

```
\\napdos\isagraf\vp-25w7-23w7\english-manu\User_Manual_I_8xx7.pdf")
```

Chapter 8 InduSoft Project Access To ISaGRAF Variables

Note:

If the HMI program behavior is not so smooth or slow, please refer to [Appendix F](#).

**** The ISaGRAF WinCE ViewPAC in this manual include: (abbreviation: VP-2xW7/4x7)**
VP-25W7, VP-23W7, VP-4137 (Support ISaGRAF logic running in the PAC)
VP-25W6, VP-23W6, VP-4136 (Support InduSoft & ISaGRAF logic running in the same PAC)

1. Please always set a **fixed IP** address to the ISaGRAF WinCE ViewPAC. (**No DHCP**). Recommend to use the NS-205/208 or RS-405/408 Industrial Ethernet Switch for them.
2. Please refer to ISaGRAF WinCE ViewPAC CD-ROM: \napdos\isagraf\vp-25w7-23w7\english-manu\ "user_manual_i_8xx7.pdf" for detailed ISaGRAF English User's Manual.

A simple example to run InduSoft & ISaGRAF logic in the same controller:

Step 1: Create a new ISaGRAF project.

This demo uses a DI/DO module I-87055W in slot 0 of VP-25W6 PAC , and an AO module I-87024W in slot 2 and one internal variable defined as follow.

ISaGRAF Variable Definition:

Variable Type	Name	Network Address	Comment	Attributes
Boolean	DI_1	1	87055W DI channel 1	Input
Boolean	DO_1	11	87055W DO channel 1	Output
Integers	AO_1	21	87024W AO channel 1	Output
Integers	Internal	31	Internal variable	Internal

If you are not familiar with ISaGRAF, please refer to [section 4.1](#) to [4.3](#).

I/O Connection Setting:

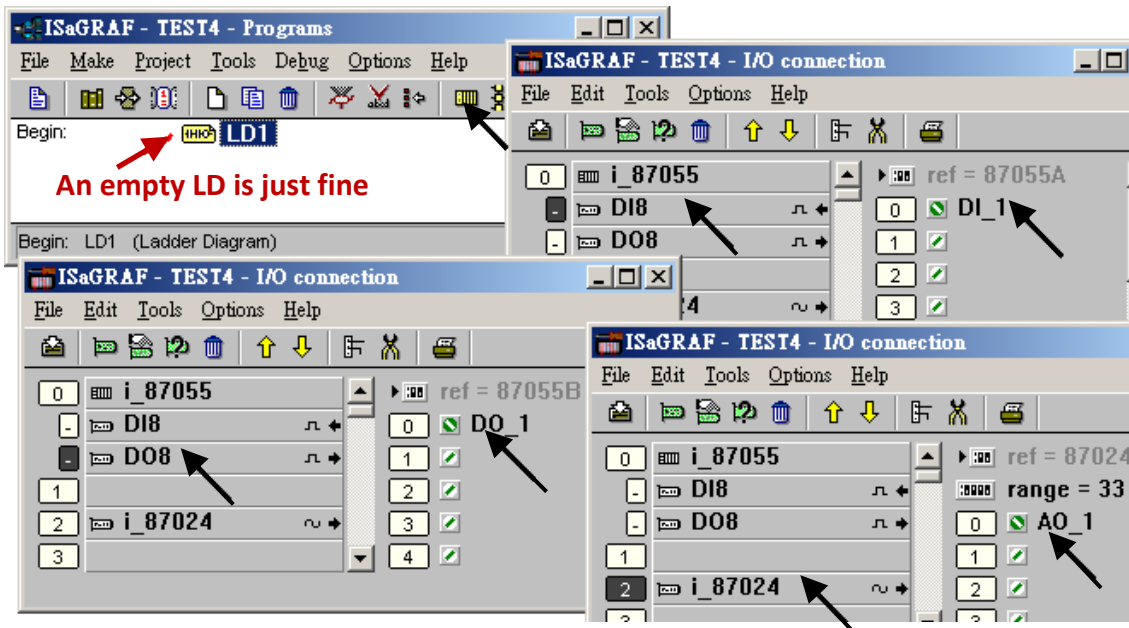

The ISaGRAF variables to be exchanged with InduSoft must be declared with a Modbus “Network Address” as below.

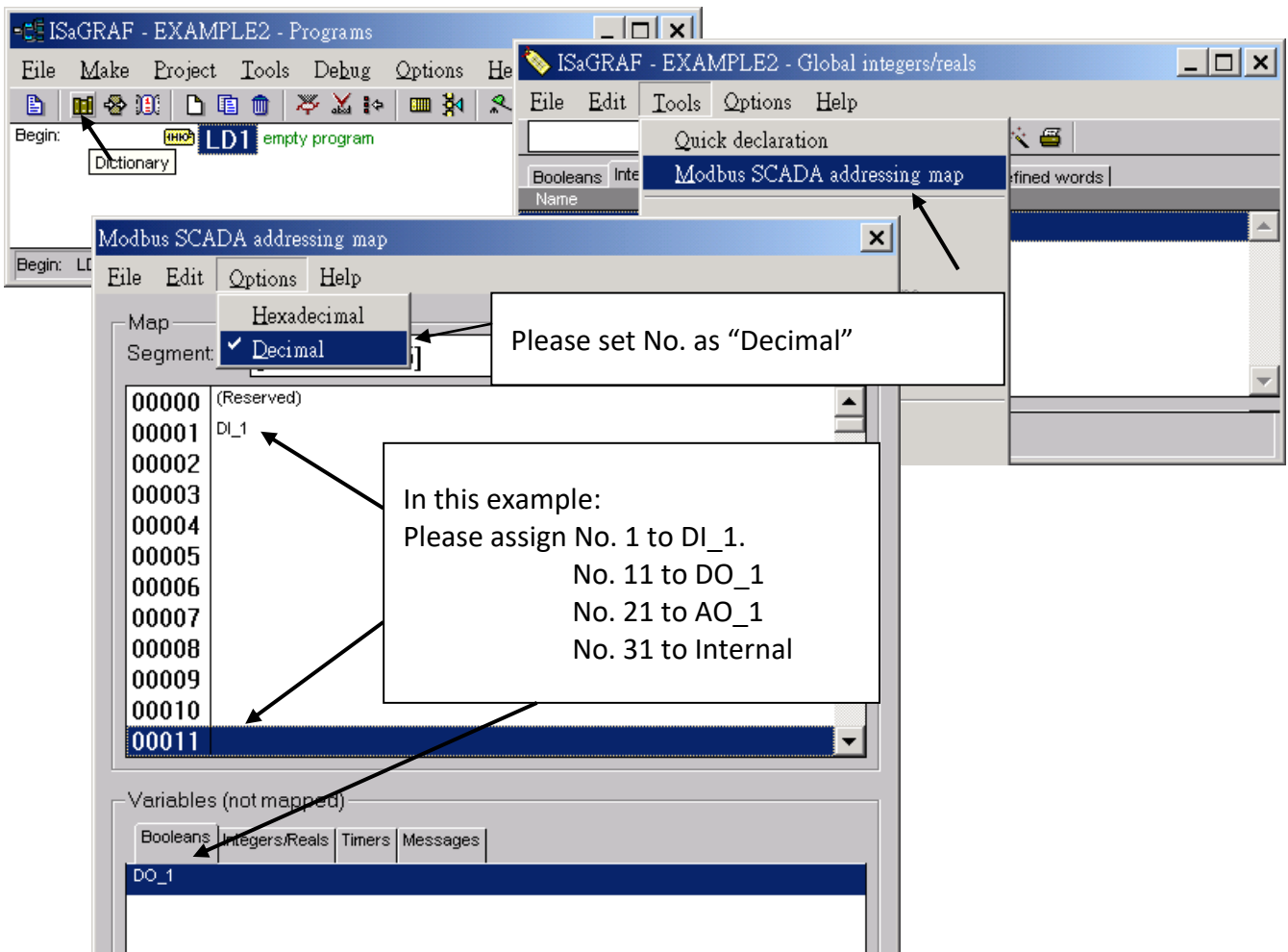

Please save & compile the ISaGRAF example project & then download to the PAC. If you are not familiar with ISaGRAF, please refer to [section 4.1](#) to [4.3](#).

Step 2: Create an InduSoft project.

1. Select [File] > [New] from the “InduSoft Web Studio” main menu.
2. Click on “Project” tab in the “New” window. Then type in the name for the new user’s project in the “Project name” and select “Windows Embedded Lite” in the “Product type”. Press “OK”.
3. The “Project Wizard” window will appear. Select “Empty Application” on the “Template”, “320 x 240” on the “Resolution” and “None” on the “Shared Tags”.
4. Then, the new project will show on the “Project Explorer” window as the figure.

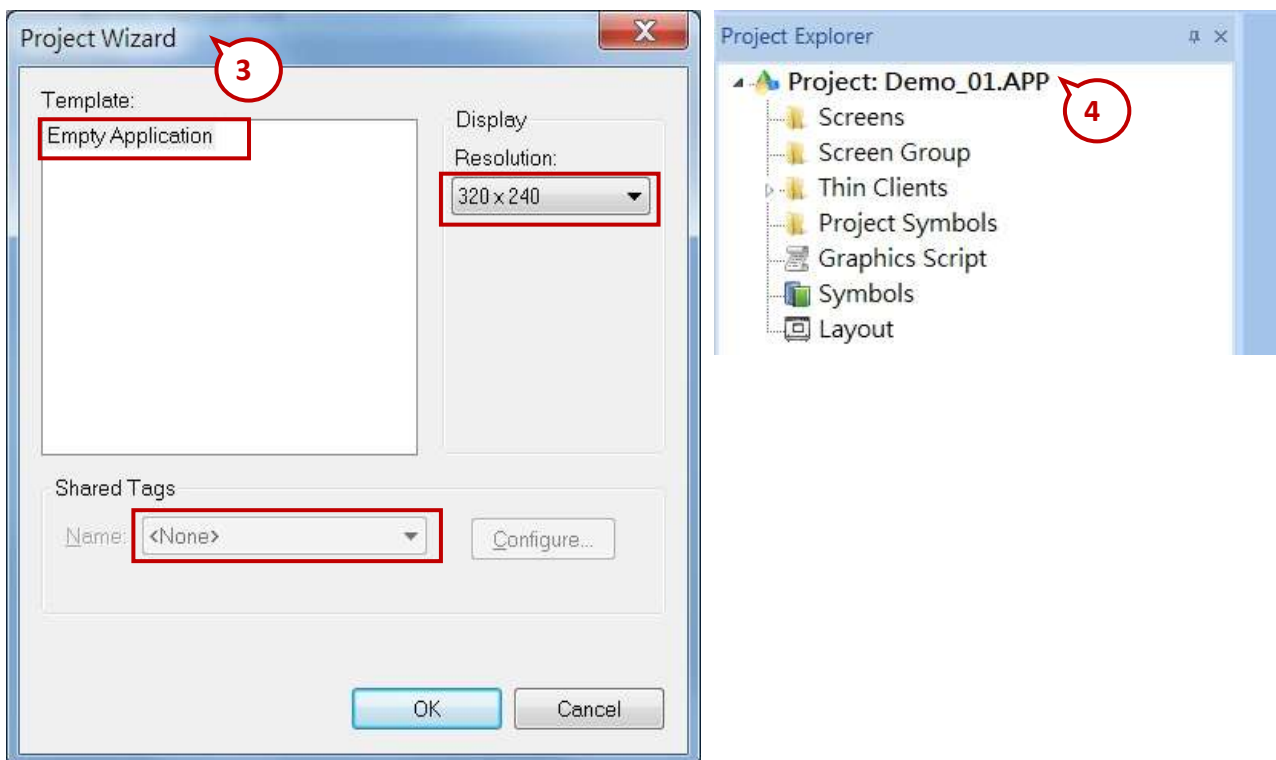
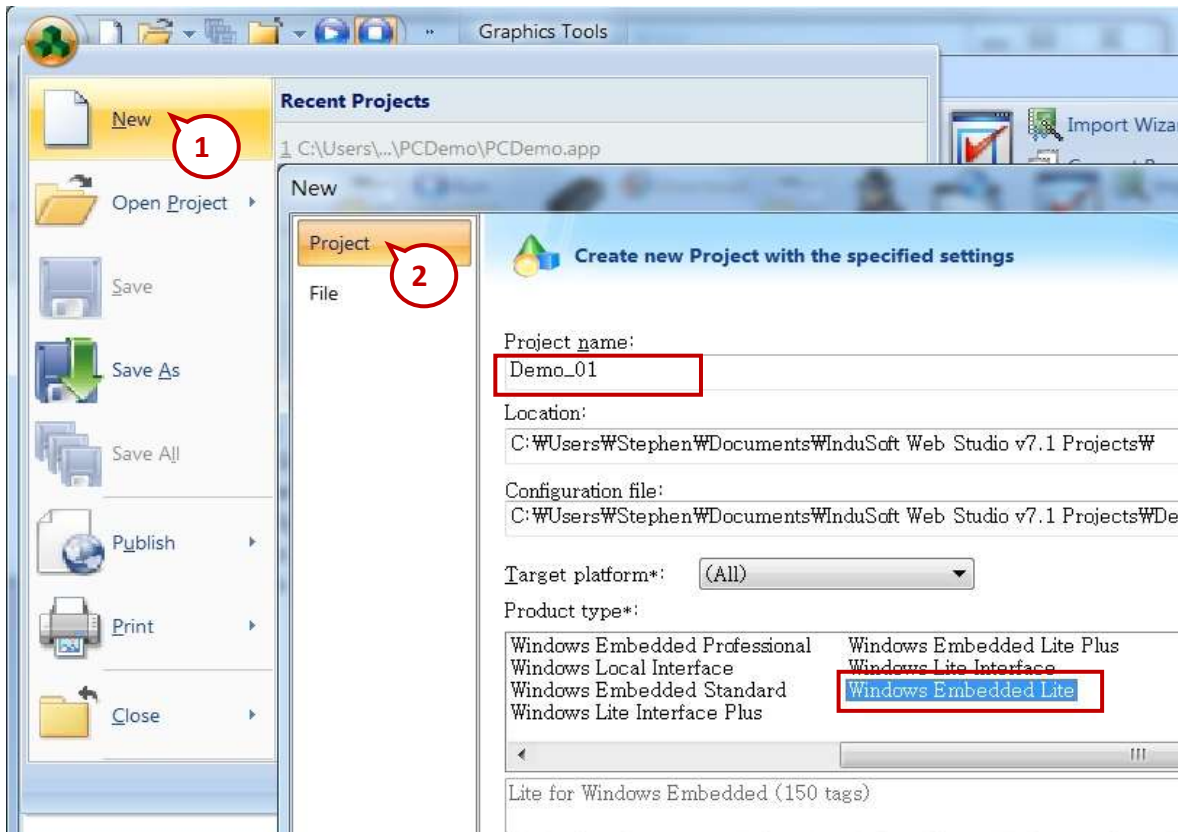

Define application tags

Select [Insert] > [Tag] on the main menu bar

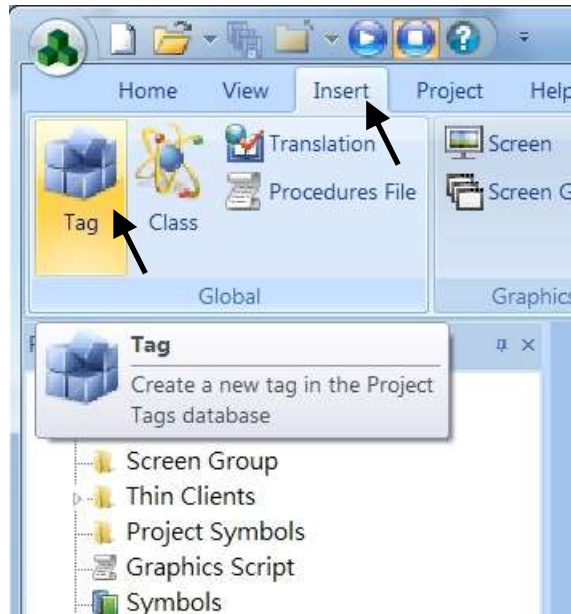

The “New Tag” window will show as below.

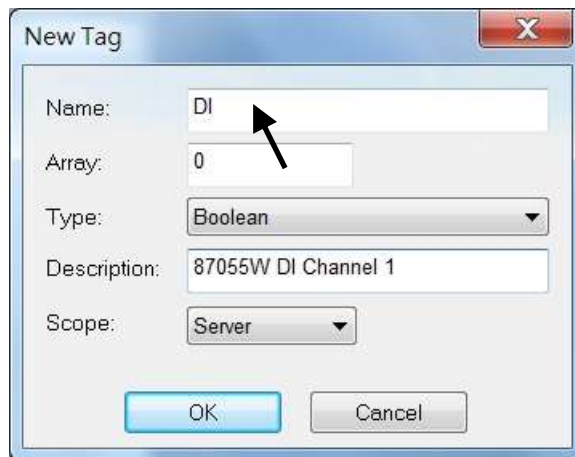

This demo uses a DI/DO module I-87055W, an AO module I-87024W and one internal variable defined as follow. Please create these tags one by one.

Project Tags					
	Name	Array	Type	Description	Scope
1	DI	0	Boolean	87055W DI Channel 1	Server
2	DO	0	Boolean	87055W DO Channel 1	Server
3	AO	0	Integer	87024W AO Channel 1	Server
4	Internal	0	Integer	Internal Tag	Server
*			Integer		Server
*			Integer		Server

Create main screen

1. Select the "Graphics" tab in the "Project Explorer" window.
2. Click mouse right button in the file folder of "Screen" then the "Screen Attributes" window appears.
3. Set up the screen attributes such as "Size", "Location", "Runtime Properties" and "Background Picture" then press "OK" to edit screen.

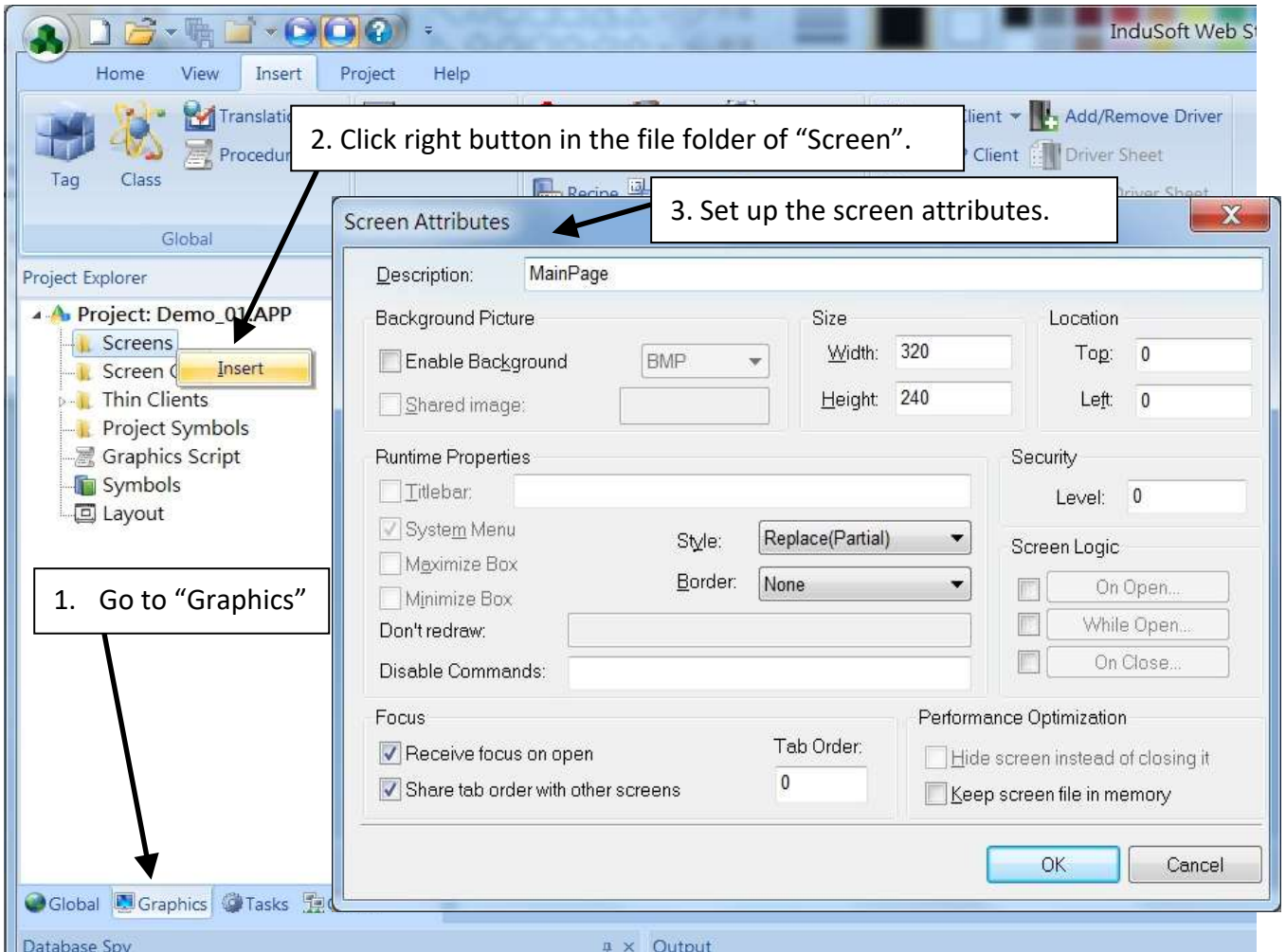

4. Select "Text" icon, then click on the main screen where want to establish a text and type "87055W_DI_1".
5. Select "Text" icon again following the previous text and type "#" then select "Text Data Link".
(# means 1 digit, ##### means 4 digits, ##### means 6 digits)

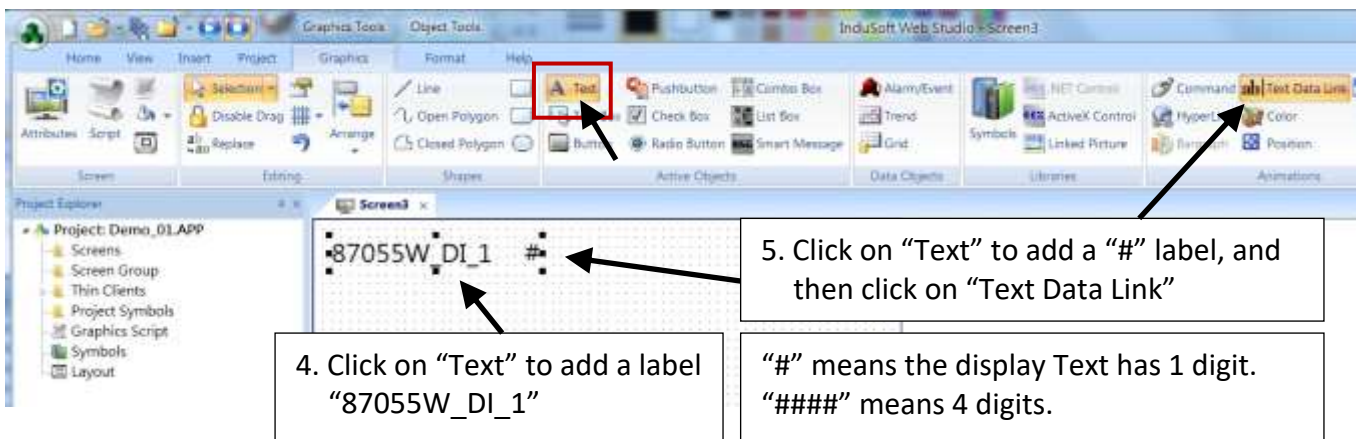

6. Double click the “#” object and then type DI in the “Tag/Expression”.

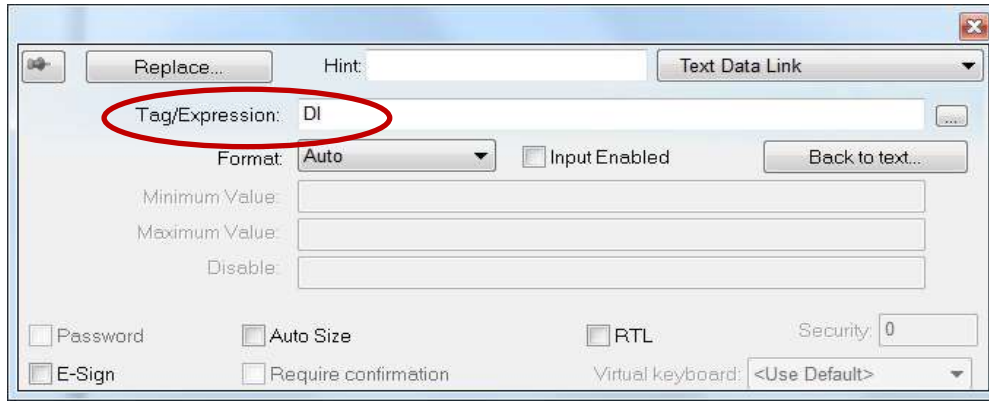

Repeat former method to create other objects and click “Save” icon on the main menu to save this main screen page as “MainPage.scr”. (Select [File] > [Save As HTML] to create this screen that can be visualized in a remote station using a regular web browser.)

Note: For the Output object, as 87024W_AO_1 and 87055W_DO_1, the “Input Enabled” of the “Text Data Link” should be checked as below.

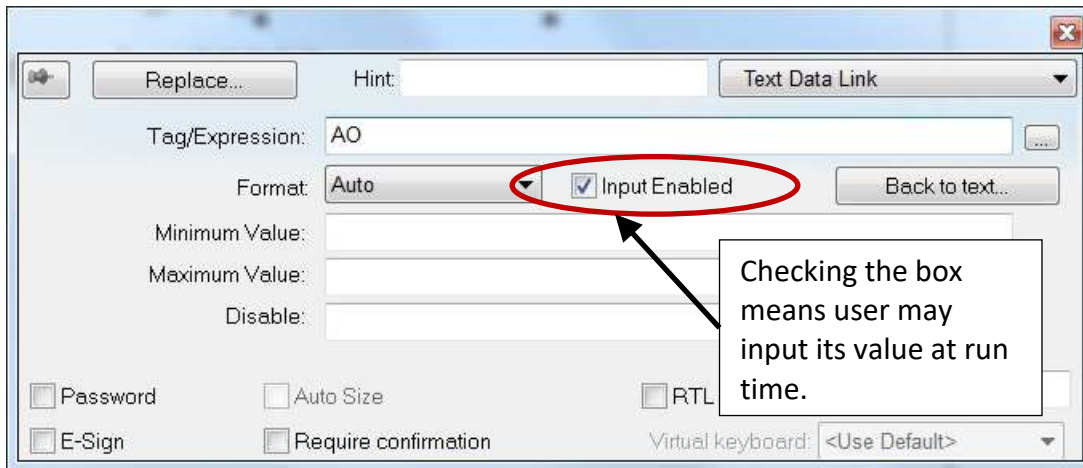

The main screen is created as below.

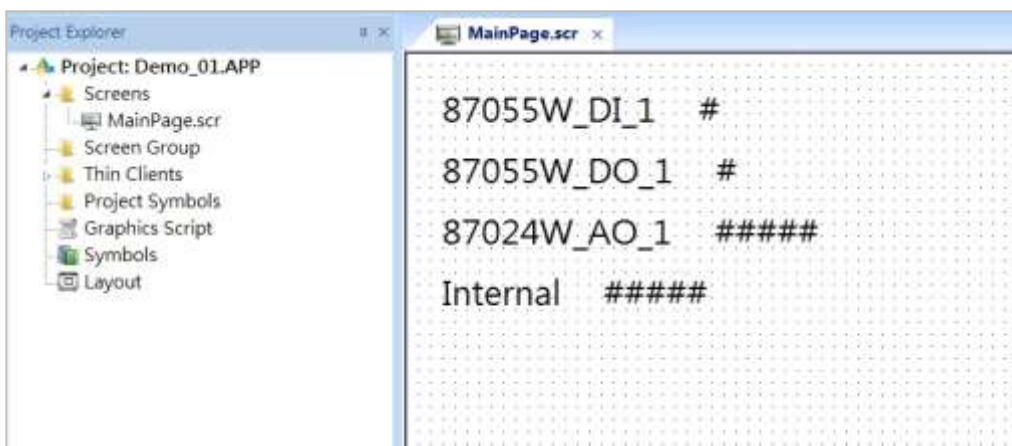

Create Modbus TCP workspace

1. Click “Comm” tab in the “Project Explorer”.
2. Click right mouse button on the folder “Drivers”, and select “Add/Remove drivers”.
3. In the “Communication Drivers” window, click “MOTCP” driver then click “Select” and click “OK” to close this window.

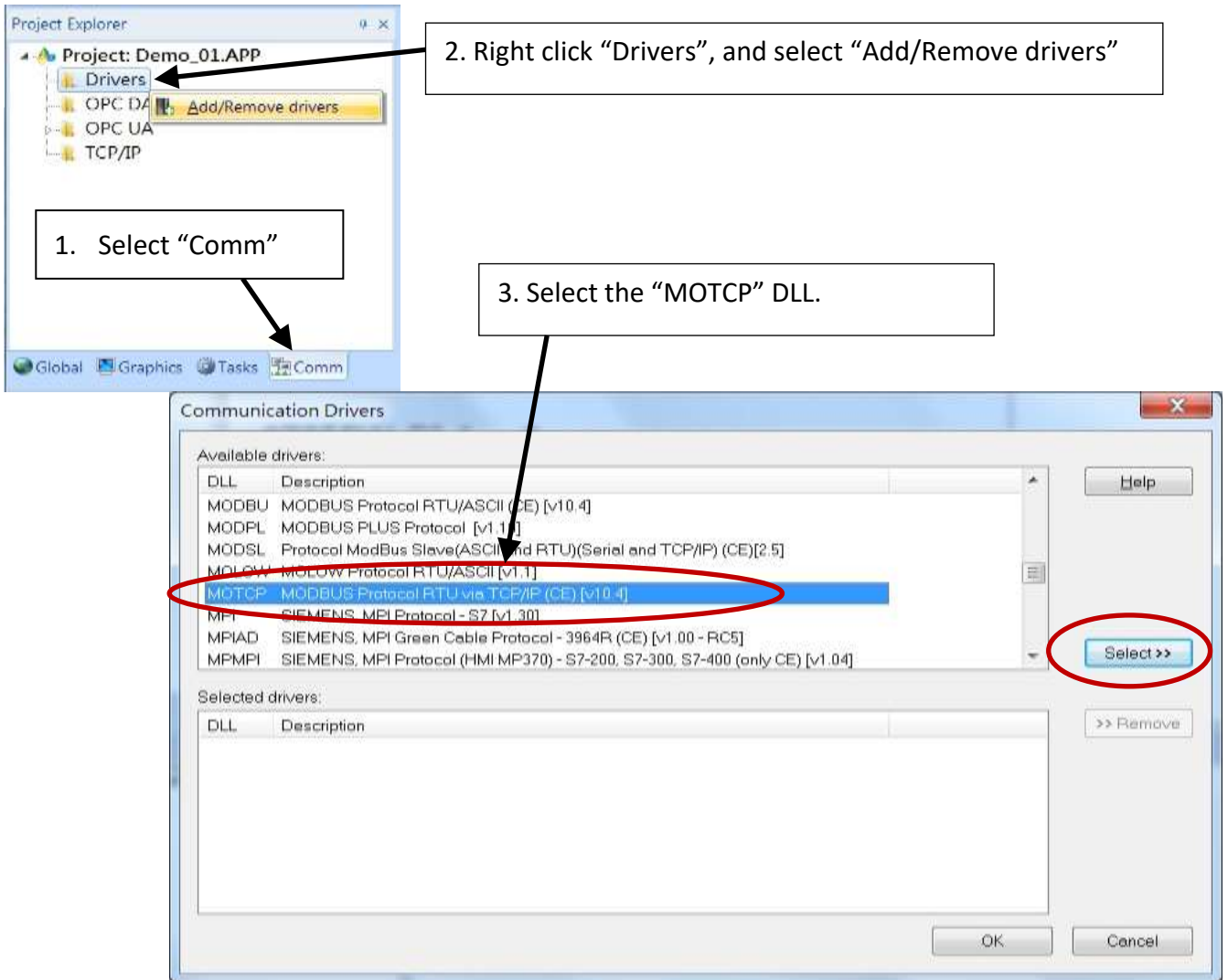

Expanding file folder of “Drivers” and it will show a file folder named “MOTCP”. Click right mouse button and select “Insert” to add a workspace of Modbus TCP.

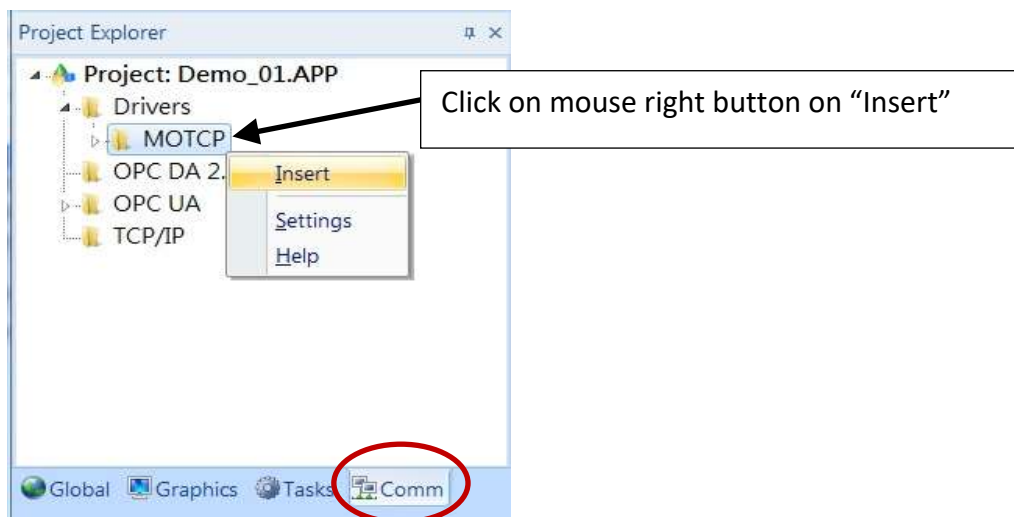

When a **Modbus TCP** workspace “MOTCP001.DRV” appears, fill in following data as corresponding field.

What does “127.0.0.1:502:1” mean ?
 “127.0.0.1” is the local host IP address. It means send data to the same controller. “502” is the Modbus TCP/IP port No. , the last “1” is the Net-ID of the PAC.

Tag Name	Address	Div	Add
1 DI	1		

1X: 0 is for reading “Boolean” data
 0X: 0 is for writing “Boolean” data”
 3X: 0 is for reading short “integer” data (16-bit integer, Word: -32768 to +32767)
 4X: 0 is for writing short “integer” data (16-bit integer , Word: -32768 to +32767)
 DW: 0 is for reading & writing long “integer” (32-bit integer, Double Word)
 FP: 0 is for reading & writing floating point data (32-bit REAL)

For more details, please refer the table as below.

Data Type	Sample Syntax	Valid Range of Initial Addresses per Worksheet	Comments
0X	0X:1	Varies according to the equipment	Coil Status: Read and write events using Modbus instructions 01, 05, and 15
1X	1X:5	Varies according to the equipment	Input Status: Read events using Modbus instructions 02
3X	3X:4	Varies according to the equipment	Input Register: Read events using Modbus instruction 04
4X	4X:5	Varies according to the equipment	Holding Register: Read and write events using Modbus instructions 03, 06, 16
FP	FP:1	Varies according to the equipment	Floating-point value (Holding Register): Read and write float-point values using two consecutive Holding Registers.
DW	DW:2	Varies according to the equipment	32-bit Integer value (Holding Register): Read and write 32-bit integer values using two consecutive Holding Registers.

Please add the following 4 Modbus TCP workspace:

DRV Name	MOTCP001 .DRV	MOTCP002 .DRV	MOTCP003 .DRV	MOTCP004 .DRV
Description	DI	DO	AO	Internal
Station	127.0.0.1:502:1			
Header	1X:0	0X:0	4X:0	3X:0
Tag Name	DI	DO	AO	Interior
Enable Read when Idle	1			1
Enable Write on Tag Change		1	1	
Address	1	11	21	31

When finished all setting, press “Ctrl + F4” to close all inside windows and save all files.

Project Setting

Select “Project -> Settings” to open “Project Settings” window. In the “Startup screen” edit box, fill in “MainPage.scr” then click “OK” to close this window.

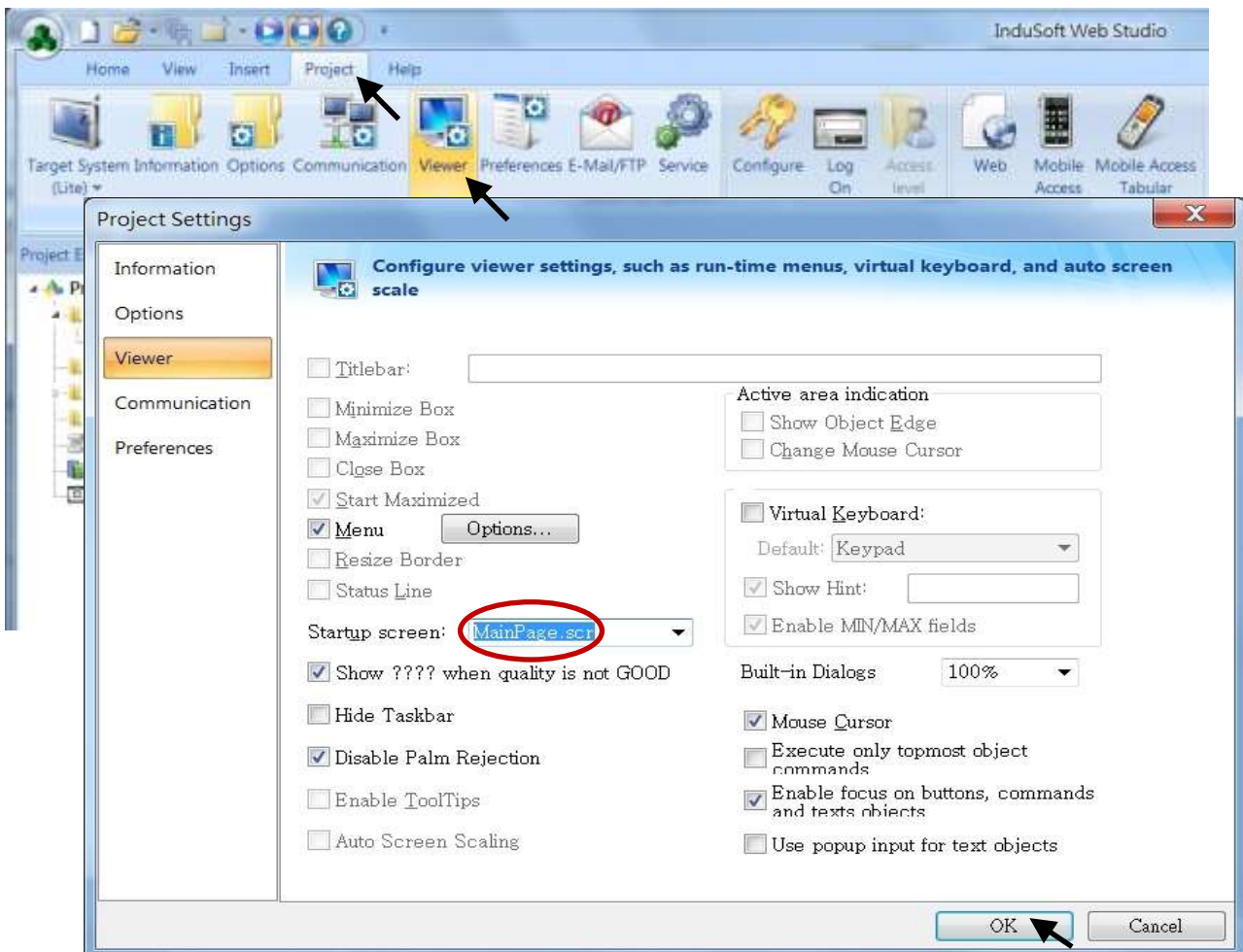

Web Thin Clients

Select “Project -> Settings” to open “Project Settings” window. In the “Data Server IP Address”, type in the correct IP address of your PAC and click “OK”.

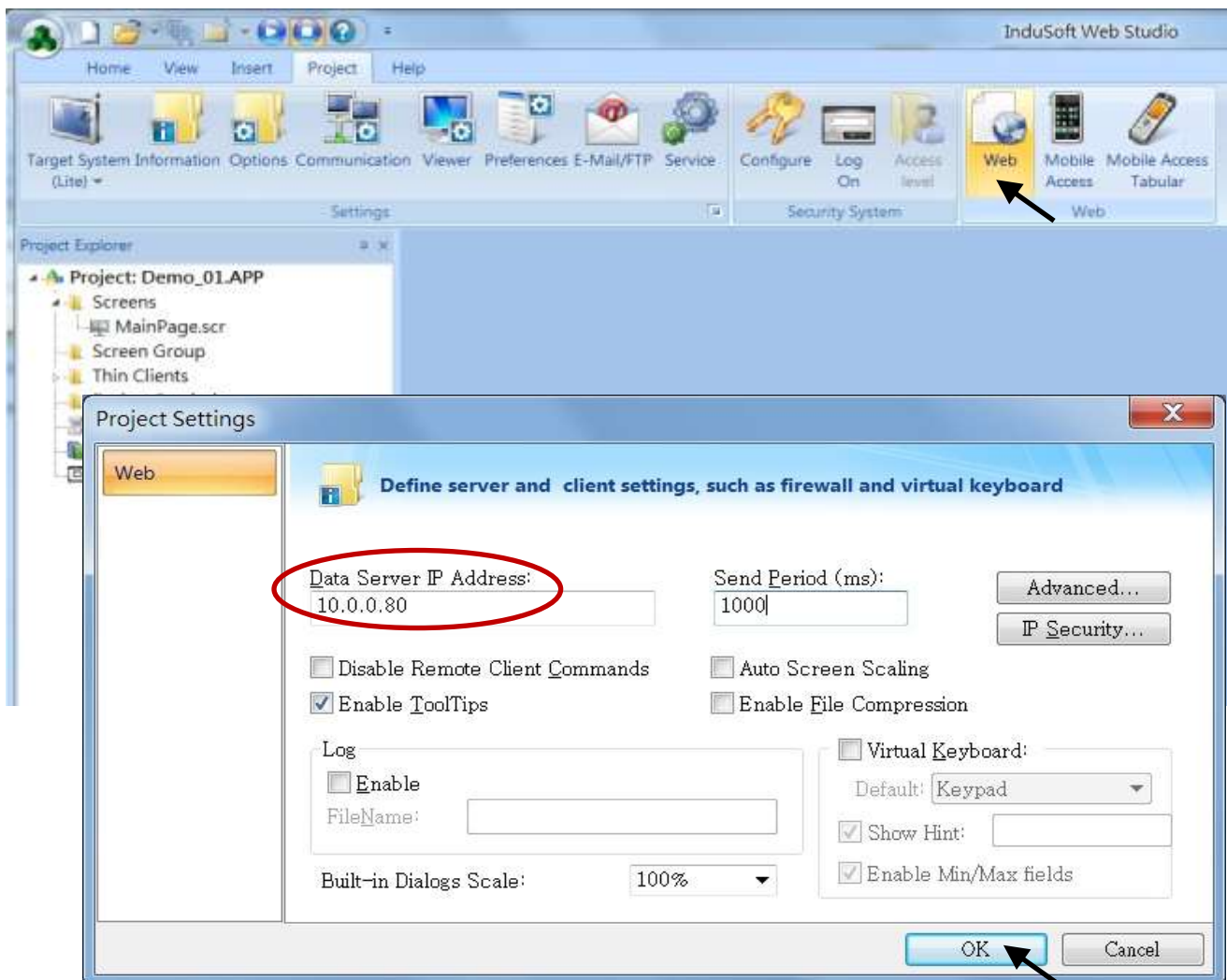

Download and run the project

Select [Home] > [Connect] to open “Remote Management” window. In the “Network IP” of “Target Station”, type in the correct IP address of your PAC and click “Connect”.

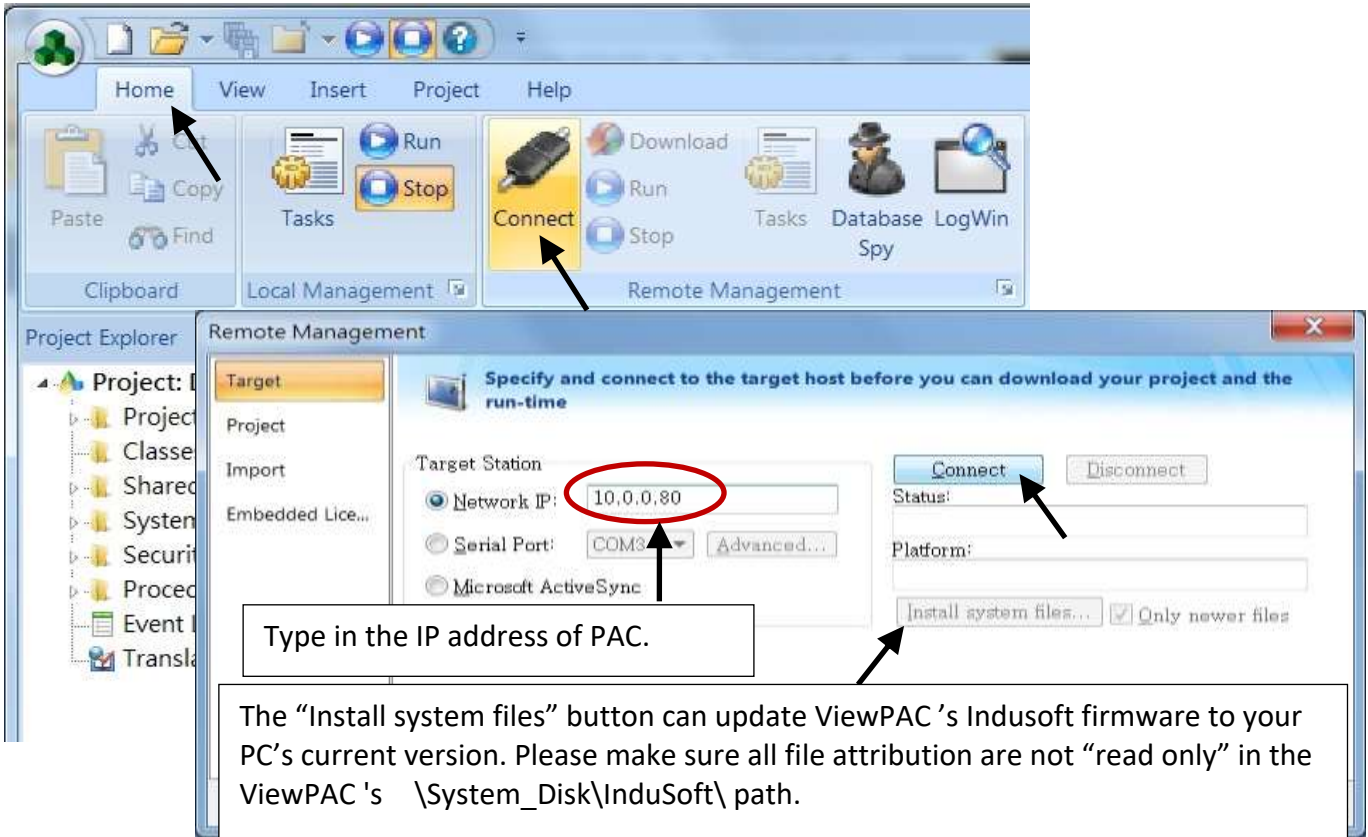

If connection is fine, click on the tab of “Project” then click “Download”. When download finished, click “RUN” to start the project.

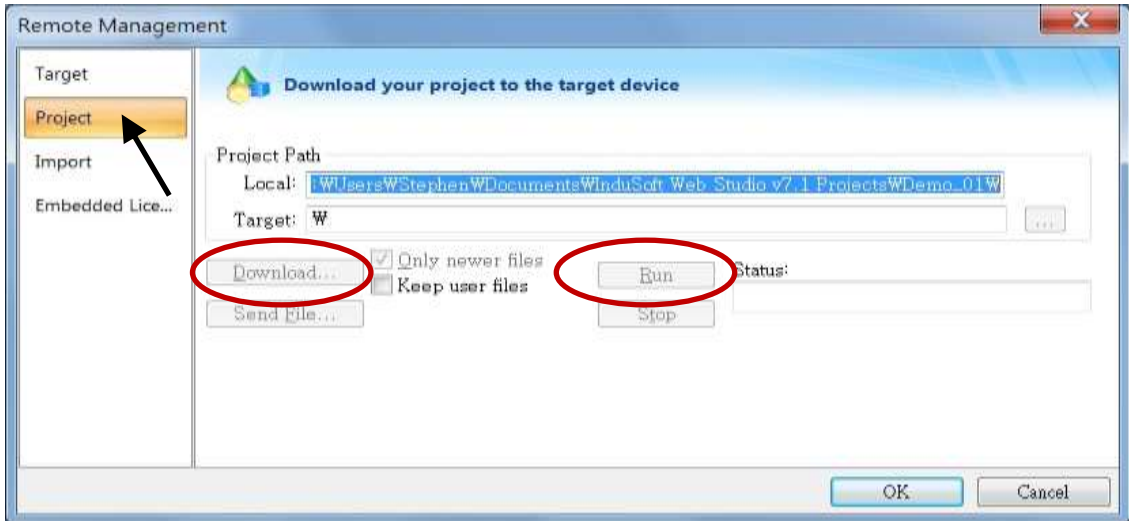

Configuration Web directory of ViewPAC

Run ViewPAC Utility and change Web directory to “\System_Disk\InduSoft\Demo_01\Web”. Click “Setting” and “Save and Reboot” to finish this configuration.

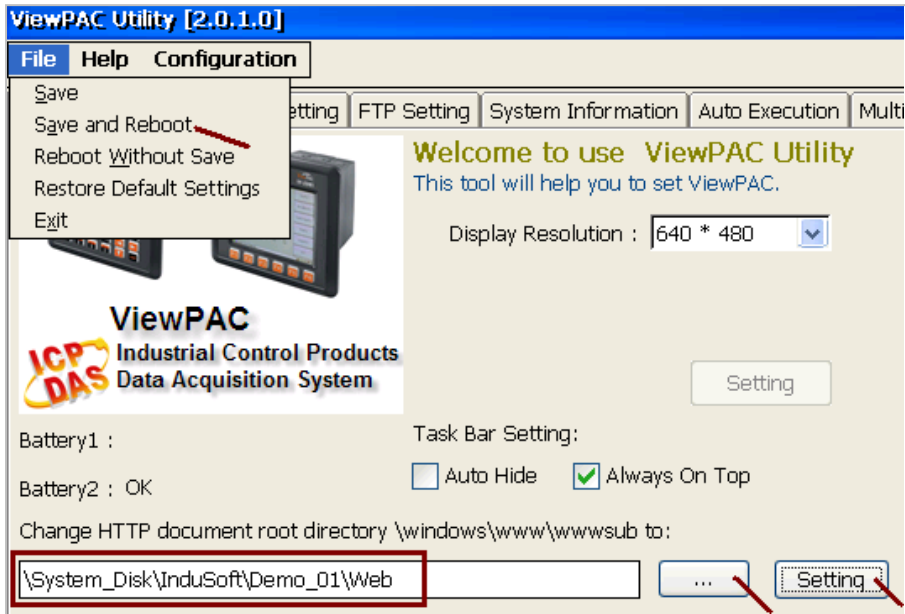

Visualize your project in a remote station

Run Internet Explorer and type for ex. “<http://10.0.0.80/MainPage.html>”. (use ViewPAC 's IP)

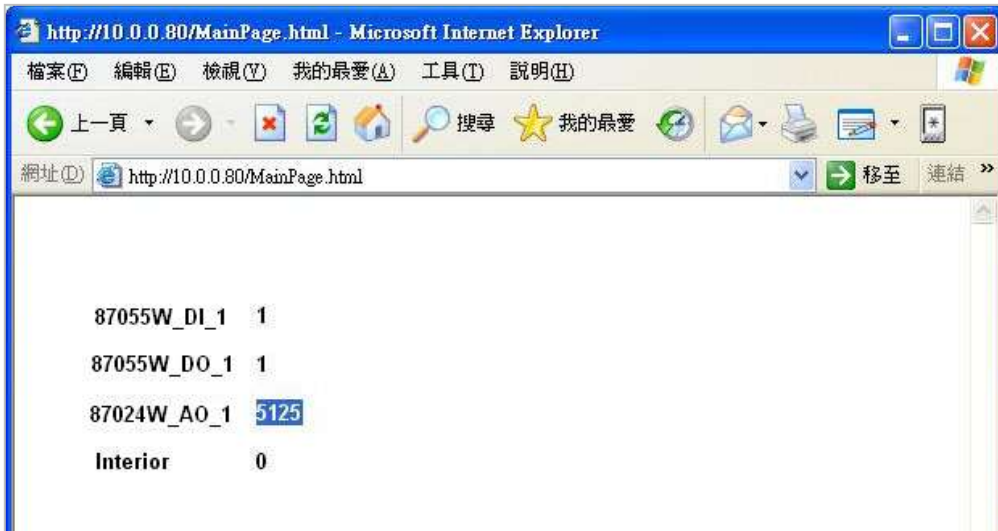

Chapter 9 Example Program & FAQ

**** The ISaGRAF WinCE ViewPAC in this manual include: (abbreviation: VP-2xW7/4xx7)**
VP-25W7, VP-23W7, VP-4137 (Support ISaGRAF logic running in the PAC)
VP-25W6, VP-23W6, VP-4136 (Support InduSoft & ISaGRAF logic running in the same PAC)

Please refer to VP-2xW7/4xx7 CD: \napdos\isagraf\vp-25w7-23w7\english-manu\
"user_manual_i_8xx7.pdf" & "user_manual_i_8xx7_appendix.pdf" for advanced ISaGRAF User's Manual.

9.1 Get On-Line help

If you have question, you may email to service@icpdas.com.

On-line help of ISaGRAF standard functions & function blocks:

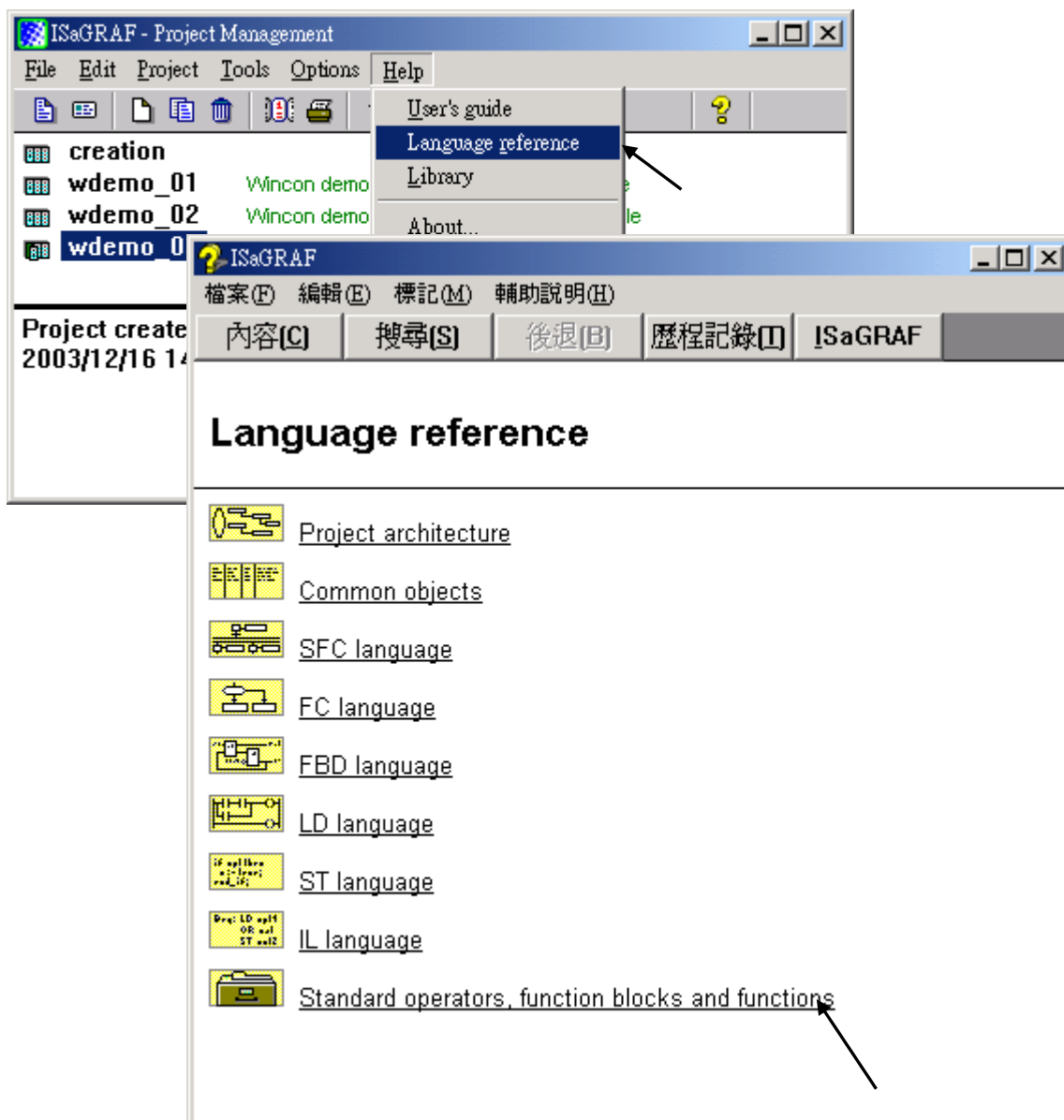

On-line help of ICP DAS add-on functions & function blocks:

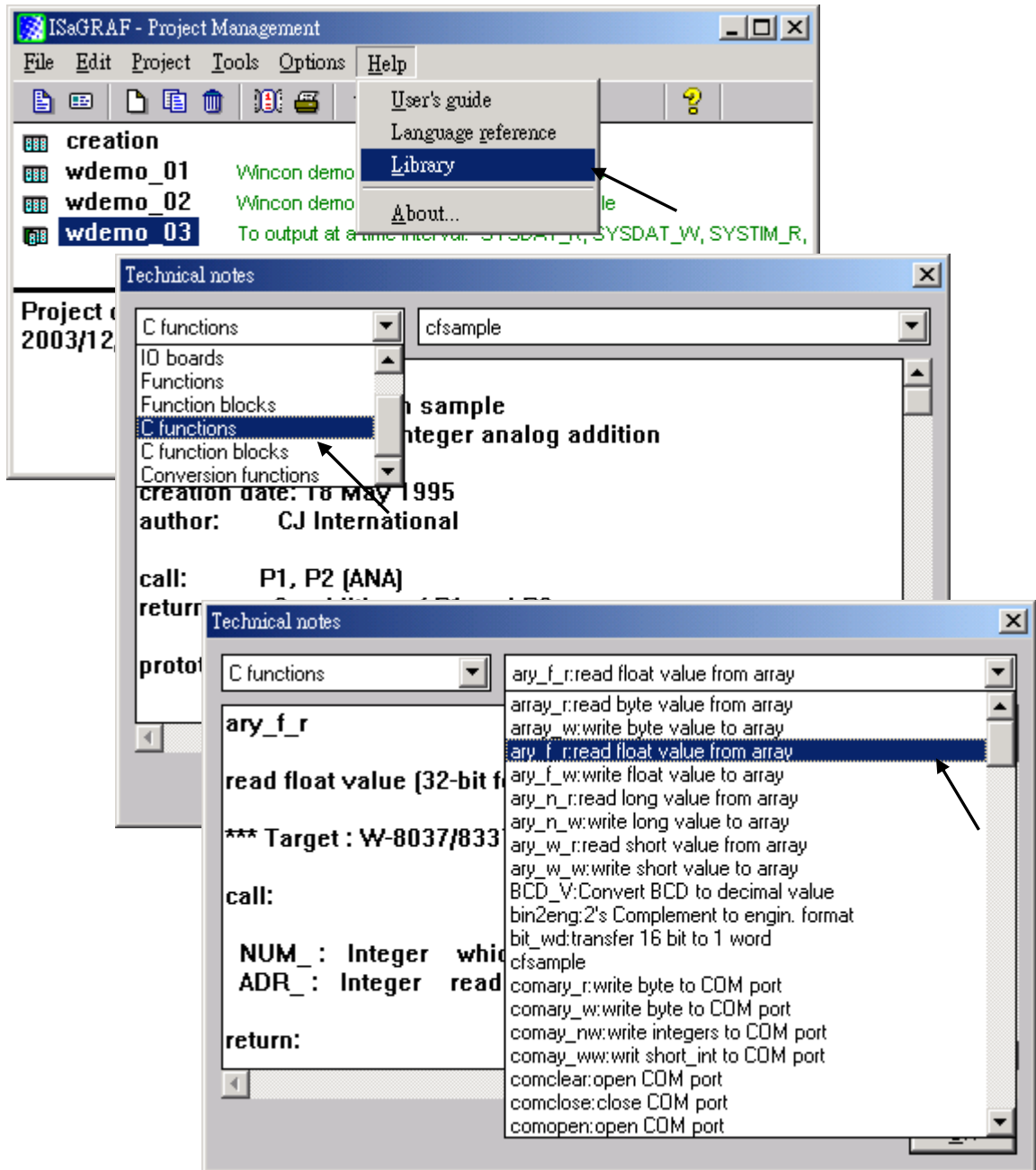

On-line help of ICP DAS add-on I/O boards & I/O complex equipments:

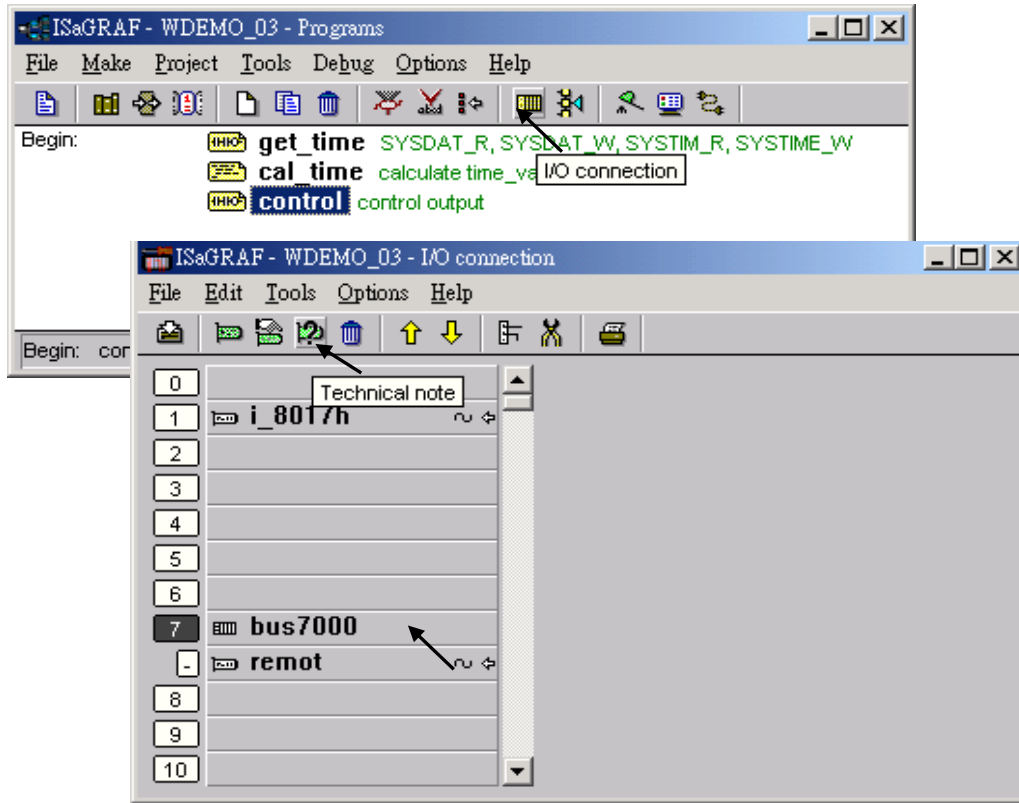

On-line help of ISaGRAF languages:

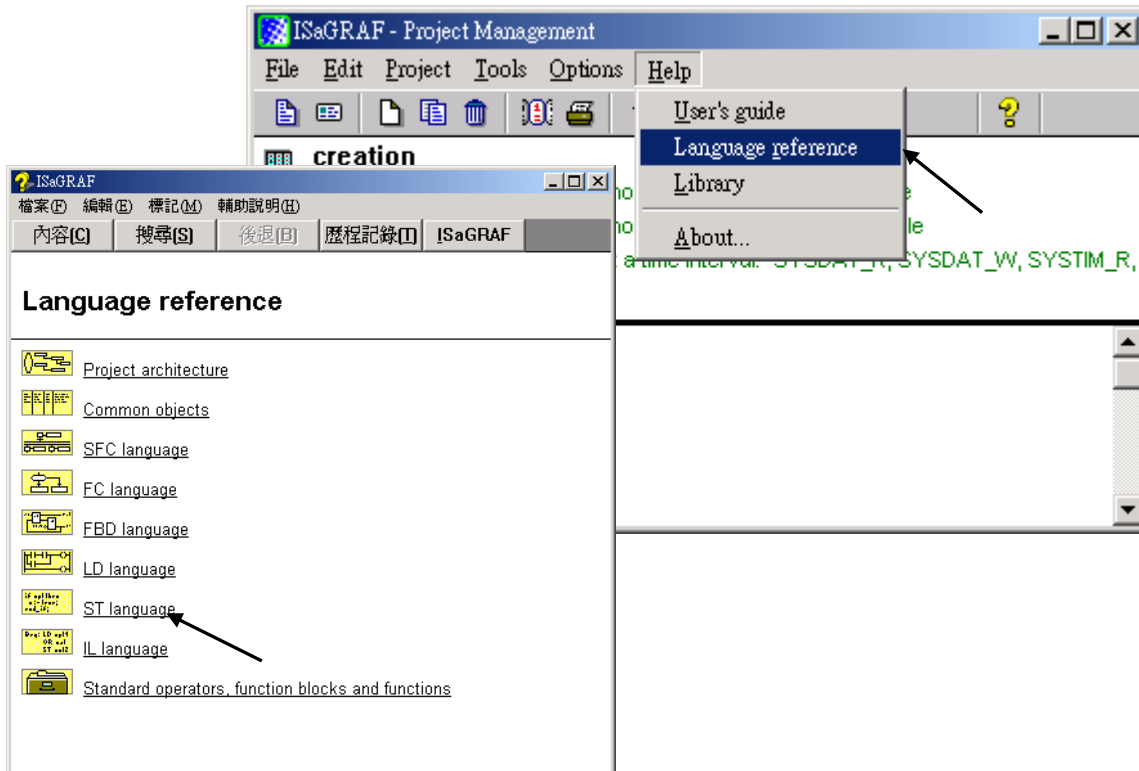

9.2 Installing The ISaGRAF Programming Examples

The ISaGRAF programming examples are installed on the same CD-ROM that you receive with the VP-2xW7/4xx7.

ISaGRAF WinCE ViewPAC Demo Example files:

CD-ROM: \napdos\isagraf\vp-25w7-23w7\demo\

Web: [ICP DAS Home](#) > Product > [Solutions](#) > [Soft PLC, ISaGRAF & Soft-GRAF HMI](#) > [Download - Demo](#)

FTP: <ftp://ftp.icpdas.com/pub/cd/vp-25w7-23w7/napdos/isagraf/vp-25w7-23w7/demo/>

ISaGRAF User's Manual:

[ICP DAS Home](#) > Product > [Solutions](#) > [Soft PLC, ISaGRAF & Soft-GRAF HMI](#) > [Download - Manual](#)

English: \napdos\isagraf\vp-25w7-23w7\english-manu\
 "User_Manual_I_8xx7.pdf" and
 "User_Manual_I_8xx7_Appendix.pdf"

ISaGRAF FAQ:

www.icpdas.com > [Support](#) > [FAQ](#) > [ISaGRAF Soft-Logic PAC](#)

Example lists:

Project Name	Description	I/O Boards Used
Soft-GRAF demo01 ~ demo07	Soft-GRAF HMI demo01 ~ demo07. (sofgr_01~sofgr_08: FAQ-146)	
example1	A simple Web HMI example	slot 0: I-87055W
wp_vb01	VB.NET 2008 demo 01 for VP-2xW7 : DIO demo Please refer to Chapter 6 .	slot 0: I-87055W
wp_vb02	VB.NET 2008 demo 02 for VP-2xW7. Analog I/O Please refer to Chapter 6 .	slot 1: I-87024W slot 2: I-8017HW
wp_vb03	VB.NET 2008 demo 03 for VP-2xW7. Read / Write long integer, float & Timer (No I/O board) Please refer to Chapter 6 .	
vpdmo_01	ViewPAC demo_01: R/W float value from file (FAQ-60)	
vpdmo_02	ViewPAC demo_02: R/W long integer from file (FAQ-60)	
vpdmo_03	To output at a time interval: SYSDAT_R, SYSDAT_W, SYSTIM_R, SYSTIM_W (ST+QLD)	
vpdmo_04	ViewPAC demo_04: User defined Modbus protocol (No using "Mbus")	
vpdmo_05	To do something at some sec later when an event happens (FAQ-17)	slot 0: I-87055W
vpdmo_06	Using Message Array - MsgAry_r , MsgAry_w	
vpdmo_07	Convert float value to string, using real_str & rea_str2	

Project Name	Description	I/O Boards Used
vpdmo_08	PID control, refer to VP-25W7/23W7 CD: \napdos\isagraf\vp-25w7-23w7\english-manu\ "PID_AL...htm"	
vpdmo_09	Store & backup boolean & long integer value To/From files	
vpdmo_10	Store & backup boolean & long integer value To/From EEPROM	
vpdmo_11	Dir is \Micro_SD ,save 3 values to 3 files per 10 minutes ,change file name per month	
vpdmo_14	Retain variable by Retain_b, Retain_N, Retain_f, Retain_t (FAQ-74)	
vpdmo_16	Dir is \Micro_SD ,save 3 values to 1 file every minute ,change file name every day	
vpdmo19	Send UDP String to PC when alarm happens (using variable array),Time_Gap is 1 sec (Chapter 19.2 of the "ISaGRAF User's Manual")	slot0: I-87055W
vpdmo19a	Send UDP String to PC 3 sec later, Time_Gap is 250ms (Chapter 19.2 of the "ISaGRAF User's Manual")	slot0: I-87055W
vpdmo19b	Send UDP Str to PC 3 sec later (vpdmo19a is better), Time_Gap is 250 ms (Chapter 19.2 of the "ISaGRAF User's Manual")	slot0: I-87055W
vpdmo_20	receive String coming from remote PC or controller via UDP/IP	
vpdmo_21	using "com_MRTU" to disable/enable Modbus RTU slave port,	
vpdmo_22	PWM I/O demo. (Pulse Width Modulation), minimum scale is 2ms for ViewPAC	slot 0: I-8055W
vpdmo_23	Send Time String to COM3:RS-232 every second by using COMOPEN, COMSTR_W (FAQ-59)	
vpdmo_24	Send string to COM3 when alarm 1 to 8 happens	slot 0: I-87055W
vpdmo_26	To move some pulse at x-axis of I-8091W of slot 1 in VP-25W7 (Chapter 18 of "ISaGRAF User's Manual")	slot 1: I-8091W
vpdmo_27	Motion x (Chapter 18 of the "ISaGRAF User's Manual")	slot 1: I-8091W slot 2: I-8090W
vpdmo_28	Motion x-y (Chapter 18 of the "ISaGRAF User's Manual")	slot 1: I-8091W slot 2: I-8090W
vpdmo_29	Moving to the Abs. position when CMD is given (Chapter 18 of the "ISaGRAF User's Manual")	slot 1: I-8091W slot 2: I-8090W
vpdmo_30	VP-25W7 (10.0.0.102) link two i8KE8 + I/O , one is 10.0.0.108, one is 10.0.0.109 (FAQ-42)	
vpdmo_31	VP-25W7 (10.0.0.2) link one i8Ke8 + I/O (10.0.0.109) (FAQ-42)	
vpdmo_32	Set up VP-25W7 as TCP/IP Client & link to other TCP/IP server (1	slot 0: I-87055W

Project Name	Description	I/O Boards Used
	connection) (Chapter 19.3 of the "ISaGRAF User's Manual")	
vpdmo_33	Same as vpdmo_32 but send message only when event last for larger than 3 seconds	slot 0: I-87055W
vpdmo_36	Read Real Val from Modbus RTU device (FAQ- 47 & 75)	
vpdmo_37	Write Real Val to Modbus RTU device (FAQ-47 & 75)	
vpdmo_38	Using Modbus function code 6 to write 16 bits (FAQ- 46 & 75)	
vpdmo_39	VP-25W7 + I-8172W connecting FRNET I/O modules (FAQ-82)	
vpdmo_41	VP-25W7's COM2 connecting 1:M7053D + 2:M7045D (MBRTU format, baud=9600) (Chapter 21 of the "ISaGRAF User's Manual")	
vpdmo_42	VP-25W7's COM2 connecting 1:M-7053D to get D/I counter value (MBRTU format, baud=9600)	
vpdmo_43	VP-25W7's COM2 connecting 1:M7017R + 2:M7024 (MBRTU format, baud=9600)	
vpdmo_44	VP-25W7's COM2 connecting 1:M7017RC , Current input, +/- 20mA, 4-20mA (Modbus format)	
vpdmo_45	VP-25W7's COM2 connecting 1:M-7019R (set as T/C K-type input) (MBRTU format, baud=9600)	
vpdmo_46	VP-25W7's COM2 connecting 1:M7080 (MBRTU format, baud=9600)	
vpdmo_48	VB.NET 2005 demo - "MBTCP_demo" (FAQ-51)	
vpdmo_50	Non-linear conversion. like give P to find V (P , V relation listed in a file)	
vpdmo_51	Read 10 REAL value from a file,10 rows,each row has 1 REAL value, use str_real	
vpdmo_52	Msg_F. i8xx7 since 3.19. i7188EG/XG since 2.17/2.15. W8xx7 since 3.36, WP-8xx7 and VP-2xW7	
vpdmo_53	Msg_N. i8xx7 since 3.19. i7188EG/XG since 2.17/2.15. W8xx7 since 3.36, WP-8xx7 and VP-2xW7	
vpdmo_54	Read 20 REAL values from a file,4 rows, each row has 5 REAL values, uses msg_f (FAQ-60)	
vpdmo_55	Read 20 Integers from a file,2 rows, each row has 10 Integers, uses msg_n	
vpdmo56	Retain 17 REAL value in a file, 2 rows, Each row has 10 REAL value	
vpdmo56a	Retain 2 Boo + 17 REAL in a file, 2 rows, Each row has 10 REAL value	

Project Name	Description	I/O Boards Used
vpdmo56b	Retain 25 Integer in a file, 2 rows, Each row has 10 integer value	
vpdmo56c	Retain 2 Boo + 25 Integer in a file, 2 rows, Each row has 10 integer value (FAQ-60)	
vpdmo56d	Retain 17 Real + 2 Boo + 10 Integer in 2 file, Each row has 10 value	
vpdmo56e	Retain more than 255 Real, 255 Boo,255 Integer in 2 file, up to 1024.	
vpdmo_61	i8xx7, WP8xx7, VP-2xW7 : AutoReport data to PC via UDP.Controller=10.0.0.103,PC=10.0.0.91	
vpdmo_62	Send email via Ethernet port. (To one receiver without attached file) (FAQ-67 , 71, 72, 76 or 77)	
vpdmo_63	For WP-8xx7 , VP-2xW7 only. Send email to one receiver with one attached file FAQ- 67 , 71, 72, 76 or 77)	
vpdmo64a	station 1001 , Time synchronization of many controllers via Ethernet.	
vpdmo64b	station 1002 , Time synchronization of many controllers via Ethernet.	
vpdmo65a	VP-2xW7: Record temperature per minute to a file. Then send it by email per day. (FAQ-67 , 71, 72, 76 or 77)	slot 2: I-87018z
vpdmo65b	VP-2xW7: Same as wdm0_65a but add time synchronization and state report to PC. (FAQ-67 , 71, 72, 76 or 77)	slot 2: I-87018z
vpdmo_66	Record 1 to 4-Ch. i8017HW voltage per 20ms, then send this record file by Email	slot 1: I-8024W slot 2: I-8017HW
vpdmo71a	VP-25W7 COM2 connects I-7530 -- "CANopen" ID=1 device (8DI, 8DO, 4AO, 8AI) . (FAQ-86)	
vpdmo71b	Similar as wdm0_71A but connecting two I-7530. One is at COM5, one is at COM6	
vpdmo71c	VP-25W7 COM2 – 7530 -- CAN device to get string (with float or integer data inside)	
vpdmo71d	Similar as wdm0_71c but connecting two I-7530. One is at COM5, one is at COM6	
vpdmo71e	VP-25W7: COM5 --- I-7530 --- CANopen device. COM6 --- I-7530 --- CAN device	
vpdmo72a	New VP-2xW7 redundant system with RU-87P4 + I-87K I/O (FAQ-93)	"RDN_new"
vpdmo72c	New VP-2xW7 redundant system with I-8KE8-MTCP I/O	"RDN_new"
vpdmo74a	get average value of one REAL value. (FAQ-99)	
vpdmo74b	get average value of one Integer value. (FAQ-99)	
vpdmo_76	SMS,VP-25W7 COM3--GTM-201-RS232, use your own phone No. "to_who" in dictionary	
vpdmo77a	sending / Receiving UDP bytes by using eth_udp and eth_send()	

Project Name	Description	I/O Boards Used
	and eth_recv()	
vpdmo77b	sending / Receiving TCP bytes by using eth_tcp and eth_send() and eth_recv()	
vphmi_01	WiewPAC Web HMI example 1 , Display controller's date & time (No I/O board)	
vphmi_02	WiewPAC Web HMI example 2 , DI & DO demo (slot 0: I-87055W)	slot 0: I-87055W
vphmi_03	WiewPAC Web HMI example 3 , R/W Long, float & Timer value (No I/O board)	
vphmi_04	WiewPAC Web HMI example 4 , R/W controller's String (No I/O board)	
vphmi_05	WiewPAC Web HMI example 5, Multi-Page demo, slot 0: I-87055W, Menu is on the Left	slot 0: I-87055W
vphmi05a	WiewPAC Web HMI example 5A, Multi-Page demo, slot 0: I-87055W, Menu is on the Top	slot 0: I-87055W
vphmi_06	WiewPAC Web HMI exampl 6, AIO dmo, slot 1:I-87024W, 2:I-8017HW, scaling is in ISaGRAF	slot 1: I-87024W slot 2: I-8017HW
vphmi_07	WiewPAC Web HMI example 7, AIO demo, slot 1: I-87024W, 2:I-8017HW, scaling is in PC	slot 1: I-87024W slot 2: I-8017HW,
vphmi_08	WiewPAC Web HMI example 8, download controller's file to PC (slot 0: I-87055W)	slot 0: I-87055W
vphmi_09	WiewPAC Web HMI example 9, pop up an alarm window on PC (slot 0: I-87055W)	slot 0: I-87055W
vphmi_11	trend curve demo (slot 1: I-87024W , slot 2: I-8017HW)	slot 1: I-87024W slot 2: I-8017HW
vphmi_12	Record 1 to 8 Ch. I-8017HW 's volt every 50ms and draw trend curve by M.S.Excel	I-8017HW
vphmi_13	Record 1 to 4-Ch. I-8017H's voltage every 10ms and draw trend curve by M.S.Excel	I-8017H

When you install the ISaGRAF programming example for the ViewPAC controller it is recommended that you create an "ISaGRAF Project Group" to install the demo program files into.

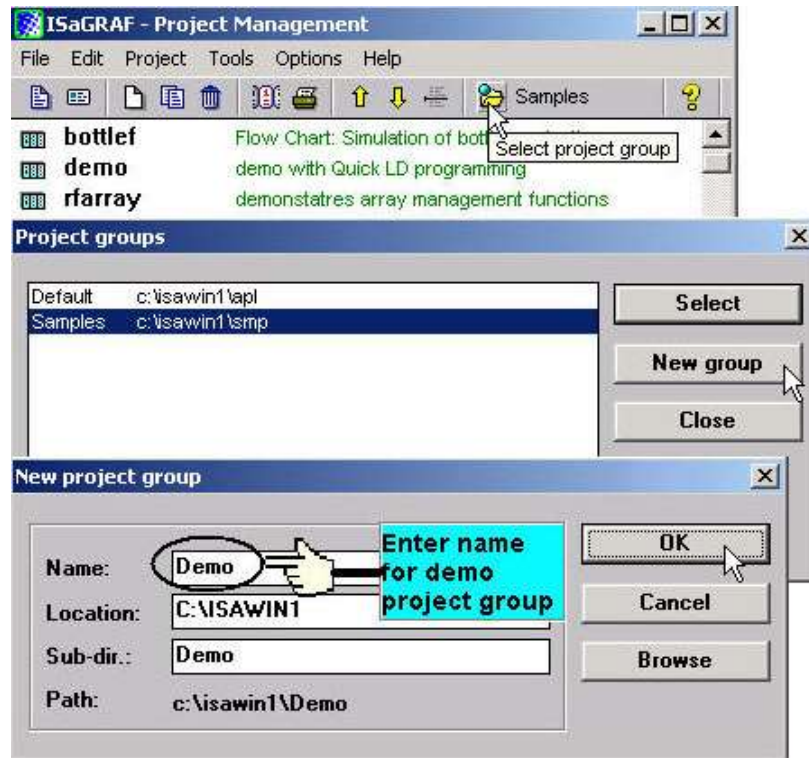

To install the demo programs into the project you have created open the "ISaGRAF Project Management" window to select "Tools" from the menu bar, then select the "Archive" option and then click on "Projects".

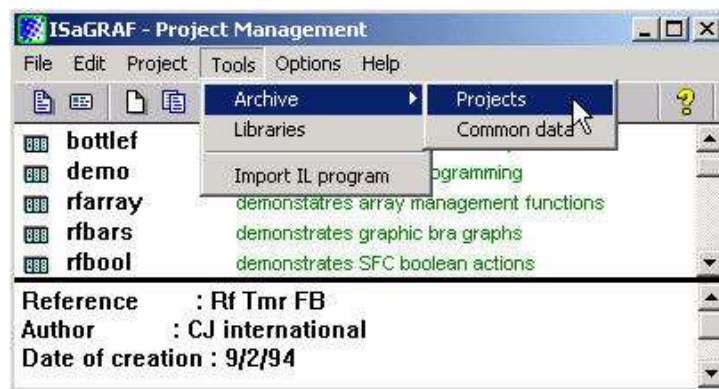

When you click on the "Projects" selection the "Archive Projects" window will open. Click on the "Browse" button to select the drive and the sub-directory where the demo files are located. (`\napdos\isagraf\vp-25w7-23w7\demo\` in the VP-25W7/23W7 CD-ROM) .

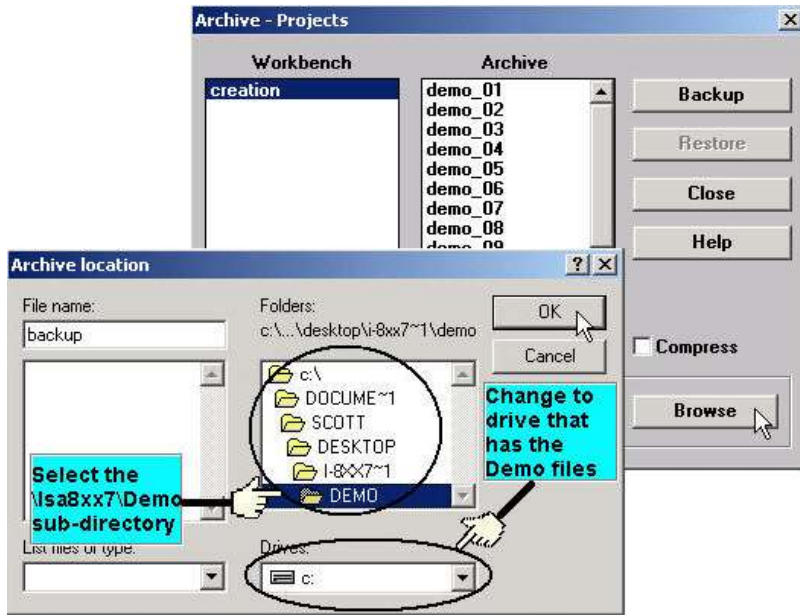

To install all of the Demo files, click on the 1st file on the right, then press and hold down the "Shift" key, continue to hold down the "Shift" key and use your mouse to scroll down to last file in the "Archive" window. Click on the last file name from the demo file location and that will select the entire group of demo files. Lastly, click on the "Restore" button in the "Archive Projects" window and all of the demo files will be installed into the sub-directory you have created.

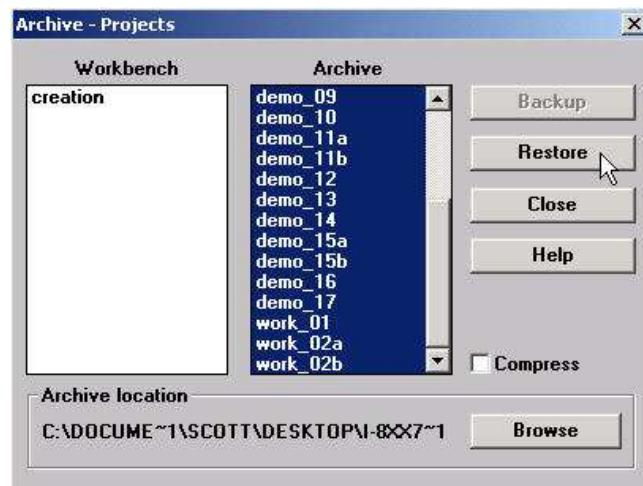

9.3 Frequently Asked Questions

ISaGRAF frequently asked questions (FAQ) website direction:

FAQ (ISaGRAF FAQ: Questions/Descriptions/Demo programs)
www.icpdas.com > [Support](#) > [FAQ](#) > [ISaGRAF Soft-Logic PAC](#)

FAQ Table:

No.	English ISaGRAF Ver.3 FAQ
1	Q: How to get counter value built in I-7000 & I-87xxx remote I/O modules?
2	Q: How to search I/O boards and declare variables automatically for I-8xx7 controllers?
3	Q: How to build a HMI screen by using ISaGRAF?
4	Q: Can I create my own functions inside ISaGRAF?
5	Q: Can I use more than 32 I/O in my ISaGRAF project if I don't have ISaGRAF-256 or ISaGRAF-L?
6	Q: Can I use ISaGRAF controller (I-8417/8817/8437/8837, I-7188EG/XG) as a Modbus Master controller to gather data from other Modbus devices?
7	Q: Can I write my own protocol or third-party protocol to apply on ISaGRAF controllers?
8	Q: What is the limitation of program size of I-8417/8817/8437/8837, I-7188EG & I-7188XG?
9	Q: Can not find I/O boards in the ISaGRAF I/O connection window?
10	Q: I Want to email my ISaGRAF program to someone. How can I archive one ISaGRAF project to a single file?
11	Q: How can I implement motion control in I-8417/8817/8437/8837?
12	Q: My HMI software wants to access to float values and long word values inside the I-8417/8817/8437/8837, 7188EG & 7188XG. How?
13	Q: PWM: Can I generate D/O square pulse up to 500Hz with I-8417/8817/8437/8837, 7188EG & 7188XG controllers? How?
14	Q: Can I use 8K Parallel D/I board to get counter Input up to 500Hz? How ?
15	Q: How to output something at a time interval? For ex. Turn ON at 09:00~18:00 on Monday to Saturday , while 13:00~20:00 on Sunday.
16	Q: How to determine a D/I if it has bouncing problem?
17	Q: How to trigger something at some seconds later when one event happens?
18	Q: Does the ISaGRAF-256 software have I/O Tag limitation? Why not using "ISaGRAF-L" Large version?
19	Q: Why my I-8417/8817/8437/8837 or I-7188EG/XG stop running?
20	Q: How to search a variable name in an ISaGRAF project?
21	Q: When closing my ISaGRAF window, it holds for long time. Why?
22	Q: How to use Proface HMI (Touch panel) to link to I-7188EG/XG, I-8xx7 and WinCon-8x37?
23	Q: How to reduce ISaGRAF code size? How to directly Read / Write ISaGRAF variables by using Network address?
24	Q: How to scale Analog Input and Output of 4 to 20 mA to my engineering format? How to scale Analog Input and Output of 0 to 10 V to my engineering format?

No.	English ISaGRAF Ver.3 FAQ
25	Q: How to detect controller Fault?
26	Q: New ISaGRAF retained variable is better than old one.
27	Q: How to link to Modbus ASCII Slave device?
28	Q: How to use multi-port Modbus Master in the WinCon-8037/8337/8737 & WinCon-8036/8336/8736?
29	Q: How to send/receive message from ISaGRAF PAC to remote PCs or Controllers via Ethernet UDP communication?
30	Q: Setting special "range" parameter of temperature input board to get clear "Degree Celsius" or "Degree Fahrenheit" input value. For ex, "1535" means 15.35 degree.
31	Q: Setting a special "ADR_" parameter of remote I-7000 & I-87K temperature input module to get clear "Degree Celsius" or "Degree Fahrenheit" input value. For ex, "8754" means 87.54 degree.
32	Q: How to access to ISaGRAF variables as array? (A demo program of sending string to COM2 or COM3 when alarm 1 to 8 happens)
33	Q: Setting up more Modbus RTU Slave ports in WinCon ISaGRAF PACs.
34	Q: Compiling error result in different ISaGRAF version?
35	Q: Slow down ISaGRAF driver speed to work better with InduSoft software in W-8036/8336/8736 & W-8046/8346/8746?
36	Q: Redundancy Solution in WinCon-8xx7.
37	Q: I-7188EG/XG support remotely downloads via Modem Link.
38	Q: Setting I-7188EG/XG's COM3 as Modbus RTU Slave port.
39	Q: ISaGRAF version 3.4 & 3.5 now supporting "Variable Array" !!!
40	Q: Setting I-8437/I-8837/I-8437-80/I-8837-80's COM3 as Modbus RTU Slave port.
41	Q: How to connect PC / HMI to a Redundancy system with a single IP address?
42	Q: How to use WinCon connecting to Ethernet I/O? The I/O scan rate is about 30 to 40 msec for 3000 to 6000 I/O channels.
43	Q: How to setup WinCon-8xx7 as TCP/IP Client to communicate to PC or other TCP/IP Server device? Or WinCon automatically report data to PC via TCP/IP?
44	Q: WinCon-8xx7/8xx6 automatically report data to PC/InduSoft or PC/HMI?
45	Q: ISaGRAF controllers display message to EKAN Modview LED.
46	Q: How to Write 16-bits to Modbus RTU devices by Modbus function call No. 6?
47	Q: How to Read or Write Floating Point value to Modbus RTU Slave device?
48	Q: How to use WinCon-8xx7 / 8xx6 to control FRnet I/O?
49	Q: Setting a special "CODE_" parameter of "MBUS_R" & "MBUS_R1" to get a clear "Degree Celsius" or "Degree Fahrenheit" input value of M-7000 temperature module. For ex, "3012" means 30.12 degree.
50	Q: How to connect an ISaGRAF controller to M-7000 Remote I/O?
51	Q: VB.net 2005 Demo program using Modbus TCP/IP protocol to control ISaGRAF PACs
52	Q: VB 6.0 Demo program using Modbus TCP/IP protocol to control ISaGRAF PACs.
53	Q: Performance Comparison Table of ISaGRAF PACs.

No.	English ISaGRAF Ver.3 FAQ
54	Q: iPAC-8xx7 and μ PAC-7186EG support Data Logger function.
55	Q: How to connect I-7018z to get 6 channels of 4 to 20 mA Input and 4 channels of Thermo-couple temperature Input? And also display the value on PC by VB 6.0 program?
56	Q: How to do periodic operation in ISaGRAF PACs?
57	Q: How to record I-8017H's Ch.1 to Ch.4 voltage Input in a user allocated RAM memory in the WinCon-8xx7? The sampling time is one record every 0.01 second. The record period is 1 to 10 minutes. Then PC can download this record and display it as a trend curve diagram by M.S. Excel.
58	Q: How to record I-8017H's Ch.1 to Ch.4 voltage input in S256 / 512 in I-8437-80 or I-8837-80? The sampling time is one record every 0.05 second. The record period is 1 to 10 minutes. Then PC can download this record and display it as a trend curve diagram by M.S. Excel.
59	Q: Some skill to operate RS-232/422/485 serial COM Port by COM functions
60	Q: How to read / write file data in WinCon?
61	Q: How to connect RS-485 Remote I-7000 and I-87K I/O modules in I-8xx7, I-7188EG/XG and WinCon-8xx7 PAC? How to program RS-485 remote I-7017RC, I-87017RC and I-7018Z?
62	Q: How to setup a redundant system with Ethernet I/O?
63	Q: Why my RS-485 remote I-7000 and I-87K Output module's host watchdog function doesn't work to reset its output channels to safe output value while the RS-485 communication cable is broken?
65	Q: ICP DAS release Stable and Cost-effective Data Acquisition Auto-Report System. (VC++ 6.0, VB 6.0 and ISaGRAF demo program are available)
66	Q: How to process the Integer or Real value coming from the RS-232 / RS-485 device? Like the device of Bar-Code reader or RS-232 weight meter.
67	Q: How to send email with one attached file by WinCon-8xx7 or iPAC-8447 / 8847 or μ PAC-7186EG?
68	Q: Why the W-8xx7 or I-8xx7 or I-7188EG/XG always reset? How to fix it?
69	Q: Why my PC can not run "ftp" to connect W-8347 or W-8747?
70	Q: How to do Time Synchronization and record state of many ISaGRAF PACs?
71	Q: Application: Record 10-Ch. temperature value into a file in W-8xx7 every minute. When 24 hour recording is finished, send this record file by email every day.
72	Q: Application sample: Record Voltage / Current input by W-8xx7 every 20 ms for 1 to 10 minutes. Then send this record file by email.
73	Q: Why does the I-7017 or I-87017's Current Input reading value become double or incorrect?
74	Q: How to use ISaGRAF new Retain Variable? What is its advantage?
75	Q: Why my ISaGRAF project can not connect Modbus Slave device correctly?
77	Q: Application sample: Record Voltage / Current input by μ PAC-7186EG every second for 1 to 10 minutes. Then send this record file by email.
80	Q: Application: Record 10-Ch. temperature value into a file in μ PAC-7186EG every minute. When 24 hour recording is finished, send this record file by email every day.
81	Q: How to measure +/-150VDC in ISaGRAF controllers plus the I-87017W-A5 I/O card?

No.	English ISaGRAF Ver.3 FAQ
82	Q: An easy way to program the fast FRnet remote I/O modules.
83	Q: How to set I-8x37, I-8x37-80, I-7188EG and μ PAC-7186EG's TCP recycling time?
84	Q: Application: A Cost Effective and Hot-Swap Redundancy System by μ PAC-7186EG or I-8437-80 plus RU-87P4/8.
86	Q: The WinCon-8347 / 8747 , μ PAC-7186EG and iP-8447 / 8847 connecting one or several I-7530 to link many CAN or CANopen devices and sensors.
87	Q: What does it mean and how to fix it when the 7-segment LED shows error messages of Err00, Err02, Err03, Err90 or E.0001 after booting the PAC?
88	Q: Function Modifications: The W-8347/8747, μ PAC-7186EG, I-8x37-80, I-8xx7 and I-7188EG/XG with S256/512 and X607/608 no longer support old retain method, please change to use the better new retain method to retain variables.
089	Q: Why my μ PAC-7186EG unable to renew the driver and ISaGRAF application?
090	Q: How to use I-7017Z module in ISaGRAF PAC?
091	Q: How to use ISaGRAF PAC plus I-87089-the VW sensor Master card to measure the Vibration Wire frequency to calculate the stress of constructions?
092	Q: Setting μ PAC-7186EG's and I-7188EG/XG's COM3 or COM2 as Modbus RTU Slave port.
093	Q: New Hot-Swap and Redundant solution for the WinCon-8347 / 8747.
094	Q: How to update the WinCon-8347/8747's OS?
095	Q: The WinCon-8xx7 supports Max. 32 Modbus TCP/IP connections since Its Driver version 4.03.
096	Q: Release two C-Function-Blocks to read max. 24 Words or 384 Bits from Modbus RTU / ASCII devices.
097	Q: How to modify the IP, NET-ID and Modbus RTU Slave port setting of the W-8347 / 8747 by an USB pen drive (without Mouse and VGA)?
098	Q: Application: Link Serial COM Port to the Modbus RTU device by COM functions .
099	Q: How to get an average value of a Real or Integer variable which is samplped every fixed interval (or sampled in every PLC scan) ?
100	Q: How to use I-8084W (4 / 8 – Ch. Counter or 8-Ch. frequency) ?
101	Q: How to read max. 120 Words or max. 60 Long-Integers or max. 60 Real value from Modbus RTU / ASCII devices by using MBUS_XR or MBUS_XR1 function block (for WP-8xx7 / 8xx6 and VP-25W7/23W7/25W6/23W6 and Wincon-8xx7 / 8xx6 only) ?
102	Q: Why PC can not connect the WP-8xx7 or VP-25W7/23W7 's FTP server ?
103	Q: Using RS-232 Or USB Touch Monitor With WinPAC.
104	Q: Why my PC running ISaGRAF can not connect the ISaGRAF PAC correctly ?
105	Q: Program The 8-Channel PWM Output Board : I-8088W In WP-8xx7, VP-25W7/23W7 And iP-8xx7 PAC.
106	Q: How to display the frequency trend curve by running ISaGRAF and C# .net 2008 program in the WinPAC-8xx7 plus I-8084W?
107	Q: How to do auto-time-synchronization and measure the local Longitude and Latitude by using the i-87211W GPS I/O module in ISaGRAF PAC ?
108	Q: How to display the temperature trend curve by running ISaGRAF and C# .net 2008 program in the WinPAC-8xx7 plus i-87018z?

No.	English ISaGRAF Ver.3 FAQ
109	Q: How to adjust the system time of some ISaGRAF PACs via Ebus by using ISaGRAF PAC and I-87211w?
110	Q: ZigBee Wireless Application: How to control remote I/O and acquire data?
111	Q: How to use the GTM-201-RS232 to send a short message in user's local language ?
112	Q: Program the I-8093W (3-axis high speed Encoder input module) by ISaGRAF.
113	Q: Linking ISaGRAF PAC to Modbus TCP/IP Slave Devices By Modbus TCP/IP Protocol.
114	Q: How to avoid garbled content when printing ISaGRAF PDF documents?
115	Q: Working eLogger HMI with ISaGRAF SoftLogic in the WP-8xx7, VP-2xW7 and XP-8xx7-CE6 PAC. (the document version is 1.03 released on Jul.15,2010)
116	Q: How to enable the second to fifth Modbus RTU slave port of the WP-8xx7 and VP-2xW7 without modifying the ISaGRAF project ?
117	Q: How to install the ISaGRAF Ver. 3 on Windows Vista or Windows 7?
118	Q: A M.S. VC++ 6.0 Demo Program To Connect One WP-8xx7 by Modbus TCP Protocol.
119	Q: How to implement the communication redundancy between the central control station and the local stations?
120	Q: How to calculate the moving average value of a variable by c-functions "Aver_N" or "Aver_F" ?
121	Q: How to install or remove the ISaGRAF development platform properly?
122	Q: How To Solve The USB-Freeze Problem Of The W-8x4x ? How To Update The W-8x4x 's OS Image ?
123	Q: How to move the InduSoft picture faster in the W-8xx6 / WP-8xx6 / VP-25W6 / XP-8xx6-CE6 ?
124	Q: A Web HMI Example for ISaGRAF Professional XPAC XP-8xx7-CE6-PRO – by FrontPage .
125	Q: XP-8xx7-CE6 And iDCS-8000 (Or ET-7000 Or Modbus TCP Slave device) Redundant System.
126	Q: How to use the WP-8847 to connect ET-7018Z and ET-7044D and develop the HMI program by InduSoft, VS2008 C# and VB.NET ?
128	Q: How to use The ISaGRAF PAC plus i-87113DW - the master card of the Carlson Strain Gauage Inputs ?
129	Q: How To Connect The ICP DAS Power Meter – PM-2133 and PM-2134 By The ISaGRAF PAC ?
130	Q: How to automatically synchronize the time of WP-8x47/VP-23W7 over a network ?
131	Q: Soft-GRAF : Create A Colorful HMI in The XP-8xx7-CE6 and WP-8xx7 and VP-2xW7 PAC (paper version: 1.3) .
132	Q: Motion Control - Using I-8094F/8092F/8094
133	Q: How to send and receive UDP / TCP data ?
134	Q: How to reset the ISaGRAF driver or reset the whole controller by software ?
135	Q: How to program ISaGRAF PAC to support SQL Client to write data to (or read data from) Microsoft SQL server ?
136	Q: HART Solution : ISaGRAF PAC plus I-87H17W
137	Q: How to connect to remote server and send network package via GPRS with uPAC-5000

No.	English ISaGRAF Ver.3 FAQ
	series controller?
138	Q: How to program an XP-8xx7-CE6 redundant system (with I-87K8 expansion base or Modbus I/O or other I/O) ?
139	Q: How to install/use ISaGRAF 3.55 Demo Version and its limitations
140	Q: How to communicate between InduSoft local HMI and ISaGRAF PACs via Modbus TCP protocol?
141	Q: iP-8xx7/μPAC-7186EG/I-8xx7/I-8xx7-80 provide the Flash memory write protect feature
142	Q: How to protect your ISaGRAF program from used by the unauthorized people?
143	Q: How to Make “ISaGRAF WinCE PAC” to Connect to the Internet and Send Data by GPRS Dial-up?
144	Q: A new function block “Mbus12w” to write max. 12 words to Modbus slave devices.
146	Q: Soft-GRAF Studio : Create a Colorful HMI in the XP-8xx7-CE6 & WP-8xx7 & VP-2xW7 PAC
147	Q: How to use the VPD-130 to read the μPAC-7186EG’s system date and time via RS-485?
149	Q: How to make the ISaGRAF WinCE PAC play a sound ?
150	Q: ISaGRAF Tutorial Video .
151	Q: How to use FTP Client to upload log files to remote FTP Server on PC?
152	Q: How to control the IR module, IR-210/IR-712, with the ISaGRAF PACs?
153	Q: How to use the ISaGRAF PAC to communicate with a far away Modbus TCP server or a ftp server by the 3G or 2G wireless GPRS ?
154	Q: How to use the FRnet AI/AO module with the ISaGRAF PAC ?
155	Q: How to save the value of ISaGRAF variables to the Micro_SD memory in the WP-5xx7, WP-8xx7 and VP-25W7 PAC ?
156	Q: ISaGRAF PAC connects a DL-100TM485 to measure humidity and temperature values.
157	Q: How to link to the Temperature and Humidity module, DL-100T485, with the ISaGRAF PACs?
158	Soft-GRAF Application – Data Logger
159	Q: How to use the tGW-700 Series, Modbus TCP to RTU/ASCII gateway, with the ISaGRAF PAC?
160	Soft-GRAF Application - Alarm Lists
161	Using many Modbus function blocks Mbus_AR and Mbus_AW in a “for” loop in the ISaGRAF PAC
162	Q: How to deliver event data by ISaGRAF PAC ?
163	The reason of blinking power LED or L1 LED on PAC while Ethernet connect fail.
165	Q: How to use the ISaGRAF PAC to control the tM-series and LC-series Modbus I/O Modules?
166	Q: ISaGRAF WinCE PAC - Schedule Control.
167	Q: Develop your own c-function and c-function blocks in the ISaGRAF WinCE PAC.

Chapter 10 C# .NET 2008 Program Access To ISaGRAF Variables

Important Notice:

Please store your application programs and data files in the `\Micro_SD` . Don't store them in the `\System_disk`. That is because the `\System_Disk` is using Nor Flash memory. Its size is small and major purpose is for storing OS, ISaGRAF driver, some basic utilities and DLL . The Nor Flash memory is not good for frequently updating files. If update files frequently in the `\System_Disk` (for example, update a file every 1 to 5 seconds, then it will be about ten thousand more updates in one day), the data or files in the `\System_disk` may crush or lost for some days or months later.

This chapter lists the procedure for creating the first demo program by Visual Studio .NET 2008 development tool. There is some sample programs in the ISaGRAF WinCE ViewPAC CD-ROM

ISaGRAF WinCE ViewPAC CD-ROM : `\napdos\isagraf\vp-25w7-23w7\CSharp.net-2008-demo\`

- wp_CSharp01 : Digital I/O demo with one I-87055W in slot 0 of the ViewPAC.
- wp_CSharp02 : Analog I/O demo with one I-87024W in slot 1 and one I-8017HW in slot 2.
- wp_CSharp03 : Read / Write ISaGRAF internal integers, timers and real variables. (No I/O)

The related ISaGRAF demo project name are "wp_vb01.pia" , "wp_vb02.pia" and "wp_vb03.pia" in the same directory.

10.1 Create a New Project

1. In the first, users need to open Microsoft Visual Studio .NET 2008 software. And then in the menu of "File", please run the "New Project" .

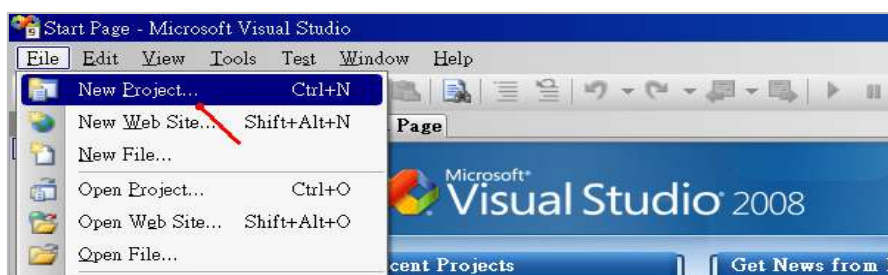

2. Check the "Smart Device" on the left, then selecting the ".NET frame work 2.0" and "Smart Device Project". Then entering a proper project name and the last click on "OK".

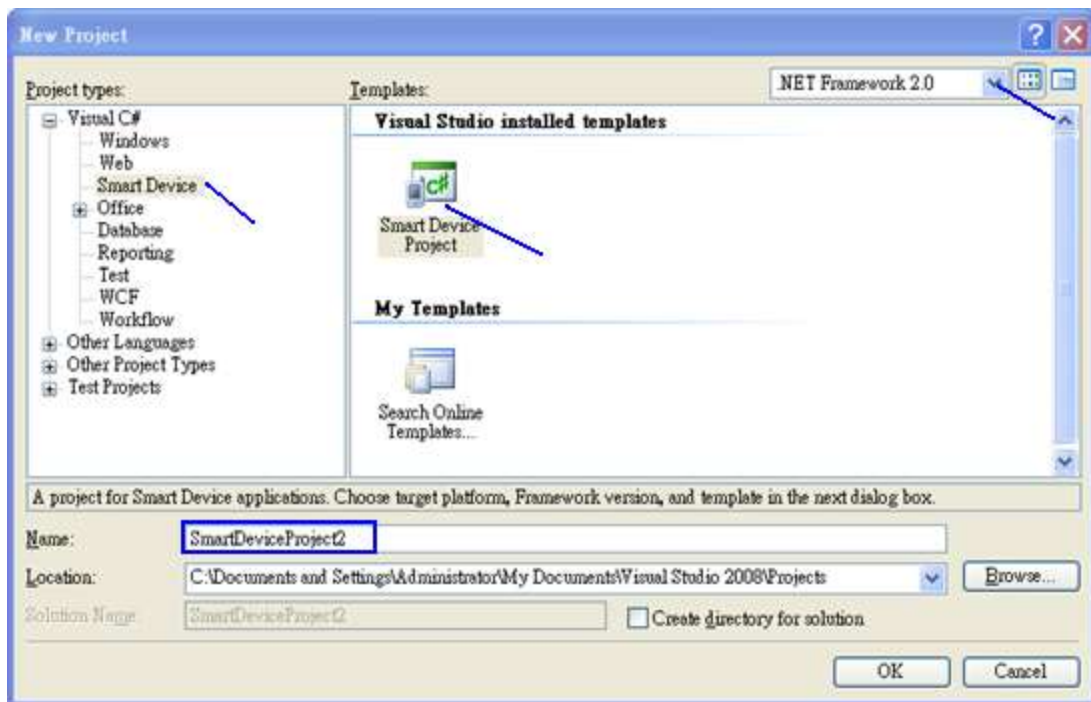

3. Select the "Device Application" and "Windows CE" and ".NET Compact Framework Version 2.0", then click on "OK".

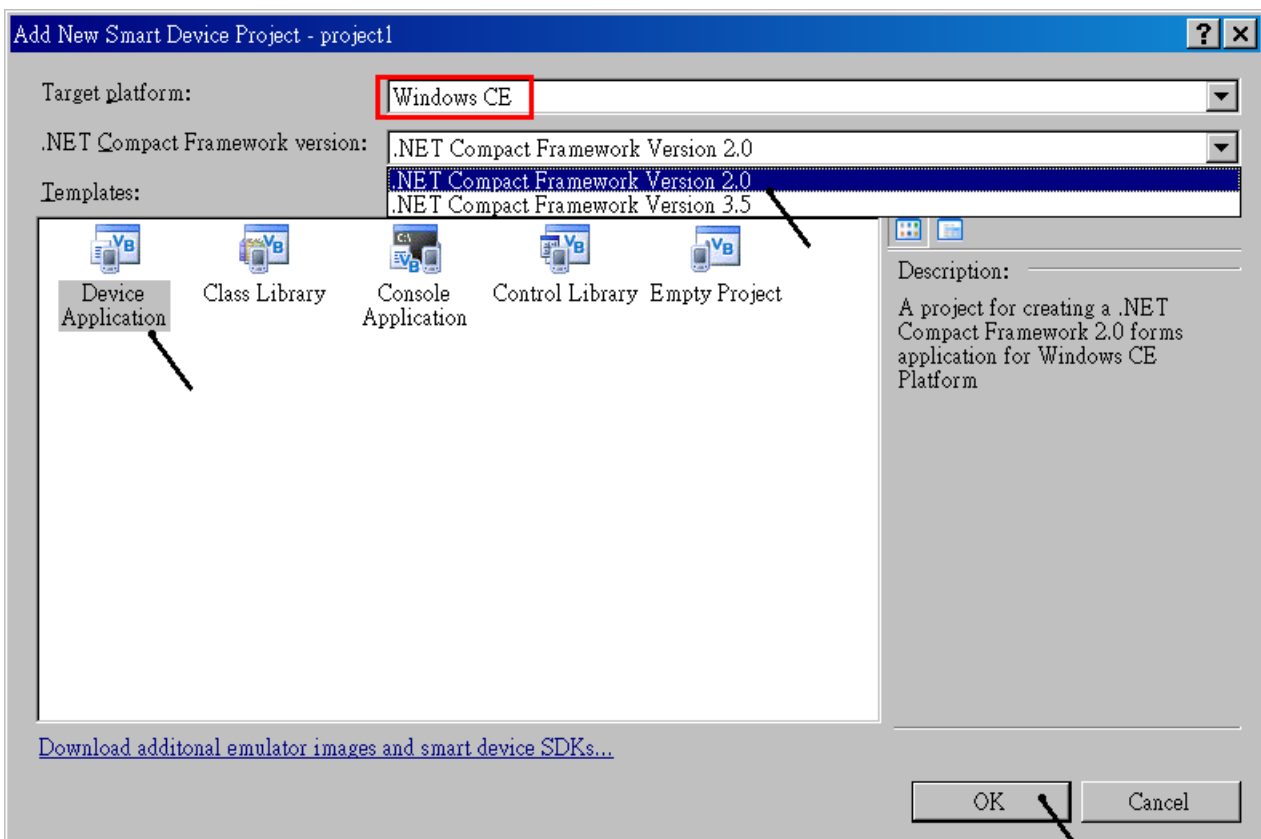

10.2 Add Project Reference for an Application

The “QuickerNet” library contains all modules’ functions. Before you use the “Quicker” keyword in the program, you must add the “QuickerNet.dll” into the reference list of your application.

1. Right click on the Project name on the right hand side, then select “Add Reference...”

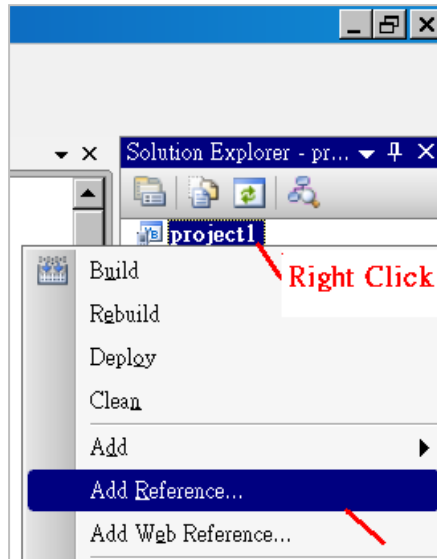

2. Select the “mscorlib” in the list box and click the button “OK” (the component “mscorlib” must appear in the Selected Components area)

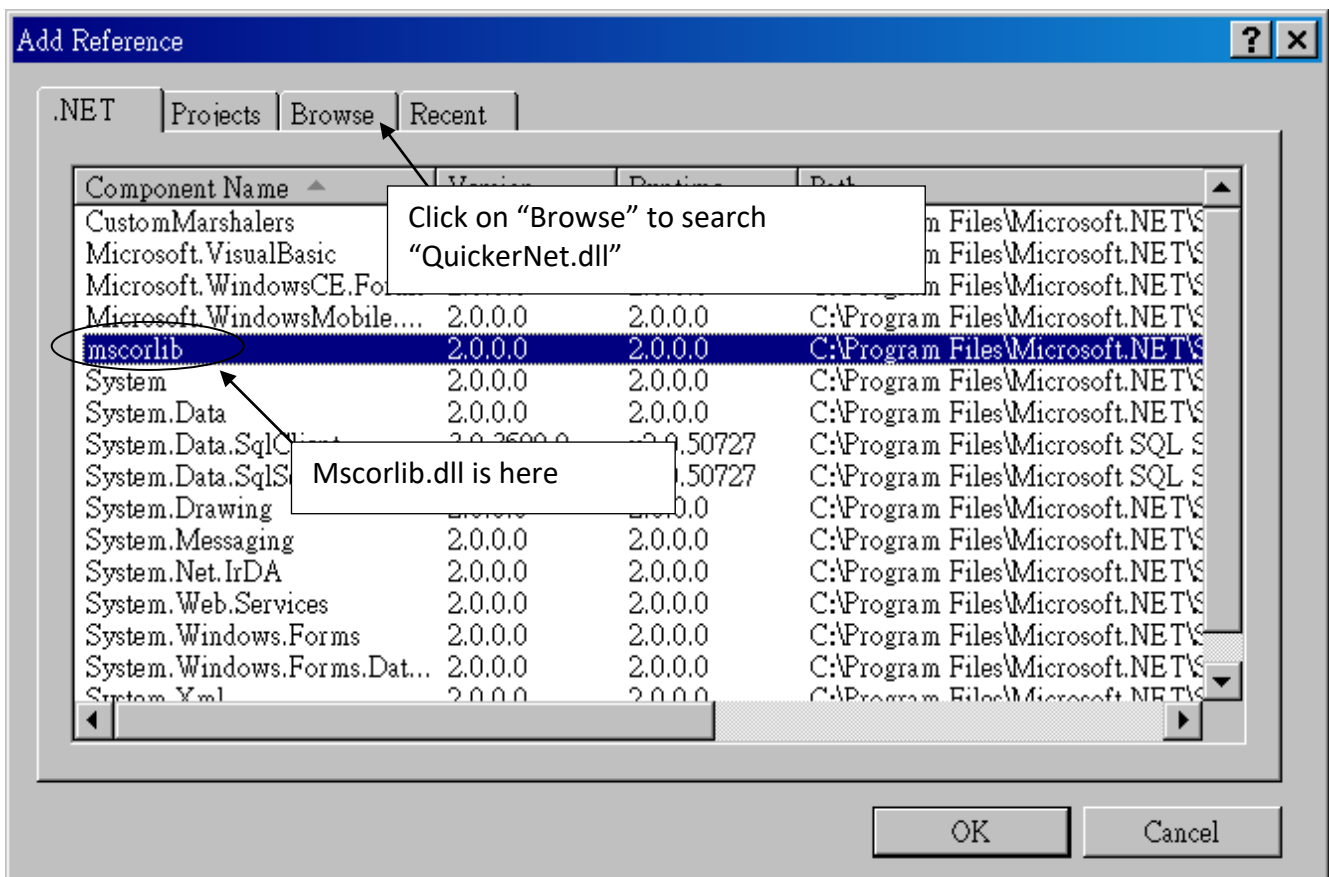

- Click the “Browse” button. Select the “QuickerNet.dll” from VP-2xW7/4xx7 CD-ROM : \napdos\isagraf\vp-25w7-23w7\CSharp.net-2008-demo\wp_CSharp01 subfolder or from your own location.

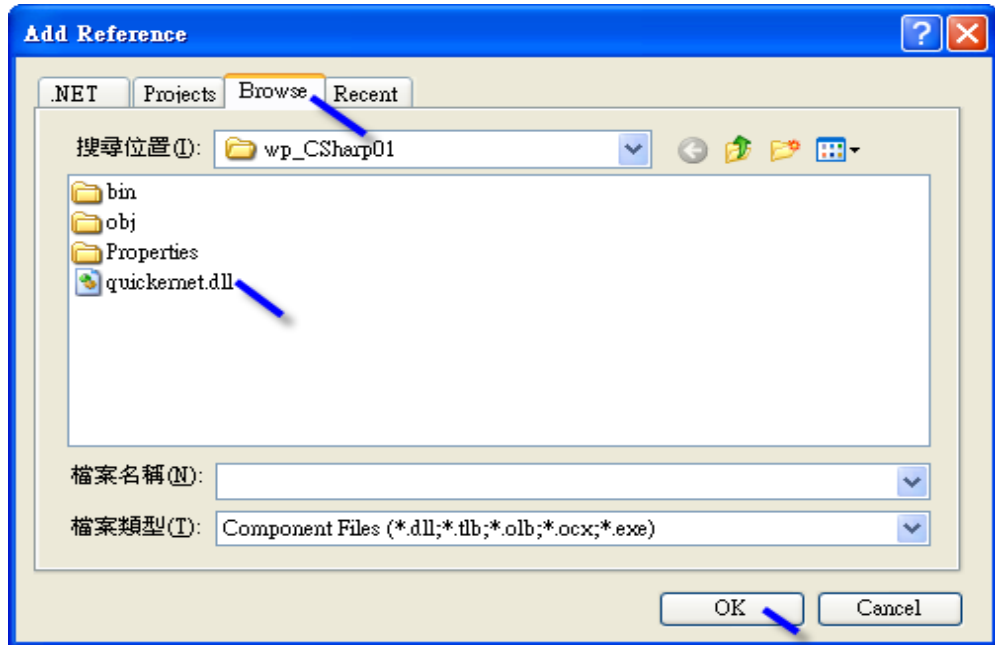

- When both “mscorlib” and “QuickerNet.dll” are added, you can see them in the solution explorer as below

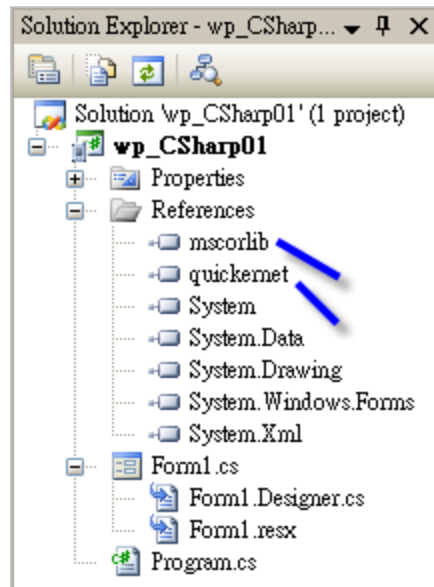

- Right-click on the “Form1.cs” and select “View Code” from the pop-up. Move cursor to top and insert the “using Quicker;” in the first statements.

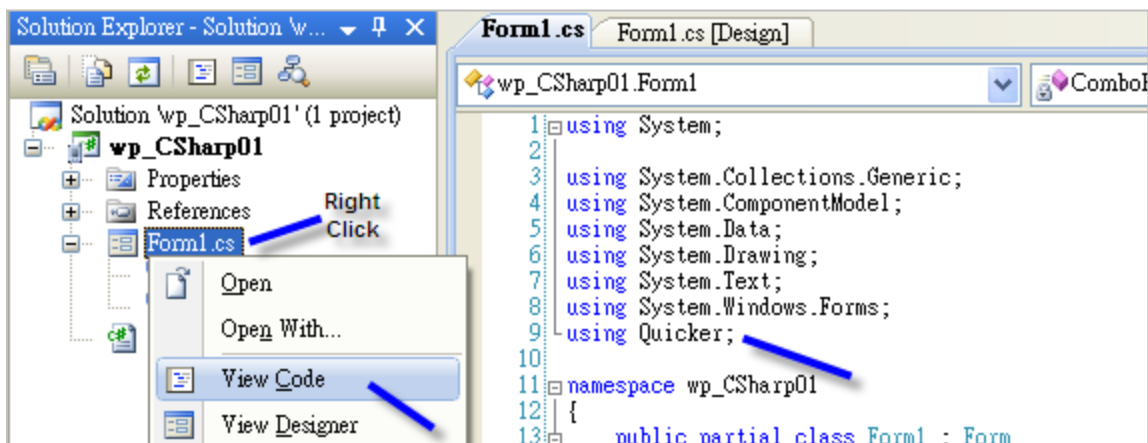

Then you can design all required objects and actions inside your C# Forms.

10.3 Compiling an Application Program

When you have finished writing a program, you can build an application by the following steps.

1. Remember to save at any time for safety.

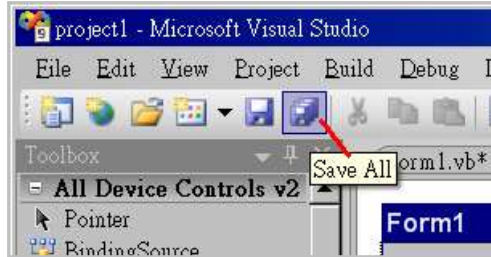

2. Then compile (Build) the project . The result is listed in the "Error List" windows at the bottom.

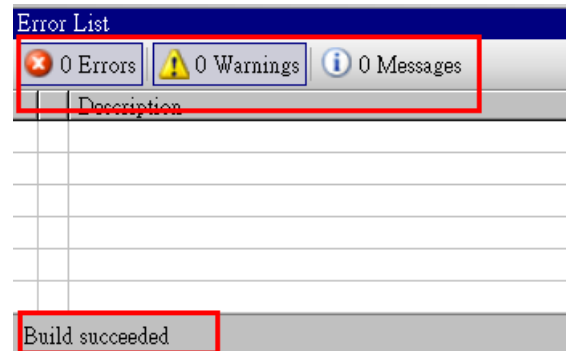
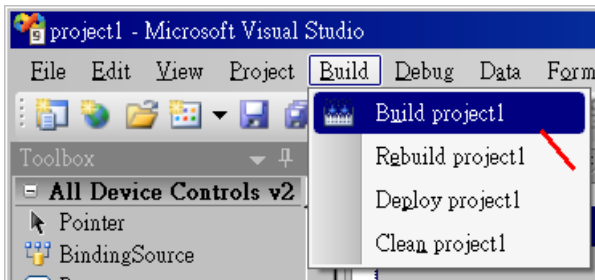

3. You can find the execution file in

<Your C# .net Project folder> \bin\Release\ <project_name>.exe

Please copy this execution file to the ViewPAC 's \System_Disk\ISaGRAF\ path to run it.

Note:

User may copy the C#.NET execution file to other path to run it but there should contain at least three DLL files with it or it cannot run correctly.

For ex, the project1.exe can run in the \Micro_SD\ path if there is three plus one file in it. The "project1.exe" , "QuickerNet.dll" , "Quicker.dll" and "Mscorlib.dll" .

(The "QuickerNet.dll" , "Quicker.dll" and "Mscorlib.dll" can be copied from the ViewPAC 's "\System_disk\ISaGRAF\" path)

10.4 QuickerNET.DLL

This section we will focus on the description of the application example of QuickerNET.DLL functions. There are some functions that can be used to R/W data from/to the ISaGRAF SoftLogic. The functions of QuickerNET.DLL can be clarified as two groups as depicted as below:

1. Digital R/W Functions
2. Analog R/W Functions

10.4.1 Digital R/W Functions

■ UserSetCoil

Description:

This function is to set the value to a Boolean variable by Modbus network address.

Syntax:

```
UserShare.UserSetCoil(ushort iUserAddress, byte iStatus)
```

Parameter:

iUserAddress : Specify the Modbus Network Address of Variable (1 to 8191)

iStatus : Set the status. For instance, iStatus = 1 for True, iStatus = 0 for False

Return Value:

None

Example:

```
// Set the output variable of Modbus Network Address "1" to True.
```

```
UserShare.UserSetCoil(Convert.ToUInt16(1), 1);
```

Demo program :

ISaGRAF WinCE ViewPAC CD-ROM:

```
\\napdos\isagraf\vp-25w7-23w7\CSharp.net-2008-demo\wp_CSharp01
```

■ UserGetCoil

Description:

This function is to get the value from a Boolean variable by Modbus network address.

Syntax:

```
UserShare.UserGetCoil(ushort iUserAddress, out byte iStatus)
```

Parameter:

iUserAddress : Specify the Modbus Network Address of Variable (1 to 8191)

iStatus : Get the variable status , iStatus = 1 for True, iStatus = 0 for False

Return Value:

None

Example:

```
// Get the variable status of Network Address "1".
```

```
byte iStatus;
```

```
UserShare.UserGetCoil(Convert.ToUInt16(1),out iStatus);
```

Demo program :

ISaGRAF WinCE ViewPAC CD-ROM:

```
\\napdos\isagraf\vp-25w7-23w7\CSharp.net-2008-demo\wp_CSharp01
```

10.4.2 Analog R/W Functions

■ **UserSetReg_short** ■ **UserSetReg_long** ■ **UserSetReg_float**

Description:

These functions are to set 16-bit short integer , 32-bit long integer & 32-bit float value to the specified Modbus network address.

Syntax:

```
UserShare.UserSetReg_Short(ushort iUserAddress, out int iStatus)
```

```
UserShare.UserSetReg_Long(ushort iUserAddress, out int iStatus)
```

```
UserShare.UserSetReg_Float(ushort iUserAddress, out float iStatus)
```

Parameter:

iUserAddress : Specify the Network Address of Variable (1 to 8191)

iStatus : Set the short or long integer or float value.

Example:

```
// Set a long value "1234567" to the variable of Modbus Network Address "1".
```

```
int temp1=1234567;
```

```
UserShare.UserSetReg_long(Convert.ToUInt16(1), out temp );
```

```
// Set a short value "-1234" to the variable of Modbus Network Address "3".
```

```
int temp2= -1234;
```

```
UserShare.UserSetReg_short(Convert.ToUInt16(3), out temp2 );
```

```
// Set a float value "2.174" to the variable of Modbus Network Address "4".
```

```
float temp3=2.174;
```

```
UserShare.UserSetReg_float(Convert.ToUInt16(4), out temp3 );
```

Demo program :

ISaGRAF WinCE ViewPAC CD-ROM:

- \napdos\isagraf\vp-25w7-23w7\CSharp.net-2008-demo\wp_CSharp02 for R/W analog I/O
- \napdos\isagraf\vp-25w7-23w7\CSharp.net-2008-demo\wp_CSharp03 for R/W internal Boolean, long integer, Timer and Real (floating-point) values.

Note:

The long integer & timer & real variable's Network Address No. must occupy 2 No. in the ISaGRAF project. (refer to section 4.2 of "User's Manual of ISaGRAF Embedded Controllers" or in the CD-ROM: \napdos\isagraf\vp-25w7-23w7\english-manu\User_Manual_I_8xx7.pdf")

Description:

These functions are to get 16-bit short integer , 32-bit long integer & 32-bit float value from the specified Modbus network address.

Syntax:

```
UserShare.UserGetReg_Short(ushort iUserAddress, out int iStatus)
```

```
UserShare.UserGetReg_Long(ushort iUserAddress, out int iStatus)
```

```
UserShare.UserGetReg_Float(ushort iUserAddress, out float iStatus)
```

Parameter:

iUserAddress : Specify the Network Address of Variable (1 to 8191)

iStatus : Get the short or long integer or float value.

Example:

```
float float_val
```

```
short short_val
```

```
int long_val
```

```
// Get float value of the variable of Modbus Network Address "7".
```

```
UserShare.UserGetReg_float(Convert.ToUInt16(7),out float_val);
```

```
// Get long value of the variable of Modbus Network Address "9".
```

```
UserShare.UserGetReg_long(Convert.ToUInt16(9),out long_val);
```

```
// Get short value of the variable of Modbus Network Address "11".
```

```
UserShare.UserGetReg_short(Convert.ToUInt16(11),out short_val);
```

Demo program :

ISaGRAF WinCE ViewPAC CD-ROM:

- \napdos\isagraf\vp-25w7-23w7\CSharp.net-2008-demo\wp_CSharp02 for R/W analog I/O
- \napdos\isagraf\vp-25w7-23w7\CSharp.net-2008-demo\wp_CSharp03 for R/W internal Boolean ,long integer, Timer and Real (floating-point) values.

Note:

The long integer & timer & float variable's Network Address No. must occupy 2 No. in the ISaGRAF project. (refer to section 4.2 of "User's Manual of ISaGRAF Embedded Controllers" or in the CD-ROM: \napdos\isagraf\vp-25w7-23w7\english-manu\ " User_Manual_I_8xx7.pdf")

Chapter 11 More Useful Features

This chapter will introduce gradually added and some useful features in ISaGRAF WinCE-based PAC. Users can visit the ISaGRAF FAQ to understand these usages.

11.1 FAQ-167: Develop Your Own C-function and C-function Blocks in the ISaGRAF WinCE PAC

The FAQ-167 provides demo programs to guide users to develop their own C-function and C-function Block. More at: www.icpdas.com > [Support](#) > [FAQ](#) > [ISaGRAF Soft-Logic PAC](#) > FAQ-167

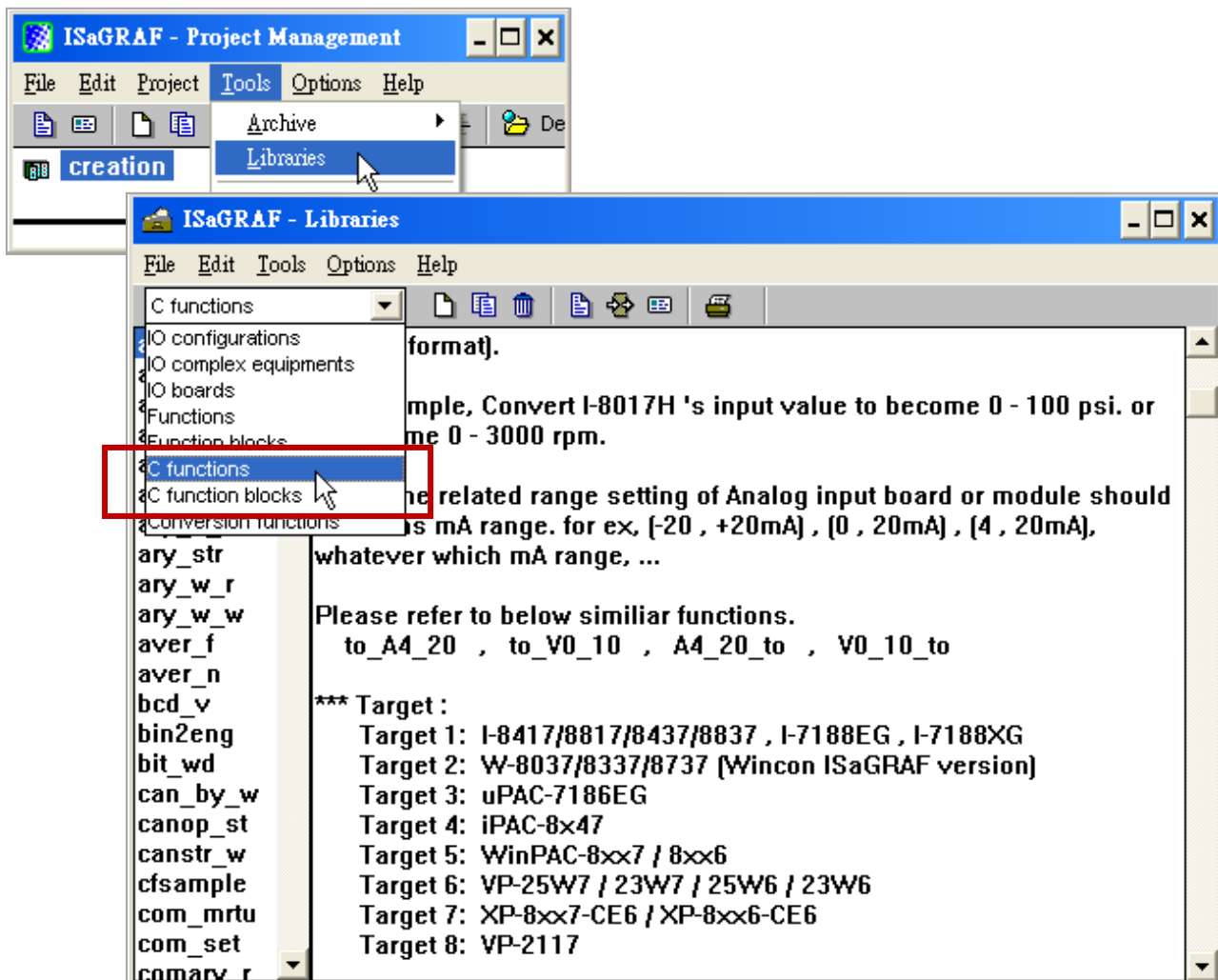

11.2 FAQ-166: ISaGRAF WinCE PAC - Schedule Control

- The ISaGRAF WinCE-based PACs support Schedule Control. Users just need a few simple steps to configure the date events, such as normal days, weekend, special holidays, make-up workdays and four seasons to meet the complex scheduling control needs.
- One ISaGRAF PAC can control many Schedules for maximum 10 control devices (Target). Each control device (Target) can control one Boolean, one Integer and one Real variable (total 3 variables).
- More at: www.icpdas.com > [Support](#) > [FAQ](#) > [ISaGRAF Soft-Logic PAC](#) > FAQ-166

2013 Dec.

Sun	Mon	Tue	Wed	Thu	Fri	Sat
1	2	3	4	5	6	7
8	9	10	11	12	13	14
15	16	17	18	19	20	21
22	23	24	25	26	27	28
29	30	31	1	2	3	4

Normal Days: Mon. ~ Fri.
Holiday 1: Sat./ Sun.
Holiday 2: Wed....
Special Day: 10/1, 10/10, 12/24...

Schedule Control Utility

Max.50

Max.15

11.3 FAQ-160: Soft-GRAF Application - Alarm Lists

Users can use the Soft-GRAF HMI software to build an alarm-list application in the ISaGRAF WinCE-based PAC.

- The Soft-GRAF HMI object - "g_Alarm" can send the max. of 3000 messages a day.
- The FAQ-160 provides demo programs that can send a short message to some operator's mobile phone when some emergency occurs.
- The system can create a new file to save the alarm messages in each day. Users can also export these alarm files to a USB pen drive. (File format: .csv or .txt)
- Users can enable the function of FTP Client to send the alarm file to the control center (FTP Server1, FTP Server2) automatically at a fixed time each day. Or, users can also get the PAC files through the FTP Server.
- More at: www.icpdas.com > [Support](#) > [FAQ](#) > [ISaGRAF Soft-Logic PAC](#) > FAQ-160



11.4 FAQ-158: Soft-GRAF Application - Data Logger

Users can use the Soft-GRAF HMI software to build a data logger application in the ISaGRAF WinCE-based PAC.

- The Soft-GRAF HMI object - " g_Logger1" can record the max. of 50 tags.
(Data format: Boolean, 16-bit signed integer, 32-bit signed integer and 32-bit Float)
- The system can create a new file to save the alarm messages in each day. Users can also export these alarm files to a USB pen drive. (File format: .csv or .txt)
- Users can enable the function of FTP Client to send the alarm file to the control center (FTP Server1, FTP Server2) automatically at a fixed time each day. Or, users can also get the PAC files through the FTP Server.
- More at: www.icpdas.com > [Support](#) > [FAQ](#) > [ISaGRAF Soft-Logic PAC](#) > FAQ-158

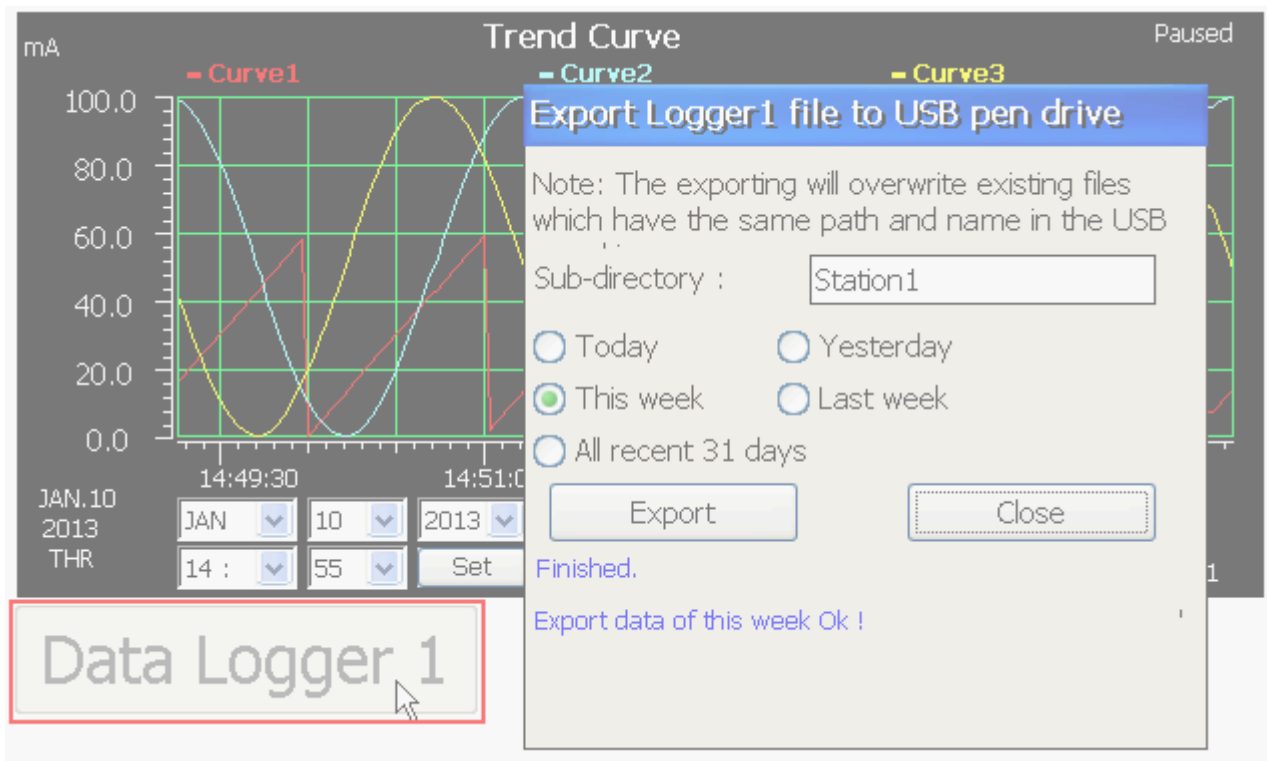

Appendix A Hardware System & Setting

A.1 Applying Correct Power Supply

Please apply a regular power supply between +10V ~ +30V (> 25W or higher is better) to ISaGRAF WinCE ViewPAC.

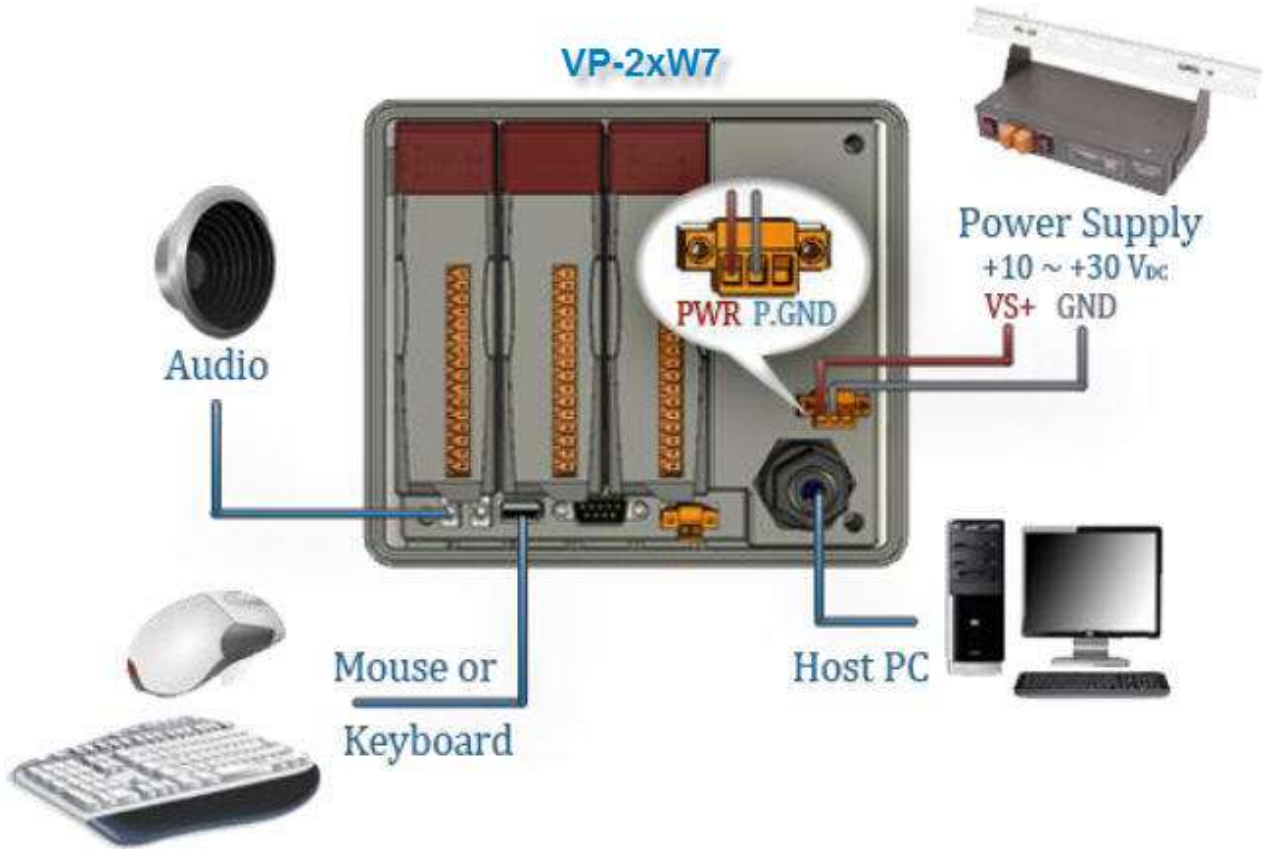

VP-2xW7	VP-4137
<p>+10 - 30 VDC PWR P.GND F.G. Power Input Frame Ground</p>	<p>+10 ~ +30 VDC P.PWR P.GND F.G. Power Input 1 Power Input 2 Frame Ground</p>

Options:

Power supply:

http://www.icpdas.com/root/product/solutions/accessories/power_supply/power_supply_selection.html

DP-660 :	24V/2.5A , 5V/0.5A power supply (DIN-Rail mounting)
DP-665 :	24V/2.5A , 5V/0.5A power supply
DP-1200 :	24V/5A power supply

Industrial Ethernet switch:

http://www.icpdas.com/root/product/solutions/industrial_ethernet_switch/switch_selection.html

NS-205:	10/100M , 5 ports
NS-208:	10/100M , 8 ports
RS-405:	10/100M , 5 ports (Ring Switch)
RS-408:	10/100M , 8 ports (Ring Switch)

A.2 Modify The NET-ID & Modbus RTU Port Setting

User may set ISaGRAF WinCE ViewPAC's Net-ID (Slave Number) to a No. from 1 to 255. The default Modbus RTU slave port is "None" when shipped out. User may set it to others depends on its application (please also refer to [appendix G](#) & [appendix E](#) for more Modbus RTU ports). Then please reset the ViewPAC once after the modification to make the new setting work.

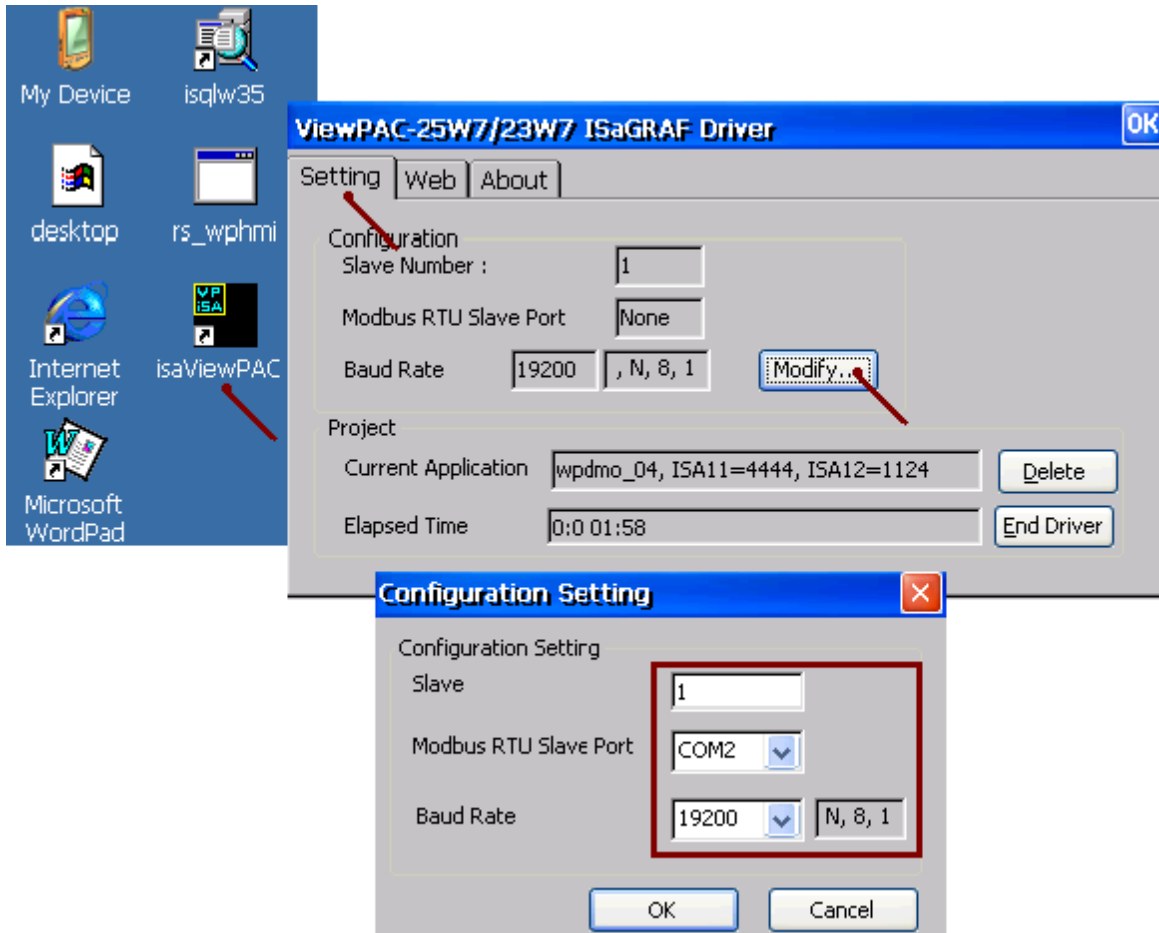

A.3 Setting The IP Address For The ViewPAC

Please run “Start” – “Setting” – “Control Panel” on the ViewPAC, then double click on “Network and Dial-up Connections”. Then click on “LAN1” . Set your ViewPAC’s IP address and its Subnet Mask. (Please always set as **Fixed IP** for ISaGRAF application, **No DHCP**)

Note:

Please refer to the [Appendix D](#) for enabling the 2nd Ethernet port of VP-2xW7/2xW6/4137/4136.

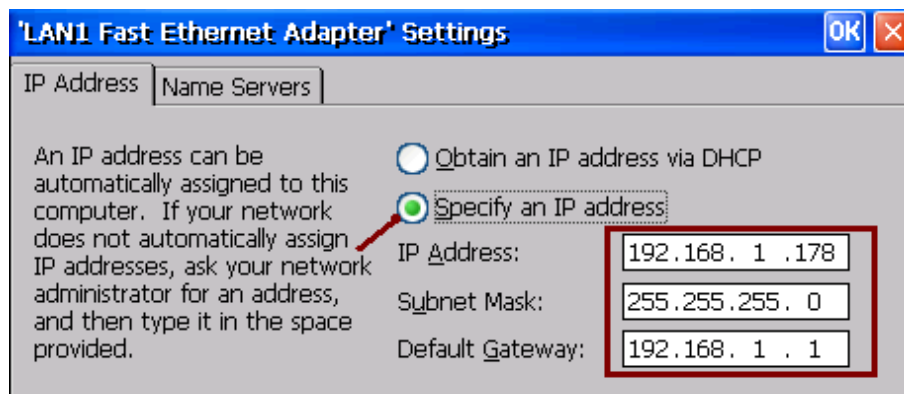

Please run “Start” – “Programs” – “ViewPAC Utility”, click on “Save and Reboot” to store the setting.

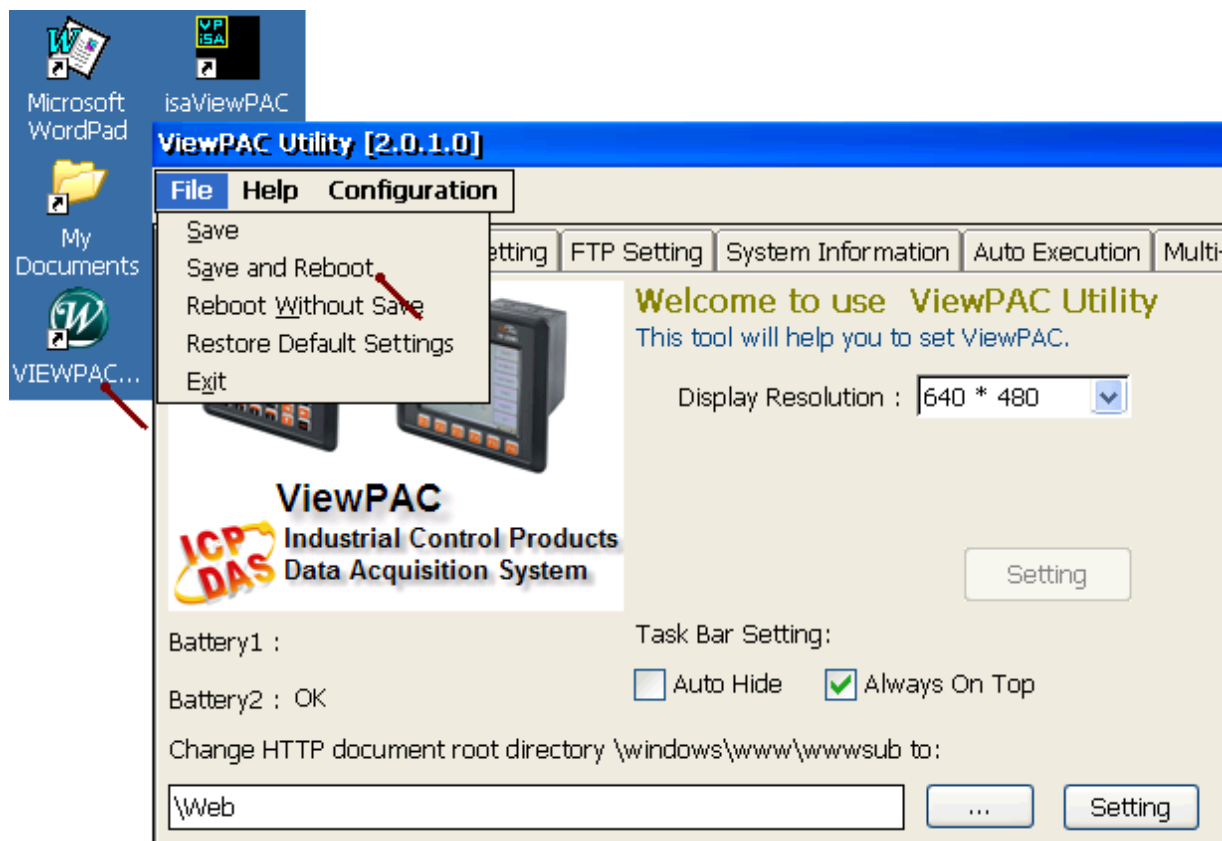

A.4 Connecting Your PC To The ViewPAC Ethernet Port

Before you can download an ISaGRAF application to the ISaGRAF WinCE ViewPAC controller using the Ethernet port, you must first setup the Ethernet port to properly communicate with the PC.

On the ViewPAC:

Set IP, Mask and Gateway address:

Please refer to former [section – “A.3: Setting The IP Address For The ViewPAC”](#)

On your PC:

First open an ISaGRAF project and select a program you wish to communicate between your PC and the ViewPAC controller system. Next, select the "Link Setup" button on the project screen as shown below.



A "PC-PLC Link Parameters" dialog box will appear as shown below. From here select the "Ethernet" communications option and click on the "Setup" button.

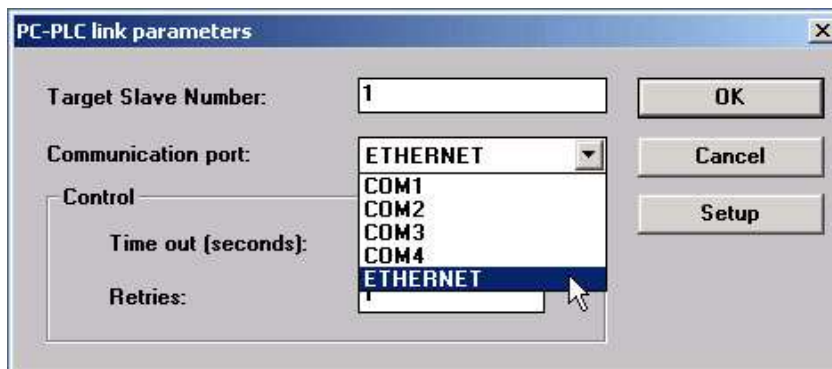

Once you have clicked on the "Setup" button, an "Ethernet Link Parameters" dialog box will appear. Set the "Port Number" to "502" and enter in the **Internet address (IP) of the ViewPAC controller**.

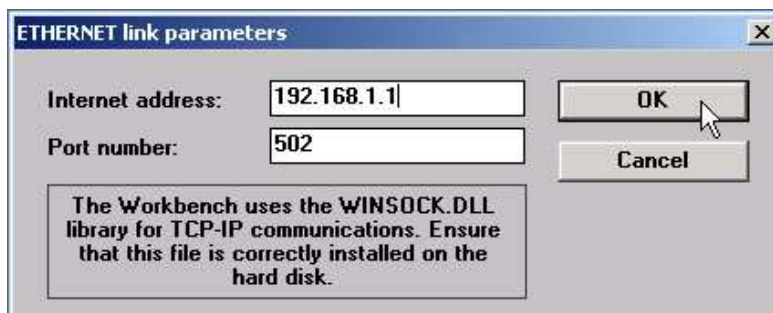

Once you have entered the appropriate information, click on the "OK" button, and now you have configured your PC to communicate with the ViewPAC through the Ethernet port.

A.5 Pin Assignment of COM2 , COM3 and Multi-Clients

Each ISaGRAF WinCE ViewPAC must use an IP address (**No DHCP**) and with a fixed Ethernet port **No. 502**. Up to 32 PCs can link to one ViewPAC by Ethernet (Modbus TCP/IP protocol, one TCP/IP connection for each PC). Other PC or HMI can link to COM3:RS-232 or COM2:RS-485 if one of them was set as Modbus RTU slave port (refer to [Appendix A.2](#)) (or link to its COM5 to COM8, refer to the [appendix G](#) & [appendix E](#))

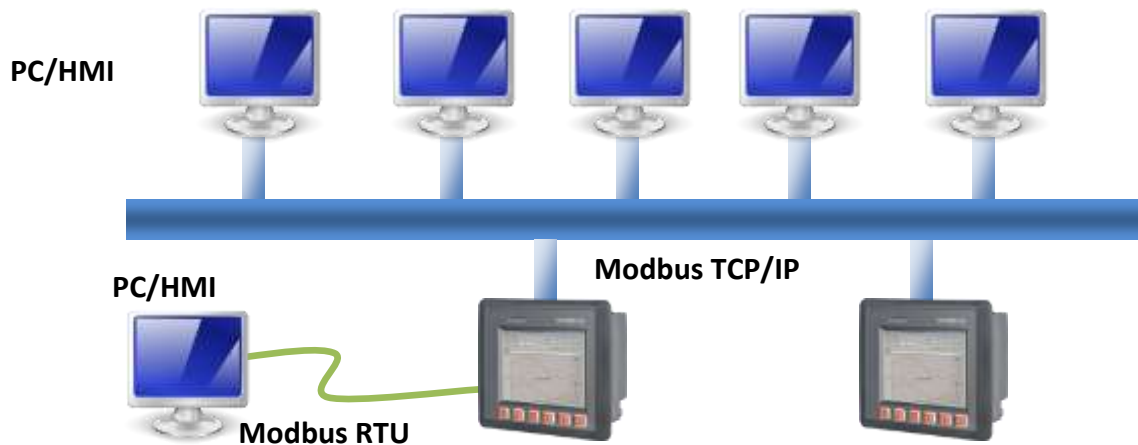

Options:

Industrial Ethernet switch:

http://www.icpdas.com/root/product/solutions/industrial_ethernet_switch/switch_selection.html

- NS-205: 10/100M , 5 ports
- NS-208: 10/100M , 8 ports
- RS-405: 10/100M , 5 ports (Ring Switch)
- RS-408: 10/100M , 8 ports (Ring Switch)

Pin Assignment of COM2 and COM3 :

VP-2xW7		VP-4xx7	
COM2 : RS-485	COM3 : RS-232	COM2 : RS-485	COM3 : RS-232
<p>RS-485</p>		<p>RS-485 ISO GND</p>	

A.6 Connecting PC To VP-2xW7 's COM2 or COM3

The default Modbus RTU slave port of ISaGRAF WinCE ViewPAC is “None”. User may change it to “COM2:RS-485” or “COM3:RS-232” or “None”. (please refer to [“A.2: Modify The NET-ID & Modbus RTU port setting”](#)). Please refer to [appendix G](#) & [appendix E](#) for more Modbus RTU ports. Default communication parameter is “19200,8,N,1”

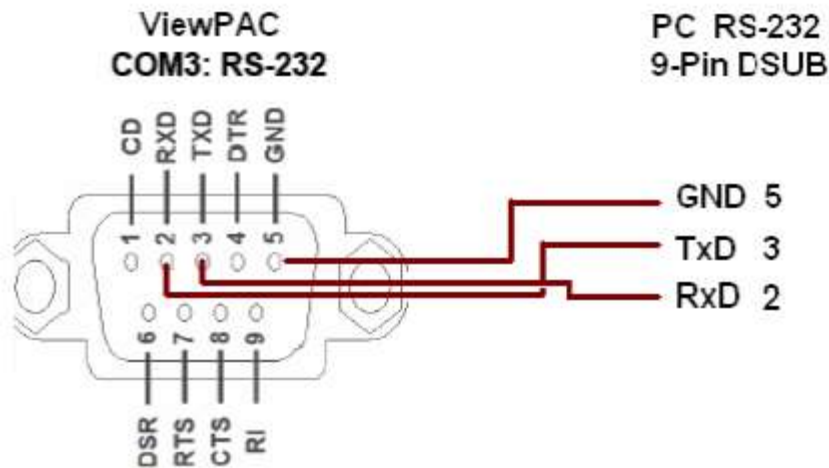

If connecting PC to ViewPAC 's COM2: RS-485, an I-7520 (RS-232/485 converter) is necessary as below.

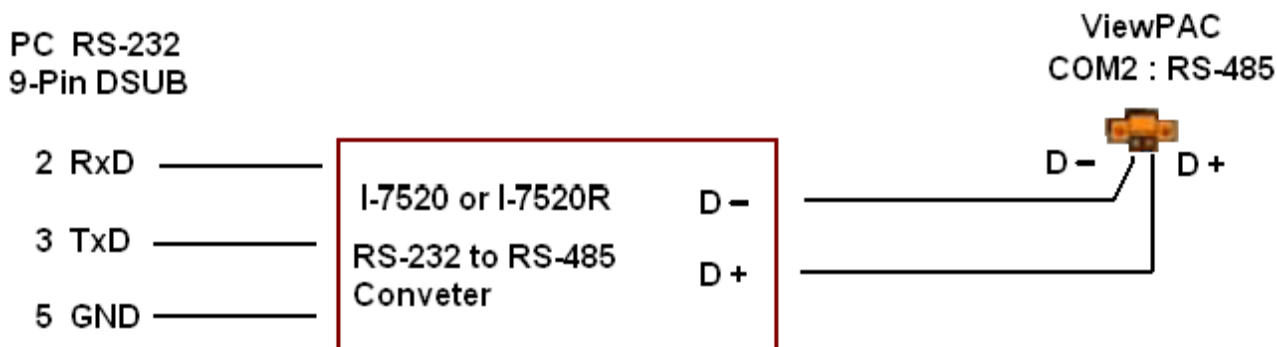

A.7 Deleting the ISaGRAF Project From The ViewPAC

For some reasons, user may delete the ISaGRAF program in the ViewPAC controller.

Click on “Setting” & then click on “Delete ISaGRAF Project”.

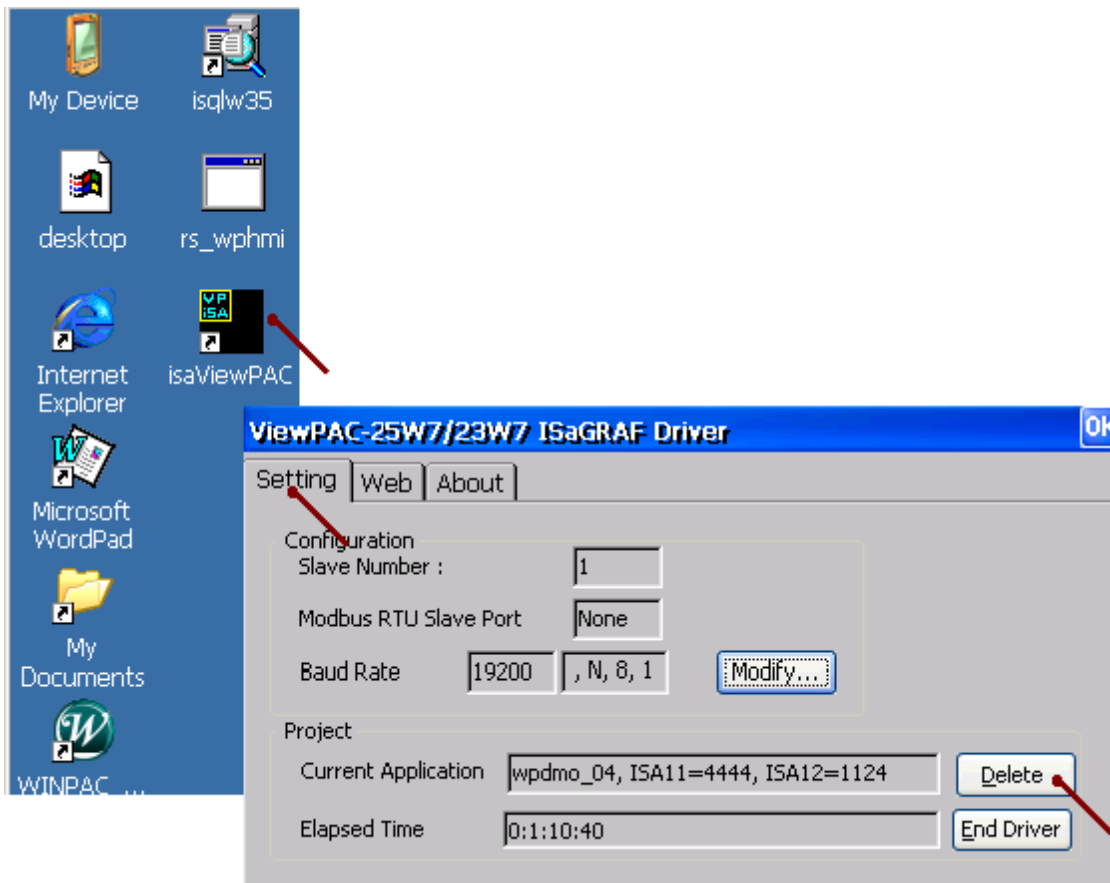

Delete ViewPAC's ISaGRAF program if some software damage happens causing the WinCE software hanging.

1. Please turn the rotary switch to position 1 (Safe mode) on the front panel of the ViewPAC. Then reset the ViewPAC once.
2. Then the ViewPAC will boot up as safe mode. There will be one pop-up window asking "... reboot right now ...", please answer "No". Then get into the "My Device" on the WinCE desktop. Please goto the "\System_Disk\isagraf\" directory. Then delete the "ISA11". The "ISA11" is the ISaGRAF current running application. (If you find no "ISA11" in the \System_Disk\isagraf\ directory, please goto Explorer > View > Options to modify the setting)
3. Turn the rotary switch to position 0 (normal), then reboot ViewPAC. Then when ISaGRAF is connected, it will display "No Application".

A.8 Linking I-7000 and I-87K Modules For Remote I/O

The ISaGRAF WinCE ViewPAC system can use its COM2:RS-485 (or COM3 + I-7520R) to link to ICP DAS's "I-7000" and "I-87K" series of remote I/O modules. This configuration can be very useful in applications that require distributed remote I/O throughout the system.

You can link up to **255** I-7000 or I-87K series remote modules to one ViewPAC controller system (It is better not to link up to 40 pcs. of I-7000 or I-87K). You must remember to set each I-7000 and I-87K remote module must have a unique address, and be set to the same baud rate as the ViewPAC controller system.

For more information regarding setting up and programming an I-7000 / I-87K remote module, please refer to Chapter 6 - "Linking To I-7000 and I-87K Modules" of the "User's Manual Of The ISaGRAF Embedded Controller" .

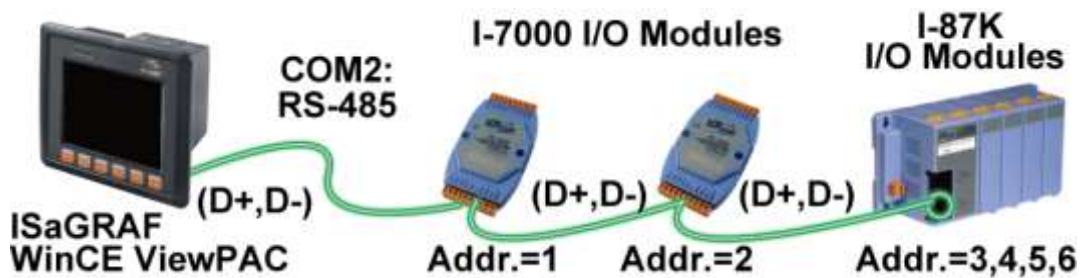

A.9 Linking To An HMI Interface Device

One of the COM2:RS-485 or COM3:RS-232 (or max. four of the COM5, 6, 7, 8, please refer to [appendix G](#) & [appendix E](#)) ports of the ISaGRAF WinCE ViewPAC controller system can be used to interface with additional Human Machine Interface (HMI) devices touch displays.

Please refer to [section A.2](#) first for setting Modbus RTU port at one of COM2 or COM3. ICP DAS provides a full line of touch screen displays, such as the "Touch" series screens. The models in the product line include the Touch 500, Touch 8000, Touch 6000 series products.

For more information regarding interfacing the Touch series of MMI devices to the ViewPAC controller system, please refer to Chapter 4- "Linking The I-8xx7 To HMI Devices" of the "User's Manual Of The ISaGRAF Embedded Controller" .

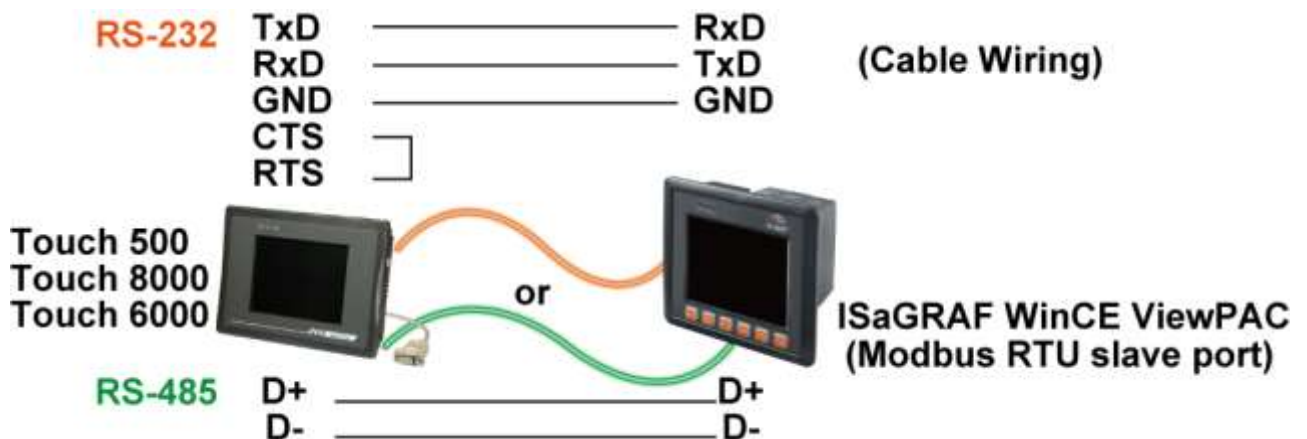

A.10 Linking To Other Modbus Devices

ISaGRAF WinCE ViewPAC's COM2: RS-485 or COM3: RS-232 (or COM5 to 14, refer to [appendix E](#)) supports Modbus Master protocol. Please refer to Chapter 8 of the "User's Manual Of The ISaGRAF Embedded Controllers" for more information.

RS-232:

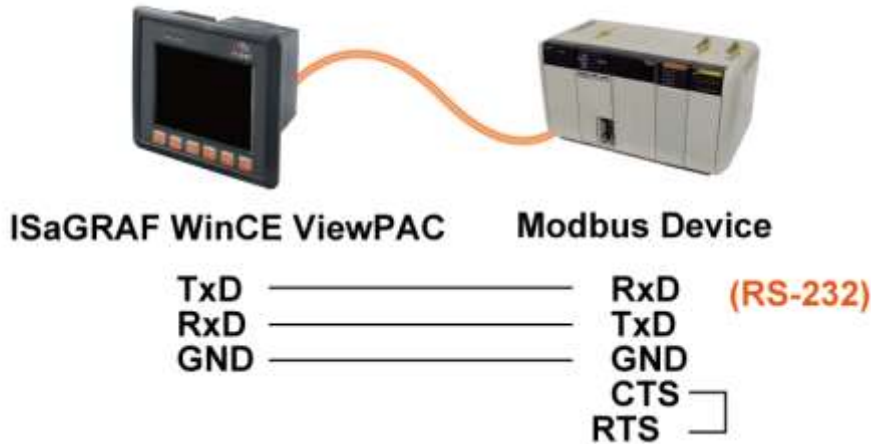

RS-485:

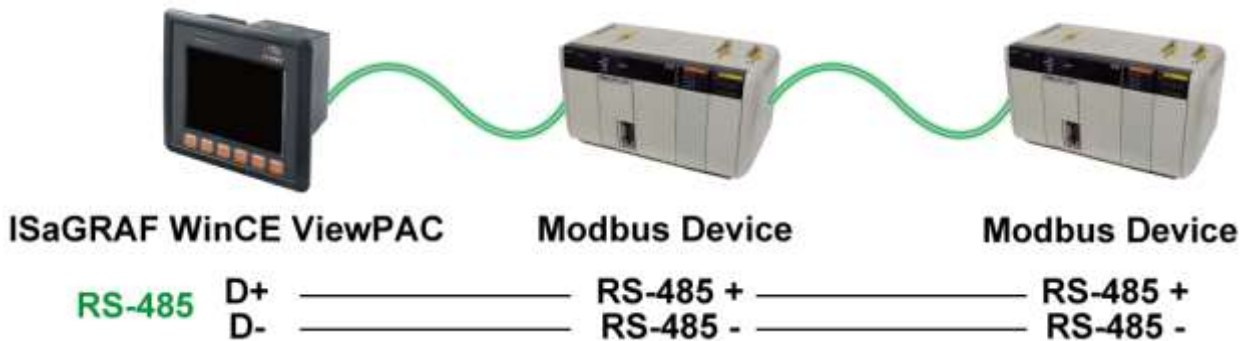

A.11 Recalibrate The Touch Screen Of VP-25W7

The touch screen has function with the default calibration. It is necessary to calibrate your screen when it works not precise.

The calibration process is different from the PCB version, so before starting the calibration process, you must first check with the PCB version, as follows:

The latest version - PCB 1.7 or later

If your PCB version is 1.7 or later, there is a rev number sticker between the I/O slots.

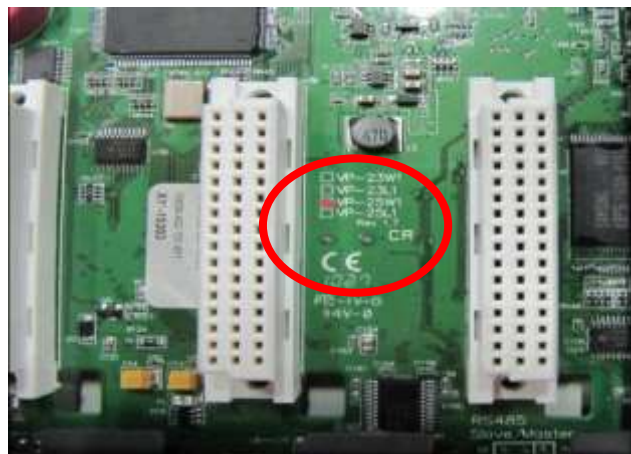

The earlier version - PCB 1.5

If your PCB version is 1.5, there is no rev number sticker between the I/O slots.

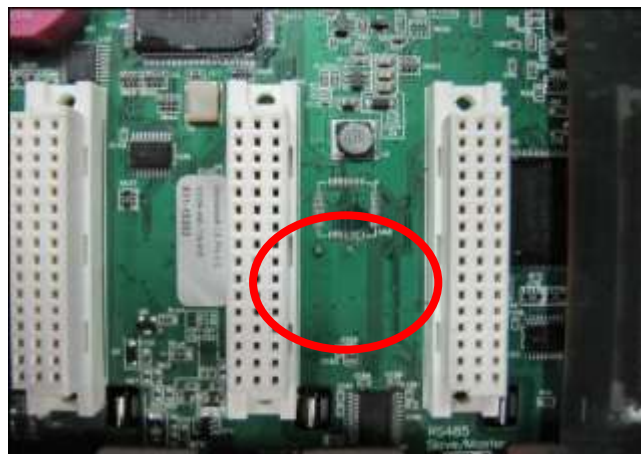

After checking the PCB version, then select the calibration process that corresponds to your PCB version.

The latest version (PCB 1.7 or later)

1) Run the Touch_calibrate



The earlier version (PCB 1.5)

1) Open the Control Panel



2) Click the 4 Points or the 9 Points button.

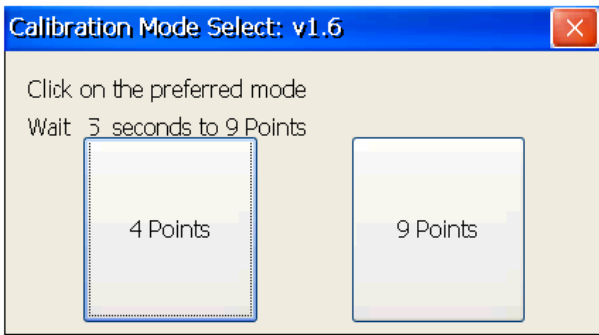

3) Tap the touch pen in the exact center of each of the calibration markers (+)

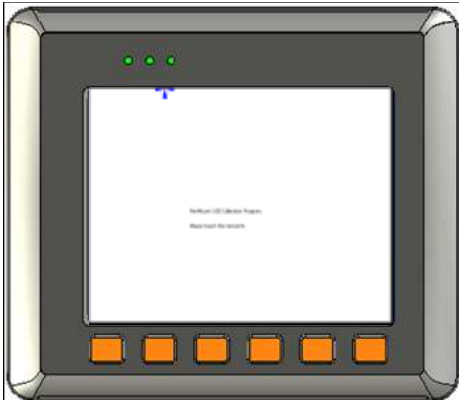

2) Run the Stylus.

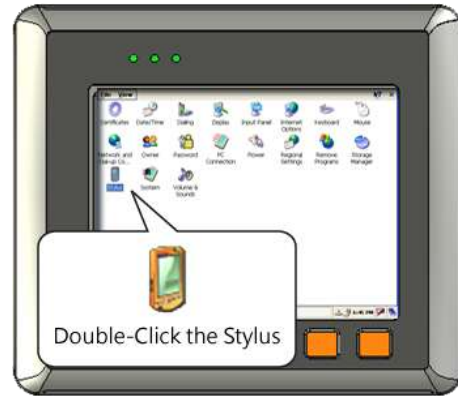

3) Tap the touch pen in the exact center of each of the calibration markers (+)

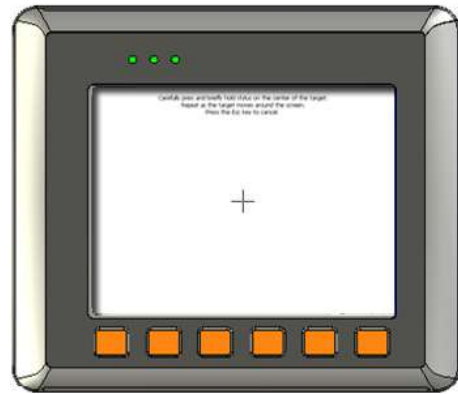

4) Touch the panel to finish the calibration program
5) Run the View PAC Utility to save the settings and reboot the View PAC

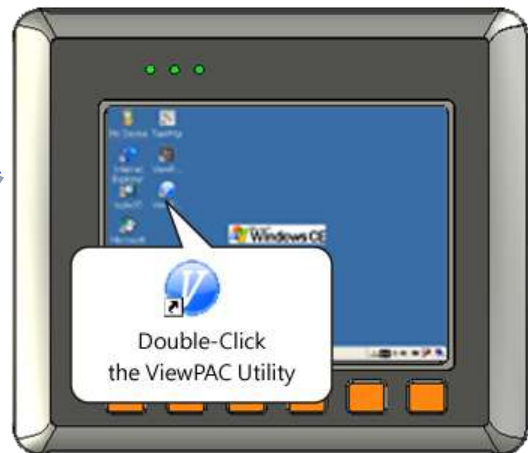
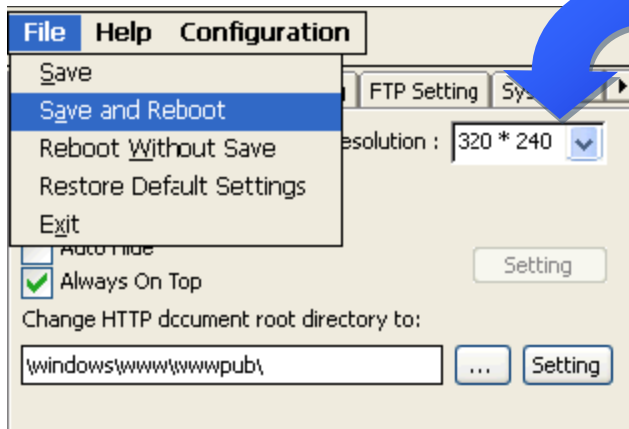

Appendix B Upgrade ISaGRAF Driver to Newer Version

Note:

If you have purchased ISaGRAF WinCE ViewPAC, the ISaGRAF Driver is already installed with a license when shipping out. You don't need to install it. However if you want to upgrade to newer version, you may upgrade it by yourself.

The ISaGRAF WinCE ViewPAC 's ISaGRAF driver can be obtained in the ISaGRAF WinCE ViewPAC CD-ROM:
\napdos\isagraf\vp-25w7-23w7\driver\<<version Number>\

For example, version 1.01 is located at

\napdos\isagraf\vp-25w7-23w7\driver\1.01\

Or download it from www.icpdas.com > Product > Solutions > Soft PLC, ISaGRAF & Soft-GRAF HMI > ISaGRAF > [ISaGRAF Download List > Driver](#)

1. If your ViewPAC is VP-2xW7/4xx7, please stop "ViewPAC-2xW7/4xx7 ISaGRAF Driver" first. (Click on "End Driver" to stop it.) However if it is VP-2xW1/4xx1 (ViewPAC without ISaGRAF license), please go to step 2.

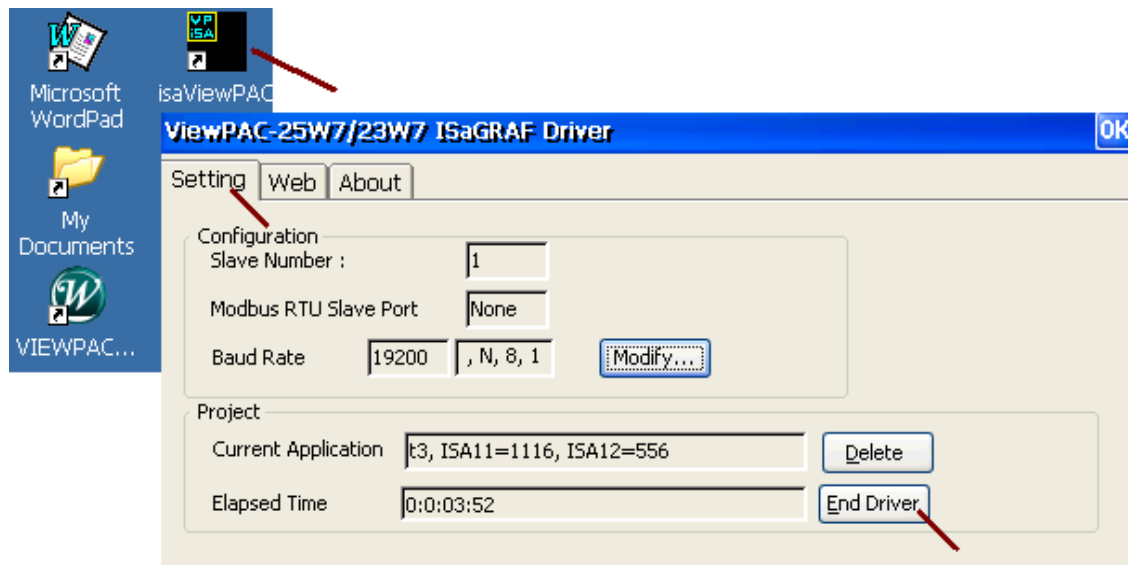

2. Set up ViewPAC 's IP, Mask, FTP directory & Auto-execute

- A. Please create a folder "isagraf" inside "\System_Disk" folder in your ViewPAC controller. Then it will be \System_Disk\isagraf\
- B. Please run "Start" – "Setting" – "Control Panel" on the ViewPAC, then double click on "Network and Dial-up Connections". Then click on "LAN1". Set your ViewPAC 's IP address & its Subnet Mask. (Please always set as **Fixed IP** for ISaGRAF application, **No DHCP**)

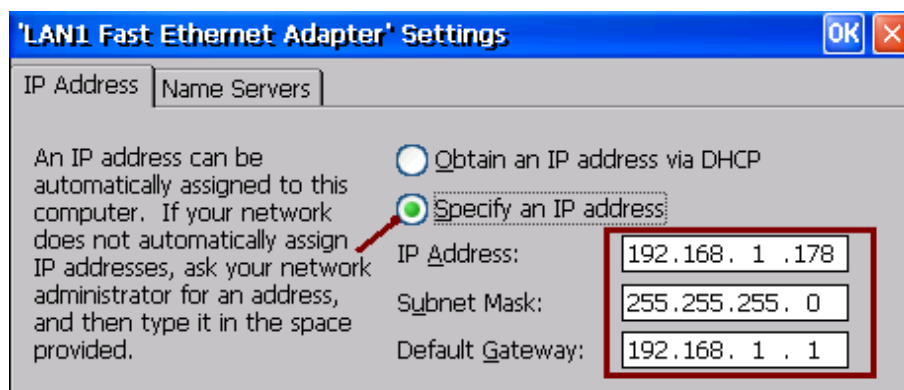

- C. Please run “Start” – “Programs” – “ViewPAC Utility”. Set FTP directory to the root directory “\”. Then check all three ftp options as “Enable”. Remember to click on “Setting”. Then click on “Auto Execution” to do the next step.

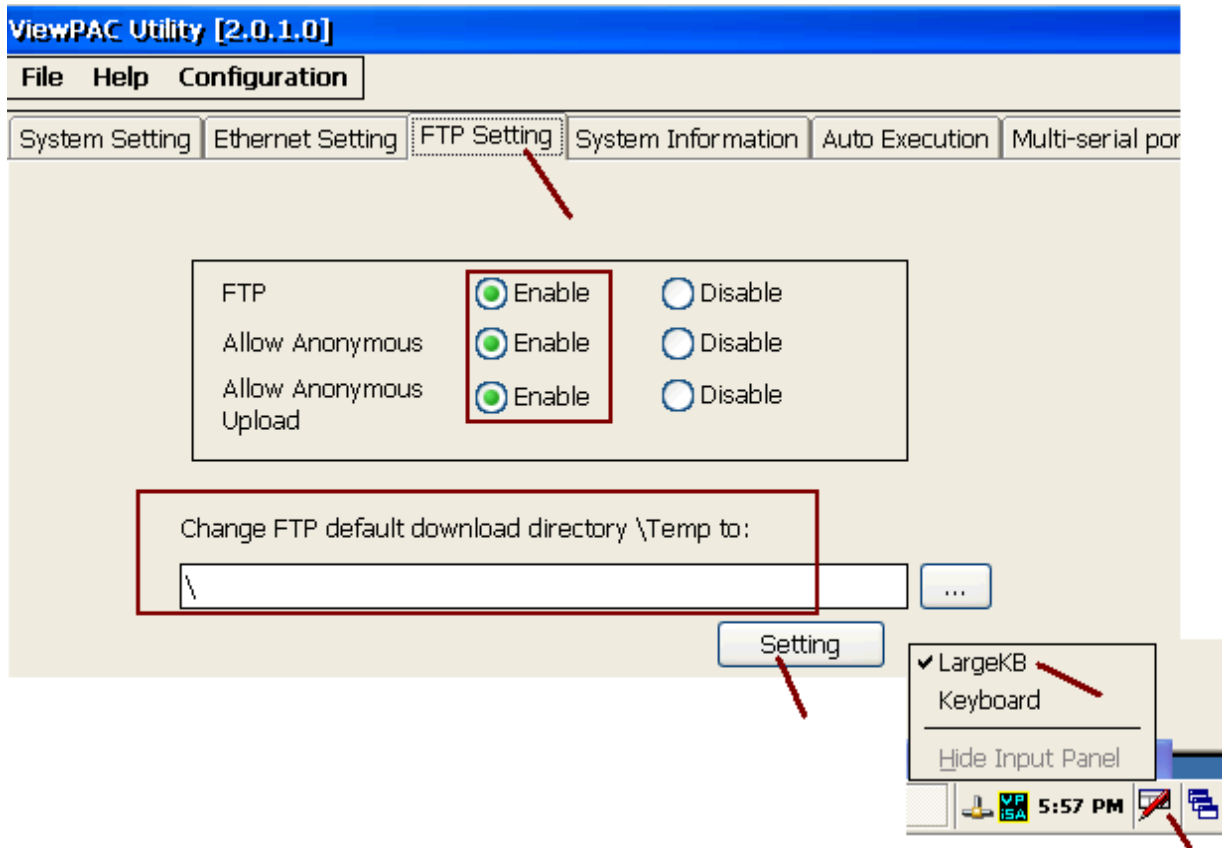

- D. Please click on “Browse” to select or type “\System_Disk\isagraf\isaViewPAC.exe” and click on “Setting”

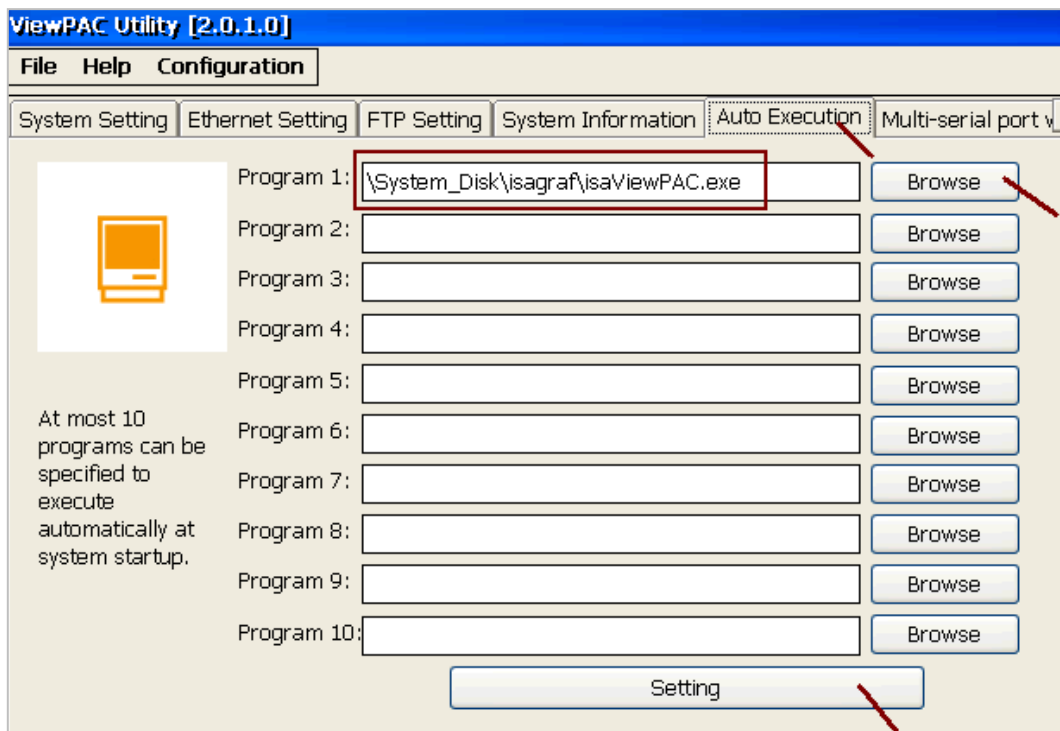

- E. Run "Save and Reboot" to store the setting in step A thru. D and then it will auto-reboot the ViewPAC once.

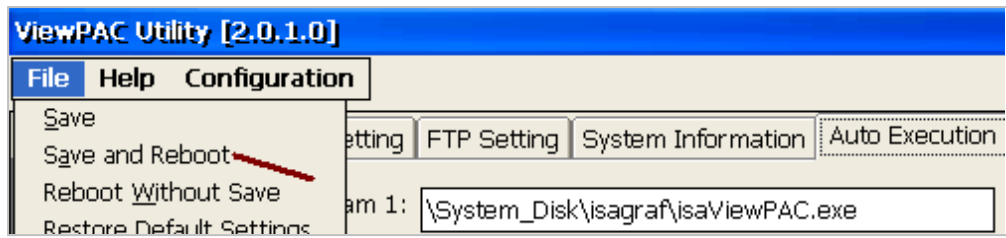

3. After the ViewPAC reboot successfully, please stop the ISaGRAF driver again. (The original VP-25W1 / 23W1 doesn't have the ISaGRAF driver running, only the VP-25W7 / 23W7 have it)

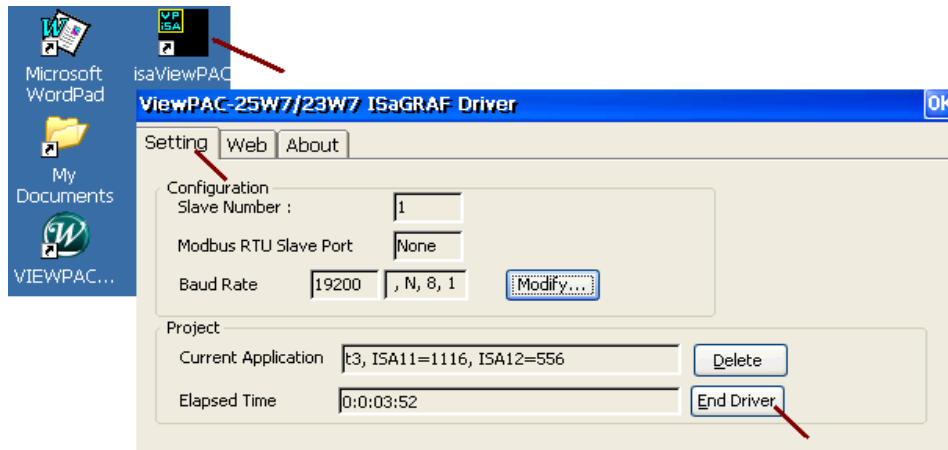

Note: If the ISaGRAF driver is still running, the files copied are failed even your eye telling you it is successful.

4. Download the files from PC to WinPAC directory "\\System_Disk\\isagraf\" :
(The files listed below are the driver of version 1.01. The files may different in different version.)

isaViewPAC.exe, rs_wphmi.exe
mscorlib.dll, QuickerNet.dll, Quicker.dll, login.dll, main.dll, whmi_filter.dll
isaViewPAC.lnk
(and "license.bin" if your ViewPAC is VP-2xW1/4xx1)

And then re-cycle your PAC's power.

Please open Internet browser and then type in <ftp://<IP address>>, for ex. [Ftp://192.168.1.178](ftp://192.168.1.178) , browse it to the \\System_Disk\\isagraf\\. Then copy all of them and past it.

Then remember to re-cycle your ViewPAC 's power again. After it re-boot again, it will have the new ISaGRAF driver running. You can check if the version is correct.

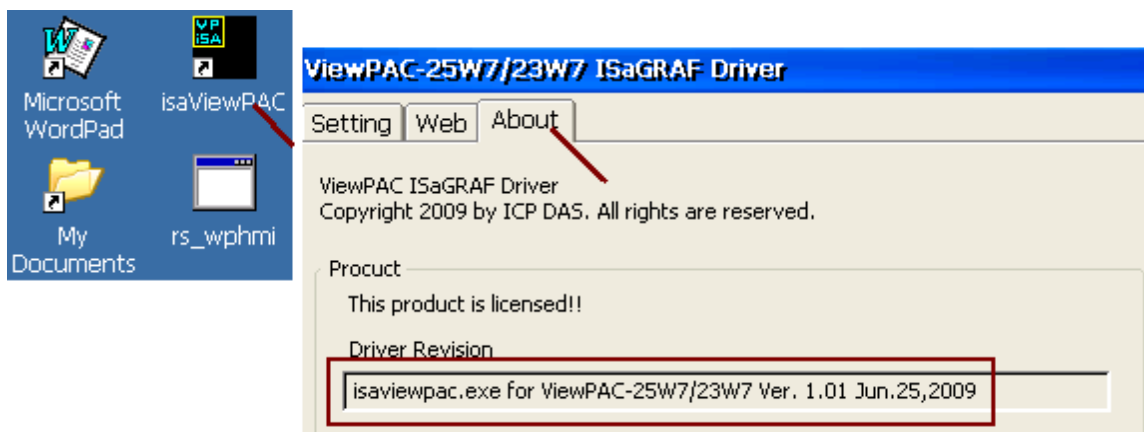

Appendix C Hardware Interface & Dimension

VP-23W7



VP-25W7



VP-23W7/25W7

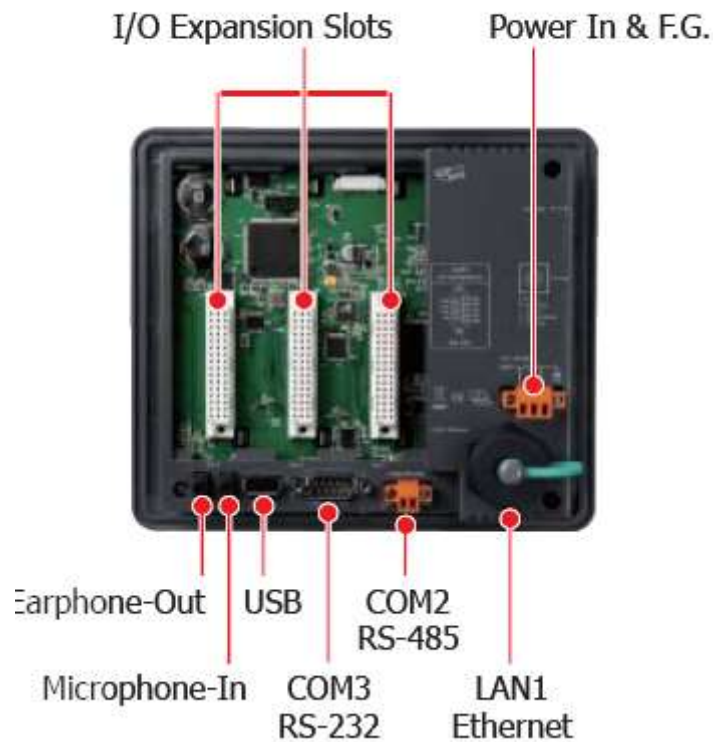

VP-23W7/23W6 (Unit: mm)

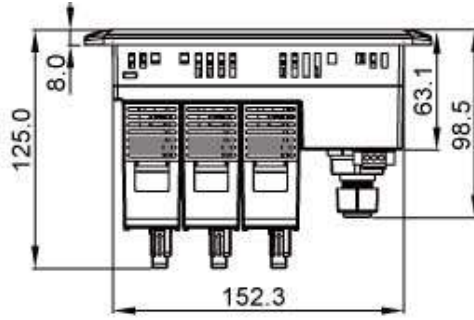

Top View

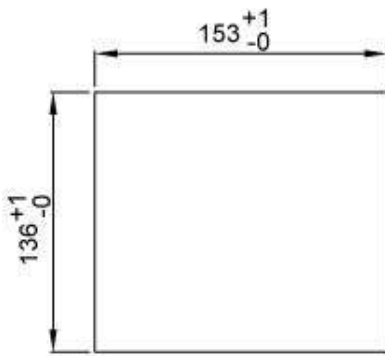

Recommended
Panel Cut-Out

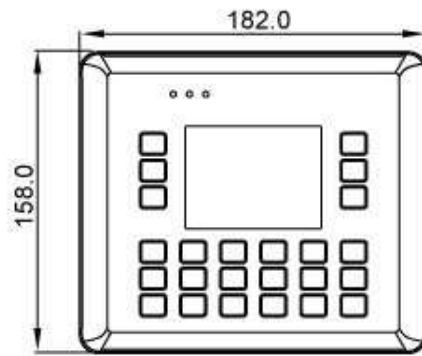

Front View

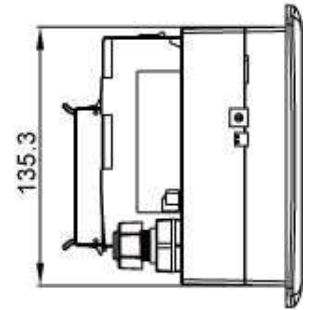

Right Side View

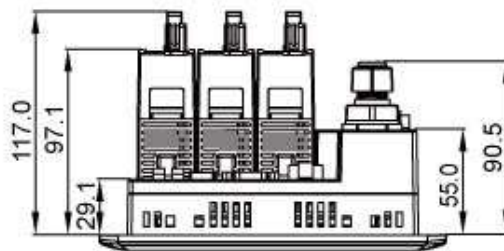

Bottom View

VP-25W7/25W6 (Unit: mm)

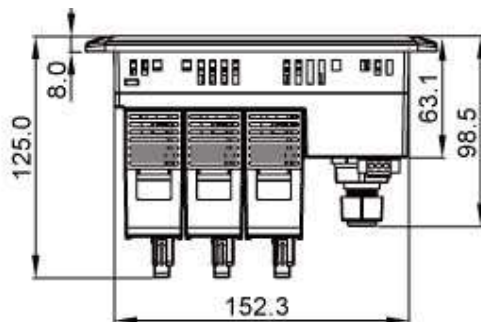

Top View

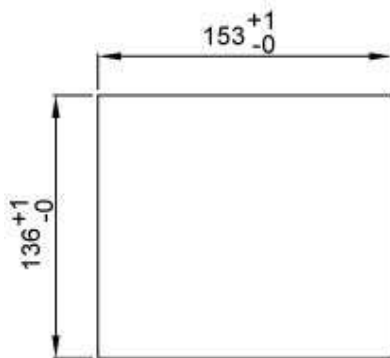

Recommended Panel Cut-Out

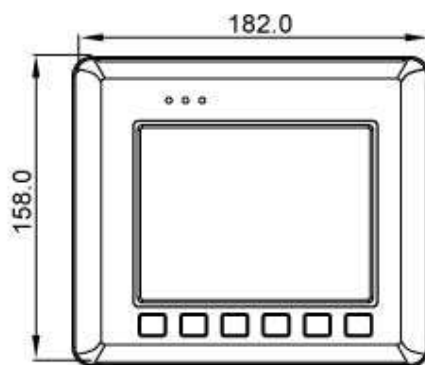

Front View

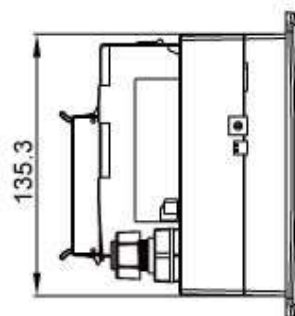

Right Side View

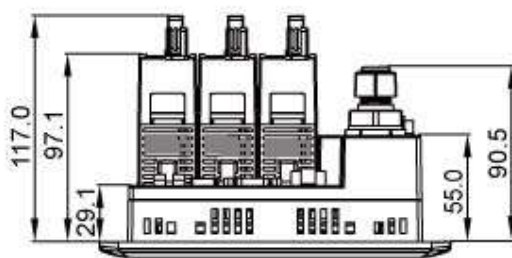

Bottom View

VP-4137



VP-4137

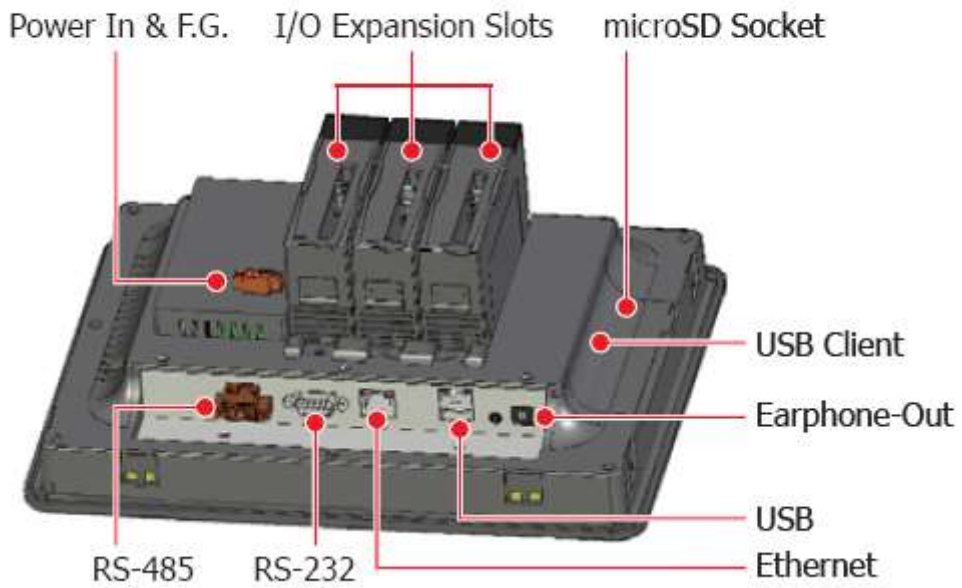

VP-41x7/41x6 (Unit: mm)

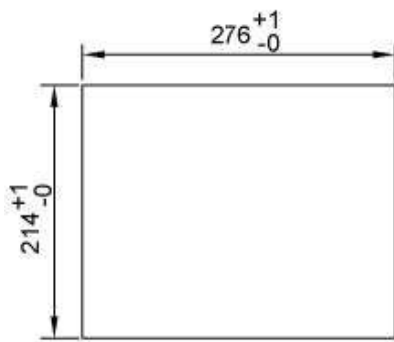
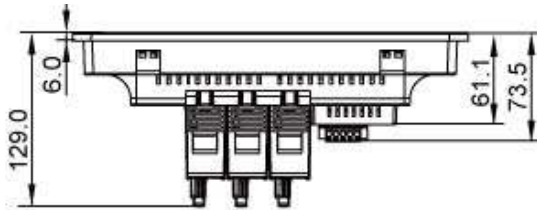

Recommended
Panel Cut-Out

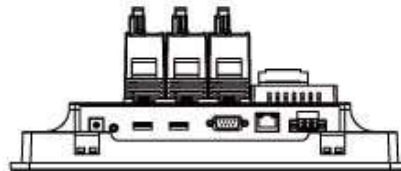
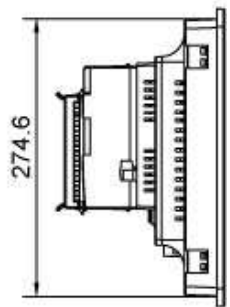
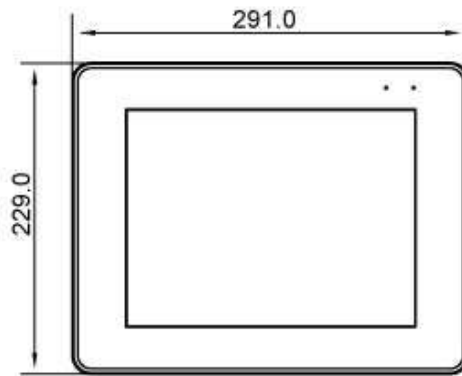

Appendix D Enable The Second Ethernet Port Of The VP-2xW7/2xW6/4137/4136

The VP-25W7/23W7/25W6/23W6/4137/4136 default has only one Ethernet port named "LAN1" . User can add one "I-8135W" card in the **slot 0** to expand the 2nd Ethernet port named "8135" . For example, the ISaGRAF WinCE ViewPAC redundant solution need the 2nd Ethernet port (Please refer to www.icpdas.com > [Support](#) > [FAQ](#) > [ISaGRAF Soft-Logic PAC](#) > [FAQ-093](#)).

To setup the second Ethernet port in the I-8135W, please follow below steps.

1. Power off the ViewPAC, then install the "I-8135W" card to ViewPAC 's slot **0** first.
2. Power on the ViewPAC, then run ViewPAC utility to enable the "8135" as below. (Please check "Use DHCP ..." first, we will modify it to be a fixed IP address later.) Remember to run "Save and Reboot" once to save the settings.

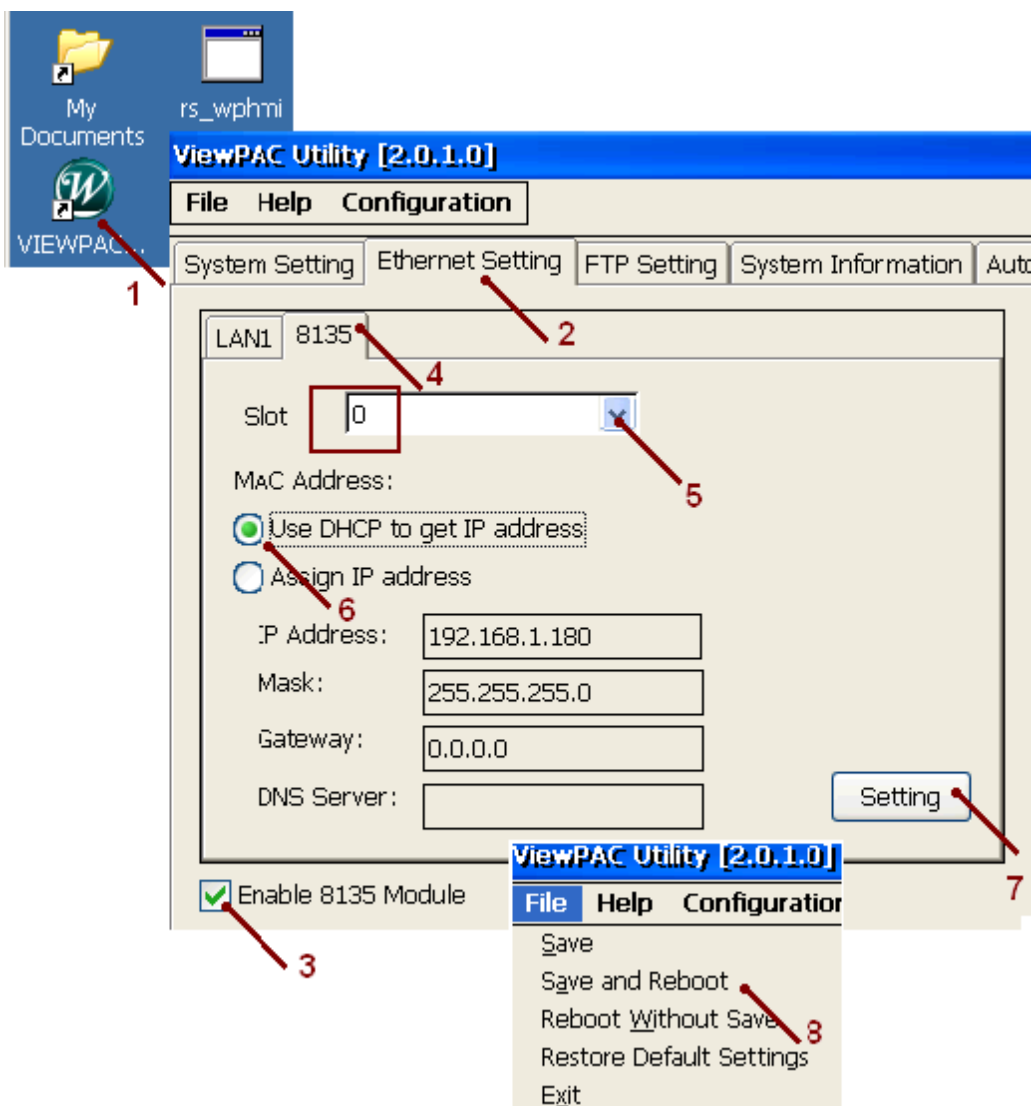

- Then run “Network and Dial-up Connections” as the figure in the next page to set “8135” Ethernet port to a fixed IP address. (ISaGRAF PAC can use only fixed IP, no DHCP). Then remember to run ViewPAC utility to “Save and Reboot” once to save the settings.

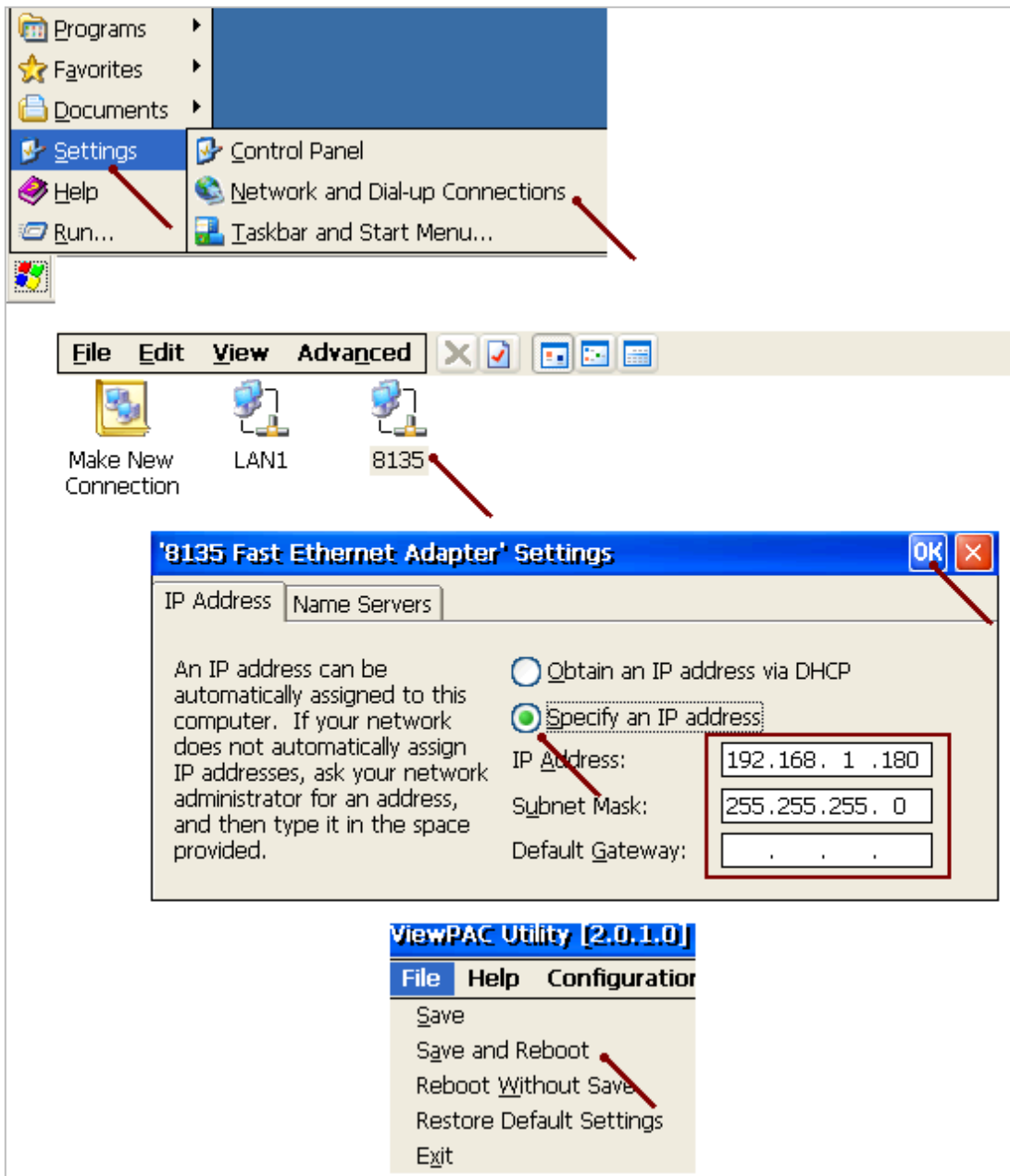

Note:

- ViewPAC 's Ebus is working on its first Ethernet port – the “LAN1”. This is un-like the WinPAC-8xx7 which is working on its “LAN2”.
- When program the “RDN_new” in VP-25W7/23W7/25W6/23W6/4137/4136, it is necessary to install the “I-8135W” in slot 0 and enable the 2nd Ethernet port to make it work. (Please refer to www.icpdas.com > [Support](#) > [FAQ](#) > [ISaGRAF Soft-Logic PAC](#) > [FAQ-093](#))
- When the 2nd Ethernet port is enabled, it default supports the Modbus TCP/IP slave protocols. The first and the 2nd Ethernet port can also support the “udp_ip” and “tcp_clie” to delivery data to PC / HMI or other devices. (Please refer to the section 19.2 and 19.3 of the ISaGRAF User's manual - ser_manual_i_8xx7.pdf” and “user_manual_i_8xx7_appendix.pdf”)

Appendix E Using Expansion RS-232/485/422

The ViewPAC can expand 12 more COM ports in its slot No. 0 to 2 by using following modules.
 (User can refer to www.icpdas.com > [Support](#) > [FAQ](#) > [ISaGRAF Soft-Logic PAC](#) > FAQ-159 to use the tGW-700 series of Modbus TCP / RTU / ASCII gateway to expand the Modbus master RS-232 / 485 / 422 port.)

I-8112iw	: 2-channel isolated RS-232
I-8114iW	: 4-channel isolated RS-232
I-8114W	: 4-channel non-isolated RS-232
I-8142iW	: 2-channel isolated RS-422/RS-485
I-8144iW	: 4-channel isolated RS-422/RS-485

Before user can use them, please configure them By the “ViewPAC utility” first. Please plug them in the ViewPAC 's slot 0 to 2 and then run “**ViewPAC utility**” > “Multi-serial port wizard”, then click on “Slot scan”. The current found multi-serial port cards will be listed on the left. The original COM port setting is listed on the right. Then click “Set” to update the original setting to become the current found cards. Then remember to run “File” > “Save and Reboot” to save the new setting and then ViewPAC will re-boot itself once.

After the configuration is succeed, the COM port No. for the expansion board is COM5 to COM16 in the ISaGRAF definition.

The relation between ViewPAC 's COM setting and the ISaGRAF definition is as the following.

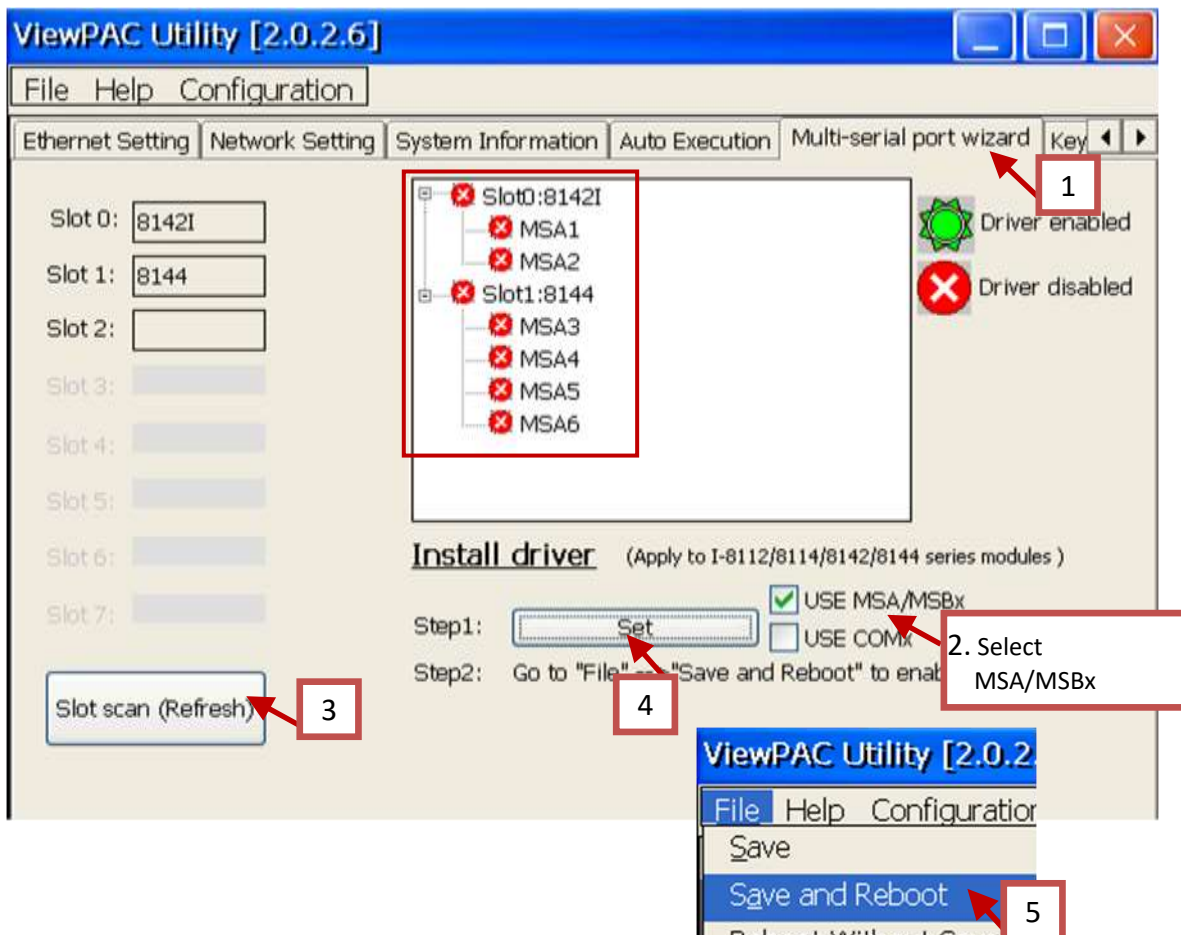

ViewPAC	ISaGRAF	ViewPAC	ISaGRAF
MSA1	COM5	MSA7	COM11
MSA2	COM6	MSA8	COM12
MSA3	COM7	MSB1	COM13
MSA4	COM8	MSB2	COM14
MSA5	COM9	MSB3	COM15
MSA6	COM10	MSB4	COM16

Example of slot 0: i-8142iW
and slot 1: i-8144iW

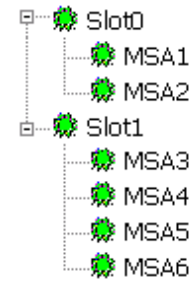

Note:

1. Please refer to the section 8.4 of the ISaGRAF User’s Manual for multi-ports Modbus Master. (ISaGRAF WinCE ViewPAC can setup max. 10 Modbus RTU / ASCII Master ports in COM1 to 14)
2. Please refer to the Appendix A.4 of the ISaGRAF User’s Manual for COM_OPEN, COM_READ, ... functions to read / write COM ports.
3. Please refer to [Appendix G](#) of this manual for setting up more Modbus RTU slave ports.

Pin assignment:

i-8112iW 2-Ch. RS-232			i-8114W / i-8114iW 4-Ch. RS-232		
Pin Assignment Name	Terminal No.	Pin Assignment Name	Pin Assignment Name	Terminal No.	Pin Assignment Name
GND1	05	09	RI1	20	RI3
DTR1	04	08	CTS1	21	DTR3
TxD1	03	07	RTS1	22	DSR3
RxD1	02	06	DSR1	23	RTS3
DCD1	01			24	TxD3
				25	DCD4
				26	GND
				27	CTS4
				28	RxD4
				29	RI2
				30	DTR2
				31	DSR2
				32	RTS2
				33	TxD2
				34	DCD1
				35	GND
				36	CTS1
				37	RxD1

DB-9 Male Connector(Port1)

DB-9 Male Connector(Port2)

37-Pin Female D-Sub Connector(Port1~Port4)

i-8142iW





















2-Ch. RS-422 / RS-485

RS-485 Ch.1 = (D1+ , D1-)

RS-485 Ch.2 = (D2+ , D2-)

RS-422 Ch.1 = (TxD1+ , TxD1- , RxD1+ , RxD1-)

RS-422 Ch.2 = (TxD2+ , TxD2- , RxD2+ , RxD2-)

Terminal No.	Pin Assignment Name
 01	D1+/TxD1+
 02	D1-/TxD1-
 03	RxD1+
 04	RxD1-
 05	GND1
 06	D2+/TxD2+
 07	D2-/TxD2-
 08	RxD2+
 09	RxD2-
 10	GND2
 11	N.C.
 12	N.C.
 13	N.C.
 14	N.C.
 15	N.C.
 16	N.C.
 17	N.C.
 18	N.C.
 19	N.C.
 20	N.C.

i-8144iW

4-Ch. RS-422 / RS-485

RS-485 Ch.1 = (D1+ , D1-)

RS-485 Ch.2 = (D2+ , D2-)

RS-485 Ch.3 = (D3+ , D3-)





















RS-485 Ch.4 = (D4+ , D4-)

RS-422 Ch.1 = (TxD1+ , TxD1- , RxD1+ , RxD1-)

RS-422 Ch.2 = (TxD2+ , TxD2- , RxD2+ , RxD2-)

RS-422 Ch.3 = (TxD3+ , TxD3- , RxD3+ , RxD3-)

RS-422 Ch.4 = (TxD4+ , TxD4- , RxD4+ , RxD4-)

Terminal No.	Pin Assignment Name
 01	D1+/TxD1+
 02	D1-/TxD1-
 03	RxD1+
 04	RxD1-
 05	GND1
 06	D2+/TxD2+
 07	D2-/TxD2-
 08	RxD2+
 09	RxD2-
 10	GND2
 11	D3+/TxD3+
 12	D3-/TxD3-
 13	RxD3+
 14	RxD3-
 15	GND3
 16	D4+/TxD4+
 17	D4-/TxD4-
 18	RxD4+
 19	RxD4-
 20	GND4

Appendix F Slow Down ISaGRAF Driver's Speed

You may wonder Why ? The faster speed is not good ?

The reason to slow down the speed of ISaGRAF driver is when you running some other HMI program (For example, InduSoft, VB.NET or C#.NET program) with ISaGRAF at the same time. Because the CPU is the only one CPU, all program running in ViewPAC must share execution time of the same CPU. If you feel the HMI program behavior is not so smooth, or slow, you may use ISaGRAF function – "PLC_Mode()" to slow down the speed of the ISaGRAF driver.

PLC_Mode

Description:
Function

Change the ISaGRAF driver speed

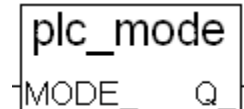

Argument:

MODE_ integer Can be 0 , 1, 2, or 3

- 0: Fast Mode, Default setting, the minimum PLC scan time is about 2 ~ 3 ms
- 1: Slow Mode, the minimum PLC scan time is about 6 to 7 ms
- 2: Slower Mode, the minimum PLC scan time is about 9 to 11 ms
- 3: or other value: Slowest Mode, the min. PLC scan time is about 19 ~ 21 ms

Return:

Q_ Boolean always return True

Note:

1. The system's default setting is "Fast Mode"
2. User may call "PLC_mode()" in the first PLC scan to change the PLC speed.
3. The reason to slow down the PLC speed is to improve the speed performance of other HMI program running with ISaGRAF driver at the same time. For example, running InduSoft with ISaGRAF in the same ViewPAC.

Example:

```
(* TMP is declared as Boolean internal variable *)
(* INIT is declared as Boolean internal variable and init at TRUE *)

if INIT then
  INIT := False ;          (* Only do it once in the 1st PLC scan *)
  TMP := PLC_mode(2) ;    (* Set PLC speed to 2:slower mode *)
end_if ;
```

Appendix G Setup More Modbus RTU Slave Ports

The ISaGRAF WinCE ViewPAC can setup up to five Modbus RTU slave ports in one of the COM2 or COM3, and in four of the COM5, COM6, COM7, COM8 (expansion multi-serial ports in slot 0 to 2, refer to the [appendix E](#)).

1. The 1st Modbus RTU slave port can be one of the COM2 or COM3 which can be set on the "ViewPAC's monitor" (refer to the [appendix A.2](#)).
2. User may enable 2nd, 3rd, 4th or 5th Modbus RTU slave port in COM5, COM6, COM7 or COM8. (No support other COM port number)
3. Before using this function in COM5 to 8, please make sure COM5, COM6, COM7, COM8 do exist and well configured. (Refer to the [appendix E](#))
4. Via 2nd, 3rd, 4th or 5th Modbus RTU slave port, user may use ISaGRAF to Debug / Set_val to the controller, however user cannot Stop / Download / Update the ISaGRAF program.
5. To Debug / Set_val / Stop / Download / Update the ISaGRAF program, please use Ethernet port (or the first Modbus RTU slave port, that is COM2 or COM3 if enabled). COM5 to COM8 are not for ISaGRAF to Stop / Download / Debug.

How to setup ?

Please connect "Rtu_slav" in the ISaGRAF IO connection window. Re-compile the project and download to the ViewPAC via Ethernet (or first Modbus RTU port if it is enabled)

The screenshot displays the ISaGRAF software interface. The main window is titled "ISaGRAF - T1 - Programs" and shows a menu bar (File, Make, Project, Tools, Debug, Options, Help) and a toolbar. Below the toolbar is the "ISaGRAF - T1 - I/O connection" window, which contains a list of ports and their configurations. The "rtu_slav" port is selected. The configuration for "rtu_slav" is as follows:

Port	Slave Port	Baud Rate	Reserved	Enabled
0	Rtu_Slave_Port2 = 5	Baud_Port2 = 19200	reserved = 0	<input checked="" type="checkbox"/>
1	Rtu_Slave_Port3 = 0	Baud_Port3 = 19200	reserved = 0	<input type="checkbox"/>
2	Rtu_Slave_Port4 = 0	Baud_Port4 = 19200	reserved = 0	<input type="checkbox"/>
3	Rtu_Slave_Port5 = 0	Baud_Port5 = 19200	reserved = 0	<input type="checkbox"/>
4	reserved = 0	reserved = 0	reserved = 0	<input type="checkbox"/>
5	reserved = 0	reserved = 0	reserved = 0	<input type="checkbox"/>
6	reserved = 0	reserved = 0	reserved = 0	<input type="checkbox"/>
7	reserved = 0	reserved = 0	reserved = 0	<input type="checkbox"/>
8	reserved = 0	reserved = 0	reserved = 0	<input type="checkbox"/>

The "Select board/equipment" dialog is also visible, showing a list of hardware options. The option "rtu_slav: 2nd ~ 5th Modbus RTU slave port" is selected. The dialog also includes buttons for "OK", "Cancel", and "Note", and a "Library" section with radio buttons for "Boards" and "Equipments".

The 4-ch Boolean inputs indicate the related port is well enabled or not. True: Enable Ok. False: Disabled.

RTU_Slave_Port2 ~ 5 defines the COM Port number to enable. Value can be 0, 5, 6, 7, or 8. Value of 0 means not enable it. Baud rate setting can be 600, 1200, 2400, 4800, 9600, 19200, 38400, 57600, 115200

Appendix H Compiling Error Result In Different ISaGRAF Version

In the recent years since 2003, all the ISaGRAF example programs provided in the ICP DAS CD-ROM & Web site are written in ISaGRAF workbench version of 3.46. If your ISaGRAF workbench is version of 3.51 or newer version, it may generate error when you re-compile these example programs.

To erase this kind of error in different ISaGRAF workbench version, please run “Make” – “Touch” once. And then re-compile this example project.

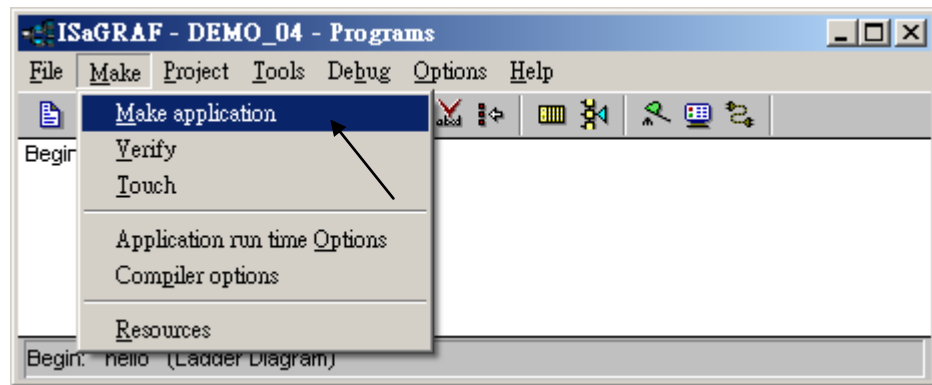
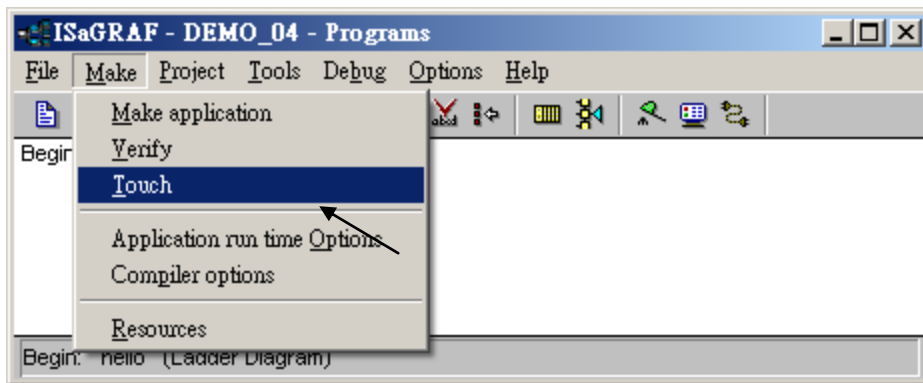

The “Make” – “Touch” command will reset all files that have been successfully compiled to become “Not compiled yet”. Then the next “Make” – “Make application” command will re-compile all of them.

Appendix I Why my PC running ISaGRAF cannot connect the ISaGRAF PAC correctly ?

The document can also be download at www.icpdas.com > [Support](#) > [FAQ](#) > [ISaGRAF Soft-Logic PAC](#) > 104.

Sometimes when using the PC / ISaGRAF debugger to connect to the ISaGRAF controller will pop-up a window like “Can not link ...” or “Can not download” or “Can not find BMP ...” or ...

To solve this problem, please do below steps.

1. First close all ISaGRAF windows. Then press and hold on “Ctrl” plus “Alt” key and then press “Delete” key to open the Task Manager.
2. Stop the process which is with empty memory. Then run PC/ISaGRAF again to connect to the controller.

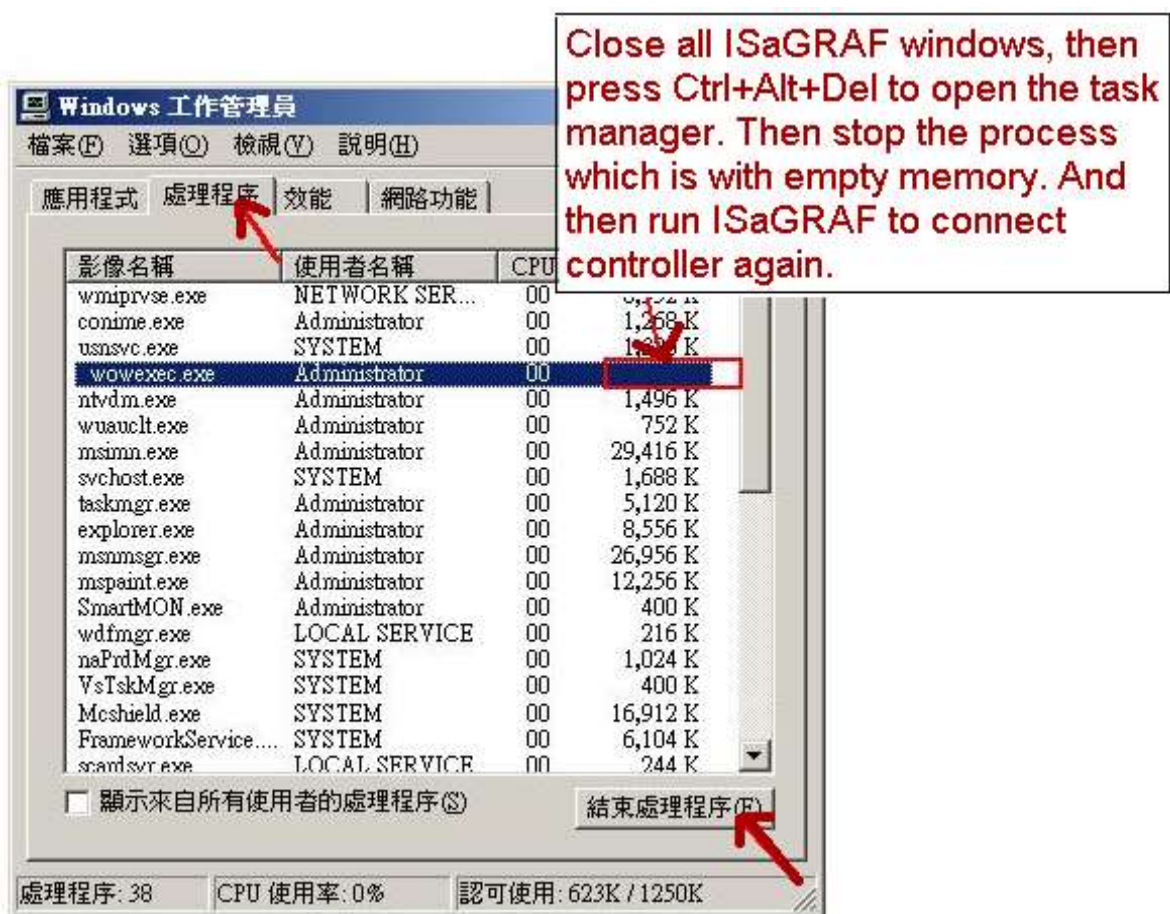

3. If the problem is still there and you are using Ethernet to connect the controller, check if your PC and controller are set in the same IP domain. For example, PC with (IP, Mask) = (192.168.1.2, 255.255.255.0) cannot connect controller = (192.168.3.5, 255.255.255.0). However it can connect the controller = (192.168.1.5, 255.255.255.0) well.
4. If the problem is still there and you are using RS-232 to connect the controller, check if your RS-232 cable is correct and check if you are setting the correct PC RS-232 port number to connect the controller.
5. The last way is re-start your PC and try again.

Appendix J Control Buttons On the Front Panel

ViewPAC has built some buttons on its front panel. These buttons is useful in some applications. To get the state of these buttons, please use the "EEP_B_R" function to read them. For example, user may write a ST program as below to read the state of "F1" , "F2" , "F3" , "F4" , F5" and "F6" buttons.

```
(* "F1_btn" , "F2_btn", ..., "F6_btn" are declared as Boolean / Internal variables
The following EEP_B_R( ) returns True if the related button is pressed.
The following EEP_B_R( ) returns False if the related button is released.. *)
```

```
(* True means pressed, False means released *)
```

```
F1_btn := EEP_B_R( 16#A00F1 ) ;
F2_btn := EEP_B_R( 16#A00F2 ) ;
F3_btn := EEP_B_R( 16#A00F3 ) ;
F4_btn := EEP_B_R( 16#A00F4 ) ;
F5_btn := EEP_B_R( 16#A00F5 ) ;
F6_btn := EEP_B_R( 16#A00F6 ) ;
```

The "EEP_B_R(ADR_)" definition for ViewPAC 's buttons:

ADR_ :

16#A00F1 (F1)	, 16#A00F2 (F2)	, 16#A00F3 (F3)
16#A00F4 (F4)	, 16#A00F5 (F5)	, 16#A00F6 (F6)
16#A0030 (0)	, 16#A0031 (1)	, 16#A0032 (2)
16#A0033 (3)	, 16#A0034 (4)	, 16#A0035 (5)
16#A0036 (6)	, 16#A0037 (7)	, 16#A0038 (8)
16#A0039 (9)		
16#A006E (.)	, 16#A000D (Enter)	
16#A0008 (BackSpace)	, 16#A0010 (Shift)	
	,	
16#A0025 (Left)	, 16#A0026 (Up)	
16#A0027 (Right)	, 16#A0028 (Down)	

Appendix K Enable the Screen Saver of ViewPAC

Please set the following two items to enable the screen saver of the ViewPAC.

In the **“Control Panel” > “Power” > “Schemes”**, please select “Power Scheme” as “AC power” and then set both “User Idle” and “System Idle” to the same value (or setting the “System Idle” value larger than the “User Idle” value) and then remember to run **“ViewPAC Utility” > “File” > “Save”** and Reboot. The ViewPAC will turn off the backlight when time is up if user doesn't touch it (screen and pushbuttons).

Then after in any time if user touches the screen or pushbutton, the ViewPAC will turn on the backlight again.

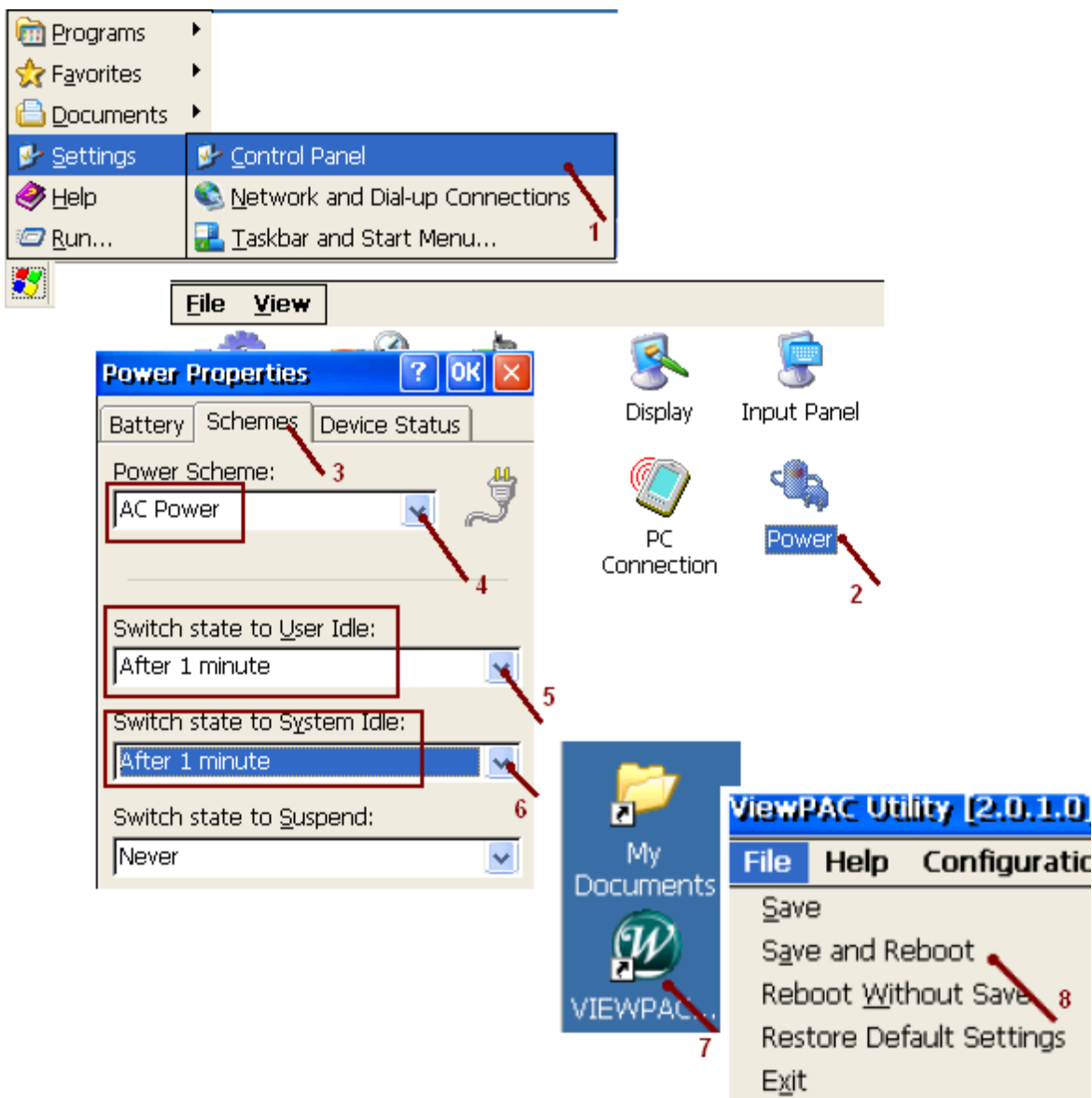

To disable the screen saver, please set both “User Idle” and “System Idle” to “Never” and then remember to run ViewPAC Utility > “File” > “Save and Reboot”.

Appendix L How to Detect the Status of Dual Battery and the Ethernet Port

NOTICE:

Please power off the Controller before replacing the battery; it may cause permanent damage if the battery accidentally touches other metal electronic parts.

The ViewPAC equips a 512 KB SRAM with dual battery design to retain the data even in the case of total power loss. This dual battery design allows for the replacement of one of the batteries without losing power and thus not losing the data stored in the memory. (**Warning: Please do not take out these two batteries at the same time or the data will be lost during this period of non-power.**)

- **Use “R_MB_ADR” function to Detect the Status of Dual Battery**

Use the Function “R_MB_ADR” and assign its parameter “ADR” as “9992” and “9993” to read the batteries’ status. Show as the 1st and 2nd line of the LD program listed as below.

ADR number “9992” : the status of battery number 1.

ADR number “9993” : the status of battery number 2.

- **Use “R_MB_ADR” function to Detect the Status of Ethernet port**

Use the Function “R_MB_ADR” and assign its parameter “ADR” as “9987” to read the status of the Ethernet ports. Show as the 3rd line of the LD program listed as below.

ADR number “9987” : the status of LAN1.

Name	Type	Attrib.	ADR	Description
battery1	Integer	Internal	9992	Detect the status of battery 1.
battery2	Integer	Internal	9993	Detect the status of battery 2.
lan1	Binary	Internal	9987	Detect the status of LAN1.

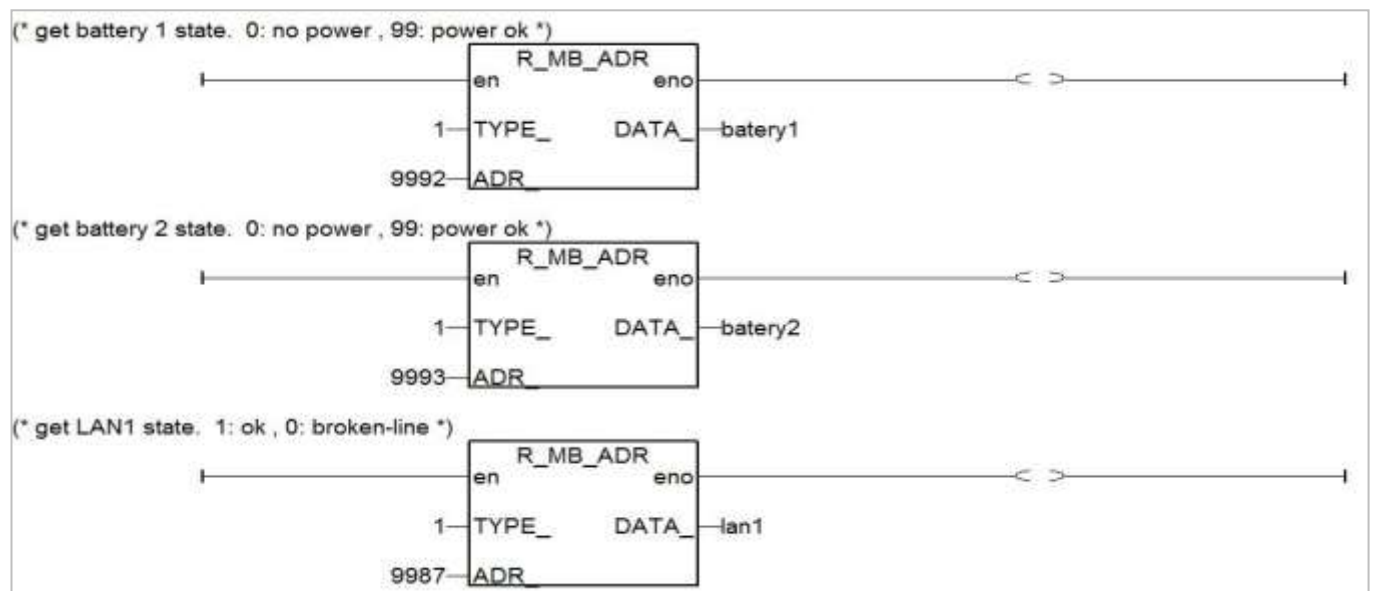

After executing the program:

1. The return values for parameters “battery1” & “battery2” status:
 - "99" : Power ok, no require to replace the battery at the moment.
 - "0" : Low power status; please replace the battery as soon as possible.
2. The return values for parameters “lan1” status:
 - "1" : ok.
 - "0" : broken-line.