

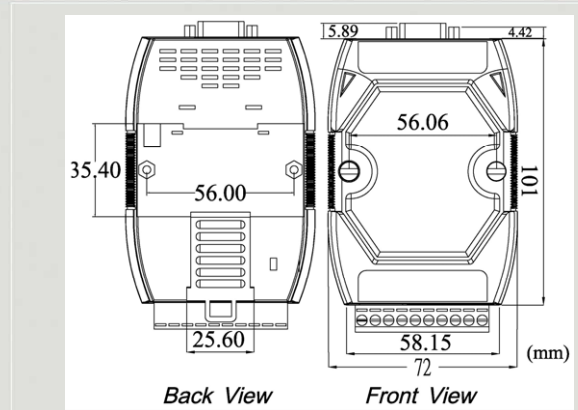

## Intelligent Modbus RTU to CAN Converter



I-7530A-MR



Dimensions

The I-7530A-MR is designed to unleash the power of CAN bus via RS-232/485/422 communication method. It accurately converts messages between CAN and RS-232/485/422 networks. This module let you communicate with CAN devices easily from any PC or devices with RS-232/485/422 interface. The programmable RS-232/485/422 device (For example: PC, PLC or PAC) or Modbus RTU master device can use the serial port to connect to the CAN network via the I-7530A-MR.

## Features

- RoHS Design
- Fully compatible with ISO 11898-2 standard
- Programmable CAN bus baud rate from 10 kbps to 1Mbps or user-defined baud rate
- Support CAN bus acceptance filter configuration
- Support firmware update via RS-232
- Provide utility tool for users module setting and CAN bus communication testing conveniently
- Built-in jumper to select 120Ω terminal resistor
- Provide 128 data frames in the CAN buffer and 256 bytes in the UART buffer
- Power, data flow and error indicator for CAN and UART
- Hardware Watchdog design
- Convert CAN message to specific ASCII command string (Normal mode)
- Convert specific ASCII command string to CAN message (Normal mode)
- Provide the transparent communication between the RS-232/485/422 devices via CAN bus (Pair-connection mode)
- Support function code 0x03/0x04/0x10 of Modbus RTU functions for reading and writing CAN message (Modbus RTU mode)

## Utility Features

- CAN bus baud rate configuration
- CAN acceptance filter configuration
- RS-232/485/422 baud rate and data format configuration
- RS-232/485/422 communication with checksum function selection
- Communication mode setting
- Easily transmit/receive CAN messages

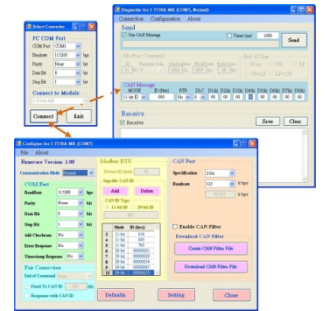

## CAN Monitor &amp; Data log Tools

- Show CAN messages in hex or decimal format
- CAN messages with timestamp
- Easy-to-use data logger for the diagnosis of the CAN networks and recording of the received data
- Send the predefined CAN messages manually or cyclically

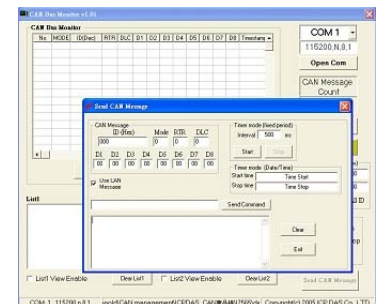

## Hardware Specifications

CAN Interface	
Controller	Microprocessor inside with 96 MHz
Transceiver	NXP 82C250
Connector	9-pin male D-Sub (CAN L, CAN H, N/A for others)
Channels	1
Baud Rate(bps)	10 k, 20 k, 50 k, 100 k, 125 k, 250 k, 500 k, 800 k and 1 M (allow user-defined baud rate)
Protection	3000V <sub>DC</sub> power protection and 3750V <sub>rms</sub> photo-couple isolation on CAN side
Terminal Resistor	Selectable 120Ω terminal resistor by jumper
Support Protocol	ISO-11898-2, CAN 2.0A and CAN 2.0B
Pin Assignment	C.I.A. DS-102 (CAN H=7, CAN L=2)
UART Interface	
Connector	14-pin terminal connector
COM	RS-232: TxD, RxD, GND; RS-422: TxD+, TxD-, RxD+, RxD-; RS-485: DATA+, DATA-
Baud rate(bps)	300, 600, 1200, 2400, 4800, 9600, 19200, 38400, 57600, 115200, 230400
Protection	3000V <sub>DC</sub> power protection and 2500V <sub>rms</sub> photo-couple isolation on UART side
LED	
Round LED	PWR / CAN / UART
Power	
Power supply	+10 ~ +30 V <sub>DC</sub>
Power Consumption	1.5W
Dip Switch	Init (Firmware Update, Module Configuration)/Normal (Firmware Operation)
Mechanism	
Installation	DIN-Rail
Dimensions	72mm x 118mm x 35mm (W x L x H)
Environment	
Operating Temp.	-25°C to 75°C
Storage Temp.	-30°C to 80°C
Humidity	10~90% non-condensing

## Block Diagram

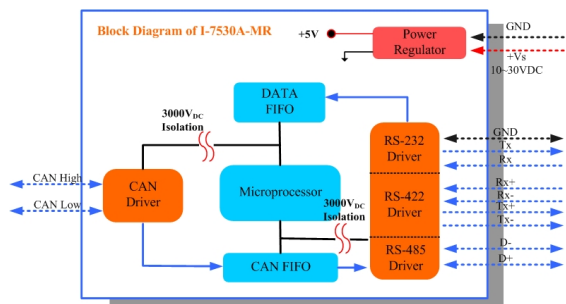

## Pin Assignments

### Pin Assignment

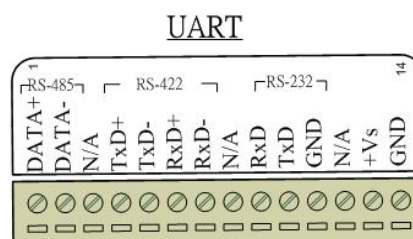

## Application

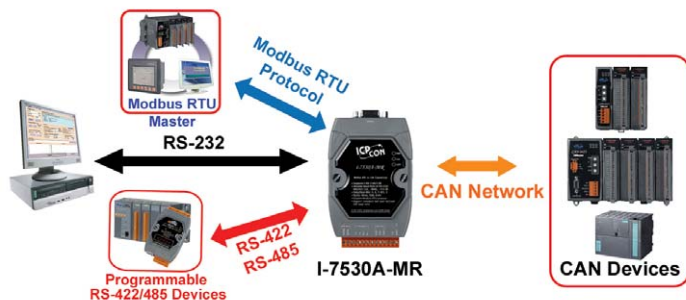

### CAN Bus

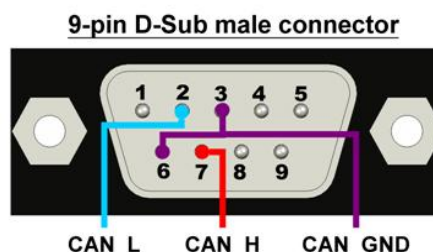

## Ordering Information

**I-7530A-MR-G CR** Intelligent Modbus RTU to CAN converter (RoHS)