







8-ch Isolated (Wet, AC/DC) DI Module

Features

- Supports AC/DC Digital Input
- 8 Differential Digital Inputs
- High Over-voltage Input Protection
- All Channels Can be Used as 16-bit Counters
- Channel-to-Channel Isolation
- Built-in Dual Watchdog

Introduction

The I-7058/I-7059 module offers 8 differential channels for AC/DC Digital Input, each of which features channel-to-channel Photocouplerisolation. All DI channels are also able to be used as 16-bit counters. The I-7058D/I-7059D module has 8 LED indicators fthat can be used to monitor the status of the DI channels. ESD protection of ± 4 kV and 3750 VDC intra-module isolation are standard. M-7058D/M-7059D module has the same hardware specifications as the I-7058/I-7059 module, but provides additional support for the Modbus RTU protocol as well as the DCON protocol.

System Specifications

Model	I-7058	I-7059	I-7058D	I-7059D
	M-7058	M-7059	M-7058D	M-7059D
CPU Module				
Watchdog Timer	Module, Communication (Programmable)			
Display				
Type	-		I/O LED Indicator	
Isolation				
Intra-module Isolation	3750 VDC			
EMS Protection				
EFT (IEC 61000-4-4)	± 4 kV for Power Line			
ESD (IEC 61000-4-2)	± 4 kV Contact for Each Terminal ± 8 kV Air for Random Point			
LED Indicators				
Status	1 x Power and Communication		-	
	-		8 x DI	
COM Ports				
Ports	1 x RS-485			
Baud Rate	1200 ~ 115200 bps			
Data Format	(N, 8, 1), (N, 8, 2), (E, 8, 1), (O, 8, 1)			
Protocol	I-7000: DCON M-7000: Modbus RTU, DCON			
Power				
Reverse Polarity Protection	Yes			
Input Range	+10 ~ +30 VDC			
Consumption	0.3 W	1.0 W		
Mechanical				
Dimensions (mm)	72 x 123 x 35 (W x L x H)			
Installation	DIN-Rail Mounting			

Applications

- Building Automation
- Factory Automation
- Machine Automation
- Remote Maintenance
- Remote Diagnosis
- Testing Equipment

I/O Specifications

Model	I-7058(D) M-7058(D)	I-7059(D) M-7059(D)
Digital Input/Counter		
Channels	8	
Type	Wet Contact	
Sink/Source (NPN/PNP)	Sink/Source	
ON Voltage Level	80 ~ 250 VAC ± 80 ~ ± 250 VDC	10 ~ 80 VAC ± 15 ~ ± 80 VDC
OFF Voltage Level	30 VAC Max. ± 30 VDC Max.	3 VAC Max. ± 3 VDC Max.
Max. Counts	65535 (16-bit)	
Min. Pulse Width	5 ms	
Frequency	100 Hz	
Input Impedance	68 k Ω	10 k Ω
Overvoltage Protection	300 VAC/VDC Max.	100 VAC/VDC Max.
Channel-to-Channel Isolation	± 2 kV	

Mechanical	
Dimensions (mm)	72 x 123 x 35 (W x L x H)
Installation	DIN-Rail Mounting
Environment	
Operating Temperature	-25 ~ +75°C
Storage Temperature	-40 ~ +85°C
Humidity	10 ~ 95% RH, Non-condensing

Internal I/O Structure

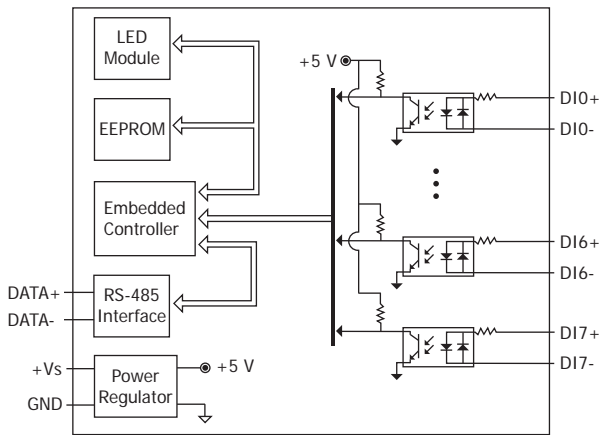

Pin Assignments

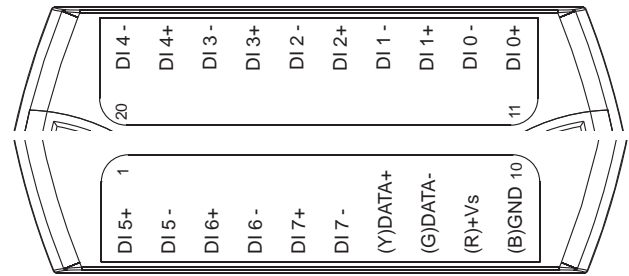

Wire Connections

Digital Input/Counter	ON State Readback as 1				OFF State Readback as 0			
	I-7058 M-7058	I-7058D M-7058D	I-7059 M-7059	I-7059D M-7059D	I-7058 M-7058	I-7058D M-7058D	I-7059 M-7059	I-7059D M-7059D
AC Digital Input	80 ~ 250 VAC		10 ~ 80 VAC		OPEN or < 30 VAC Max.		OPEN or < 3 VAC Max.	
DC Digital Input	80 ~ 250 VDC		15 ~ 80 VDC		OPEN or < 30 VDC Max.		OPEN or < 3 VDC Max.	

Ordering Information

I-7058 CR		using DCON Protocol (Blue Cover) (RoHS)	I-7058D CR	I-7058 with LED Display (Blue Cover) (RoHS)
I-7058-G CR	8-ch Isolated (Wet, 80~250 VAC/ ±100~±250 VDC) DI Module	using DCON Protocol (Gray Cover) (RoHS)	I-7058D-G CR	I-7058-G with LED Display (Gray Cover) (RoHS)
M-7058-G CR		using DCON and Modbus Protocols (Gray Cover) (RoHS)	M-7058D-G CR	M-7058-G with LED Display (Gray Cover) (RoHS)
I-7059 CR	8-ch Isolated (Wet, 10~80 VAC/ ±15~±80 VDC) DI Module	using DCON Protocol (Blue Cover) (RoHS)	I-7059D CR	I-7059 with LED Display (Blue Cover) (RoHS)
I-7059-G CR		using DCON Protocol (Gray Cover) (RoHS)	I-7059D-G CR	I-7059-G with LED Display (Gray Cover) (RoHS)
M-7059-G CR		using DCON and Modbus Protocols (Gray Cover) (RoHS)	M-7059D-G CR	M-7059-G with LED Display (Gray Cover) (RoHS)

Accessories

tM-7520U CR		Tiny Isolated RS-232 to RS-485 Converter (RoHS)	I-7514U-G CR		Isolated 4-channel RS-485 Repeater/Hub/Splitter (Gray Cover) (RoHS)
tM-7561 CR		Tiny USB to Isolated RS-485 Converter with CA-USB18 Cable (RoHS)	SG-770 CR		7/14 channel Surge Protector (RoHS)
tM-SG4 CR		RS-485 Pull-high/Pull-low and Termination Resistor Module (RoHS)	SG-3000 Series		Signal Conditioning Modules for Thermocouple, RTD, DC Voltage, DC Current and Power Input Transformers