



I-7018Z

M-7018Z

10-ch Thermocouple Input Module

Features

- 10 Analog Inputs
- Provides Stable and Consistent Temperature Output
- Current, Voltage, and Thermocouple Inputs
- High Over-voltage Input Protection
- High Common Voltage Protection
- Individual Channel Configuration
- Open Thermocouple Detection
- Built-in Dual Watchdog



Introduction

The I-7018Z/M-7018Z is a 10-channel Analog Input module that measures thermocouples, voltage, and current inputs. It has an RS-485 interface and features automatic cold-junction compensation for each channel to ensure temperature output consistency and stable temperature output in the field. The enhanced design improves thermocouple measurement accuracy. The module provides overvoltage protection of up to 240 Vrms and per-channel open wire detection for the thermocouple and +4 ~ +20 mA input channels. The M-7018Z also supports both Modbus RTU and DCON protocols, while the hardware specifications are the same as the I-7018Z.

Applications

- Building Automation
- Machine Automation
- Remote Diagnosis
- Factory Automation
- Remote Maintenance
- Testing Equipment

System Specifications

Model	I-7018Z	M-7018Z
CPU Module		
Watchdog Timer	Module, Communication (Programmable)	
Isolation		
Intra-module Isolation	3000 VDC	
EMS Protection		
EFT (IEC 61000-4-4)	±4 kV for Power Line	
ESD (IEC 61000-4-2)	±4 kV Contact for Each Terminal	
Surge (IEC 61000-4-5)	±0.5 kV for Power Line	
LED Indicators		
Status	1 x Power and Communication	
COM Ports		
Ports	1 x RS-485	
Baud Rate	1200 ~ 115200 bps	
Data Format	(N, 8, 1), (N, 8, 2), (E, 8, 1), (O, 8, 1)	
Protocol	I-7000: DCON M-7000: Modbus RTU, DCON	
Power		
Reverse Polarity Protection	Yes	
Input Range	+10 ~ +30 VDC	
Consumption	1.0 W	
Mechanical		
Dimensions (mm)	I-7018Z	73 x 116 x 35 (W x L x H)
	DB-1820	65 x 78 x 22 (W x L x D)
	DN-1822	103 x 96 x 27 (W x L x D)
	DN-1823	103 x 100 x 27 (W x L x D)
Installation	DIN-Rail Mounting	

I/O Specifications

Model	I-7018Z	M-7018Z
Analog Input		
Channels	10 Differential	
Type	Voltage, Current, Thermocouple	
Sensor Types	Thermocouple	J, K, T, E, R, S, B, N, C, L, M, LDIN43710
Range	Voltage	±15 mV, ±50 mV, ±100 mV, ±500 mV, ±1 V, ±2.5 V
	Current	±20 mA, 0 ~ 20 mA, 4 ~ 20 mA (requires an optional external 125 Ω resistor)
Resolution	16-bit	
Accuracy	0.1% of FSR	
Sampling Rate	10 Hz (Total)	
Input Impedance	> 400 kΩ	
Common Voltage Protection	±200 VDC	
Overvoltage Protection	240 Vrms	
Individual Channel Configuration	Yes	
Open Wire Detection	For Thermocouple (*Note1) and 4 ~ 20 mA	

Note1:
This feature is software selectable and requires firmware version B4.4 or later.

Environment	
Operating Temperature	-25 ~ +75 °C
Storage Temperature	-40 ~ +85 °C
Humidity	10 ~ 95% RH, Non-condensing

Thermocouple Types

Type Code	Thermocouple Type	Temperature Range
0E	Type J	-210 to +760°C
0F	Type K	-270 to +1372°C
10	Type T	-270 to +400°C
11	Type E	-270 to +1000°C
12	Type R	0 to +1768°C
13	Type S	0 to +1768°C
14	Type B	0 to +1820°C
15	Type N	-270 to +1300°C
16	Type C	0 to +2320°C
17	Type L	-200 to +800°C
18	Type M	-200 to +100°C
19	Type LDIN43710	-200 to +900°C

Internal I/O Structure

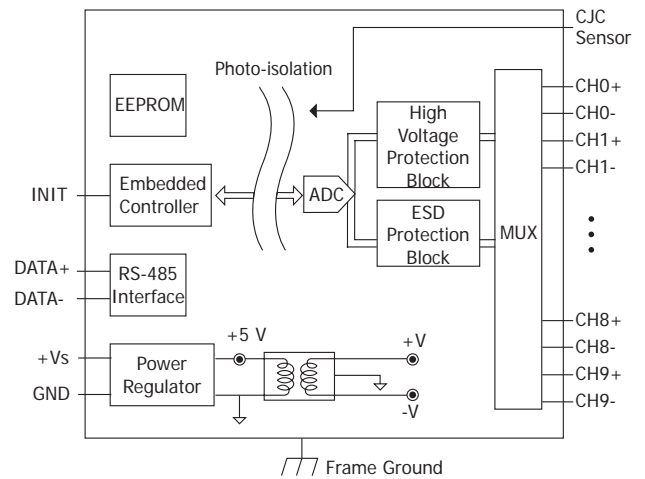

Pin Assignments

I-7018Z/M-7018Z

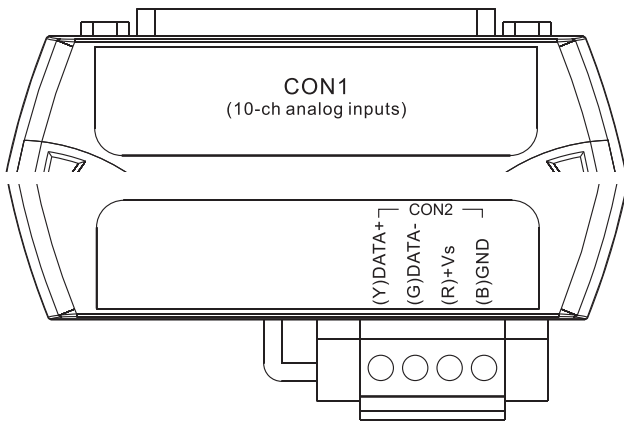

CON1			
Pin Assignment	Terminal	No.	Pin Assignment
+5V	01	14	AGND
CJC	02	15	CH 0+
CH 0 -	03	16	CH 1+
CH 1 -	04	17	CH 2+
CH 2 -	05	18	CH 3+
CH 3 -	06	19	CH 4+
CH 4 -	07	20	CH 5+
CH 5 -	08	21	CH 6+
CH 6 -	09	22	CH 7+
CH 7 -	10	23	CH 8+
CH 8 -	11	24	CH 9+
CH 9 -	12	25	N.C.
N.C.	13	Shield	F.G.

25-pin Female D-Sub Connector

DB-1820

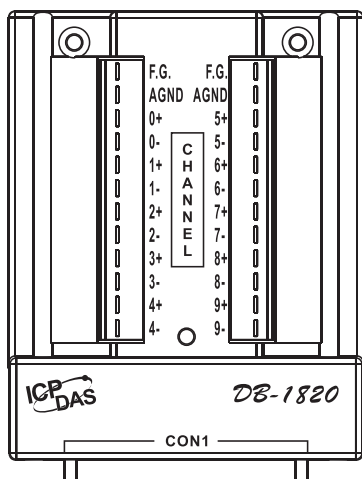

DN-1822

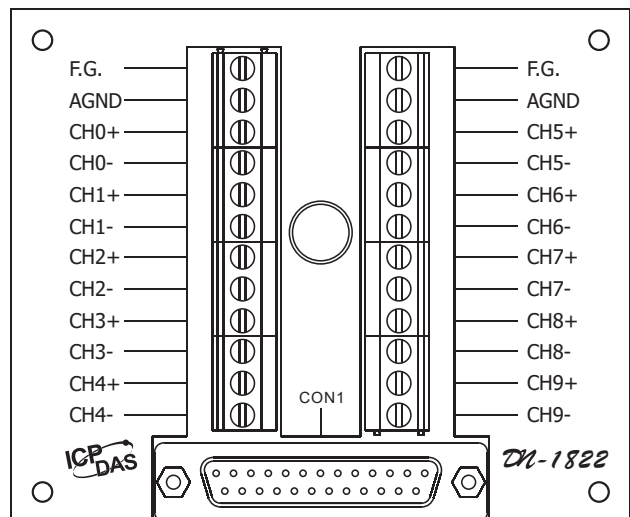

DN-1823

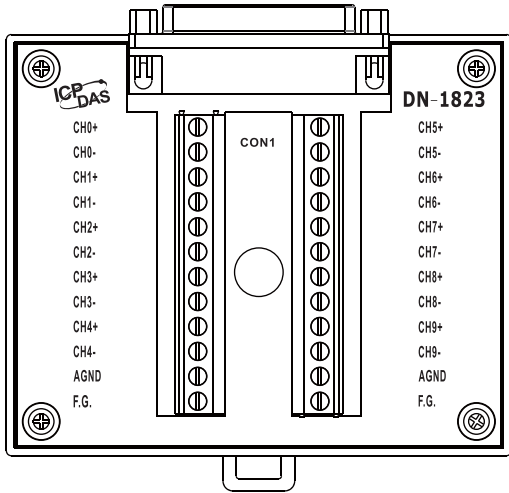

Wire Connections

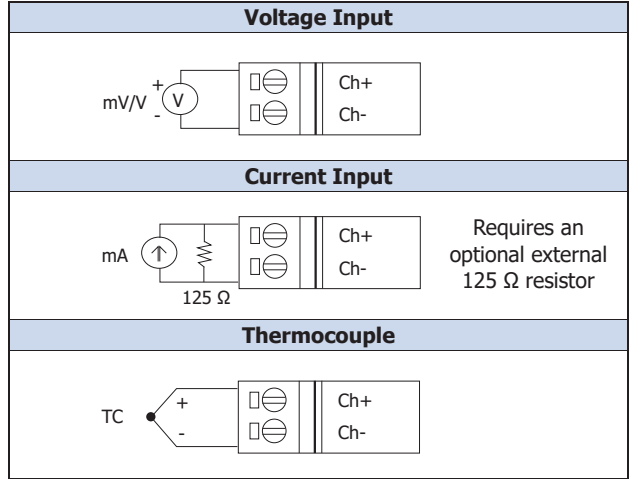

Dimensions (Units: mm)

I-7018Z/M-7018Z

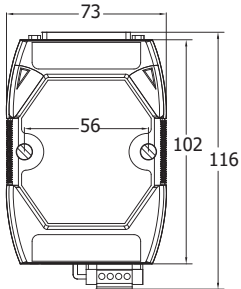

Front View

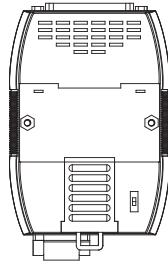

Rear View

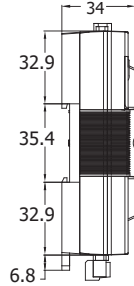

Left Side View

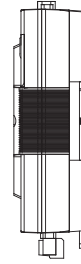

Right Side View

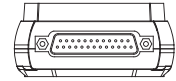

Top View

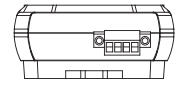

Bottom View

DB-1820

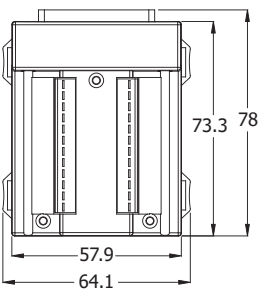

Front View

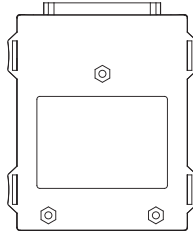

Rear View

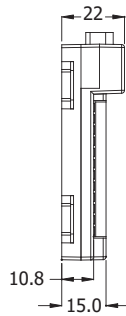

Left Side View

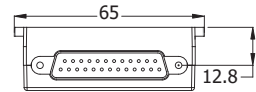

Top View

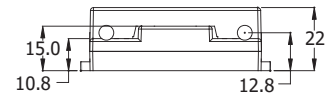

Bottom View

DN-1822

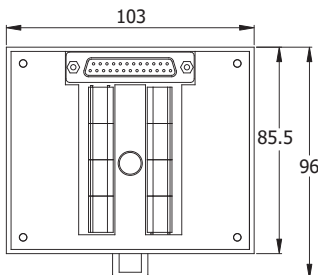

Front View

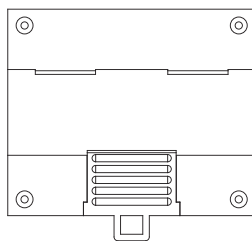

Rear View

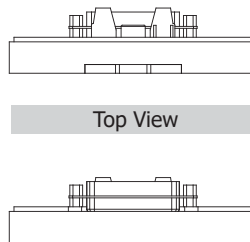

Bottom View



Left Side View

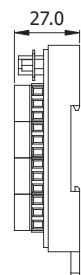

Right Side View

DN-1823

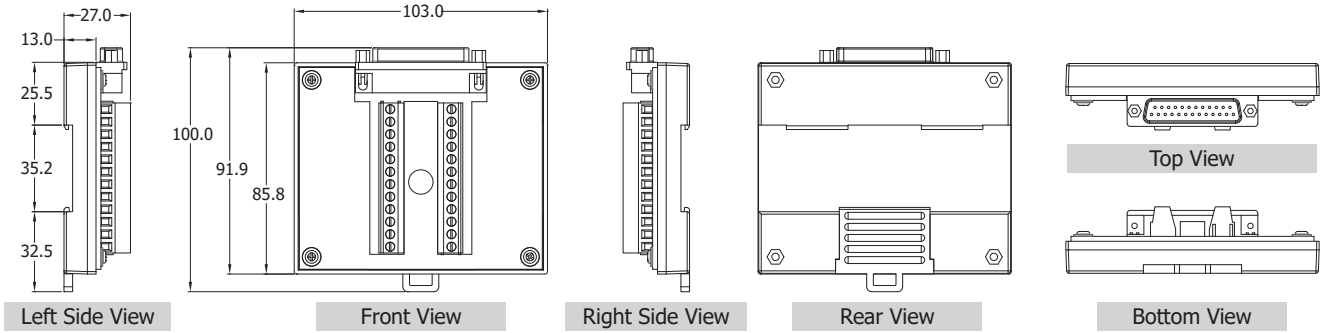

Ordering Information

I-7018Z-G/S CR	10-ch Thermocouple Input Module using DCON Protocol (Gray Cover) (RoHS) Includes DB-1820 Daughter Board and Plastic DIN Rail (4PAPP-006-G)
I-7018Z-G/S2 CR	10-ch Thermocouple Input Module using DCON Protocol (Gray Cover) (RoHS) Includes DN-1822 Daughter Board, CA-252518D-1 1.8 m Cable and Plastic DIN Rail (4PAPP-006-G)
I-7018Z-G/S3 CR	10-ch Thermocouple Input Module using DCON Protocol (Gray Cover) (RoHS) Includes DN-1823 Daughter Board, CA-2525015D 15 cm Cable and Plastic DIN Rail (4PAPP-006-G)
M-7018Z-G/S CR	10-ch Thermocouple Input Module using DCON and Modbus Protocols (Gray Cover) (RoHS) Includes DB-1820 Daughter Board and Plastic DIN Rail (4PAPP-006-G)
M-7018Z-G/S2 CR	10-ch Thermocouple Input Module using DCON and Modbus Protocols (Gray Cover) (RoHS) Includes DN-1822 Daughter Board, CA-252518D-1 1.8 m Cable and Plastic DIN Rail (4PAPP-006-G)
M-7018Z-G/S3 CR	10-ch Thermocouple Input Module using the DCON and Modbus Protocols (Gray Cover) (RoHS) Includes DN-1823 Daughter Board, CA-2525015D 15 cm Cable and Plastic DIN Rail (4PAPP-006-G)

<p>Front</p> <p>I-7018Z-G/S = DB-1820 Connects to the I-7018Z Directly M-7018Z-G/S = DB-1820 Connects to the M-7018Z Directly</p>	<p>Rear</p> <p>I-7018Z-G/S2 = DN-1822 Connects to the I-7018Z Directly M-7018Z-G/S2 = DN-1822 Connects to the M-7018Z Directly</p>	<p>I-7018Z-G/S3 = DN-1823 Connects to the I-7018Z Directly M-7018Z-G/S3 = DN-1823 Connects to the M-7018Z Directly</p>
--	---	--

Accessories

2AB125R		DIP Resistor, 125 ohm, 0.1%, 1/4W, MF, 50 ppm/°C (1PCS) (RoHS)
CD-2518D CR		DB25 Male to Female 1.8 m Cable (180°) and DIN-Rail Mounting Mount for the DB-1820 (RoHS)
CD-25015 CR		DB25 Male to Female 15 cm Cable (90°) and DIN-Rail Mounting Mount for the DB-1820 (RoHS)

<p>I-7018Z-G/S + CD-25015 + 4PAPP-006-G M-7018Z-G/S + CD-25015 + 4PAPP-006-G</p>	<p>CD-25015 4PAPP-006-G</p>	<p>I-7018Z-G/S + CD-2518D M-7018Z-G/S + CD-2518D</p>
--	---	--