

ZT-2005-C8

User Manual

Warranty

All products manufactured by ICP DAS are under warranty regarding defective materials for a period of one year, beginning from the date of delivery to the original purchaser.

Warning

ICP DAS assumes no liability for any damage resulting from the use of this product. ICP DAS reserves the right to change this manual at any time without notice. The information furnished by ICP DAS is believed to be accurate and reliable. However, no responsibility is assumed by ICP DAS for its use, nor for any infringements of patents or other rights of third parties resulting from its use.

Copyright

Copyright © 2013 by ICP DAS. All rights are reserved.

Trademarks

Names are used for identification purposes only and may be registered trademarks of their respective companies.

Technical Support

If you have any problems, please feel free to contact us via email at service@icpdas.com.

Table of Contents

1	Introduction	5
1.1	Introduction to ZigBee	5
1.2	Introduction to the ZT-2005-C8	6
2	Hardware Information	7
2.1	Specifications	7
	Specifcaions of ZigBee	7
	Specifcaions of ZT-2005-C8 module	7
2.2	Pin assignments	9
	ZT-2005-C8	9
3	Setting up the ZT-2005-C8	10
3.1	Introction to the Configuration Parameters	10
3.2	Introduction to the Rotary and DIP Switches	11
3.3	Starting the ZT-2005-C8	13
3.4	Examples	14
3.5	Communications Testing	15
4	Format, Type and Calibration	16
4.1	Over/Under Range Readings	16
4.2	Configuration Tables	16
4.3	Type code and Data Format Table	17
4.4	Calibration	17
5	The DCON/Modbus RTU Command Sets	18
5.1	Communication with the ZT-2005-C8 module	18
5.2	The DCON Protocol Command Set	18
5.2.1	Checksum	19
5.2.2	Overview of the DCON Command Set	20
5.2.3	%AANNTTCCFF	21
5.2.4	#AA	22
5.2.5	#AAN	23
5.2.6	\$AA0Ci	24
5.2.7	\$AA1Ci	25
5.2.8	\$AA0	26
5.2.9	\$AA1	27

5.2.10	\$AA2.....	28
5.2.11	\$AA5VV.....	29
5.2.12	\$AA6.....	30
5.2.13	\$AAF.....	31
5.2.14	\$AAM.....	32
5.2.15	\$AAP.....	33
5.2.16	\$AAS1.....	34
5.2.17	~AAD.....	35
5.2.18	~AADT.....	36
5.2.19	~AAEV.....	37
5.2.20	~AARE.....	38
5.2.21	@AAA2CiToo.....	39
5.2.22	@AAA3Ci.....	40
5.3	<i>Modbus RTU Protocol</i>	41
5.3.1	Modbus Address Mapping.....	42
5.3.2	Function 01(0x01)-Read Coils.....	43
5.3.3	Function 02(0x02)-Read Discrete Inputs.....	44
5.3.4	Function 03(0x03)-Read Multiple Registers.....	45
5.3.5	Function 04(0x04)-Read Multiple Input Registers.....	46
5.3.6	Fuction 05(0x05)-Write Single Coil.....	47
5.3.7	Function 06(0x06)-Write Single Register.....	48
5.3.8	Function 15(0x0F)-Write Multiple Coils.....	49
5.3.9	Function 16(0x10)-Write Multiple Registers.....	50
5.3.10	Function 70(0x46)-Read/Write Module Setting.....	51
5.3.10.1	Sub-function 00(0x00)-Read Module Name.....	52
5.3.10.2	Sub-function 04(0x04)-Write Module Address.....	53
5.3.10.3	Sub-function 05(0x05)-Read the communication setting.....	54
5.3.10.4	Sub-function 32(0x20)-Read Module Firmware Version.....	55
5.3.10.5	Sub-function 37(0x25)-Read The Enabled/Disable status of Channels.....	56
5.3.10.6	Sub-function 38(0x26)-Write The Enabled/Disable status of Channels.....	57
6	Troubleshooting	58
7	Appendix	59
7.1	<i>LED Display Status</i>	59
7.2	<i>The Extension to the Software Address</i>	59

What's in the Shipping Package?

The shipping package contains the following items:



ZT-2005-C8
module



Antenna
(ANT-124-05)



Quick Start



Thermistor
(CA-021)



CD

If any of these items are missing or damaged, please contact your local distributor for more information. Save the shipping materials and cartons in case you want to ship the module in the future.

More Information

■ Documentation :

CD: \Napdos\ZigBee\ZT_Series\Document

http://ftp.icpdas.com/pub/cd/usbcd/napdos/zigbee/zt_series/document

■ Software :

CD: \Napdos\ZigBee\ZT_Series\Utility

http://ftp.icpdas.com/pub/cd/usbcd/napdos/zigbee/zt_series/utility

1 *Inftrouduction*

1.1 Introduction to ZigBee

ZigBee is a specification for a suite of high-level communication protocols using small, low-power digital radios based on the IEEE 802.15.4 standard for personal area networks. ZigBee devices are often used in mesh network form to transmit data over longer distances, passing data through intermediate devices to reach more distant ones. This allows ZigBee networks to be formed ad-hoc, with no centralized control or high-power transmitter/receiver able to reach all of the devices. Any ZigBee device can be tasked with running the network.

ZigBee is targeted at applications that require a low data rate, long battery life, and secure networking. ZigBee has a defined rate of 250 kbit/s, best suited for periodic or intermittent data or a single signal transmission from a sensor or input device. Applications include wireless light switches, electrical meters with in-home-displays, traffic management systems, and other consumer and industrial equipment that requires short-range wireless transfer of data at relatively low rates. The technology defined by the ZigBee specification is intended to be simpler and less expensive than other WPANs.

1.2 Introduction to the ZT-2005-C8

The ZT-2005-C8 is an 8 channel thermistor input module, it can monitor the resistance change of thermistor to get temperature.

The ZT-2005-C8 is a wireless ZigBee module, it need to communicate with ZigBee coordinator. The information of ZigBee coordinator can refer ZT-2550 or ZT-2570. Otherwise, users can use rotary switch and DIP switch to set address (or ZigBee Node ID, NID) of module, protocol, DCON checksum, ZigBee RF Power, ZigBee Pan ID (PID), and ZigBee channel.

2 *Hardware Information*

2.1 Specifications

➤ Specifications of ZigBee

Wireless	
RF Channels	16
RF Transmit Power	11 dBm
Antenna (2.4 GHz)	5 dBi Omni-directional antenna
Transmit Range (LOS)	700 m (Typical)
Max. Slaves Supported	255
EMI Certification	FCC ID

➤ Specifications of ZT-2005-C8 module

Gernal		
LED Indicator	PWR	1 Red LED, ZigBee Device Power Indicator
	ZBRx	1 Yellow LED, The status of ZigBee communication
	ZBNET	1 Green LED, The status of ZigBee network.
Protocols	Supports DCON and Modbus RTU Protocols	
Hot Swap	Rotary and DIP switch	
EMS Protection		
ESD (IEC 61000-4-2)	±2 kV Contact for each Terminal	
EFT (IEC 61000-4-4)	±1 kV for Power Line	
Surge (IEC 61000-4-5)	±1 kV for Power Line	
Mechanical		
Flammability	Fire Retardant Materials (UL94-V0 Level)	
Dimensions (W x L x H)	33 mm x 87 mm x 110 mm	
Installation	DIN-Rail	
Environment		
Operating Temperature	-25 ~ 75 °C	
Storage Temperature	-30 ~ 80 °C	
Relative Humidity	10 ~ 90% RH, Non-condensing	
Power		
Input Voltage Range	+10 V _{DC} ~ +30 V _{DC}	
Power consumption	1 W (Max.)	
Intra-module Isolated, Field-to-Logic	1000 V _{DC}	
Analog Input		
Input channels	8	
Input Type	Thermistor (Only CA-021)	
Resolution	12 bits	

Sampling Rate	10 Hz total
Accuracy	±1°C
Thermistor (CA-021)	
Pipe	φ 6x60mm, stainless stell (SUS304)
Wire	4.94m, UL2651 #24AWG*2C (TS)
Connector	2pin, pitch 2.0mm
Resistance	R25=10K(Ω)±1%
B Constant	R25/85=3435(K)±1%
Dissipation Factor	≥3(mW/°C)
Thermal Time Constant	≤ 15 (sec)
Measuring Temperature Range	-40 ~ 105°C

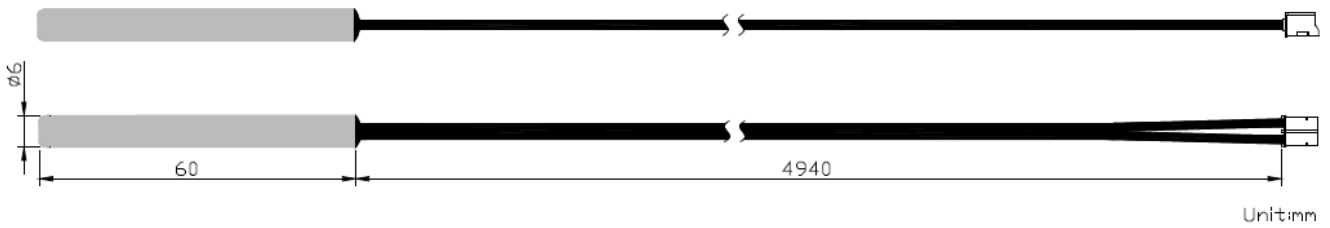

2.2 Pin assignments

➤ ZT-2005-C8

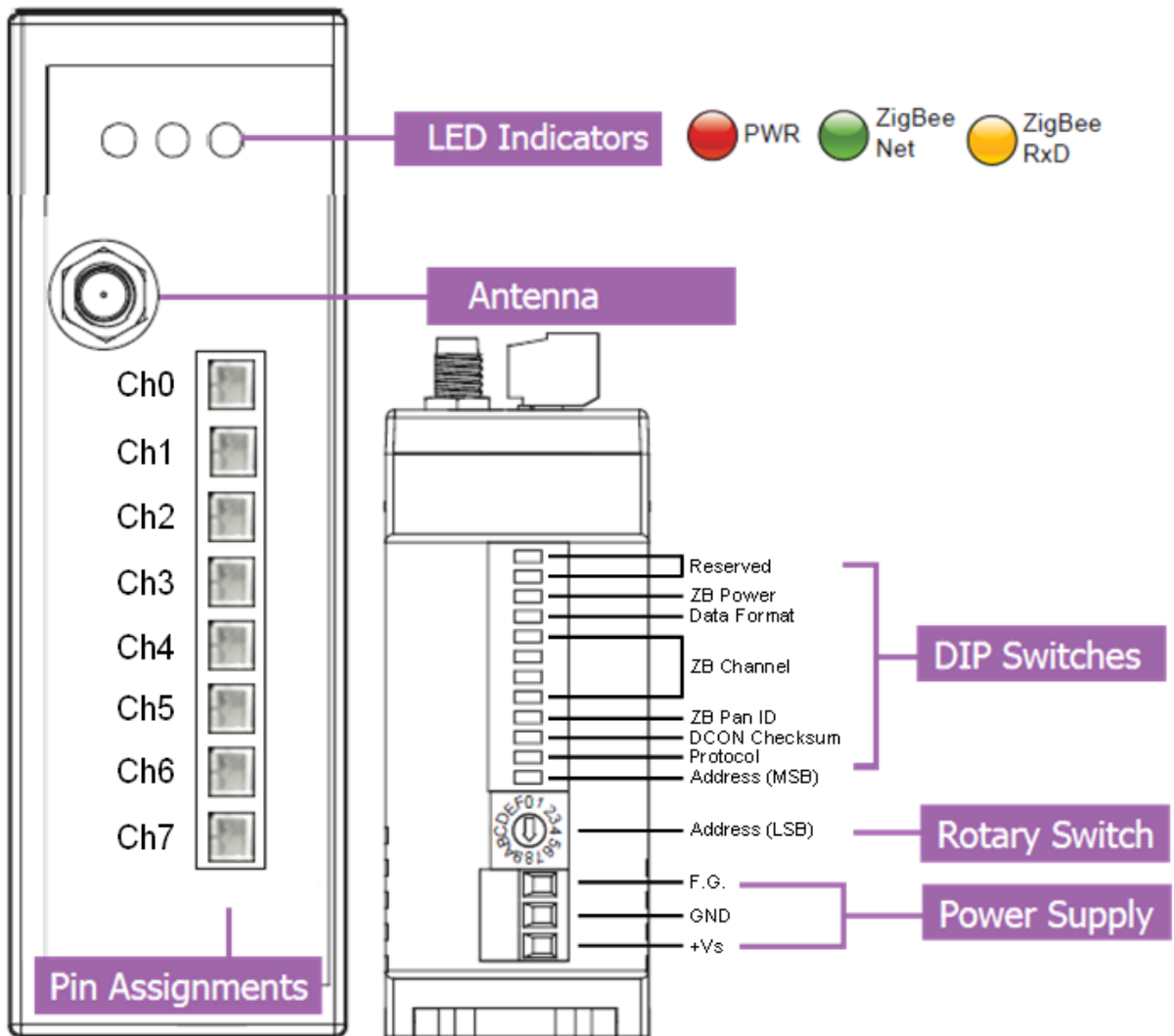

3 *Setting up the ZT-2005-C8*

3.1 Introduction to the Configuration Parameters

- 1. Pan ID** : "Pan ID" parameter is the group identity for a ZigBee network, and must be the same for all devices in the same ZigBee network. (The range are 0 to 1, 0x0000~0x0001)
- 2. Address/Node ID** : "Address/Node ID" parameter is the individual identity of a specific ZigBee module, and must be unique for each device connected to the same ZigBee network. (The range are 1 to 247, 0x0001~0x00F7)
- 3. RF Channel** : "RF Channel" parameter indicates the radio frequency channel, and must be set to the same value as other modules on the same ZigBee network.

RF channel	0x00	0x01	0x0F
Frequency (MHz)	2405	2410	2480

RF channels 0x04, 0x09, 0x0E or 0x0F are recommended because they do not overlap with the Wi-Fi frequency band.

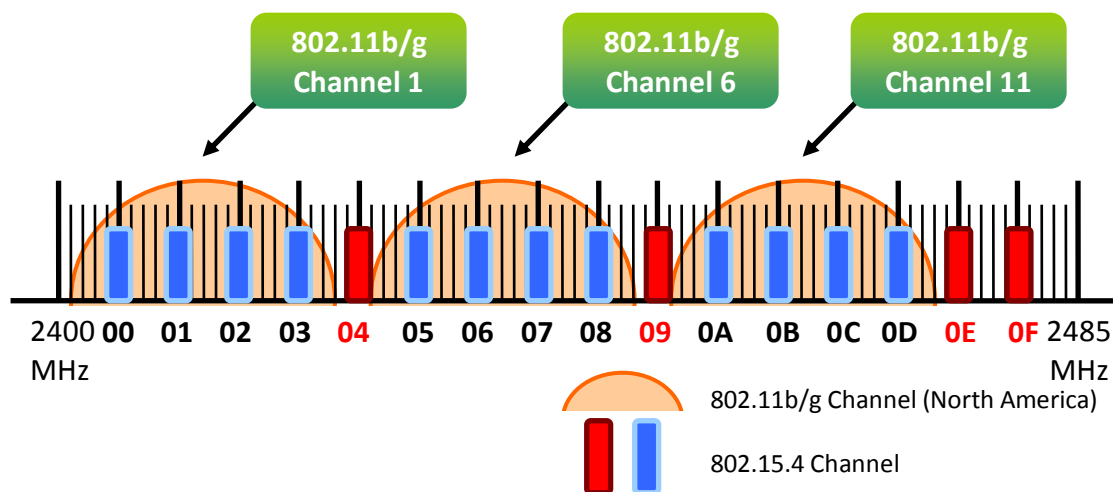

- 4. Protocol/Application Mode** : When implementing custom programs based on different protocols, the following application mode(s) are recommended.

User Program Protocol	ZT-2005-C8	ZT-2550	ZT-2570
DCON	DCON	Transparent	Transparent
Modbus RTU	Modbus RTU	Transparent Modbus Gateway	Transparent Modbus Gateway

3.2 Introduction to the Rotary and DIP Switches

The configuration of the ZT-2005-C8 can be adjusted using a combination of the external rotary switch and the DIP switches. The ZT-2005-C8 device should only be rebooted once the configuration is complete.

➤ DIP and rotary switch of ZT-2005-C8

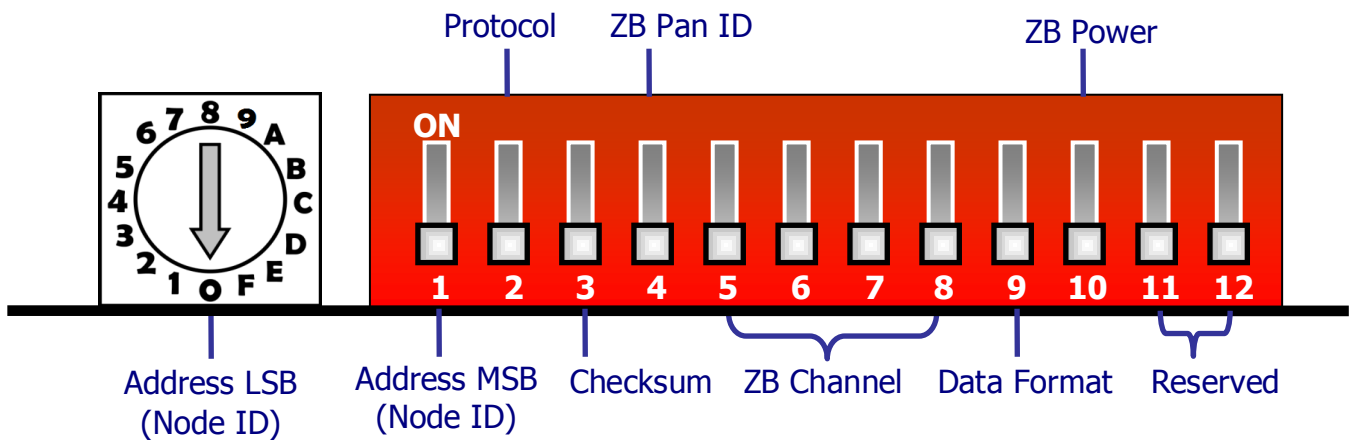

➤ Rotary Switch

	0	1	2	3	F	Note
Address	SW	01	02	03	0F	MSB=0
Node ID	SW	0x0001	0x0002	0x0003	0x000F	
	0	1	2	3	F	
Address	10	11	12	13	1F	MSB=1
Node ID	0x0010	0x0011	0x0012	0x0013	0x001F	

※ Once the address of hardware switch is set to 0x00, it means the address is using software configurations. Refer Sec. 7.2 for more detailed information.

➤ DIP Switch

DIP Switch	Item	Status	Description
1	Address MSB	OFF	Address/Node ID from 0x00 to 0x0F
		ON	Address/Node ID from 0x10 to 0x1F
2	Protocol	OFF	DCON protocol
		ON	Modbus RTU protocol
3	Checksum	OFF	Disabled (DCON protocol)
		ON	Enabled (DCON protocol)
4	ZigBee Pan ID	OFF	Pan ID = 0x0000

		ON	Pan ID = 0x0001
5	ZigBee RF Channel	OFF	-----
		ON	0x08
6		OFF	-----
		ON	0x04
7		OFF	-----
		ON	0x02
8		OFF	-----
		ON	0x01
9	Data Format	OFF	Engineering units
		ON	2's complement hexadecimal
10	ZigBee RF Power	OFF	Default, about 11±1 dBm
		ON	Maximal, about 19 dBm
11	Reserved	-----	-----
12			

3.3 Starting the ZT-2005-C8

As the ZigBee network is controlled by the ZigBee Coordinator, the ZT-2550/ZT-2570 (ZigBee Coordinator) must be configured first. Refer to the documents section below for full details of how to configure these devices.

Once configuration of the ZigBee Coordinator has been completed, set the "ZB PID" and "ZB Channel" values for the ZT-2000 I/O device to the same values as the network, and then reboot the device. The module will automatically start to function on the ZigBee network using the default protocol.

※ Documents :

http://ftp.icpdas.com.tw/pub/cd/usbcd/napdos/zigbee/zt_series/document/zt-255x/
http://ftp.icpdas.com.tw/pub/cd/usbcd/napdos/zigbee/zt_series/document/zt-257x/

※ Configuration Utility (Used to configure ZigBee Coordinator) :

http://ftp.icpdas.com.tw/pub/cd/usbcd/napdos/zigbee/zt_series/utility/

3.4 Examples

➤ Configurations of ZT-2550/ZT-2570

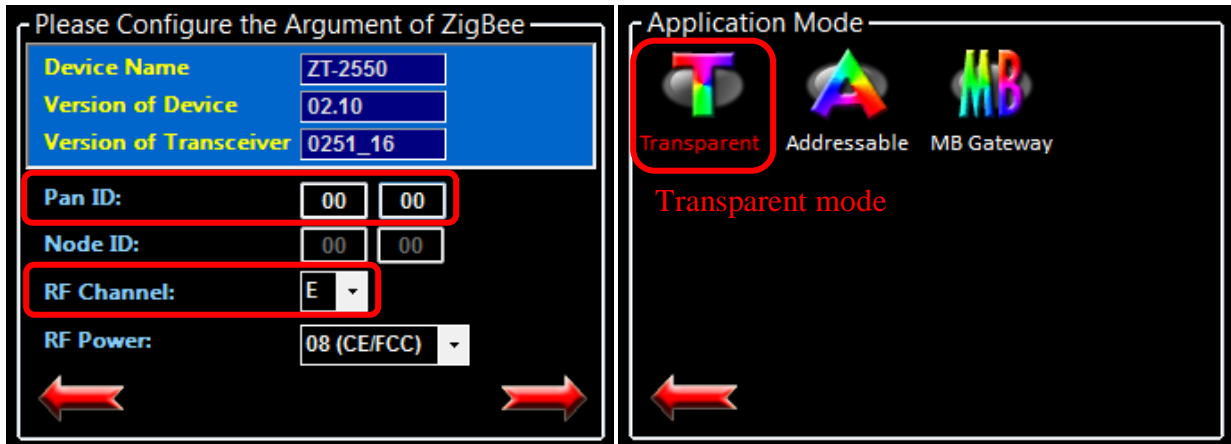

➤ Configuration of ZT-2005-C8

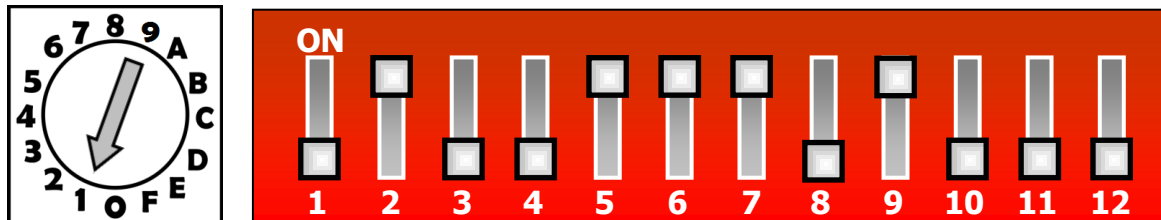

DIP Switch	Item	Status	Description
1	Address MSB	OFF	Address/Node ID is 01 (Rotation Switch = 1)
2	Protocol	ON	Modbus RTU protocol
3	Checksum	OFF	Disabled
4	ZigBee Pan ID	OFF	Pan ID=0x0000
5	ZigBee RF Channel	ON	0x08
6		ON	0x04
7		ON	0x02
8		OFF	0x00
			ZigBee RF Channel=0x0E
9	Data Format	ON	2's complement hexadecimal
10	ZigBee RF Power	ON	Default, about 11±1 dBm
11	Reserved	-----	-----
12		-----	-----

3.5 Communications Testing

Once the ZT-2005-C8 module has joined the ZigBee network, the signal quality can be confirmed by monitoring the status of the ZigBee Net LED indicators. If the LED indicator shows a steady light, communication with the ZT-2005-C8 module has been successfully established for data acquisition and control.

ICP DAS also provides the "DCON Utility", which can be used to simulate DCON/Modbus communication. This software can also be used to verify the device settings and ZT-2005-C8 functions.

- The DCON Utility Pro can be download from:
http://ftp.icpdas.com/pub/cd/8000cd/napdos/driver/dcon_utility/
- Simulating I/O channel via the DCON Utility Pro
 1. Launch the DCON Utility and select the appropriate COM Port settings to connect to the ZigBee Coordinator (ZT-2550/ZT-2570).
 2. Click the "Search" button to start searching for ZT-2005-C8 modules connected to the same ZigBee network.
 3. If any ZT-2005-C8 modules are found, they will be displayed in the device list window. Double-click the list of the module name to start the platform to operate the I/O channels.

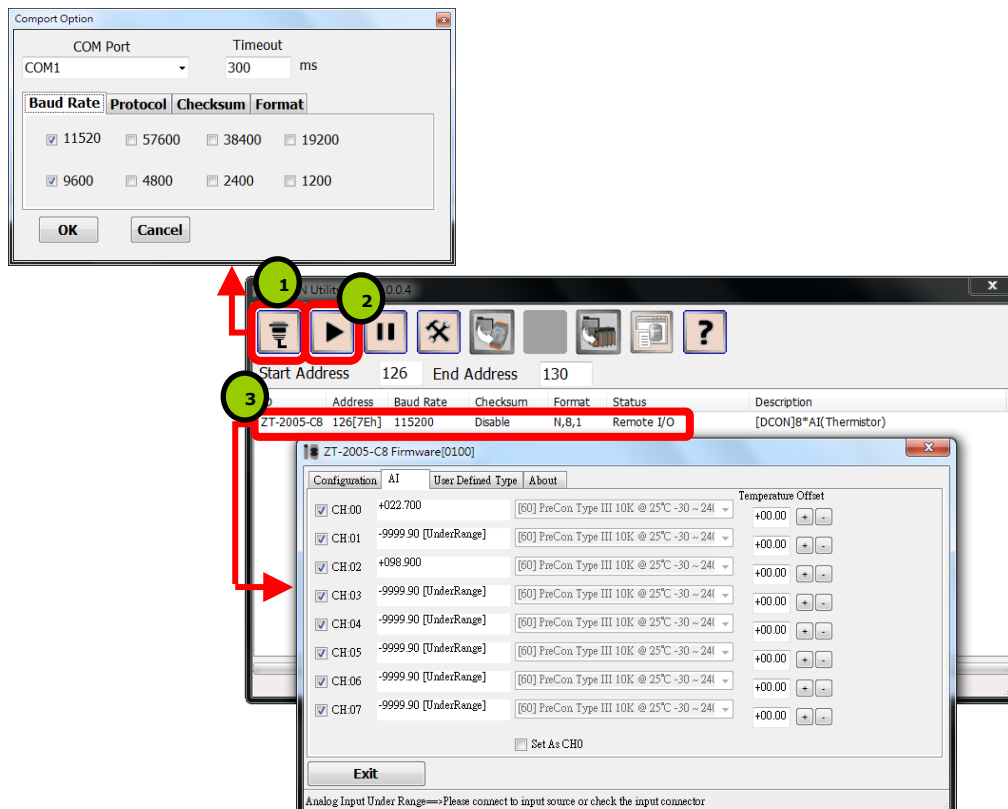

4

Format, Type and Calibration

4.1 Over/Under Range Readings

	Over Range	Under Range
Engineering Units	+9999.9	-9999.9
2' s ComplementHex	7FFF	8000

4.2 Configuration Tables

➤ Baud Rate Setting(CC)

7	6	5	4	3	2	1	0
Data Bit, Parity, Stop Bit		Reserved		Data Rate			

Data Rate (Bit0~Bit3)

Code	3	4	5	6	7	8	9	A
Baud	1200	2400	4800	9600	19200	38400	57600	115200

Data Bit, parity and Stop Bit (Bit6~Bit7)

Code	0	1	2	3
Format	8,n,1	8,n,2	8,e,1	8,o,1

➤ Data Format Setting (FF)

7	6	5	4	3	2	1	0
RS	CS	RS			DF		

Key	Description
RS	Reserved
CS	Checksum setting 0 : Disabled 1 : Enabled
DF	Data format 00 : Engineering unit 01 : Reserved 10 : 2' s complement hexadecimal

4.3 Type code and Data Format Table

Type (Hex)	Thermistor Type	Data Format	+F.S	-F.S
70	User defined	Engineering units	+105.00	-040.00
		2' s comp. Hex	7FFF	CF3C

4.4 Calibration

Warning: Performing calibration is not recommended until the process is fully understood.

The calibration procedure is as follows:

1. Warm up the module for at least 30 minutes.
2. Enable calibration. (Refer to Section 5.2.22.)
3. Connect the zero calibration resistor.
4. Send the zero calibration command. (Refer to Section 5.2.6)
5. Connect the span calibration resistor.
6. Send the span calibration command. (Refer to Section 5.2.7)
7. Repeat steps 2 to 6 three times.

Calibration resistor:

Zero Calibration Resistor	Span Calibration Resistor
150k Ohms	1K Ohms

5 *The DCON/Modbus RTU Command Sets*

5.1 Communication with the ZT-2005-C8 module

ZT-2005-C8 module can be operated using either the DCON or the Modbus RTU protocol, which can be selected by adjusting the position of DIP Switch 2 to OFF (DCON) or ON (Modbus RTU) and then rebooting the ZT-2005-C8 to use the new protocol.

5.2 The DCON Protocol Command Set

The ZT-2005-C8 are controlled via wireless broadcast commands, so each device must have a unique address (or Node ID) that is saved in the EEPROM of the device.

Consequently, all command and response formats contain the address of the destination module. When an I/O device receives a command, it will determine whether or not to respond based on the address contained in the command.

➤ DCON Command Format:

Leading Character	Module Address	Command	[Checksum]	CR
-------------------	----------------	---------	------------	----

➤ DCON Response Format:

Leading Character	Module Address	Data	[Checksum]	CR
-------------------	----------------	------	------------	----

※Note: 'CR' (0x0D) is the end of command (carriage return) character used to end a frame, and all characters should be expressed in capital letters.

5.2.1 Checksum

- Calculation the Checksum:
Sum the ASCII codes of all the characters contained in the command in addition to the 'CR' terminator. The Checksum is the sum value expressed in Hexadecimal format.

 - Example: Command "\$012(CR)"
Sum = '\$' + '0' + '1' + '2' = 24h + 30h + 31h + 32h = B7h
Checksum = "B7"
DCON Command with Checksum = "\$012B7(CR)"

 - Example: Response "!01200600(CR)"
Sum = '!' + '0' + '1' + '2' + '0' + '0' + '6' + '0' + '0'
= 21h+30h+31h+32h+30h+30h+36h+30h+30h
= 1AAh
Checksum = "AA"
DCON Response with Checksum = "!01200600AA(CR)"
- ※Note: The Checksum is the sum value expressed in capital letters.

5.2.2 Overview of the DCON Command Set

General Command Set			
Command	Response	Description	Section
%AANNTTCCFF	!AA	Sets the Configuration of the Module	5.2.3
#AA	>(Data)	Reads the Analog Input Data from all Channels	5.2.4
#AAN	>(Data)	Reads the Analog Input Data from a Specific Channel	5.2.5
\$AA0Ci	!AA	Performs an Analog Input Zero Calibration of a Specific Channel on the Module	5.2.6
\$AA1Ci	!AA	Performs an Analog Input Span Calibration of a Specific Channel on the Module	5.2.7
\$AA0	!AA	Performs an Analog Input Span Calibration on the Module	5.2.8
\$AA1	!AA	Performs an Analog Input Zero Calibration on the Module	5.2.9
\$AA2	!AATTCCFF	Reads the Configuration of the Module	5.2.10
\$AA5VV	!AA	Enables or Disables Specific Analog Input Channels	5.2.11
\$AA6	!AAVV	Reads whether each Analog Input Channel is Enabled or Disabled	5.2.12
\$AAF	!AA(Data)	Reads the Firmware Version of the Module	5.2.13
\$AAM	!AA(Data)	Reads the Name of the Module	5.2.14
\$AAP	!AASC	Reads the communication protocol	5.2.15
\$AAS1	!AA	Reloads the Default Calibration Parameters	5.2.16
~AAD	!AAT	Reads the temperature scaling	5.2.17
~AADT	!AA	Sets the temperature scaling to either °C or °F	5.2.18
~AAEV	!AA	Enables/Disables calibration	5.2.19
~AARE	!AAsc	Read RF Encryption Setting	5.2.20
@AAA2CiToo	!AA	Sets the temperature offset of a channel	5.2.21
@AAA3Ci	!AA	Reads the temperature offset of a channel	5.2.22

5.2.3 %AANNTTCCFF

Description	
This command is used to set the configuration of a specific module.	

Syntax	
%AANNTTCCFF[CHKSUM](CR)	
%	Delimiter character
AA	The address of the module to be configured in hexadecimal format (01 to FF)
NN	The new address of the module in hexadecimal format (01 to FF)
TT	00 (Reserved)
CC	0A (Reserved)
FF	The command used to set the data format and checksum. See Section 4.2 for details of the data format. 00 : Disabled checksum, and use Engineering units. 40 : Enabled checksum, and use Engineering units. 02 : Disabled checksum, and use 2' s Complement Hexadecimal. 42 : Enabled checksum, and use 2' s Complement Hexadecimal.

Response	
Valid Command	!NN[CHECKSUM](CR)
Invalid Command	?AA[CHECKSUM](CR)
!	Delimiter character to indicate a valid command
?	Delimiter character to indicate a invalid command
AA	The address of the responding module in hexadecimal format (01 to FF)
NN	New address of the module in hexadecimal format (01 to FF)
There will be no response if the command syntax is incorrect, there is a communication error, or there is no module with the specified address.	

Examples	
Command	%0101000A00
Response	!01
Setting the address 01 to 01, disable checksum and use engineering units.	

Examples	
Command	%1B01000A42
Response	!01
Setting the address 27 to 01, enable checksum and use 2' s Complement Hexadecimal.	

※Effect after reboot, and Related Commands: \$AA2

5.2.4 #AA

Description	
Reads the data from all analog input channels.	

Syntax	
#AA[CHKSUM](CR)	
#	Delimiter character
AA	The address of the module to be read in hexadecimal format (01 to FF)

Response	
Valid Command	>(Data)[CHECKSUM](CR)
Invalid Command	?AA[CHECKSUM](CR)
>	Delimiter character to indicate a valid command
?	Delimiter character to indicate an invalid command
(Data)	The data from all the Analog Input channels.
AA	The address of the responding module in hexadecimal format (01 to FF)
There will be no response if the command syntax is incorrect, there is a communication error, or there is no module with the specified address.	

Examples	
Command	#1B
Response	>+098.90-035.90
Reads data from the Analog Input channels of module 27 and returns a response indicating that the command was successful, with the data from all Analog Input channels in engineering units format. (+098.90 = +98.9°C, -035.90=-35.9°C)	

Examples	
Command	#1B
Response	>788FD43B
Reads the Analog Input channels of module 27 and returns a response indicating that the command was successful, with the data from all Analog Input channels in hexadecimal format. (788F=+98.9°C, D43B=-35.9°C)	

Examples	
Command	#1B
Response	>+9999.9-9999.9
Reads the Analog Input channels of module 27, and returns a response indicating that the command was successful, but that the data is over/under range.	

※Related Commands: %AANNTTCCFF、\$AA2

5.2.5 #AAN

Description	
This command is used to read data from a specific Analog Input channel of a specified module.	

Syntax	
#AAN[CHKSUM](CR)	
#	Delimiter character.
AA	The address of the module to be read in hexadecimal format (01 to FF).
N	The Analog Input channel to be read, zero based.

Response	
Valid Command	>(Data)[CHECKSUM](CR)
Invalid Command	?AA[CHECKSUM](CR)
>	Delimiter character to indicate a valid command.
?	Delimiter character to indicate an invalid command.
(Data)	The data from the specified Analog Input channel.
AA	The address of the responding module in hexadecimal format (01 to FF)
There will be no response if the command syntax is incorrect, there is a communication error, or there is no module with the specified address.	

Examples	
Command	#1B0
Response	>+098.90
Reads data from Analog Input channel 1 of module 27 and returns a response indicating that the command was successful, and that the Analog Input value in engineering units format. (+098.90 = +98.9°C)	

Examples	
Command	#1B7
Response	>788F
Reads data from Analog Input channel 8 of module 27 and returns a response indicating that the command was successful, and that the Analog Input value in hexadecimal format. (788F = +98.9°C)	

Examples	
Command	#1B8
Response	?1B
Read data from Analog Input channel 9 of module 27, but Analog Input channel 8 does not exist.	

※Related Commands: %AANNTTCFF、\$AA2

5.2.6 \$AA0Ci

Description	
Performs an Analog Input Zero Calibration of a Specific Channel on the Module.	

Syntax	
\$AA0Ci[CHKSUM](CR)	
\$	Delimiter character
AA	The address of the module to be calibrated in hexadecimal format (01 to FF)
0	Command for zero calibration.
Ci	The Analog Input channel, zero based.

Response	
Valid Command	!AA[CHECKSUM](CR)
Invalid Command	?AA[CHECKSUM](CR)
!	Delimiter character to indicate a valid command
?	Delimiter character to indicate an invalid command
AA	The address of the responding module in hexadecimal format (01 to FF)
There will be no response if the command syntax is incorrect, there is a communication error, or there is no module with the specified address.	

Examples	
Command	\$010C0
Response	!1B
Performs zero calibration of channel 1 in address 01, and returns a response indicating that the command was successful.	

Examples	
Command	\$1B0C5
Response	!1B
Performs zero calibration of channel 6 in address 27, and returns a response indicating that the command was successful.	

Examples	
Command	\$1C0C1
Response	?1C
Performs zero calibration of channel 2 in address 28, and returns a response indicating that the command was not successful. Because the module don't perform "Enabled/Disabled calibration" command.	

※Related Commands: \$AA1Ci、~AAEV

5.2.7 \$AA1Ci

Description	
Performs an Analog Input Span Calibration of a Specific Channel on the Module.	

Syntax	
\$AA1Ci[CHKSUM](CR)	
\$	Delimiter character
AA	The address of the module to be trimmed in hexadecimal format (01 to FF)
1	Command for span calibration.
Ci	The Analog Input channel, zero based.

Response	
Valid Command	!AA[CHECKSUM](CR)
Invalid Command	?AA[CHECKSUM](CR)
!	Delimiter character to indicate a valid command
?	Delimiter character to indicate a invalid command
AA	The address of the responding module in hexadecimal format (01 to FF)
There will be no response if the command syntax is incorrect, there is a communication error, or there is no module with the specified address.	

Examples	
Command	\$011C0
Response	!1B
Performs span calibration of channel 1 in address 01, and returns a response indicating that the command was successful.	

Examples	
Command	\$1B1C5
Response	!1B
Performs span calibration of channel 6 in address 27, and returns a response indicating that the command was successful.	

Examples	
Command	\$1C1C1
Response	?1C
Performs span calibration of channel 2 in address 28, and returns a response indicating that the command was not successful. Because the module don't perform "Enabled/Disabled calibration" command.	

※Related Commands: \$AA0Ci、~AAEV

5.2.8 \$AA0

Description	
Performs an Analog Input Span Calibration of all Channels on the Module.	

Syntax	
\$AA0[CHKSUM](CR)	
\$	Delimiter character.
AA	The address of the module to be trimmed in hexadecimal format (01 to FF)
0	Command for span calibration.

Response	
Valid Command	!AA[CHECKSUM](CR)
Invalid Command	?AA[CHECKSUM](CR)
!	Delimiter character to indicate a valid command.
?	Delimiter character to indicate an invalid command.
AA	The address of the responding module in hexadecimal format (01 to FF)
There will be no response if the command syntax is incorrect, there is a communication error, or there is no module with the specified address.	

Examples	
Command	\$1B0
Response	!1B
Performs span calibration of all channels in address 27, and returns a response indicating that the command was successful.	

Examples	
Command	\$1C0
Response	?1C
Performs span calibration of all channels in address 28, and returns a response indicating that the command was not successful. Because the module don't perform "Enabled/Disabled calibration" command.	

※Related Commands: \$AA1、~AAEV

5.2.9 \$AA1

Description	
Performs an Analog Input Zero Calibration on the Module.	

Syntax	
\$AA1[CHKSUM](CR)	
\$	Delimiter character
AA	The address of the module to be calibrated in hexadecimal format(01 to FF)
1	Command for zero calibration.

Response	
Valid Command	!AA[CHECKSUM](CR)
Invalid Command	?AA[CHECKSUM](CR)
!	Delimiter character to indicate a valid command
?	Delimiter character to indicate an invalid command.
AA	The address of the responding module in hexadecimal format (01 to FF)
There will be no response if the command syntax is incorrect, there is a communication error, or there is no module with the specified address.	

Examples	
Command	\$1B1
Response	!1B
Performs zero calibration of all channels in address 27, and returns a response indicating that the command was successful.	

Examples	
Command	\$1C1
Response	?1C
Performs zero calibration of all channels in address 28, and returns a response indicating that the command was not successful. Because the module don't perform "Enabled/Disabled calibration" command.	

※Related Commands: \$AA0、~AAEV

5.2.10 \$AA2

Description	
This command is used to read the configuration of a specified module.	

Syntax	
\$AA2[CHKSUM](CR)	
\$	Delimiter character.
AA	The address of the module to be read in hexadecimal format (01 to FF)
2	The command to read the configuration of the module.

Response	
Valid Command	!NNTTCCFF[CHECKSUM](CR)
Invalid Command	?AA[CHECKSUM](CR)
!	Delimiter character to indicate a valid command.
?	Delimiter character to indicate an invalid command.
NN	The address of the module that is saved in the Flash ROM in hexadecimal format(01 to FF)
TT	00 (Reserved)
CC	0A (Reserved)
FF	The data format and checksum for the module. See Section 4.2 for details of the data format. 00 : Disabled checksum, and use Engineering units. 40 : Enabled checksum, and use Engineering units. 02 : Disabled checksum, and use 2' s Complement Hexadecimal. 42 : Enabled checksum, and use 2' s Complement Hexadecimal.
There will be no response if the command syntax is incorrect, there is a communication error, or there is no module with the specified address.	

Examples	
Command	\$1B2
Response	!1B000000
Reading the configuration of module address 27, and returns a response indicating that the command was successful. The configuration is disabled checksum and use Engineering units.	

Examples	
Command	\$1C2
Response	!1C000042
Reading the configuration of module address 28, and returns a response indicating that the command was successful. The configuration is enabled checksum and use 2' s Complement Hexadecimal.	

※Related Commands: %AANNTTCCFF

5.2.11 \$AA5VV

Description	
This command is used to specify the Analog Input channels to be enabled on a specified module.	

Syntax	
\$AA5VV[CHKSUM](CR)	
\$	Delimiter character.
AA	The address of the module to be set in hexadecimal format (01 to FF)
5	The command to enable the Analog Input channels.
VV	A two-digit hexadecimal value representing the Analog Input channel, where bit 0 corresponds to channel 0, and bit 1 corresponds to channel 1, etc. When the bit is 0, it denotes that the channel is to be disabled, and 1 denotes that the channel is to be enabled. For example, B2 = 10110010b = enabled channel 2,5,6 and 8; disabled channel 1,3,4 and 7.

Response	
Valid Command	!AA[CHECKSUM](CR)
Invalid Command	?AA[CHECKSUM](CR)
!	Delimiter character to indicate a valid command.
?	Delimiter character to indicate an invalid command.
AA	The address of the responding module in hexadecimal format (01 to FF)
There will be no response if the command syntax is incorrect, there is a communication error, or there is no module with the specified address.	

Examples	
Command	\$1B5B2
Response	!1B
Setting module address 27 to enable channel 2, 5, 6 and 8 / disabled channel 1, 3, 4 and 7, and returns a response indicating that the command was successful.	

※Related Commands: \$AA6

5.2.12 \$AA6

Description	
This command is used to read whether each Analog Input channel of a specified module is either enabled or disabled.	

Syntax	
\$AA6[CHKSUM](CR)	
\$	Delimiter character.
AA	The address of the module to be read in hexadecimal format (01 to FF)
6	The command to read the status of the Analog Input channels.

Response	
Valid Command	!AA[CHECKSUM](CR)
Invalid Command	?AA[CHECKSUM](CR)
!	Delimiter character to indicate a valid command.
?	Delimiter character to indicate an invalid command.
AA	The address of the responding module in hexadecimal format (01 to FF)
VV	A two-digit hexadecimal value representing the Analog Input channel, where bit 0 corresponds to channel 0, and bit 1 corresponds to channel 1, etc. When the bit is 0, it denotes that the channel is to be disabled, and 1 denotes that the channel is to be enabled. For example, B2 = 10110010b = enabled channel 2,5,6 and 8; disabled channel 1,3,4 and 7.
There will be no response if the command syntax is incorrect, there is a communication error, or there is no module with the specified address.	

Examples	
Command	\$1B6
Response	!1BB2
Reading module address 27 to enable channel 2, 5, 6 and 8 / disabled channel 1, 3, 4 and 7, and returns a response indicating that the command was successful.	

※Related Commands: \$AA5W

5.2.13 \$AAF

Description	
This command is used to read the firmware version of a specified module.	

Syntax	
\$AAF[CHKSUM](CR)	
\$	Delimiter character.
AA	The address of the module to be read in hexadecimal format (01 to FF)
F	The command to read the firmware version information

Response	
Valid Command	!AA(Data)[CHKSUM](CR)
Invalid Command	?AA[CHKSUM](CR)
!	Delimiter character to indicate a valid command.
?	Delimiter character to indicate an invalid command.
AA	The address of the responding module in hexadecimal format (01 to FF)
(Data)	The firmware version of the module as a string value.
There will be no response if the command syntax is incorrect, there is a communication error, or there is no module with the specified address.	

Examples	
Command	\$1BF
Response	!1B01.00□
Reads the firmware version of module 27 and returns a response indicating that the command was successful, and showing that the firmware is version 01.00.	

5.2.14 \$AAM

Description	
This command is used to read the name of a specified module.	

Syntax	
\$AAM[CHKSUM](CR)	
\$	Delimiter character.
AA	The address of the module to be read in hexadecimal format (01 to FF)
M	The command to read the name of the module.

Response	
Valid Command	!AA(Data)[CHKSUM](CR)
Invalid Command	?AA[CHKSUM](CR)
!	Delimiter character to indicate a valid command.
?	Delimiter character to indicate an invalid command.
AA	The address of the responding module in hexadecimal format (01 to FF)
(Data)	The name of the module as a string value.
There will be no response if the command syntax is incorrect, there is a communication error, or there is no module with the specified address.	

Examples	
Command	\$1BM
Response	!1BZT-2005-C8□
Reads the name of module 27 and returns a response indicating that the command was successful, and that the name of the module is "ZT-2005-C8".	

5.2.15 \$AAP

Description	
Reads the communication protocol information.	

Syntax	
\$AAP[CHKSUM](CR)	
\$	Delimiter character
AA	The address of the module to be read in hexadecimal format (01 to FF)
P	Command to read the communication protocol

Response	
Valid Response	!AASC[CHKSUM](CR)
Invalid Response	?AA[CHKSUM](CR)
!	Delimiter character for a valid response
?	Delimiter character for an invalid response
AA	The address of the responding module in hexadecimal format (01 to FF)
S	The protocols supported by the module.
	0 : DCON ◦ 1 : DCON and Modbus RTU ◦
C	Current protocol saved in EEPROM that will be used at the next power on reset.
	0 : DCON ◦ 1 : Modbus RTU ◦

There will be no response if the command syntax is incorrect, there is a communication error, or there is no module with the specified address.

Examples	
Command	\$1BP
Response	!1B10
Reads the communication protocol of module 27 and returns a response of 00 meaning that it supports the DCON, Modbus RTU protocols, and the protocol that will be used at the next power on reset is DCON.	

5.2.16 \$AAS1

Description	
This command is used to reload the factory default calibration parameters for a specified module, including the internal calibration parameters.	

Syntax	
\$AAS1[CHKSUM](CR)	
\$	Delimiter character
AA	The address of the module where the default parameters are to be reloaded in hexadecimal format (01 to FF)
S1	The command to reload the factory default calibration parameters.

Response	
Valid Command	!AASC[CHKSUM](CR)
Invalid Command	?AA[CHKSUM](CR)
!	Delimiter character to indicate a valid command
?	Delimiter character to indicate an invalid command
AA	The address of the responding module in hexadecimal format (01 to FF)
There will be no response if the command syntax is incorrect, there is a communication error, or there is no module with the specified address.	

Examples	
Command	\$1BS1
Response	!1B
Sends a command to reload the factory default calibration parameters for module 27 and returns a response indicating that the command was successful.	

5.2.17 ~AAD

Description	
Reads the temperature scale information of a module.	

Syntax	
~AAD[CHKSUM](CR)	
~	Delimiter character
AA	The address of the responding module in hexadecimal format (01 to FF)
D	Command to read the temperature scale

Response	
Valid Command	!AAT[CHKSUM](CR)
Invalid Command	?AA[CHKSUM](CR)
!	Delimiter character to indicate a valid command
?	Delimiter character to indicate an invalid command
AA	The address of the responding module in hexadecimal format (01 to FF)
T	Temperature scale 0: the temperature scale is Celsius. 1: the temperature scale is Fahrenheit.
There will be no response if the command syntax is incorrect, there is a communication error, or there is no module with the specified address.	

Examples	
Command	~1BD
Response	!1B0
Reads the temperature scale of module 27 and returns Celsius.	

※Related Commands:~AADT

5.2.18 ~AADT

Description	
Sets the temperature scale of a module to Celsius or Fahrenheit.	

Syntax	
~AADT[CHKSUM](CR)	
~	Delimiter character.
AA	The address of the module to be read in hexadecimal format (01 to FF).
D	Command to set the temperature scale.
T	C: set the temperature scale to Celsius. F: set the temperature scale to Fahrenheit.

Response	
Valid Command	!AA[CHKSUM](CR)
Invalid Command	?AA[CHKSUM](CR)
!	Delimiter character to indicate a valid command.
?	Delimiter character to indicate an invalid command.
AA	The address of the responding module in hexadecimal format (01 to FF)
There will be no response if the command syntax is incorrect, there is a communication error, or there is no module with the specified address.	

Examples	
Command	~1BDC
Response	!1B
Sets the temperature scale of module 27 to Celsius, and returns a valid response.	

Examples	
Command	~1BDF
Response	!1B
Sets the temperature scale of module 27 to Fahrenheit, and returns a valid response.	

※Related Commands:~AAD

5.2.19 ~AAEV

Description	
Sets to enable or disable calibration.	

Syntax	
~AAEV[CHKSUM](CR)	
~	Delimiter character.
AA	The address of the module to be read in hexadecimal format (01 to FF).
E	Command to enable or disable calibration.
V	Enable or disable. 0: Disable calibration 1: Enable calibration

Response	
Valid Command	!AA[CHKSUM](CR)
Invalid Command	?AA[CHKSUM](CR)
!	Delimiter character to indicate a valid command.
?	Delimiter character to indicate an invalid command.
AA	The address of the responding module in hexadecimal format (01 to FF)
There will be no response if the command syntax is incorrect, there is a communication error, or there is no module with the specified address.	

Examples	
Command	~1BE1
Response	!1B
Enabled calibration of module address 27, and returns a valid response.	

※Related Commands:\$AA0、\$AA1、\$AA0Ci、\$AA1Ci

5.2.20 ~AARE

Description	
Read RF Encryption Setting	

Syntax	
~AARE[CHKSUM](CR)	
~	Delimiter character.
AA	The address of the module to be read in hexadecimal format (01 to FF).
RE	Command to read RF Encryption Setting.

Response	
Valid Command	!AA[CHKSUM](CR)
Invalid Command	?AA[CHKSUM](CR)
!	Delimiter character to indicate a valid command.
?	Delimiter character to indicate an invalid command.
AA	The address of the responding module in hexadecimal format (01 to FF)
s	Whether support AES 128 encryption function. 0: Not support, 1: Support.
c	Already enable or disable AES 128 encryption. 0: Disable, 1: Enable.
There will be no response if the command syntax is incorrect, there is a communication error, or there is no module with the specified address.	

Examples	
Command	~1BRE
Response	!1B11
Read the RF encryption status of module address 27, and returns a valid response that module supports encryption function and already be enabled.	

※ZT-2005-C8 will follow the wireless data format of ZT-2550 or ZT-2570, and enable or disable encryption AES 128 encryption automatically, so users don't need to set again.

5.2.21 @AAA2CiToo

Description	
This command is used to set the offset of temperature for a specific Analog Input channel.	

Syntax	
@AAA2CiToo[CHKSUM](CR)	
@	Delimiter character.
AA	The address of the module to be read in hexadecimal format (01 to FF).
A2	Command to set the offset of temperature for a specific Analog Input channel.
Ci	The number of channels. (The first channel is channel 0)
Too	The offset value of °C or °F. The range of oo is -12.8°C to 12.7°C, or -12.8°F to 12.7°F. For example, oo equal to 01 is mean that +0.1°C, oo equal to 02 is mean that +0.2°C, oo equal to FF is mean that -0.1°C, oo equal to FE is mean that -0.2°C.

Response	
Valid Command	!AA[CHKSUM](CR)
Invalid Command	?AA[CHKSUM](CR)
!	Delimiter character to indicate a valid command.
?	Delimiter character to indicate an invalid command.
AA	The address of the responding module in hexadecimal format (01 to FF)
There will be no response if the command syntax is incorrect, there is a communication error, or there is no module with the specified address.	

Examples	
Command	@1BA2C0T0A
Response	!1B
Sets the offset value +1.0°C of channel 0 in module address 27, and returns a valid response.	

Examples	
Command	@1BA2C5TF0
Response	!1B
Sets the offset value -1.6°C of channel 5 in module address 27, and returns a valid response.	

※Related Commands:@AAA3Ci

5.2.22 @AAA3Ci

Description	
This command is used to read the offset of temperature for a specific Analog Input channel.	

Syntax	
@AAA3Ci[CHKSUM](CR)	
@	Delimiter character.
AA	The address of the module to be read in hexadecimal format (01 to FF).
A3	Command to read the offset of temperature for a specific Analog Input channel.
Ci	The number of channels. (The first channel is channel 0)

Response	
Valid Command	!AA[CHKSUM](CR)
Invalid Command	?AA[CHKSUM](CR)
!	Delimiter character to indicate a valid command.
?	Delimiter character to indicate an invalid command.
AA	The address of the responding module in hexadecimal format (01 to FF)
There will be no response if the command syntax is incorrect, there is a communication error, or there is no module with the specified address.	

Examples	
Command	@1BA3C0
Response	!1B03
Reads the offset value +0.3°C of channel 0 from module address 27, and returns a valid response.	

Examples	
Command	@1BA2C5
Response	!1BFC
Reads the offset value -0.4°C of channel 5 from module address 27, and returns a valid response.	

※Related Commands:@AAA2CiToo

5.3 Modbus RTU Protocol

The Modbus protocol was originally developed for Modicon controllers by Modicon Inc. Detailed information related to the Modbus RTU protocol can be found at <http://www.modbus.org> for more valuable information.

The Modbus RTU functions of ZT-2005-C8 module are supported as bellow.

Field 1	Field 2	Field 3	Field 4~n	Field n+1~n+2
Module Address	Function Code	Sub Function	Configuration Field	CRC16

Function Code	Description	Section
1 (0x01)	Read Coils	5.3.2
2 (0x02)	Read Discrete Inputs	5.3.3
3 (0x03)	Read Multiple Registers	5.3.4
4 (0x04)	Read Multiple Input Registers	5.3.5
5 (0x05)	Write Single Coil	5.3.6
6 (0x06)	Write Single Register	5.3.7
15 (0x0F)	Write Multiple Coils	5.3.8
16 (0x10)	Write Multiple Registers	5.3.9
70 (0x46)	Read/Write Module Setting	5.3.10

If the function specified in the message is not supported, then the module responds as below. Note that the address mapping for the Modbus protocol is Base 0.

Error Response

Byte	Description	Value
00	Module Address	1~247
01	Function Code	Function Code+0x80
02	Exception Code	02 : Register not support 03 : Modbus format invalid

Note: If a CRC mismatch occurs, the module will not respond.

5.3.1 Modbus Address Mapping Coils

Function Code		Address	Description	Attribute
0x01(R) 0x05(W) 0x0F(W)	0x02(R)			
00257	10257		Protocol , 0 : DCON ; 1 : Modbus RTU	R
00267	10267		Temperature scale , 0 : Celsius(°C) , 1 : Fahrenheit(°F)	R/W
00269	10269		Data format , 0 : 2' s complement hexadecimal 1 : Engineering units	R/W
00272	-		Write 1 to load default calibration parameters	W
00287	10287		RF Encryption status	R
00321	10321		DIP switch 12 to 1	R
~	~			
00332	10332			
00333	10333		Rotary switch Bit 0 to Bit 3	R
~	~			
00336	10336			

Registers

Function code		Address	Description	Attribute
0x04(R)	0x03(R) 0x06(W) 0x10(W)			
30001	40001		Temperature value of channel 0 to 7	R
~	~			
30008	40008			
30287	40287		RF Encryption status	R
30289	40289		Temperature offset of channel 0 to 7 (offset unit: 0.1)	R/W
~	~			
30296	40296			
30481	40481		Firmware version (Low word)	R
30482	40482		Firmware version (High word)	R
30483	40483		Module name (Low word)	R
30484	40484		Module name (High word)	R
30485	40485		Module address (Address/Node ID), valid range:1~247	R/W
30486	40486		Baud rate. Always set to 0x0A (115200,8,n,1)	R
30490	40490		Enables or disables each Analog Input channel	R/W

5.3.2 Function 01(0x01)-Read Coils

Description	
This function code is used to read the value at addresses 0xxxx.	

Syntax		
Byte	Description	Value
00	Module address	1~247
01	Function Code	0x01
02~03	Reference Address	Refer to section 5.3.1, Address 0xxxx
04~05	Bit Count	Number of bit(B) to read
06~07	Checksum (CRC16)	Two bytes checksum

Response		
Byte	Description	Value
00	Module address	1~247
01	Function Code	0x01
02	Byte Count	Response data byte N=B/7
03~(N+2)	Bit Value	Response bit data
(N+3)~(N+4)	Checksum (CRC16)	Two bytes checksum

Error Response		
Byte	Description	Value
00	Module address	1~247
01	Function Code	0x81
02	Exception Code	Refrt to section 5.3
03~04	Checksum (CRC16)	Two bytes checksum

Examples	
Command	1A 01 01 0A 00 01 [DF DF]
Response	1A 01 01 00 [57 6C]
Reads the temperature scale of module address 26, and response 0: Celsius(°C).	
Response	1A 01 01 01 [96 AC]
Reads the temperature scale of module address 26, and response 1: Fahrenheit(°F).	

5.3.3 Function 02(0x02)-Read Discrete Inputs

Description	
This function code is used to read the value at addresses 1xxxx.	

Syntax		
Byte	Description	Value
00	Module address	1~247
01	Function Code	0x02
02~03	Reference Address	Refer to section 5.3.1, Address 1xxxx
04~05	Bit Count	Number of bit(B) to read
06~07	Checksum (CRC16)	Two bytes checksum

Response		
Byte	Description	Value
00	Module address	1~247
01	Function Code	0x02
02	Byte Count	Response data byte N=B/7
03~(N+2)	Bit Value	Response bit data
(N+3)~(N+4)	Checksum (CRC16)	Two bytes checksum

Error Response		
Byte	Description	Value
00	Module address	1~247
01	Function Code	0x82
02	Exception Code	Refrt to section 5.3
03~04	Checksum (CRC16)	Two bytes checksum

Examples	
Command	1A 02 01 0A 00 01 [9B DF]
Response	1A 02 01 00 [A7 6C]
Reads the temperature scale of module address 26, and response 0: Celsius(°C).	
Response	1A 02 01 01 [66 AC]
Reads the temperature scale of module address 26, and response 1: Fahrenheit(°F).	

5.3.4 Function 03(0x03)-Read Multiple Registers

Description	
This function code is used to read the value at addresses 4xxxx.	

Syntax		
Byte	Description	Value
00	Module address	1~247
01	Function Code	0x03
02~03	Reference Address	Refer to section 5.3.1, Address 1xxxx
04~05	Word Count	Number of word(W) to read
06~07	Checksum (CRC16)	Two bytes checksum

Response		
Byte	Description	Value
00	Module address	1~247
01	Function Code	0x03
02	Byte Count	Response data byte N = W x 2
03~(N+2)	Word Value	Response word data
(N+3)~(N+4)	Checksum (CRC16)	Two bytes checksum

Error Response		
Byte	Description	Value
00	Module address	1~247
01	Function Code	0x83
02	Exception Code	Refer to section 5.3
03~04	Checksum (CRC16)	Two bytes checksum

Examples	
Command	1A 03 00 00 00 08 [47 E7]
Response	1A 03 10 1C 86 80 00 80 00 80 00 80 00 80 00 80 00 [53 62]
Reads temperature value of 8 channels from module address 26, and response channel 0 is 23.4°C, channel 1 to 7 are under range.	
Examples	
Command	1A 03 00 01 00 05 [D7 E2]
Response	1A 03 0A 80 00 1C 86 80 00 1C E3 80 00 [69 B2]
Reads temperature value of channel 1 to 5 from module address 26, and response channel 1, 3, 5 are under range, channel 2, 4 are 23.4°C and 23.7°C.	

5.3.5 Function 04(0x04)-Read Multiple Input Registers

Description	
This function code is used to read the value at addresses 3xxxx.	

Syntax		
Byte	Description	Value
00	Module address	1~247
01	Function Code	0x04
02~03	Reference Address	Refer to section 5.3.1, Address 1xxxx
04~05	Word Count	Number of word(W) to read
06~07	Checksum (CRC16)	Two bytes checksum

Response		
Byte	Description	Value
00	Module address	1~247
01	Function Code	0x04
02	Byte Count	Response data byte N = W x 2
03~(N+2)	Word Value	Response word data
(N+3)~(N+4)	Checksum (CRC16)	Two bytes checksum

Error Response		
Byte	Description	Value
00	Module address	1~247
01	Function Code	0x84
02	Exception Code	Refrt to section 5.3
03~04	Checksum (CRC16)	Two bytes checksum

Examples	
Command	1A 04 00 00 00 08 [F2 27]
Response	1A 04 10 1C 86 80 00 80 00 80 00 80 00 80 00 80 00 [E2 17]
Reads temperature value of 8 channels from module address 26, and reponse channel 0 is 23.4°C, channel 1 to 7 are under range. ◦	
Examples	
Command	1A 04 00 01 00 05 [62 22]
Response	1A 04 0A 80 00 1C 86 80 00 1C E3 80 00 [9C 79]
Reads temperature value of channel1 to 5 from module address 26, and reponse channel 1, 3, 5 are under range, channel 2, 4 are 23.4°C and 23.7°C.	

5.3.6 Fuction 05(0x05)-Write Single Coil

Description	
This function code is used to write a value to addresses 0xxxx.	

Syntax		
Byte	Description	Value
00	Module address	1~247
01	Function Code	0x05
02~03	Reference Address	Refer to section 5.3.1, Address 0xxxx
04~05	Output Value	Output ON: 0x0001 Output OFF: 0x0000
06~07	Checksum (CRC16)	Two bytes checksum

Response		
Byte	Description	Value
00	Module address	1~247
01	Function Code	0x05
02~03	Byte Count	The same as byte 02~03 of request
04~05	Output Value	The same as byte 04~05 of request
06~07	Checksum (CRC16)	Two bytes checksum

Error Response		
Byte	Description	Value
00	Module address	1~247
01	Function Code	0x85
02	Exception Code	Refer to section 5.3
03~04	Checksum (CRC16)	Two bytes checksum

Examples	
Command	1A 05 01 0A 00 00 [EF DF]
Response	1A 05 01 00 [16 AD]
Writes the temperature scale 0 Celsius(°C) to module address 26.	

Examples	
Command	1A 05 01 0A FF 00 [AE 2F]
Response	1A 05 01 01 [D7 6D]
Writes the temperature scale 1 Fahrenheit(°F) to module address 26.	

5.3.7 Function 06(0x06)-Write Single Register

Description		
This function code is used to write a value to addresses 4xxxx.		

Syntax		
Byte	Description	Value
00	Module address	1~247
01	Function Code	0x06
02~03	Reference Address	Refer to section 5.3.1, Address 0xxxx
04~05	Output Value	A Word Value
06~07	Checksum (CRC16)	Two bytes checksum

Response		
Byte	Description	Value
00	Module address	1~247
01	Function Code	0x06
02~03	Reference Address	The same as byte 02~03 of request
04~05	Output Value	The same as byte 04~05 of request
06~07	Checksum (CRC16)	Two bytes checksum

Error Response		
Byte	Description	Value
00	Module address	1~247
01	Function Code	0x86
02	Exception Code	Refert to section 5.3
03~04	Checksum (CRC16)	Two bytes checksum

Examples		
Command	1A 06 01 20 00 7F [CB F7]	
Response	1A 06 01 20 00 7F [CB F7]	
Writes the temperature offset +12.7°C of channel 0 to module address 26.		

Examples		
Command	1A 06 01 27 FF 80 [7B 86]	
Response	1A 06 01 27 FF 80 [7B 86]	
Writes the temperature offset -12.8°C of channel 7 to module address 26.		

5.3.8 Function 15(0x0F)-Write Multiple Coils

Description		
This function code is used to write values to addresses 0xxxx.		

Syntax		
Byte	Description	Value
00	Module address	1~247
01	Function Code	0x0F
02~03	Reference Address	Refer to section 5.3.1, Address 0xxxx
04~05	Output Value	Output ON: 0x0001 Output OFF: 0x0000
06~07	Checksum (CRC16)	Two bytes checksum

Response		
Byte	Description	Value
00	Module address	1~247
01	Function Code	0x0F
02~03	Reference Address	The same as byte 02~03 of request
04~05	Output Value	The same as byte 04~05 of request
06~07	Checksum (CRC16)	Two bytes checksum

Error Response		
Byte	Description	Value
00	Module address	1~247
01	Function Code	0x8F
02	Exception Code	Refer to section 5.3
03~04	Checksum (CRC16)	Two bytes checksum

Examples	
Command	1A 0F 01 0A 00 01 01 00[F7 F8]
Response	1A 0F 01 0A 00 01 [B6 1E]
Writes the temperature scale 0 Celsius(°C) to module address 26.	

Examples	
Command	1A 0F 01 0A 00 01 01 01[36 38]
Response	1A 0F 01 0A 00 01 [B6 1E]
Writes the temperature scale 1 Fahrenheit(°F) to module address 26.	

5.3.9 Function 16(0x10)-Write Multiple Registers

Description	
This function code is used to write values to addresses 4xxxx.	

Syntax		
Byte	Description	Value
00	Module address	1~247
01	Function Code	0x10
02~03	Reference Address	Refer to section 5.3.1, Address 0xxxx
04~05	Word Count	Number of word (W) to write
06	Byte Count	Byte number N = W x 2
07~(N+6)	Write data	Multiple word data
(N+7)~ (N+8)	Checksum (CRC16)	Two bytes checksum

Response		
Byte	Description	Value
00	Module address	1~247
01	Function Code	0x10
02~03	Reference Address	The same as byte 02~03 of request
04~05	Output Value	The same as byte 04~05 of request
06~07	Checksum (CRC16)	Two bytes checksum

Error Response		
Byte	Description	Value
00	Module address	1~247
01	Function Code	0x90
02	Exception Code	Refert to section 5.3
03~04	Checksum (CRC16)	Two bytes checksum

Examples	
Command	1A 10 01 20 00 01 02 00 7F [4E E0]
Response	1A 10 01 20 00 01 [02 14]
Writes the temperature offset +12.7°C of channel 0 to module address 26.	

Examples	
Command	1A 10 01 27 00 01 02 FF 80 [4E E7]
Response	1A 10 01 27 00 01 [B3 D5]
Writes the temperature offset -12.8°C of channel 7 to module address 26.	

5.3.10 Function 70(0x46)–Read/Write Module Setting

Description		
This function code is used to read the configuration settings from the module or to change the settings for the module. The following sub-function codes are supported.		
Sub-function Code	Description	Section
00(0x00)	Read the name of the module	5.3.10.1
04(0x04)	Set the module address	5.3.10.2
05(0x05)	Read the communication settings	5.3.10.3
32(0x20)	Read the firmware version	5.3.10.4
37(0x25)	Read the channel enable/disable status	5.3.10.5
38(0x26)	Set the channel enable/disable	5.3.10.6

If the module does not support the sub-function code specified in the message, then it responds as follows.

Error Response		
Byte	Description	Value
00	Module address	1~247
01	Function Code	0xC6
02	Exception Code	Refrt to section 5.3
03~04	Checksum (CRC16)	Two bytes checksum

5.3.10.1 Sub-function 00(0x00)-Read Module Name

Description	
This sub-function code is used to read the name of a module.	

Syntax		
Byte	Description	Value
00	Module address	1~247
01	Function Code	0x46
02	Sub function code	0x00
03~04	Checksum (CRC16)	Two bytes checksum

Response		
Byte	Description	Value
00	Module address	1~247
01	Function Code	0x46
02	Sub function code	0x00
03~06	Module name	0x54 0x20 0x05 0xC8 (ZT-2005-C8)
07~08	Checksum (CRC16)	Two bytes checksum

Error Response		
Byte	Description	Value
00	Module address	1~247
01	Function Code	0xC6
02	Exception Code	Refrt to section 5.3
03~04	Checksum (CRC16)	Two bytes checksum

Examples	
Command	1A 46 00 [62 67]
Response	1A 46 00 54 20 05 C8 [BD 5B]
Reads the module name is ZT-2005-C8 from module address 26.	

5.3.10.2 Sub-function 04(0x04)-Write Module Address

Description	
This sub-function code is used to set the address of a module.	

Syntax		
Byte	Description	Value
00	Module address	1~247
01	Function Code	0x46
02	Sub function code	0x04
03	New module address	1~247
04~06	Reserved	0x00 0x00 0x00
07~08	Checksum (CRC16)	Two bytes checksum

Response		
Byte	Description	Value
00	Module address	1~247
01	Function Code	0x46
02	Sub function code	0x04
03	Set address result	0:OK Other: Error
04~06	Reserved	0x00 0x00 0x00
07~08	Checksum (CRC16)	Two bytes checksum

Error Response		
Byte	Description	Value
00	Module address	1~247
01	Function Code	0xC6
02	Exception Code	Refrt to section 5.3
03~04	Checksum (CRC16)	Two bytes checksum

Examples	
Command	1A 46 04 03 00 00 00 [5F E3]
Response	1A 46 04 00 00 00 00 [5F A7]
Sets the new module address 03 to module address 26, and return setting OK.	

5.3.10.3 Sub-function 05(0x05)-Read the communication setting

Description	
This sub-function code is used to read the communication protocol settings of a module.	

Syntax		
Byte	Description	Value
00	Module address	1~247
01	Function Code	0x46
02	Sub function code	0x05
03	Reserved	0x00

Response		
Byte	Description	Value
00	Module address	1~247
01	Function Code	0x46
02	Sub function code	0x05
03	Reserved	0x00
04	Baud Rate	0x0A , 115200
05	Reserved	0x00
06	Data format	0x00 , 8,n,1
07	Reserved	0x00
08	Mode	0x00 : DCON 0x01 : Modbus RTU
09~10	Reserved	0x00 0x00
11~12	Checksum (CRC16)	Two bytes checksum

Error Response		
Byte	Description	Value
00	Module address	1~247
01	Function Code	0xC6
02	Exception Code	Refrt to section 5.3
03~04	Checksum (CRC16)	Two bytes checksum

Examples	
Command	1A 46 05 00 [E5 B9]
Response	1A 46 05 00 0A 00 00 00 01 00 00 [55 A7]
Reads the mode from the flash ROM of module address 26 is Modbus RTU.	

5.3.10.4 Sub-function 32(0x20)-Read Module Firmware Version

Description		
This sub-function code is used to read the firmware version information of a module.		

Syntax		
Byte	Description	Value
00	Module address	1~247
01	Function Code	0x46
02	Sub function code	0x20
03~04	Checksum (CRC16)	Two bytes checksum

Response		
Byte	Description	Value
00	Module address	1~247
01	Function Code	0x46
02	Sub function code	0x20
03	Mainor version	0x00~0xFF
04	Minor version	0x00~0xFF
05	Build version	0x00~0xFF
07~08	Checksum (CRC16)	Two bytes checksum

Error Response		
Byte	Description	Value
00	Module address	1~247
01	Function Code	0xC6
02	Exception Code	Refirt to section 5.3
03~04	Checksum (CRC16)	Two bytes checksum

Examples	
Command	1A 46 20 [63 BF]
Response	1A 46 20 01 00 00 [D1 EE]
Reads the firmware version 1.0 from module address 26.	

5.3.10.5 Sub-function 37(0x25)-Read The Enabled/Disable status of Channels

Description		
This sub-function code is used to read the enabled/disabled status of each channel in a module.		

Syntax		
Byte	Description	Value
00	Module address	1~247
01	Function Code	0x46
02	Sub function code	0x25
03~04	Checksum (CRC16)	Two bytes checksum

Response		
Byte	Description	Value
00	Module address	1~247
01	Function Code	0x46
02	Sub function code	0x25
03	Enabled/Disabled status	0x00~0xFF, enabled/disabled status of each channel, where bit 0 corresponds to channel 0, bit 1 corresponds to channel 1, etc. When the bit is 1 it denotes that the channel is enabled and 0 denotes that the channel is disabled.
04~05	Checksum (CRC16)	Two bytes checksum

Error Response		
Byte	Description	Value
00	Module address	1~247
01	Function Code	0xC6
02	Exception Code	Refrt to section 5.3
03~04	Checksum (CRC16)	Two bytes checksum

Examples	
Command	1A 46 25 [A3 BC]
Response	1A 46 25 AA [7C 06]
Reads the enable/disable status of channels from module address 26, and reponse channel 0, 2, 4, 6 are disable, channel 1, 3, 5, 7 are enable.	

5.3.10.6 Sub-function 38(0x26)-Write The Enabled/Disable status of Channels

Description	
This sub-function code is used to specify the channels to be enabled in a module.	

Syntax		
Byte	Description	Value
00	Module address	1~247
01	Function Code	0x46
02	Sub function code	0x26
03	Enabled/Disabled status	0x00~0xFF, enabled/disabled status of each channel, where bit 0 corresponds to channel 0, bit 1 corresponds to channel 1, etc. When the bit is 1 it denotes that the channel is enabled and 0 denotes that the channel is disabled.
03~04	Checksum (CRC16)	Two bytes checksum

Response		
Byte	Description	Value
00	Module address	1~247
01	Function Code	0x46
02	Sub function code	0x26
03	Enabled/Disabled status	0 : OK Other : Error
04~05	Checksum (CRC16)	Two bytes checksum

Error Response		
Byte	Description	Value
00	Module address	1~247
01	Function Code	0xC6
02	Exception Code	Refrt to section 5.3
03~04	Checksum (CRC16)	Two bytes checksum

Examples	
Command	1A 46 26 AA [7C F6]
Response	1A 46 26 00 [FC 89]
Sets the enable/disable status of channels from module address 26, and reponse channel 0, 2, 4, 6 are disable, channel 1, 3, 5, 7 are enable.	

6

Troubleshooting

(1) Technical Support

If you have any difficulties using your ZT-2005-C8 device, please send a description of the problem to service@icpdas.com

Include the following items in your email:

- A description or diagram of the current DIP switch positions.
- A copy of the configuration file for the ZT-2000 coordinator. This file can be obtained using the procedure outlined below and should be attached to your email.

- A. Set the DIP switch of the ZT-255x device to the [ZBSET] position then reboot the device. Launch the ZT Configuration Utility and select [Save Log] icon to save the configuration of the ZT-255x as a file.



- B. After clicking the [Save Log] icon, enter the "File Name" and the "File Path" in the Windows "Save" dialog box. Once the configuration has been successfully saved, the following message will be displayed.

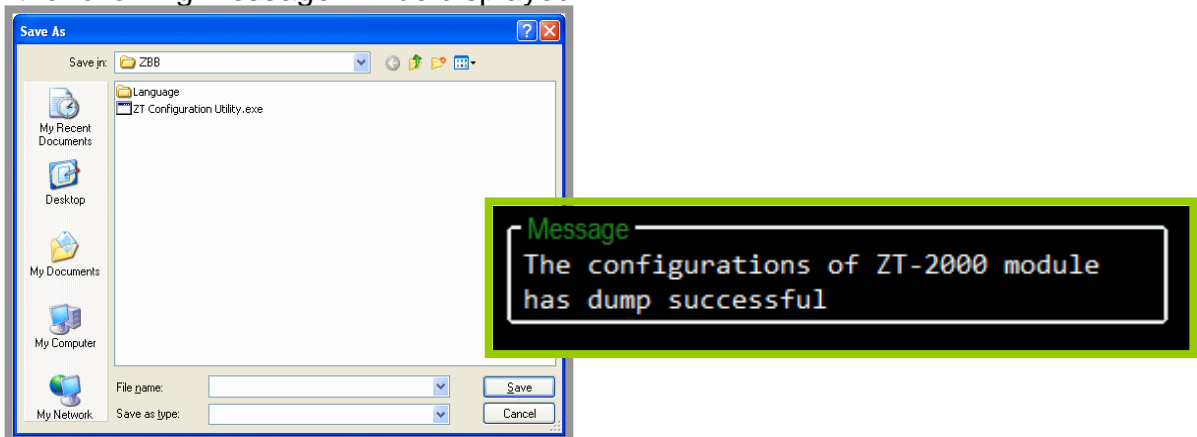

7 Appendix

7.1 LED Display Status

LED indicators is used to display the status of the power (PWR), the ZigBee network(ZBNET) and wireless data receiving(ZBRx).

LED	Status	Introduction
ZigBee Net (Green LED)	ZigBee Router (Slave)	
	Steady Lit	The Signal is Strong
	Blinking (500 ms)	The Signal is Available
	Blinking (1s)	The Signal is Weak
	Blinking (2s)	The Signal is Unstable or There is no Available
	Blinking irregularly	Module Node ID conflict, there are same Node IDs in the same network
ZigBee RxD (Yellow LED)	The status of ZigBee communication	
	Blinking	Receiving ZigBee Data
	Steady Unlit	No ZigBee Data Received
ZigBee PWR (Red LED)	The status of module power	
	Steady Lit	Power ON
	Steady Unlit	Power OFF

7.2 The Extension to the Software Address

There are only 31 adjustable addresses available to the DIP and rotary switches for the ZT-2005-C8 module. If there are any requirements for more range of addresses, there is a software configuration feature for the Address parameter.

If we attempt to configure the Address parameter, there are DCON and Modbus RTU command set provided. Please refer the details at the section 5.2.3

for DCON commands or the section 5.3.7 and 5.3.9 for Modbus RTU commands. In addition, we also can use DCON Utility to set the Address parameter for the more values of 1 to 247.

Finally, we only turn the Address of DIP and rotary switches to address 0 and reboot module, the software address will be enabled. The default software address is 0x01.