



# tWF-AD5 User's Manual

---

**[www.icpdas.com](http://www.icpdas.com)**

## Warranty

All products manufactured by ICP DAS are under warranty regarding defective materials for a period of one year from the date of delivery to the original purchaser.

## Warning

ICP DAS assumes no liability for damages resulting from the use of this product. ICP DAS reserves the right to change this manual at any time without notice. The information furnished by ICP DAS is believed to be accurate and reliable. However, no responsibility is assumed by ICP DAS for its use, or for any infringements of patents or other rights of third parties resulting from its use.

## Copyright

Copyright 2020 by ICP DAS. All rights are reserved.

## Trademark

The names used for identification only may be registered trademarks of their respective companies.



# tWF-AD5 User's Manual

---

## Document Revision

<b>Version</b>	<b>Date</b>	<b>Description of changes</b>
Rev1.0	2020-02-13	First release for tWF-AD5



# tWF-AD5 User's Manual

## Table of Contents

<b>1. Introduction.....</b>	<b>4</b>
<b>1.1 Wireless connection mode .....</b>	<b>4</b>
<b>1.2 Features.....</b>	<b>4</b>
1.2.2 Features Description .....	5
<b>1.3 Specifications.....</b>	<b>6</b>
<b>2. Hardware.....</b>	<b>8</b>
<b>2.1 Front Panel.....</b>	<b>8</b>
2.1.2 LED Indicator .....	8
2.1.3 tWF-AD5 Connector Pin Define.....	9
<b>2.2 Reset to default.....</b>	<b>9</b>
<b>2.3 Product Photo.....</b>	<b>10</b>
<b>2.4 Dimensions .....</b>	<b>11</b>
<b>2.5 Hardware Connection .....</b>	<b>12</b>
2.5.2 Power connection .....	12
2.5.3 I/O connection.....	12
<b>3. Software.....</b>	<b>13</b>
<b>3.1 tWF Analog Utility.....</b>	<b>13</b>
3.1.2 Main Screen.....	13
3.1.3 Configuration/Setup.....	18
<b>3.2 IP scanner.....</b>	<b>20</b>
<b>4. Application .....</b>	<b>21</b>
<b>4.1 Connection with Modbus TCP utility.....</b>	<b>21</b>
<b>5. Modbus Applications.....</b>	<b>24</b>
<b>5.1 What is Modbus TCP/IP? .....</b>	<b>24</b>
<b>5.2 Protocol Description .....</b>	<b>24</b>
5.2.1 MBAP .....	25
5.2.2 Function Code .....	25
5.2.3 Data .....	26
5.2.4 Response .....	26
5.2.5 Data Encoding.....	26
<b>5.3 Address Mapping.....</b>	<b>28</b>
5.3.1 tWF-AD5 I/O Address Mapping.....	28

## 1. Introduction

The tWF-AD5 module have 5 channel differential analog input as WLAN connection complies with the IEEE802.11b/g/n standards. With the popularity of 802.11 network infrastructure, the tWF-AD5 make an easy way to incorporate wireless connectivity into monitoring and control systems. They also support Modbus TCP protocol and the network encryption configuration, which makes perfect integration to SCADA software or HMI Modbus APP and offer easy and safe access for users from anytime and anywhere.



Figure 1-1: Application architecture for the tWF series

### 1.1 Wireless connection mode

tWF-AD5 module support both AP(Access Point ) & STA(Station) wireless connection modes of WLAN.

### 1.2 Features

- Wi-Fi communication remote Analog Input module
- Compatible with IEEE 802.11b/g/n standards
- Support Station(STA) and Access Point(Limited-AP, 1 Client) modes for wireless networks
- Support WEP, WPA and WPA2 wireless encryption
- Support Modbus TCP protocols
- Support DHCP Server(AP), DHCP Client or Static IP(STA) network configuration
- Wide operating temperature range & Power supply range
- Isolation differential voltage input
- 14/12 bit resolution in Normal/Fast mode
- Cost-effective



# tWF-AD5 User's Manual

---

## 1.2.2 Features Description

The tWF-AD5 offers the most comprehensive configuration to meet specific application requirements. The following list shows the features designed to simplify installation, configuration and application.

### **Compatible with IEEE 802.11b/g/n standards**

---

tWF-AD5 complied with IEEE 802.11b/g/n standard from 2.4~2.5 GHz, and it can be used to connect your wireless LAN.

### **Support STA(Station) and AP(Access Point) modes for wireless networks**

---

AP mode lets you create a Limited AP(1 Client access allow) network with the specified SSID to communicate directly with each other without the need for a wireless access point.

STA mode is the more common network configuration where all wireless hosts (clients) connect to the wireless network via a WAP (Wireless Access Point).

### **Support WEP, WPA and WPA2 wireless encryption**

---

WEP and WPA are common types of security that are used to protect wireless networks. When WEP or WPA is turned on, tWF-AD5 uses a special security key combination to allow only devices that know this key to connect to its wireless network. This applies to laptops, smart device, or any other wireless device.

### **Support Modbus TCP protocols**

---

The Modbus TCP server function on tWF-AD5 can be used to provide data remote with HMI/SCADA software built with Modbus TCP driver.

Also, there is some other HMI Modbus App in Android Google Play you can use.



# tWF-AD5 User's Manual

## 1.3 Specifications

Table 1-1: System Specifications

Module	tWF-AD5
<b>Wi-Fi Interface</b>	
Antenna	Chip Antenna
Output Power	18.0 dBm @ 1 DSSS / 14.5 dBm @ 54 OFDM
Receive Sensitivity	-95.7 dBm @ 1 DSSS / -74.0 dBm @ 54 OFDM
Standard Supported	IEEE 802.11b/g/n
Wireless Mode	Station & AP(1 Client)
Encryption	WEP, WPA and WPA2
<b>Power</b>	
Input Voltage Range	DC 9V ~ 48V
Power Consumption	0.84W
<b>Mechanism</b>	
Installation	DIN-Rail
Dimensions (W x L x H)	52 mm x 97 mm x 27 mm
<b>Environment</b>	
Operating Temperature	-20°C ~ +75°C
Storage Temperature	-30°C ~ +80°C
Humidity	10% ~ 95% RH, Non-condensing



# tWF-AD5 User's Manual

Table 1-2: I/O Specification

Module		tWF-AD5
<b>Analog Input</b>		
Input Channels		5
Input Type		$\pm 1.25\text{ V}$ , $\pm 2.5\text{ V}$ , $\pm 5\text{ V}$ , $\pm 10\text{ V}$
Resolution	Normal Mode	14-bit
	Fast Mode	12-bit
Sampling Rate	Normal Mode	14Hz (Max) total
	Fast Mode	180Hz (Max) total
Accuracy	Normal Mode	$\pm 0.1\%$
	Fast Mode	$\pm 0.5\%$
Zero Drift		$\pm 20\ \mu\text{V}/^\circ\text{C}$
Span Drift		$\pm 25\ \text{ppm}/^\circ\text{C}$
Input Impedance		20 M $\Omega$
Self-calibration Reference output		+2.50V $\pm 0.01\text{V}$

## 2. Hardware

### 2.1 Front Panel

The tWF-AD5 module front panel contains I/O connectors and LEDs.

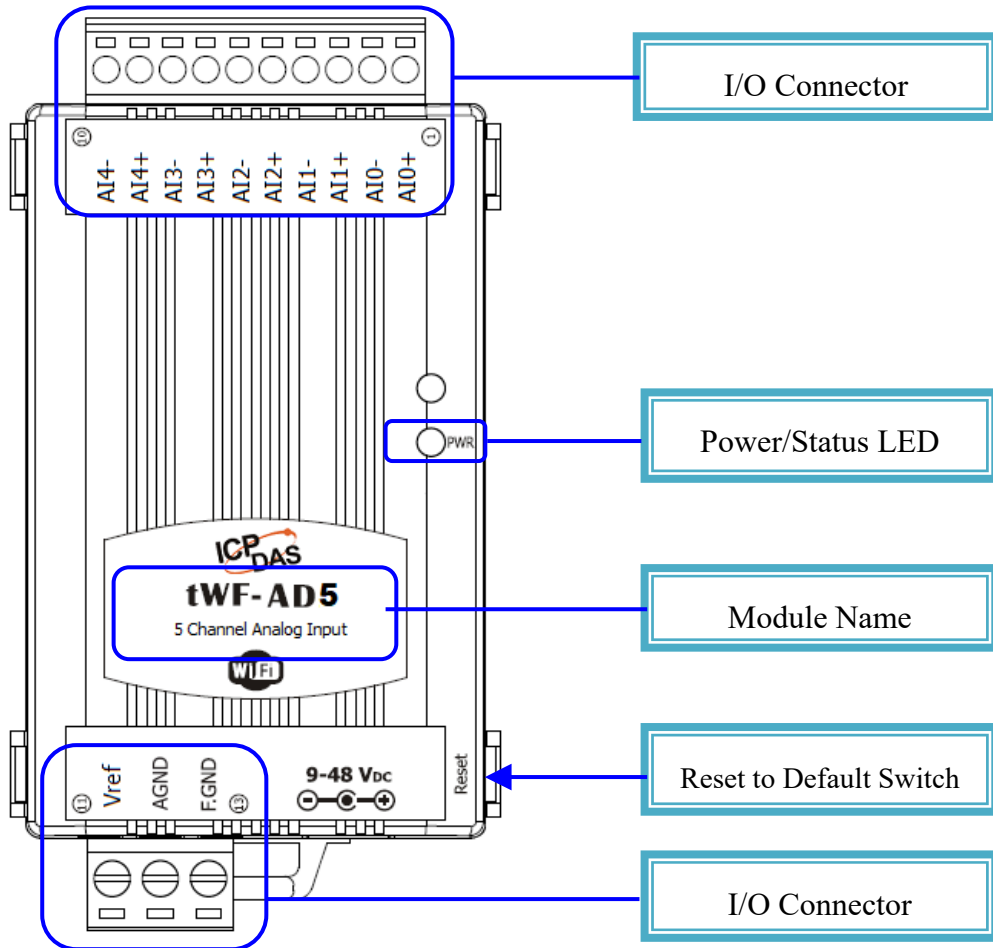

Figure 2-1: Front Panel of the tWF-AD5 module

#### 2.1.2 LED Indicator

Table 2-1: System Status Indicator

System Status Indicator		
LED	Module Status	LED Status
PWR	Wi-Fi get Link	Red LED ON
	Power On	Blue LED ON
	Locator	Red LED Blinking
	Process reset to default	Blue LED Blinking(Fast)



## 2.1.3 tWF-AD5 Connector Pin Define

Terminal NO	Pin Assignment Name
10	AI4-
9	AI4+
8	AI3-
7	AI3+
6	AI2-
5	AI2+
4	AI1-
3	AI1+
2	AI0-
1	AI0+

Terminal NO	Pin Assignment Name
11	Vref
12	AGND
13	F.GND

Figure 2-2: I/O Connector of tWF-AD5

## 2.2 Reset to default

Press & hold the reset button in right side over 6 Sec until the Red LED quick flash then release to restore tWF-AD5 default setting, default is set in AP mode.

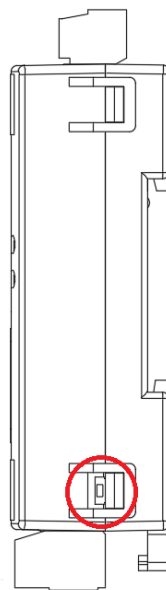

Figure 2-7: Reset button locate in the right side of tWF-AD5

## 2.3 Product Photo



## 2.4 Dimensions

The diagrams below provide the dimensions of the tWF series Controller/Module to use in defining your enclosure specifications. All dimensions are in millimeters.

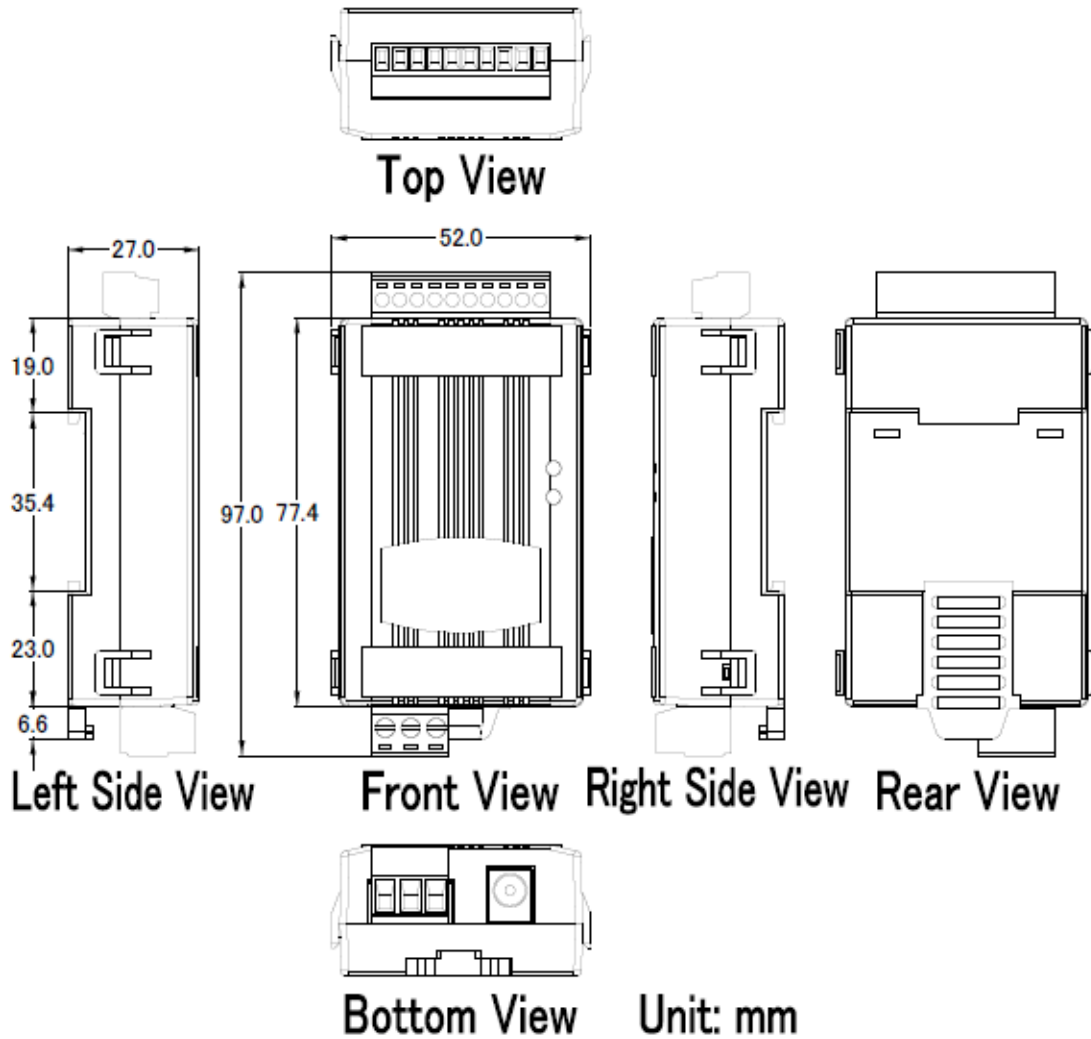
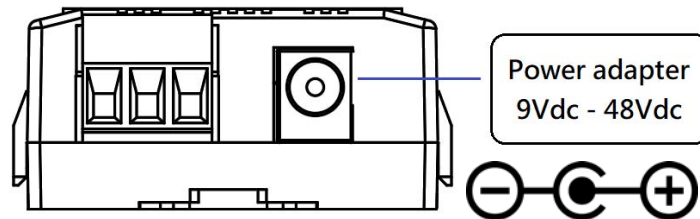

Figure 2-8: Dimension of the tWF series module

## 2.5 Hardware Connection

### 2.5.2 Power connection

The following figures describe the Power



Bottom side

Figure 2-9: Power connection

### 2.5.3 I/O connection

#### 2.5.3.1 Analog Input wiring

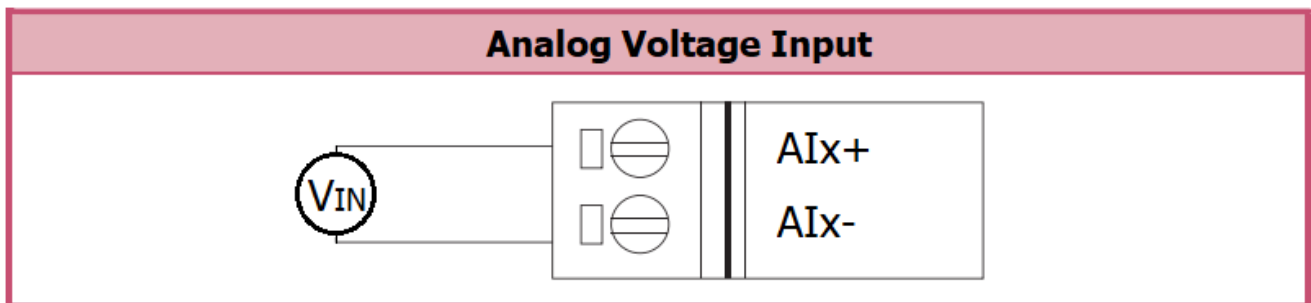

Figure 2-10: Analog Input wiring

## 3. Software

The tWF Analog Utility provides the simple way to operating and acquire I/O status. It used the wireless network interface to configure. Provide AP(Access Point) & STA(Station) mode to connect the tWF-AD5 module.

tWF Analog Utility available on both Windows & Android application, also it can work in Web browser to operating and configure the tWF-AD5 module.

**Utility Support Windows 7 (or later versions) and Android 6.0 (or later versions).**

### 3.1 tWF Analog Utility

The following is the main screens provided by tWF Analog Utility, these utility tools can be thought as a useful tool for I/O control and monitoring on the tWF-AD5 & tWF-TH8 module. It supplies several functions, such as monitoring, module connection, Wi-Fi configuration setting and F/W upgrade, etc.

#### 3.1.2 Main Screen

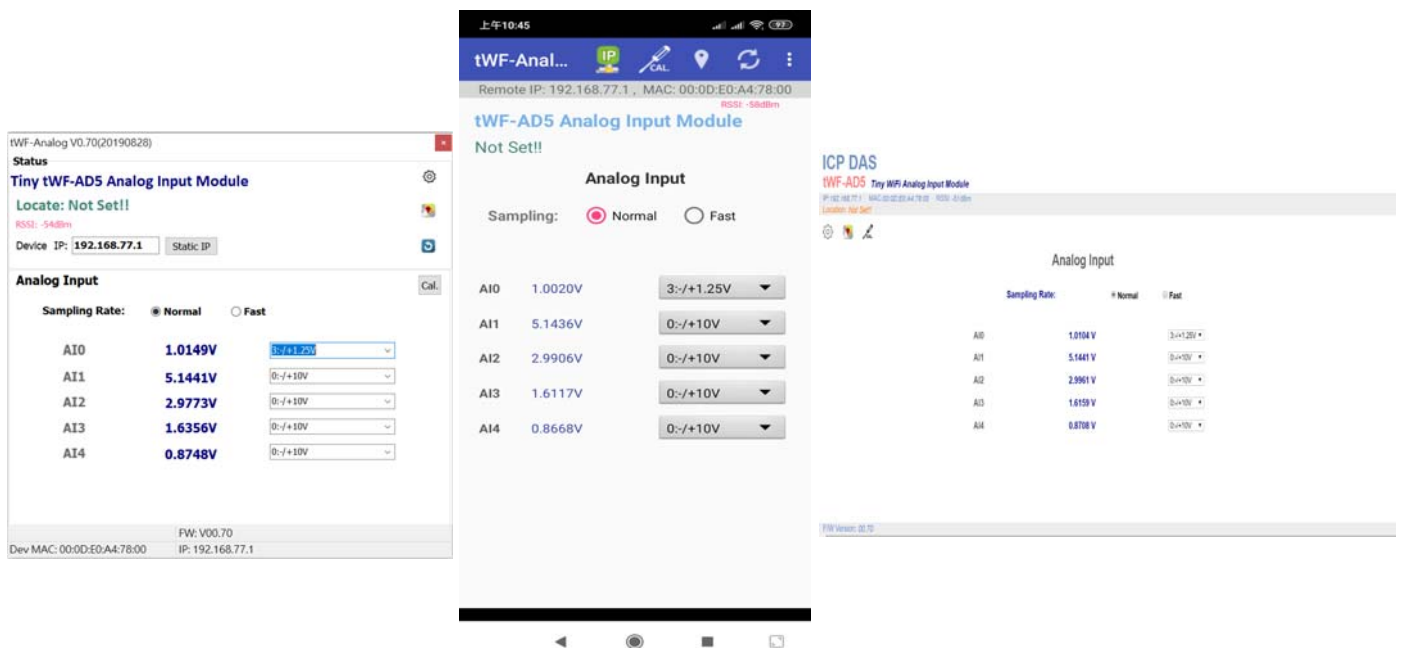

Figure 3-1: tWF Analog Utility main screen  
(From left to right is Windows Utility , Android App & Web browser)



# tWF-AD5 User's Manual

## 3.1.2.1 Module Status

Show the connected module information, user define Locate string, RSSI strength, Device IP & Static IP button for changing device IP in STA mode.

tWF-Analog V0.70(20190828) ✕

**Status**

**Tiny tWF-AD5 Analog Input Module**

**Locate: Not Set!!**

RSSI: -54dBm

Device IP:

## 3.1.2.2 Analog Status

Show the Analog input voltage readback, voltage range combo box “3:±1.25 V, 2:±2.5 V,1: ±5 V, 0:±10 V” setting & Sampling Rate Radio Button “Normal or Fast” setting.

**Analog Input** Cal.

Sampling Rate:  Normal  Fast

AI0	<b>1.0149V</b>	<input type="text" value="3:±1.25V"/>
AI1	<b>5.1441V</b>	<input type="text" value="0:±10V"/>
AI2	<b>2.9773V</b>	<input type="text" value="0:±10V"/>
AI3	<b>1.6356V</b>	<input type="text" value="0:±10V"/>
AI4	<b>0.8748V</b>	<input type="text" value="0:±10V"/>

### 3.1.2.3 Calibration

1. Click the “Cal.” Button on main screen, show the Analog Calibration form.
2. Click the channel which want to calibrate, show the Information dialog for confirm.
3. Follow the step in the dialog, connect the wire, after ready press “Yes”.
4. After finished it will show “Calibration Done!”

**(Device have been factory calibration before shipping)**

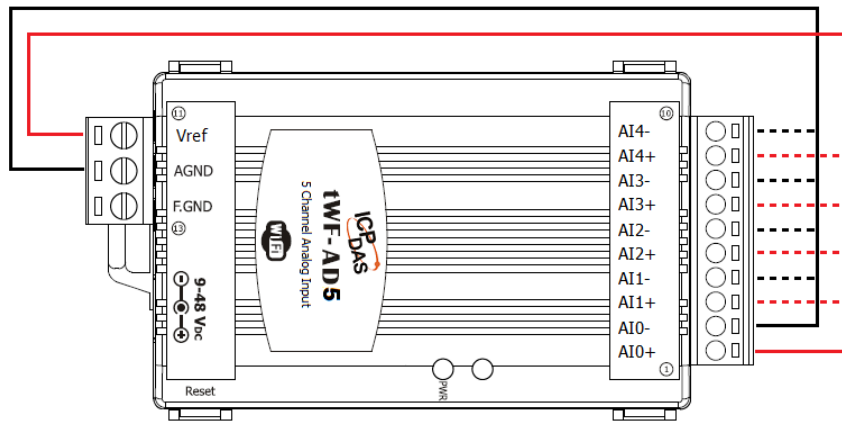
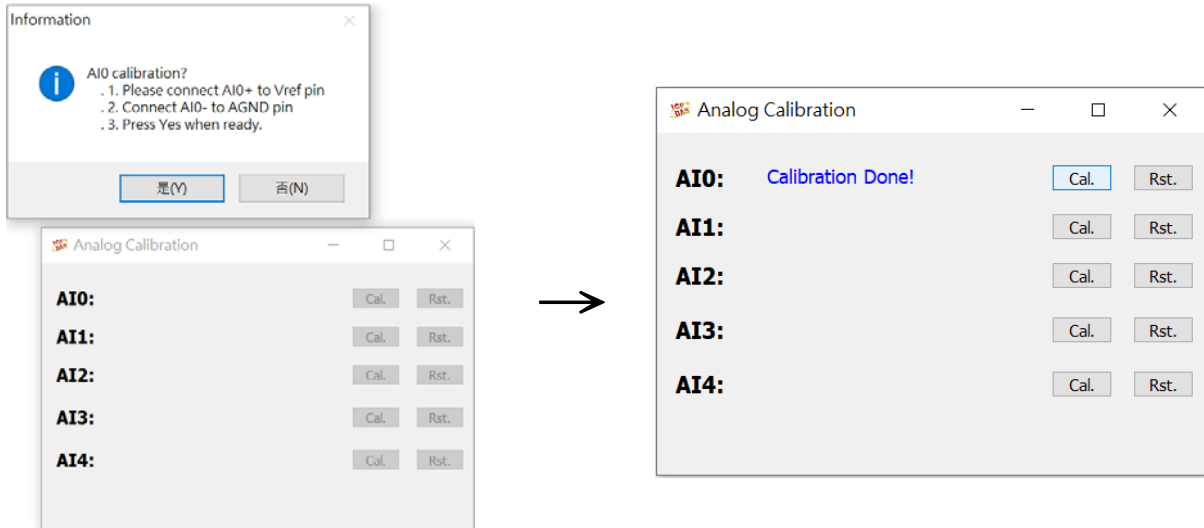
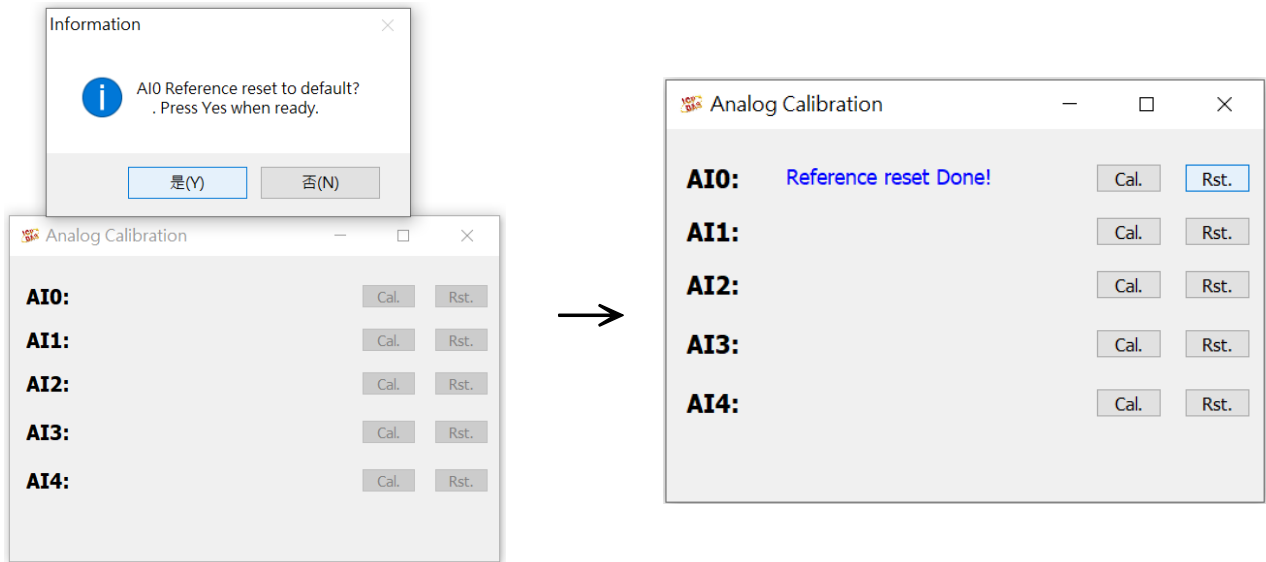

Figure 3-1: tWF-AD5 self-calibration wiring

For self-calibration, please use the Vref pin on the device, this pin has been calibration and save in factory.

### 3.1.2.4 Reference reset to factory default

1. Click the “Cal.” Button on main screen, show the Analog Calibration form.
2. Click the channel which want to reset, show the Information dialog for confirm.
3. Press “Yes” when ready.
4. After finished it will show “Reference reset Done!”



### 3.1.2.5 Status Bar

Show the F/W Version, Device's MAC address and Device's IP address.

	FW: V00.70
Dev MAC: 00:0D:E0:A4:78:00	IP: 192.168.77.1



## 3.1.2.6 ICON







ICON	function	
	<b>Setup</b>	Open the Setup page (Android versions Setup function under the  icon)
	<b>Find Module</b>	Red Led blinking, use to find the connected Module
	<b>Refresh</b>	Refresh status Web operating please use F5 or Refresh
	<b>Menu</b>	<b>Only Android Device</b> , Include setup, Function config, FW Version & About.
	<b>Calibration</b>	Show the Calibration page

Table 3-1: icon Indicator

## 3.1.3 Configuration/Setup

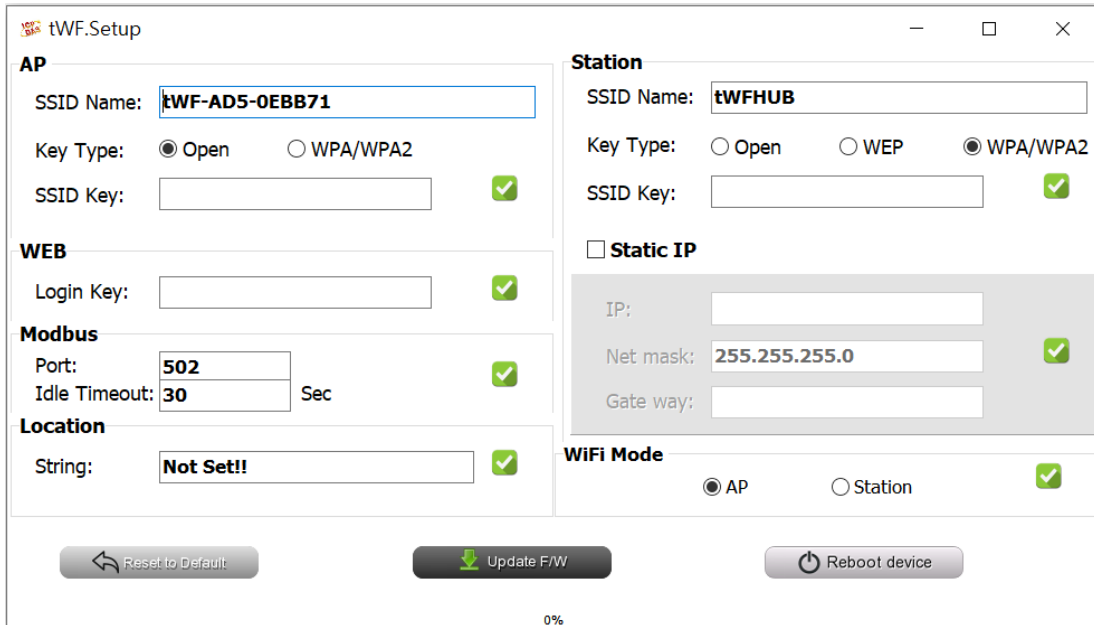

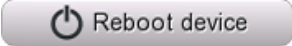

Figure 3-2: tWF Analog Utility setup page

Click apply icon  to save each subject's setting, after finishing all setting click  to make device take effect on new setting

### AP :

#### SSID Name

1. Module's SSID in Wi-Fi AP mode, (default will be tWF-[Module Name]-xxxxxx , show as below,
  - a. tWF-AD5-xxxxxx

Note: xxxxxx is the last 6 character MAC address of your device.

#### Key Type

AP mode SSID Key type,(default is **Open**)

#### SSID Key

AP mode SSID Key, (default is **None**)



# tWF-AD5 User's Manual

## STA :

### SSID Name

Wi-Fi AP's SSID intent to connect,(default is **tWFHUB**)

### Key Type

Wi-Fi AP's SSID Key Type,(default is **WPA/WPA2**)

### SSID Key

Wi-Fi AP's SSID Key,(default is **00000000**)

## Static IP:

**IP:** Specific an IP that is not been used.

**Mask:** Default will be **255.255.255.0**.

**Gateway:** Basically, define in the AP you are going to connect.

SSID	Service Set Identifier: Connected devices must be the same SSID, SSID length must not exceed 31 characters.
Key Type	Key of Encryption connected devices must with the same Key. Open : No Key request. WEP(Shared) : Key length must be 31 characters. WPA/WPA2-PSK : Key length must between 8~15 characters.

Table 3-2: Station SSID & Key type configure

## WiFi Mode :

tWF Module working mode, (default is in **AP**)

### AP (Access Point) :

PC or Android Device connect to tWF Module directly through AP(Fixed IP:**192.168.77.1**), AP mode support only one connection, If Multiple devices connect at a same time, only first connected devices can access.

### STA(Station):

tWF Module will auto connect to specific WiFi AP, PC or Android Device also need to connect to the same AP, then they can use those tWF Module in same domain.

**\*. Please check specific WiFi AP is active and SSID/key is same as the setting before use.**



# tWF-AD5 User's Manual

---

## WEB:

Open your Web Browser, fill the URL with the IP that been arrange to the device and enter. A while you will get a dialog for Account & Password, both Account & Password are “**admin**” for default.

- Modify Web password need 5 characters (max).
- In AP mode, the IP default will be **192.168.77.1**.
- In STA mode, use the IP scanner utility to discovery tWF device, found your device & enter the IP you intent to access.

## Location information:

Set the information for you to identify & locate those module easily, length must under 31 characters.

## Modbus Port:

Modify Modbus TCP Port (default is **502**)

## Modbus Idle Timeout:

Set Idle Timeout for Modbus TCP connection (default is **120 Sec**), recommend 30 Sec. when device in STA mode connect to an AP, Host device break connect with AP and lost connection, the device will hang in a dead connection. To prevent this happen, set a timeout, the device will close the connection and wait for next connect.

## 3.2 IP scanner

There are lot of Free IP scanner tools in both Windows & Android OS, for example “**Advanced IP Scanner**” for Windows, “**Network Analyzer**” for Android, those are high performance scanner tools on each OS.

## 4. Application

Users can use a Computer or Smart Device to communicate with the tWF devices in the application. It can complete the purpose of I/O control to wireless network by this way.



Figure 4-1: tWF + PC/Laptop/Smart Device application architecture

### 4.1 Connection with Modbus TCP utility

- Open Modbus TCP utility and key in the IP address , Port as "502". Finally, click the "Connect" button.
- If the network settings are correct, this will immediately establish a connection.
- Use the function code "0x06", and set the Reference Number as "0 0" as 0x0000, Register value "0 1" as 0x0001 to set the AI0 range to "1: ±5 V".
- 

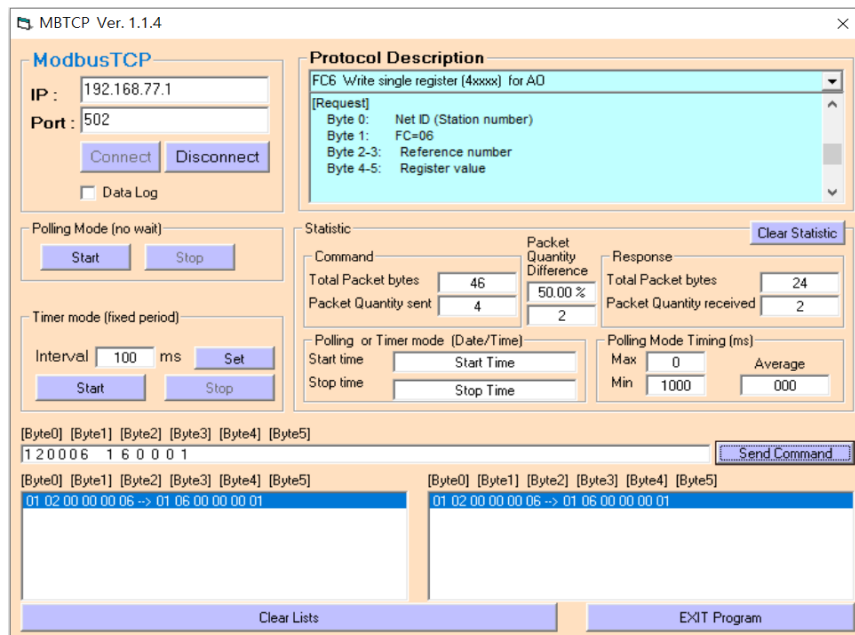

Figure 4-4: Set single AIx Input range

- e. Use the function code "0x03", and set the Reference Number "0 0" as 0x0000, word count "0 5" as 0x0005 to read the AI0~4 range value "00 01 00 00 00 02 00 00 00 03" as AI0 is "1: ±5 V", AI2 is "2: ±2.5 V", AI4 is "3: ±1.25 V" & AI1, AI3 is "0: ±10 V".

f.

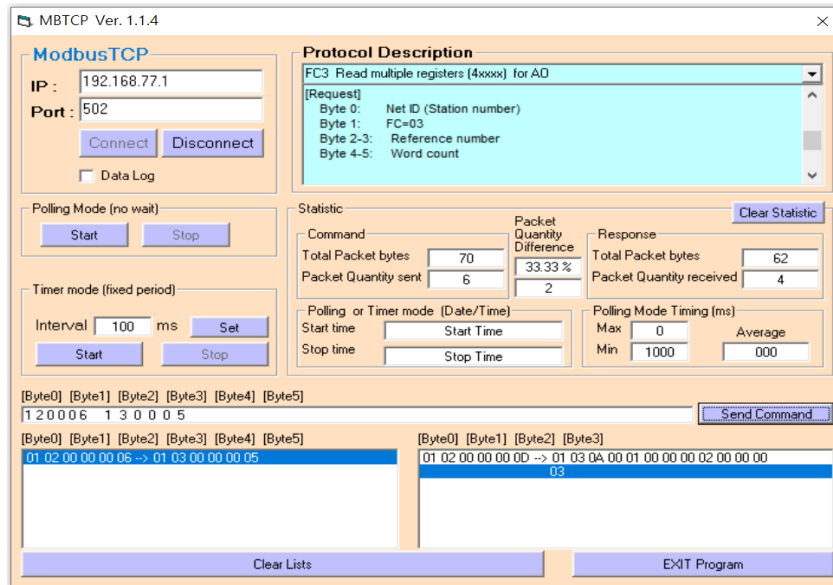

Figure 4-4: Read multiple AIx range setting

- g. Use the function code "0x04", and set the Reference Number "0 0" as "0x0000", word count "0 2" as "0x0002" to read back 2 channel, 2 word(4byte) AI0, AI1 Analog voltage value in mV, AI0 is "06 D5" as 0x06D5 = 1749mV, AI1 is "14 16" as 0x1416 = 5142mV.

h.

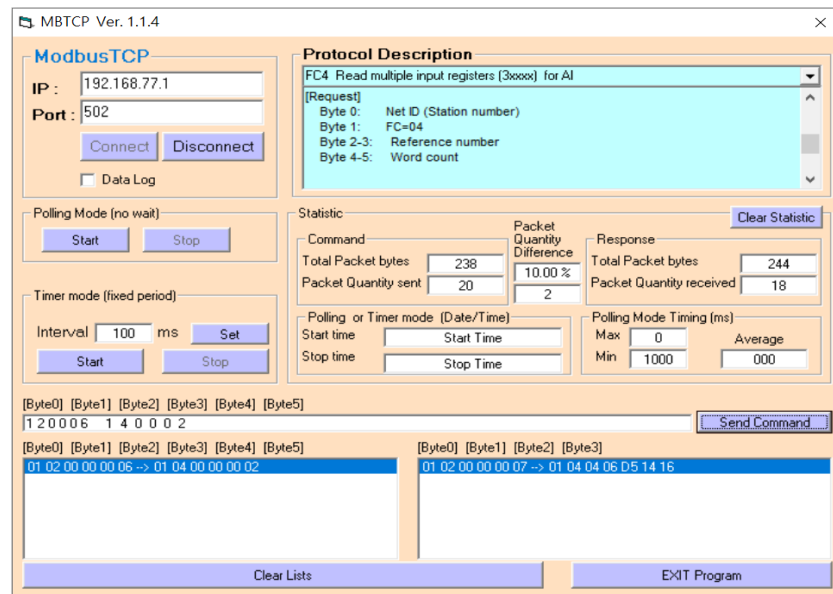

Figure 4-4: Read multiple AIx voltage(mV) value

- i. Use the function code "0x10", and set the Reference Number "0 0" as 0x0000, word count "0 5" as 0x0005, byte count "A" as 0x0A, Register value as "0 2" AI0 is "2: ±2.5 V", "0 1" AI1 is "1: ±5 V", "0 0" AI2 is "0: ±10 V", "0 2" AI3 is "2: ±2.5 V", "0 3" AI4 is "3: ±1.25 V".
- j.

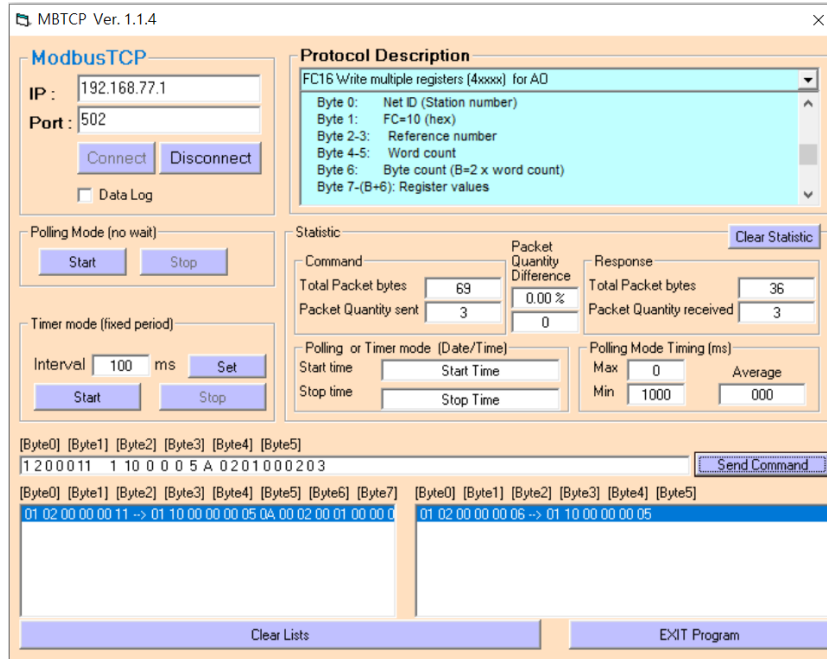

Figure 4-4: Set multiple AIx range

## 5. Modbus Applications

The tWF-AD5 include a Modbus port that allows you to access terminals data via Wi-Fi and communicates using a master-slave technique in which only one device (the master) can initiate transactions (called queries). The other devices (slaves) respond by supplying the requested data to the master, or by taking the action requested in the query.

Most SCADA (Supervisor Control And Data Acquisition) and HMI software can easily integrate serial devices via the Modbus protocol, such as Citect, ICONICS, iFIX, InduSoft, Intouch, Entivity Studio, Entivity Live, Entivity VLC, Trace Mode, Wizcon, Wonderware, etc.

For Android Device, a freeware HMI Modbus is easy to use.

### 5.1 What is Modbus TCP/IP?

Modbus is a communication protocol developed by Modicon in 1979.

Different versions of Modbus used today include Modbus RTU (based on serial communication like RS485 and RS232), Modbus ASCII and Modbus TCP, which is the Modbus RTU protocol embedded into TCP packets.

Modbus TCP is an internet protocol. The protocol embeds a Modbus frame into a TCP frame so that a connection oriented approach is obtained thereby making it reliable. The master query's the slave and the slave respond with the reply. The protocol is open and hence highly scalable.

### 5.2 Protocol Description

The Modbus protocol defines a simple protocol data unit independent of the underlying communication layers. The mapping of Modbus protocol on network can introduce some additional fields on the application data unit.

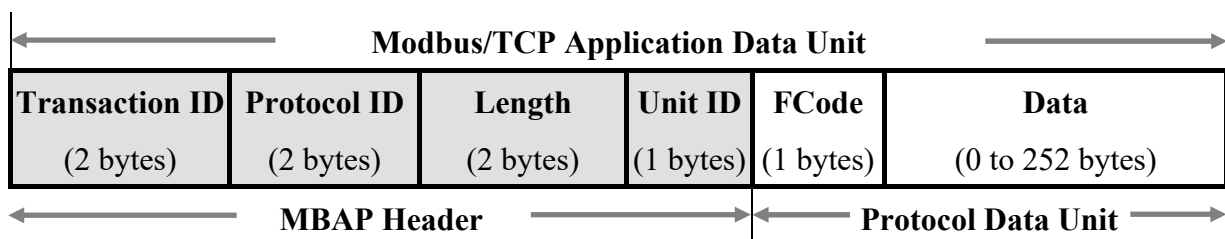

Figure 5-1: Modbus/TCP Application Data Unit





## 5.2.1 MBAP

The Modbus/TCP extension includes 7 additional bytes to the original Modbus protocol, which allows for transport over the TCP/IP layers.

A dedicated header is used on TCP/IP to identify the Modbus Application Data Unit. It is called the MBAP Header (MODBUS Application Protocol Header). The MBAP Header consists of 7 bytes of information:

Fields	Length	Description
Transaction Identifier	2 bytes	Identification of Request/Response transaction – Copied from request to response
Protocol Identifier	2 bytes	0 = Modbus protocol
Length	2 bytes	Number of following bytes - Includes the Unit Identifier
Unit Identifier	1 byte	Identification of remote slave

Table 5-1: MODBUS Application Protocol Header

## 5.2.2 Function Code

The function code field of a Modbus data unit is coded in one byte. Valid codes are in the range of 1 ... 255 decimal (the range 128 - 255 is reserved and used for exception responses). When a Modbus request is sent from a Modbus Client to a Server device the function code field tells the Server what kind of action to perform.

The Modbus/TCP feature of tWF-AD5 module supports 4 function codes, which allows the reading and writing of data contents of registers.

Function Code	Descriptions
01 (0x01)	Read Coil Status
02 (0x02)	Read Input Status
03 (0x03)	Read multiple AO Registers
04 (0x04)	Read AI Registers/Read counter
05 (0x05)	Write Single Coil/Clear Counter/Force Function mode
06 (0x06)	Write Single AO
16 (0x10)	Write multiple Coil/Registers/Force Function mode

Table 5-2: Supports Function Codes of tWF series



Any other function code request will be returned with an error response indicating the function code is not supported, as well as a request for too much data or data at a register address that not present.

## 5.2.3 Data

The data field of Modbus request sent from a client to server devices contains additional information that the server uses to take the action defined by the function code. This can include items like discrete and register addresses, the quantity of items to be handled, and the count of actual data bytes in the field.

The data field may be nonexistent (of zero length) in certain kinds of requests, in this case the server does not require any additional information. The function code alone specifies the action.

## 5.2.4 Response

If no error occurs related to the Modbus function requested in a properly received Modbus PDU (Protocol Data Unit) the data field of a Modbus response from a server to a client contains the data requested. If an error related to the Modbus function requested occurs, the field contains an exception code that the server application can use to determine the next action to be taken.

For example, a client can read the ON/OFF states of a group of digital input or output or it can read/write the data contents of a group of registers.

When the server responds to the client, it uses the function code field to indicate either a normal response or that error occurred (called an exception response). For a normal response, the server simply echoes to the request the original function code.

For an exception response, the server returns a code that is equivalent to the original function code from the request PDU with its most significant bit set to logic 1.

## 5.2.5 Data Encoding

Modbus uses a “big-endian” representation for address and data items. This means that when a numerical quantity larger than single byte is transmitted, the most significant byte (MSB, also called the high-order byte) is send first. The following sub-topics describe the different byte of encoding and show how the data is encoded as it is within the Modbus/TCP packet.

## 5.2.5.1 Binary

A binary item is represented as a single bit within a data word. All binary is packed into 16-bits data words, which are accessed using function code 01 and 02. Therefore, a single register contains 16 bits of binary data, each having a specific meaning.

Value	1st	2nd
0xAA55 (1010101001010101)	0xAA (10101010)	0x55 (01010101)

Table 5-3: A single register contains 16 bits of binary data

## 5.2.5.2 16-bits Word

A 16-bits word item is transmitted with the most significant byte first. Function code 03 and 04 read 16-bits items at a time; therefore, each of these data items will fit within one register that is read.

Value	1st	2nd
0x1234	0x12	0x34

Table 5-4: A 16-bits word item

## 5.2.5.3 32-bits Double Word

A 32-bits word item is transmitted with the most significant byte first. Function 04 read 32-bits items at a time; therefore, each of these data items will fit within 2 register that is read.

Value	1 <sup>st</sup> Word	2 <sup>nd</sup> Word
0x12345678	0x5678	0x1234

Table 5-5: A 32-bits double word item

## 5.3 Address Mapping

### 5.3.1 tWF-AD5 I/O Address Mapping

Address	CH	Descriptions	Range/Value	Access Type
40001~ 40005	5	AO output/AIx Range value	16bit Word	W

Table 5-8: FC10 Write multiple AO address (4xxxx)

Address	CH	Descriptions	Range/Value	Access Type
30001~30005	5	AIx Analog Voltage value(mV)	16bit Word	R

Table 5-9: FC04 Read multiple AI address (3xxxx)

Address	CH/Length	Descriptions	Range/Value	Access Type
40001~ 40005	5	AO output/AIx Range value	16bit Word	R
40011	Always 1	Read Idle Timeout value	16bit Word	R

Table 5-10: FC03 Read multiple AO address (4xxxx)

Address	CH	Descriptions	Range/Value	Access Type
40001~ 40005	5	AO output/AIx Range value	16bit Word	W
40011	-	Write Idle Timeout value	16bit Word(1~65000)	W

Table 5-11: FC06 Write Single AO address (4xxxx)

### Technical Support

If you have problems about using the tWF series module, please contact ICP DAS Product Support.

Email: [service@icpdas.com](mailto:service@icpdas.com)