



PET-7H24M

Ethernet High Speed Data Acquisition Module with
4 x AI, 2 x AO, 3 x DI, 4 x DO, 1 x Encoder Input

Features

- 4 differential Analog Input Channels (24-bit Resolution)
- Supports Real Sample and Hold
- 24-bit ADC with built-in Sinc3 filter
- Max. Sample Rate: 128 kS/s
- Built-in I/O
 - AI: 4 Channels
 - AO: 2 Channels
 - DI: 3 Channels
 - DO: 4 Channels
 - Encoder Input: 1 Channel



Introduction

The PET-7H24M is a high speed data acquisition devices with a built-in Ethernet communication port for data transfer over a network, and includes 4 high-speed 24-bit differential Analog input channels (128 kHz sample and hold for all 4 channels), 2 Analog Output channels, 3 Digital Input channels, 4 Digital Output channels and 1 Encoder Input channel. The module provides a programmable input range on all analog channels, and the Digital Output can be set to output with short-circuit and over load protection. 1 Encoder Input channel can be configured as Quadrant, Pulse/Direction or CW/CCW input mode. The PET-7H24M also provides 4 kV ESD protection as well as 2500 VDC intra-module isolation.

Acquisition	Trigger	Software AD	Analog Input
Continuous Mode		20 ~ 60 kHz	-
N Sample Mode		60 ~ 128 kHz	20 ~ 128 kHz

System Specifications

Communication	
Ethernet Port	1 x RJ-45, 10/100 Base-TX
PoE	Yes
Security	ID, Password and IP Filter
LED Indicators	
System Operation	Yes
Ethernet Link/Act	Yes
PoE Power	Yes
2-way Isolation	
Ethernet	1500 VDC
I/O	2500 VDC
EMS Protection	
ESD (IEC 61000-4-2)	4 kV Contact for each terminal and 8 kV Air for random Point
ESD (IEC 61000-4-4)	+/- 4 kV for power

Power	
Reverse Polarity Protection	Yes
Powered from Terminal Block	+12 ~ +48 VDC
Consumption	2.6 W
Mechanical	
Dimensions (W x L x H)	76 mm x 120 mm x 38 mm
Installation	DIN-Rail, Wall Mounting
Casing	Metal
Environmental	
Operating Temperature	-25 °C ~ +75 °C
Storage Temperature	-30 °C ~ +80 °C
Humidity	10 ~ 90 % RH, Non-condensing

I/O Specifications

Digital Input	
Channels	3
Contact	Wet Contact
Sink/Source (NPN/PNP)	Sink/Source
On Voltage Level	+5 ~ +30 VDC
Off Voltage Level	2 VDC Max.
Input Impedance	10 K Ohm
Isolation	2500 VDC
Digital Output	
Channels	4
Type	Isolated Open Collector
Sink/Source (NPN/PNP)	Sink
Load Voltage	+5 ~ +30 VDC
Load Current	100 mA at 25°C
Short-circuit Protection	Yes
Overload Protection	1.3 A
Isolation	2500 VDC

Pin Assignments

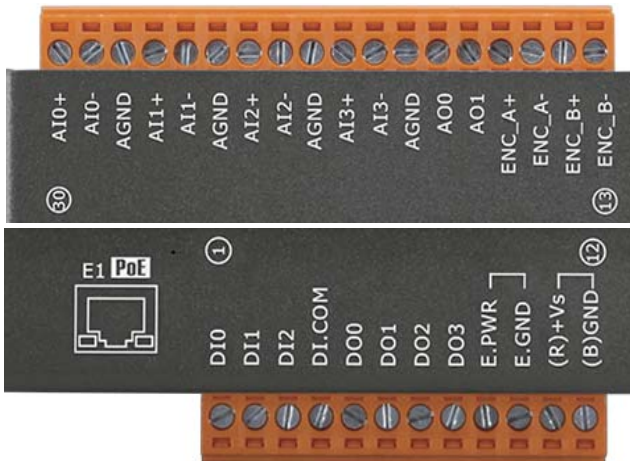

Analog Input	
Channels	4 differential Simultaneously
Resolution	24-bit
Sampling Rate	128 kS/s (Each Channel)
Bipolar Input (Programmable)	± 10 V, ± 5 V, ± 2.5 V, ± 1.25 V, ± 0.625 V, ± 300 mV, ± 150 mV, ± 75 mV, ± 40 mV, ± 20 mV
FIFO Size	4 k Samples
Accuracy	± 0.01 % of FSR @ ± 10 V; ± 0.02 % of FSR @ ± 5 V, ± 2.5 V; ± 0.02 % of FSR @ ± 1.25 V, ± 0.625 V; ± 0.1 % of FSR @ ± 300 mV, ± 150 mV; ± 0.1 % of FSR @ ± 75 mV, ± 40 mV; ± 0.2 % of FSR @ ± 20 mV
AD Trigger Mode (Programmable)	Software/Analog InputTrigger
Input Impedance	2 M Ohm
Analog Output	
Channels	2
Type	± 10 V, ± 5 V, 0 ~ 5 V, 0 ~ 10 V
Resolution	12-bit
Accuracy	± 0.01 % of FSR @ ± 10 V, ± 5 V, 0 ~ 10 V; ± 0.02 % of FSR @ 0 ~ 5 V
Output Capacity	10 V @ 20 mA
Slew Rate	0.83 V/us
Encoder Input	
Counter	32-bit
Encoder Mode	Quadrant /CW/ CCW and Pulse/Dir
Counting Rate	Quadrant Counting: 2 MHz (Max.) CW/CCW: 6 MHz (Max.) Pulse/Dir: 6 MHz (Max.)
On Voltage Level	+3.5 ~ +5 VDC
Off Voltage Level	+0.8 VDC Max.
Programmable digital filter	0.55 ~ 33.3 μ s (7 steps)
Isolation	2500 VDC

Dimensions (Units: mm)

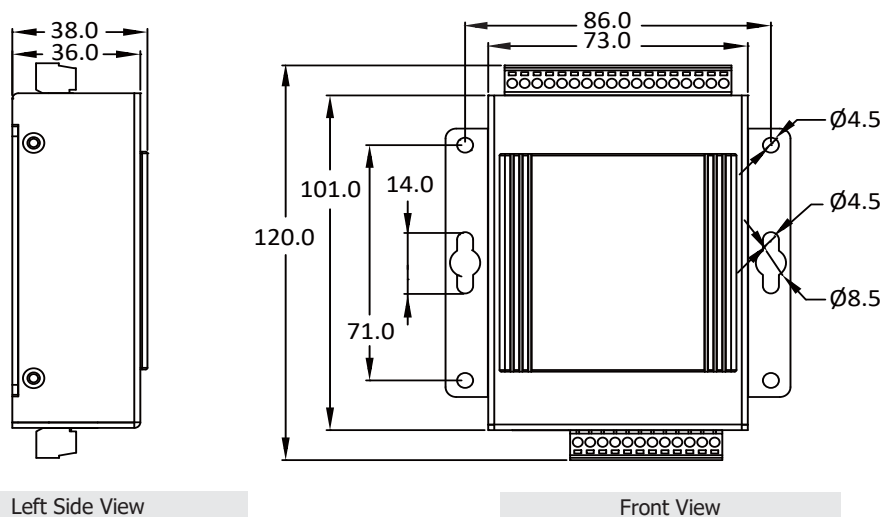

Wire Connections

1 Digital Input/Digital Output

Digital Input/Counter	ON State Readback as 1	OFF State Readback as 0
Wet Contact (Sink)		
Digital Output	ON State Readback as 1	OFF State Readback as 0
Open Collector (Sink)		

2 Analog Input/Analog Output

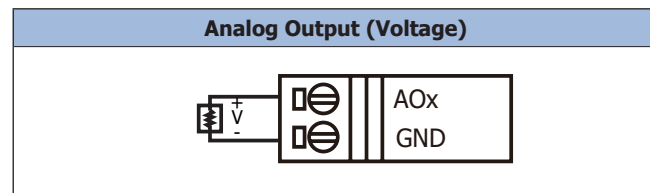
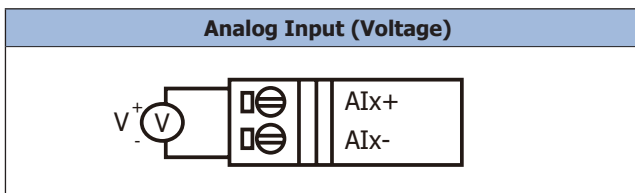

3 Encoder Input

Output Type	ON State Readback as 0	OFF State Readback as 1
Relay Contact	Relay ON 	Relay OFF
TTL/CMOS Logic	Voltage > 3.5 V Logic Power Logic Level High 	Voltage < 0.8 V Logic Power Logic Level Low
NPN Output	Open Collector ON 	Open Collector OFF
PNP Output	Open Collector ON 	Open Collector OFF

Features

1 Data transmission mode

1. Continuous transmission (Maximum sampling rate of 60 kHz per channel)

After starting A/D acquisition, data is continuously transmitted to the Host PC.

2. After collecting N data samples, the data is transferred to the Host PC (Maximum sampling rate of 128 kHz per channel)

(a) After starting A/D acquisition, the data will be temporarily stored in the memory on the PET-7H24M module, and wait until a command is received from the Host PC, before transferring the collected data to the Host PC.

(b) The memory capacity allows temporary storage of up to 1500 million data samples.



2 A/D trigger mode

Software AD Data Acquisition mode

The A/D acquisition parameters are configured via a command from the Host PC. The continuous A/D acquisition or the acquisition of N data samples begins after the command is triggered.

3 Analog Input Trigger

Analog Input Trigger is triggered when the voltage signal of the specified analog input channel is higher or lower than a certain voltage setting. In addition, the user can also specify the trigger voltage level range of the input signal. Once the signal leaves the high and low level region or the signal enters the high and low level region, it is triggered to start the acquisition.

1. Above High: The signal is triggered above the high level and collects N data.

2. Below Low: The signal is triggered below the low level and collects N data.

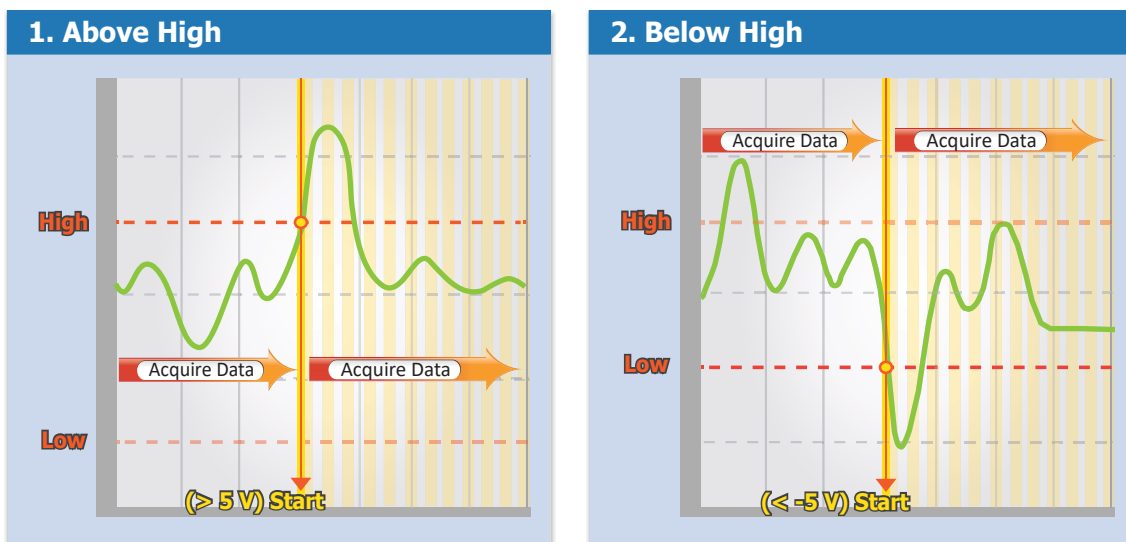

3. Leave-region: Trigger when the signal leaves the high and low level region, collect N data.

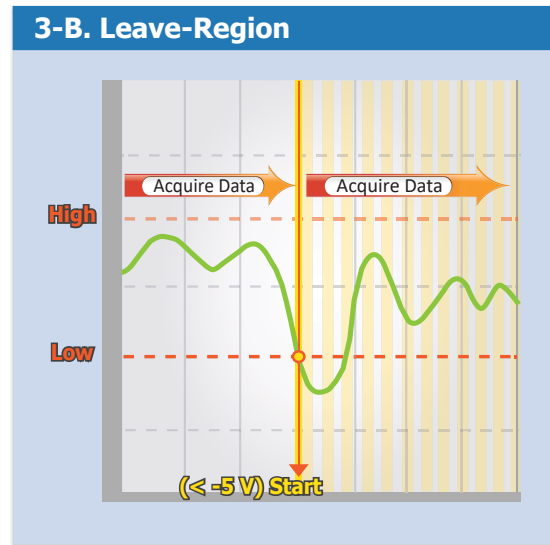
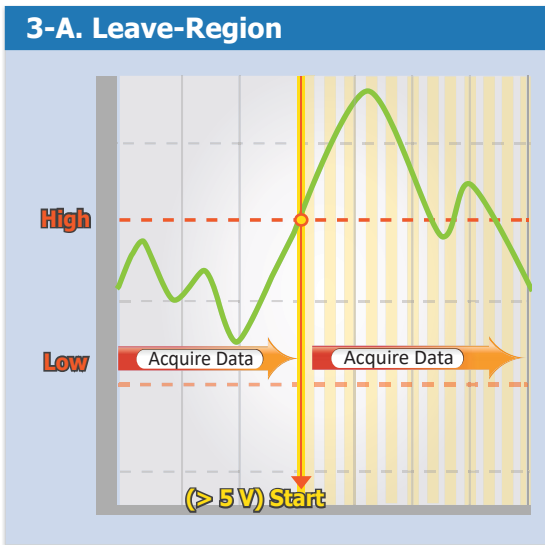

4. Entry-region: Trigger when the signal enters the high and low level region, collect N data.

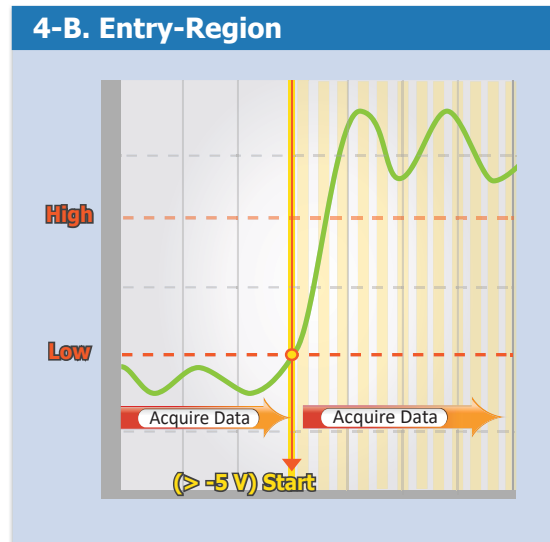
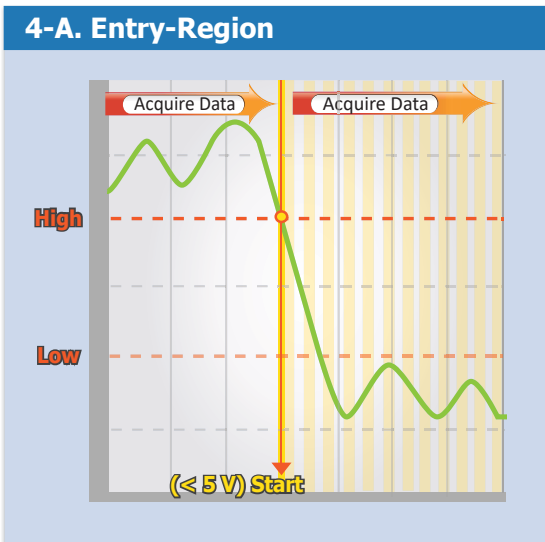

4 PC Software Support

1. Microsoft VC, C#, VB.NET SDK API and Demo for Windows.
2. LabVIEW Toolkit and Demo for Windows.
3. Library and Demo for Linux.

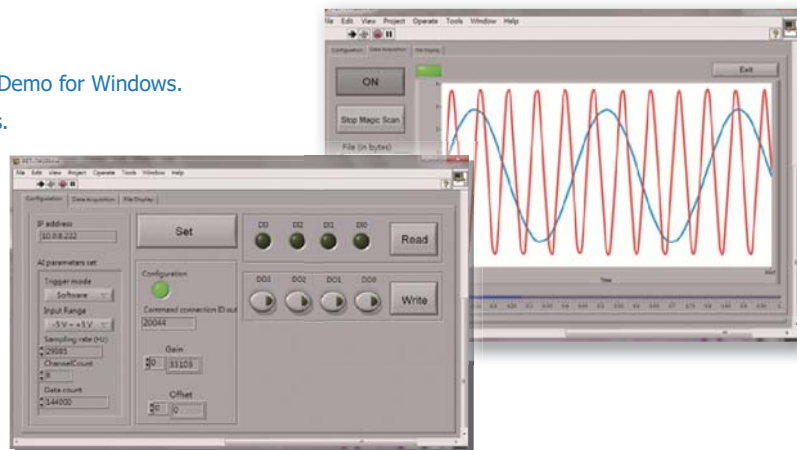

Ordering Information

PET-7H24M CR	Ethernet High Speed Data Acquisition Module with 4 x AI, 2 x AO, 3 x DI, 4 x DO, 1 x Encoder Channels (RoHS)
--------------	--