



***AXIOMTEK***

## **NA590 Series**

**SMB Network Appliance**

**User's Manual**



## **Disclaimers**

This manual has been carefully checked and believed to contain accurate information. Axiomtek Co., Ltd. assumes no responsibility for any infringements of patents or any third party's rights, and any liability arising from such use.

Axiomtek does not warrant or assume any legal liability or responsibility for the accuracy, completeness or usefulness of any information in this document. Axiomtek does not make any commitment to update the information in this manual.

Axiomtek reserves the right to change or revise this document and/or product at any time without notice.

No part of this document may be reproduced, stored in a retrieval system, or transmitted, in any form or by any means, electronic, mechanical, photocopying, recording, or otherwise, without the prior written permission of Axiomtek Co., Ltd.

## **CAUTION**

If you replace wrong batteries, it causes the danger of explosion. It is recommended by the manufacturer that you follow the manufacturer's instructions to only replace the same or equivalent type of battery, and dispose of used ones.

**©Copyright 2018 Axiomtek Co., Ltd.**

**All Rights Reserved**

**August 2018, Version A1**

**Printed in Taiwan**

## Safety Approvals

- ◆ CE Marking
- ◆ FCC Class A

### ◆ FCC Compliance

This equipment has been tested and complies with the limits for a Class A digital device, pursuant to Part 15 of the FCC Rules. These limits are designed to provide reasonable protection against harmful interference in a residential installation. If not installed and used in accordance with proper instructions, this equipment might generate or radiate radio frequency energy and cause harmful interference to radio communications. However, there is no guarantee that interference will not occur in a particular installation. If this equipment does cause harmful interference to radio or television reception, which can be determined by turning the equipment off and on, the user is encouraged to try to correct the interference by one or more of the following measures:

- Reorient or relocate the receiving antenna.
- Increase the separation between the equipment and receiver.
- Connect the equipment into an outlet on a circuit different from that to which the receiver is connected.
- Consult the dealer or an experienced radio/TV technician for help.
- Shielded interface cables must be used in order to comply with emission limits.

## Safety Precautions

Before getting started, read the following important cautions.

1. Be sure to ground yourself to prevent static charge when installing the internal components. Use a grounding wrist strap and place all electronic components in any static-shielded devices. Most electronic components are sensitive to static electrical charge.
2. Disconnect the power cords from the NA590 Series before making any installation. Be sure both the system and the external devices are turned OFF. Sudden surge of power could ruin sensitive components. Make sure the NA590 Series is properly grounded.
3. Do not open the system's top cover. If opening the cover for maintenance is a must, only a trained technician is allowed to do so. Integrated circuits on computer boards are sensitive to static electricity. To avoid damaging chips from electrostatic discharge, observe the following precautions:
  - Before handling a board or integrated circuit, touch an unpainted portion of the system unit chassis for a few seconds. This will help to discharge any static electricity on your body.
  - When handling boards and components, wear a wrist-grounding strap, available from most electronic component stores.

## Trademarks Acknowledgments

Axiomtek is a trademark of Axiomtek Co., Ltd.

Windows<sup>®</sup> is a trademark of Microsoft Corporation.

IBM, PC/AT, PS/2, VGA are trademarks of International Business Machines Corporation.

Intel<sup>®</sup> and Pentium<sup>®</sup> are trademarks of Intel Corporation.

AMI is trademark of American Megatrend Inc.

Other brand names and trademarks are the properties and registered brands of their respective owners.

# Table of Contents

---

Disclaimers.....	ii
Safety Approvals.....	iii
Safety Precautions.....	iv
<b>Chapter 1 Introduction .....</b>	<b>1</b>
1.1 General Description .....	1
1.2 Features .....	1
1.3 Specifications.....	2
1.4 Dimensions and Outlines .....	5
1.5 I/O Outlets .....	6
1.5.1 Front Panel.....	6
1.5.2 Rear Panel .....	8
<b>Chapter 2 Hardware and Installation .....</b>	<b>9</b>
2.1 Check List.....	9
2.2 Board Layout .....	10
2.3 Jumper Settings .....	12
2.3.1 CMOS Clear Jumper (JP3) .....	13
2.3.2 LAN Bypass Control Selection Jumper (JP6, JP7, JP8).....	13
2.3.3 TACT SW1 Function Selection Jumper (JP10) .....	14
2.3.4 Auto Power Button Model Jumper (JP12).....	14
2.4 Connectors .....	15
2.4.1 ATX Power Connector (CN2) .....	16
2.4.2 Mini Card Connector for mSATA (CN3).....	17
2.4.3 LCM Connector (CN4) .....	18
2.4.4 1X2 SFP Connector for optional (CN5).....	18
2.4.5 1X2 RJ45 Connector(CN6~CN10).....	19
2.4.6 Console & USB3.0 Port0 ~ Port1 Connector (CN11).....	19
2.4.7 ATX +12V CPU Power Connector (ATX1) .....	19
2.4.8 USB Port Connectors (USB1~2) .....	20
2.4.9 FAN Connectors (FAN1~3) .....	20
2.4.10 Serial Port 2 Connector (COM2) .....	20
2.4.11 Serial ATA Connectors (SATA1.2.3.4) .....	21
2.4.12 Front Panel Bezel Connector (JP5) .....	21
2.4.13 VGA Connector (VGA1) .....	22
2.4.14 Digital I/O Port Connector (DIO1) .....	22
2.5 Hardware Installation .....	23

2.5.1	Installing the CPU.....	23
2.5.2	Installing the Memory .....	26
2.5.3	Installing the Hard Disks.....	27
<b>Chapter 3</b>	<b>AMI BIOS Setup Utility.....</b>	<b>29</b>
3.1	Starting.....	29
3.2	Navigation Keys .....	29
3.3	Main Menu.....	30
3.4	Advanced Menu.....	31
3.5	Chipset Menu.....	46
3.6	Security Menu.....	50
3.7	Boot Menu.....	51
3.8	Save & Exit Menu .....	52
<b>Appendix A</b>	<b>LAN Bypass Configuration.....</b>	<b>57</b>
	About LAN Bypass.....	57
	LAN Bypass Register Configuration .....	58
<b>Appendix B</b>	<b>WDT Timer for System Reset.....</b>	<b>61</b>
<b>Appendix C</b>	<b>LAN Module Expansion .....</b>	<b>63</b>
	LAN Bypass Control Jumper (JP2/JP3) .....	63
<b>Appendix D</b>	<b>Warning .....</b>	<b>71</b>

# Chapter 1

## Introduction

This chapter contains general information and detailed specifications of the NA590 Series Network Appliance Server. It contains the following sections:

- General Description
- Features
- Specifications
- Dimensions and Outlines
- I/O Outlets

### 1.1 General Description

The NA590 is a 1U rackmount network appliance based on Intel® Xeon E3/ the 8<sup>th</sup> Generation Core i Processors with Intel® C246 / H310 Chipset (Coffee lake), The appliance sets the target at greatly improved CPU performance and reduced power consumption based on Intel's new architecture. It provides greater performance and power efficiency to equipment providers.

For greater flexibility, the NA590 has two front-accessible expansion slots that allow developers to expand two different LAN modules based on their solution requirements. This expansions need to be requested before production. The two expandable LAN modules via the PCIe 3.0 interface, support max up to 26 LAN ports. To avoid the influences of shutdown by the environment, the NA590's motherboard supports data protection via 2 pairs of latch-type LAN bypass for fail-over option.

For storing event log data, the NA590 utilizes two 2.5" SATA HDDs or one 3.5" SATA HDD(optional). And NA590 supports four dual channel up to 64GB DDR4-2400 non-ECC/ECC memory and one standard PCIe x8 expansion slot for optional network security card.

The NA590 is designed for network enterprise business. NA590 not only provides high performance processor, memory, storage interface and LAN connection, but also includes outstanding management capability.

### 1.2 Features

- LGA 1151 Intel® Coffee Lake-S Xeon® Processor E Family and 8th Core i7/i5/i3 processors
- Two UDIMM sockets for H310 chipset, up to 32GB none-buffer none-ECC (DDR4 2400)  
Four UDIMM sockets for C246 chipset, up to 64GB none-buffer none-ECC / ECC memory (DDR4 2400)
- Supports two LAN modules expansion (NA590 optional)
- Supports BIOS redirected to COM port
- Supports two 2.5" SATA HDDs or one 3.5" SATA HDD (optional)
- Suitable for VPN, network bandwidth controller, firewall applications

## 1.3 Specifications

### System

- **System CPU**
  - LGA1151 Intel® Coffee Lake-S Xeon® Processor E Family and 8th Core i7/i5/i3 processors
  
- **System Chipset**
  - Intel® C246 / H310
  
- **System Memory**
  - NA590 (PCH: C246): 4 x DDR4 2400 DIMM sockets, up to 64GB none-buffer none-ECC / ECC memory
  - NA590 (PCH: H310): 2 x DDR4 2400 DIMM sockets, up to 32GB none-buffer none-ECC memory
  
- **BIOS**
  - AMI 256Mbit PnP Flash BIOS with function of BIOS redirected to COM port
  
- **Storage**
  - Two 2.5" SATA HDDs or one 3.5" SATA HDD (optional)
  - One mSATA
  
- **LAN**
  - The default is 8 x 10/100/1000Mbps LAN ports and 2 pairs LAN bypass(C246)
  - The default is 6 x 10/100/1000Mbps LAN ports and 2 pairs LAN bypass(H310)NA590: Expandable up to 26 LAN ports via LAN modules.



**Note:** On board LAN Bypass feature for LAN 3/LAN4 and LAN5/LAN6 , Lan 9 & Lan10 Colay fiber for optional (C246 only)



- **LAN Modules**

Slim Module	Ports	Chipset	Bypass	NA590
<b>GbE Copper Modules</b>				
AX93316-8GI	8	Intel 82580EB	0	v
AX93316-8GIL	8	Intel 82580EB	4	v
AX93326-8GIL	8	Intel 210AT	4	v
AX93336-4GI	4	Intel i211AT	0	v
AX93336-4GIL	4	Intel i350	2	v
<b>GbE Fiber Modules</b>				
AX93322-8FI	8	Intel 82580EB	0	v
AX93322-8MIL	4+4	Intel 82580EB	2	v
AX93336-4FI	4	Intel i350	0	v
<b>10GbE Copper Modules</b>				
AX93317-2GIL	2	Intel X540	1	v
<b>10GbE Fiber Modules</b>				
AX93307-2FI	2	Intel 82599ES	0	v
AX93307-2FIL	2	Intel 82599ES	1	v
AX93327-4FI	4	Intel XL710	0	v
<b>25GbE Fiber Modules</b>				
AX93332-25FI	2	Intel XXV710	0	V
<b>40GbE Fiber Modules</b>				
AX93331-2QFI	2	Intel XL710	0	V

- **Super I/O**

- Controller: Winbond NCT6102D
- Serial Ports: Total 2 asynchronous ports (2 x RS-232; one is 10-pin header onboard but RX/TX signal is co-lay used for LCM module connector, the other one is RJ-type connector with Cisco define)

- **I/O Interface**

- One console RJ-type connector, 2 x USB 3.0 connectors and 8 x RJ-45 connectors (default) or up to 26 LAN ports (expandable).
- LED: 1x4 LED for LAN bypass 1~2, Power and HDD  
1x2 LED for GPO 1~2
- 2 x LAN modules (optional)
- Tact switch x2 (up : GPI button) \ (down: hardware system reset button)

- **Watchdog Timer**

- One for System Reset: 255 levels, 1-255 sec
- One for LAN bypass: 7 levels, 1-64 sec

- **USB**

- Two USB 3.0 ports one front side, four USB 2.0 are internal pin headers

- **Hardware Monitoring**

- Controller Winbond NCT6102D
- CPU temperature, system temperature, power and fan speed detection

- **Expansion Slot**

- NA590(C246) support two LAN modules through AX98621 with two front slots or support one module & one PCIe8 slot through AX98621 with one front slot & AX96708 Riser card.
- NA590(H310) support one LAN modules through AX98621

- **Power Supply**
  - 300W single power supply
  - 300W redundant power supply (1+1) (optional)



**Note:**



*Indicates to unplug all AC power cord(s) to disconnect AC Power*

- **OS Compatibility**
  - Linux kernel 4.14 above

## Mechanical/Environmental

- **Form Factor**
  - 1U rackmount
- **Operation Temperature**
  - 0°C ~ 45°C
- **Storage Temperature**
  - -20°C ~ 70°C
- **Humidity**
  - 10% - 95% RH, non-condensing
- **Chassis Material**
  - Steel
- **Dimensions**
  - 44mm (1.73") (H) x 430mm (16.84") (W) x 450mm (20.59") (D)
- **Certificate**
  - FCC class A / CE class A



**Note:** *All specifications and images are subject to change without notice.*

## 1.4 Dimensions and Outlines

The following diagram shows you dimensions and outlines of the NA590 Series.

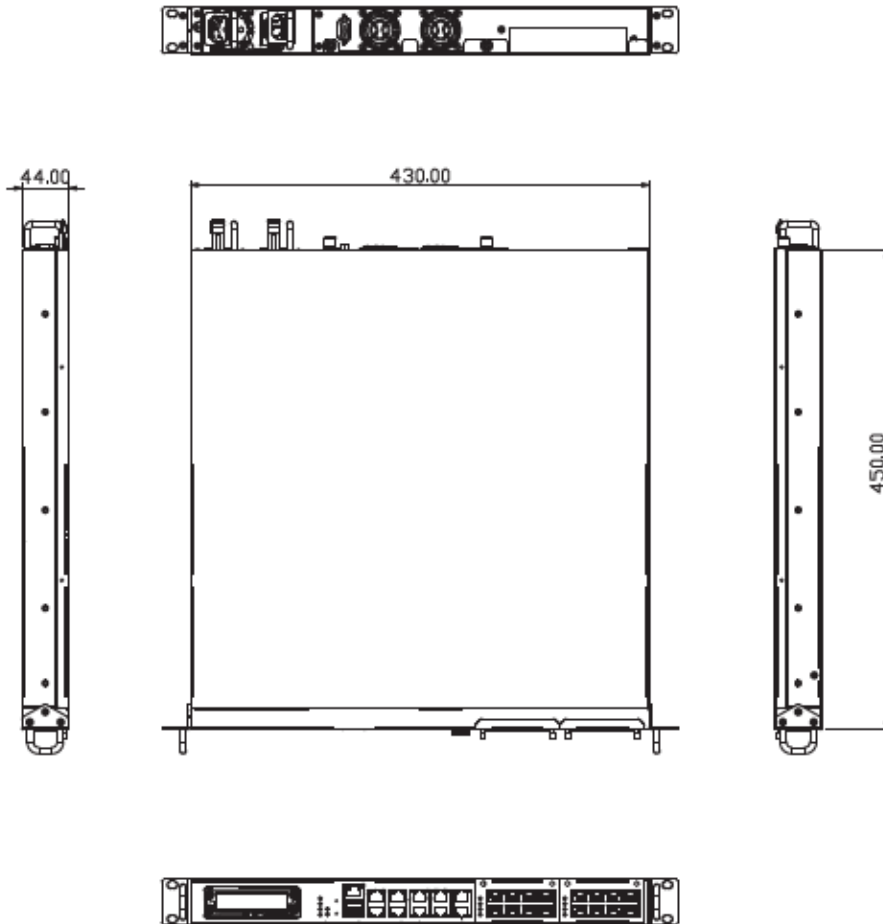

**Default: 8 LAN ports max up to 26 LAN ports**

## 1.5 I/O Outlets

Locate front and rear panel I/O outlets on the NA590 Series server to connect serial and ethernet interface devices.

### 1.5.1 Front Panel

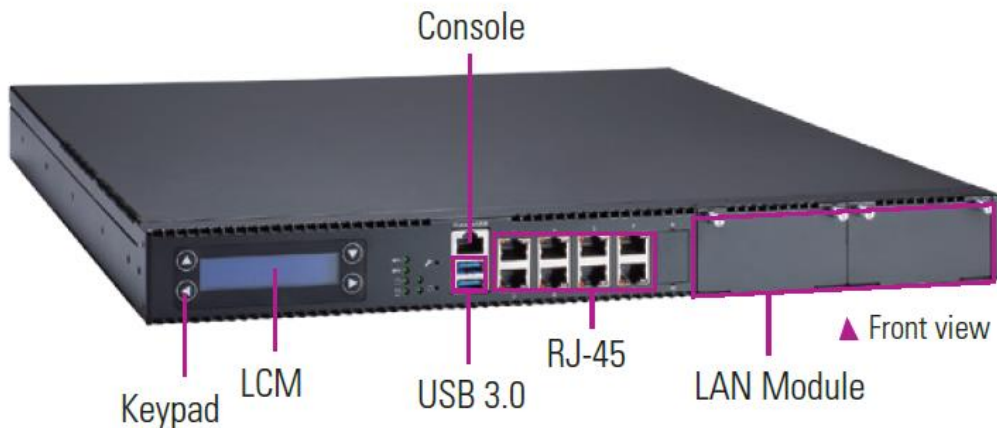

- **Power LED (Green)**  
LED light up when the server is powered on to perform diagnostic tests and proper operation checking.
- **HDD LED (Green)**  
LED flashes when HDD is transmitting or receiving data.
- **Programmable LED GPIO1, GPIO2 (Green)**  
The GPIO1 and GPIO2 LEDs are controlled by programmable GPIO. A sample code will be provided that allow users to define their own function.
- **“Default” Tact Switch**  
The sample code will be provided that allows users to define their own function. For example, when the system has any problems, this switch can support to reset it to the customer's OS default settings if our customer's OS supports this application.
- **“Reset” Tact Switch**  
It is for reset the system to reboot your computer instead of turning OFF the power switch. It is a better way to reboot your system for a longer life of the system's power supply.
- **Console Port**  
This is a Cisco RJ-type connector console port for command line interface and diagnostic support by P.O.S.T (Power On Self Test).
- **USB3.0 Ports**  
Two USB 3.0 ports supported.
- **LAN bypass LED(BP1/BP2)**  
While running the LAN By-Pass function, the LED always lights up.

- **Transfer Rate for LAN port**

The double-color LED light indicates 10/100/1000Mbps transfer rate.

LED Light Color	Transfer Rate
Dark	10Mbps
Green	100Mbps
Orange	1000Mbps

- If the LED is dark and Active/Link LED is lighting on flashing, the transfer rate should be 10Mbps.
- When the green-color LED light is radiating, the transfer rate should be 100Mbps.
- When the orange-color LED light is radiating, the transfer rate should be 1000Mbps.
- When this LED and Link/Active LED both are dark, no networking devices are attached.

- **Active/Link LED for LAN Port**

- The orange LED is on when the LAN port connection is working.
- The LED flashes when transmitting or receiving any signals to or from the appliance.
- The LED is dark when the appliance is off.



**Note:** *Optional LAN module LED definition in Appendix C.*

## 1.5.2 Rear Panel

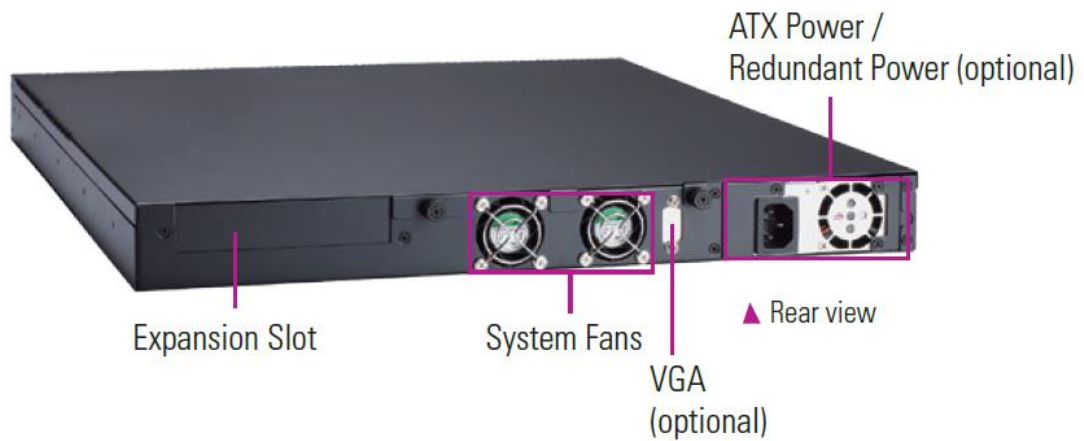

- **Power Supply**  
System power use power cord to connect the power supply to electrical outlet (AC).
- **System Fans**  
These are fans for cooling down system temperature.

# Chapter 2

## Hardware and Installation

The NA590 Series are convenient for your various hardware configurations. This chapter will help you get familiar with the hardware.

### 2.1 Check List

The package bundled with your NA590 Series should contain the following items:

- **The NA590 Series network appliance hardware platform**
- **Power cord x 1**
- **Mounting brackets for rack installation (left/right) x 2**
- **Plastic stand for stack-up x 4**
- **Mounting screws for disk drive and additional screws for this appliance's spare parts**
- **SATA cable x 2 for 2.5" SATA HDDs**

If you can not find this package or any items are missing, please contact Axiomtek distributors immediately. If you order any optional components, the package might contain those additional hardware or documents accordingly.

## 2.2 Board Layout

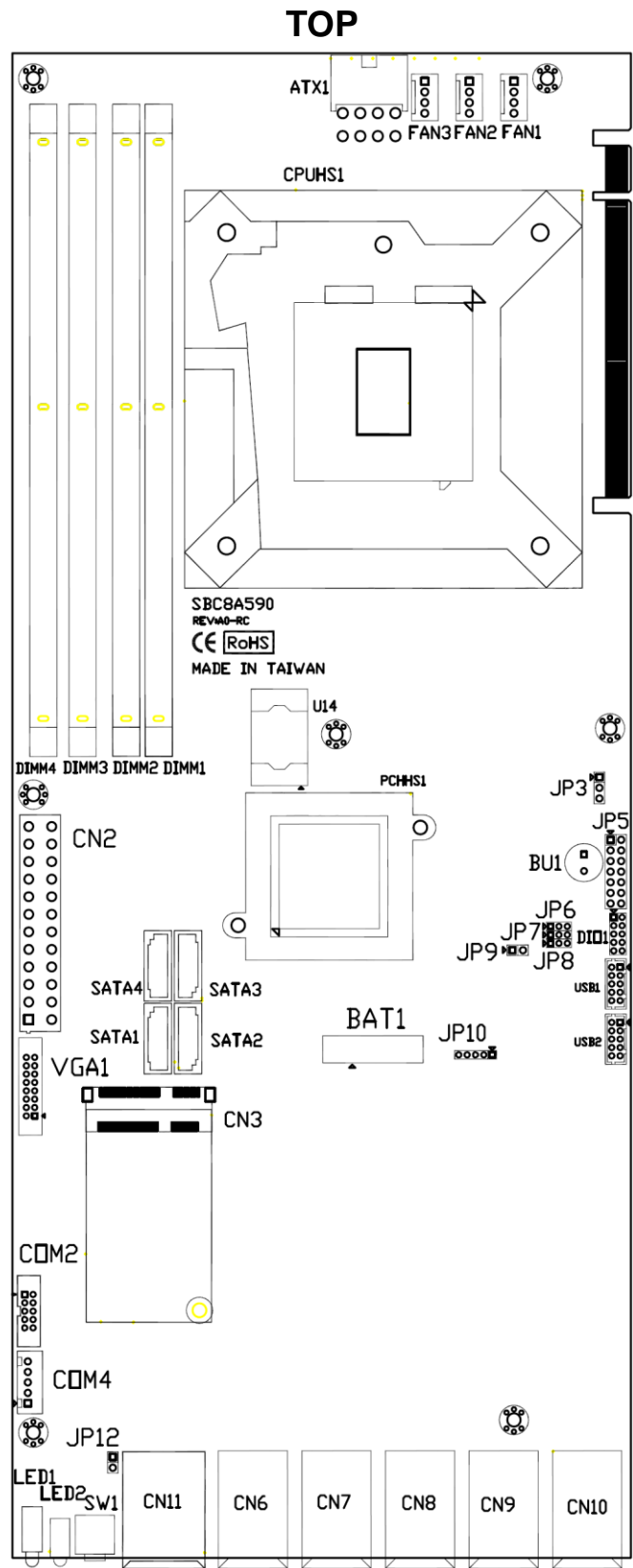



# BOTTOM



## 2.3 Jumper Settings

Jumper is a small component consists of jumper clip and jumper pins. Install jumper clip on 2 jumper pins to close. And remove jumper clip from 2 jumper pins to open. Below illustration shows how to set up jumper.

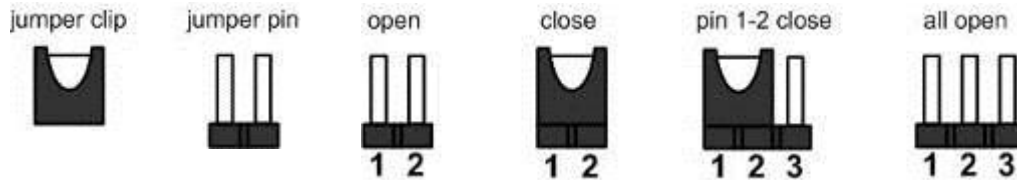



This section provides the information about jumpers and connectors of NA590 Series. Properly configure jumper settings on the main board in this appliance to meet your application purpose. Below we list a summary table of all jumpers and default settings for onboard devices.









Jumper	Definition	Jumper Setting
JP1	reserve	No Jumper : Normal (default)
JP3	Clear CMOS Setting	1-2 : Normal (Default) 2-3 : Clear CMOS
JP6 JP7 JP8	LAN Bypass Trigger When Power On	(1-2)/(1-2)/(1-2) : Mother board/SEGN1 ~2 Bypass as same as Power Off status (1-2)/(1-2)/(2-3) : Mother board/SEGN1~2 Bypass Disable(Default) (1-2)/(2-3)/(2-3) : Mother board/SEGN1 ~2 Bypass Enable
JP9	Case Open Setting	1-2 : case open No Jumper : Normal (default)
JP10	TACT SW1 Selection	1-2 : Power button On/Off 2-3 : Reset (Default) 4-5 : GPI
JP11	reserve	No Jumper : Normal (default)
JP12	Auto Power Button Mode Selection	1-2 : Always Power Off No Jumper : Always Power On (Default)

### 2.3.1 CMOS Clear Jumper (JP3)

Use this jumper to erase and restore CMOS memory and BIOS setting. Put jumper clip to pin 2-3 for a few seconds then move it back to pin 1-2. By doing this procedure CMOS data resets to its safe default settings.



Description	Function	Jumper Setting
COMS Clear	Normal (Default)	 JP3 3 2 1
	Clear CMOS	 JP3 3 2 1

### 2.3.2 LAN Bypass Control Selection Jumper (JP6, JP7, JP8)

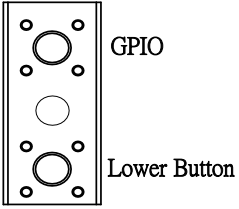
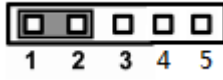

Description	Function	Jumper Setting
LAN Bypass Trigger when Power On	Mother board/SEGN1 ~2 Bypass as same as Power Off status	 JP6 1 2 3  JP7 1 2 3  JP8 1 2 3
	Mother board/SEGN1 ~2 Bypass Disable(Default)	 JP6 1 2 3  JP7 1 2 3  JP8 1 2 3
	Mother board/SEGN1 ~2 Bypass Enable	 JP6 1 2 3  JP7 1 2 3  JP8 1 2 3

 **Note:** When the system is turned on, you can select LAN bypass function by Jumper and Bios when power on state, when enter the OS, you can select LAN bypass function at power on/ off state by software.

### 2.3.3 TACT SW1 Function Selection Jumper (JP10)

Description	Function	Jumper Setting
<p>TACT SW1 Function Selection</p>  <p>GPIO</p> <p>Lower Button</p>	Power On/Off	<p>JP10</p> 
	Reset (Default)	<p>JP10</p> 
	GPI	<p>JP10</p> 

### 2.3.4 Auto Power Button Model Jumper (JP12)

Description	Function	Jumper Setting
Auto Power Button Mode Selection	Always Power Off ATX Mode	<p>JP12</p> 
	Always Power On (Default)	<p>JP12</p> 

## 2.4 Connectors

Signals go to other parts of the system through connectors. Loose or improper connection might cause problems, please make sure all connectors are properly and firmly connected. Here is a summary table which shows all connectors on the hardware.

Connectors	Label
ATX Power Connector	CN2
Mini Card Connector for mSATA	CN3
LCM Connector	CN4
1X2 SFP Connector (optional)	CN5
1X2 RJ45 Connector (C246:CN6~9),(H310:CN6~8), CN10 for optional	CN6~CN10
Serial Port1 (For Console) & USB3.0 Port0 ~ Port1 Connector	CN11
ATX +12V CPU Power Connector	ATX1
PMBUS connector	PMBUS1
USB Port Connectors	USB1~2
FAN Connector	FAN1~3
Serial Port2 Connector	COM2
Serial ATA Connector	SATA1~4
Front Panel Bezel Connector	JP5
VGA Connector	VGA1
DDR4 DIMM Socket(Channel A DIMM0 )	DIMM1
DDR4 DIMM Socket(Channel A DIMM1 )	DIMM2
DDR4 DIMM Socket(Channel B DIMM0 )	DIMM3
DDR4 DIMM Socket (Channel B DIMM1 )	DIMM4
GPIO Connector (reserved)	DIO1
Battery Connector	BAT1

### 2.4.1 ATX Power Connector (CN2)

Steady and sufficient power can be supplied to all components on the board by connecting the power connector. Please make sure all components and devices are properly installed before connecting the power connector.

Pin	Signal	Pin	Signal
1	+3.3V	2	+3.3V
3	Ground (GND)	4	+5V
5	Ground (GND)	6	+5V
7	Ground (GND)	8	PWR_OK
9	5VSB	10	+12V
11	+12V	12	+3.3V
13	+3.3V	14	-12V
15	Ground (GND)	16	PS_ON
17	Ground (GND)	18	Ground (GND)
19	Ground (GND)	20	-12V
21	+5V	22	+5V
23	+5V	24	Ground (GND)

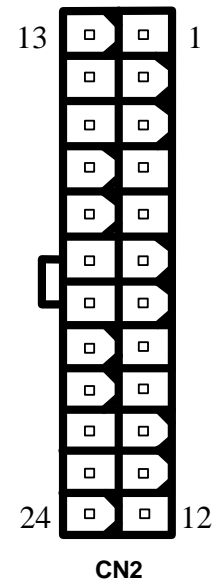

## 2.4.2 Mini Card Connector for mSATA (CN3)

This is a 52-pin connector which is commonly used for SATA & USB signal

Pin	Signal	Pin	Signal
1	No use	2	+3.3VSB
3	No use	4	Ground (GND)
5	No use	6	+1.5V
7	No use	8	No use
9	Ground (GND)	10	No use
11	No use	12	No use
13	No use	14	No use
15	Ground (GND)	16	No use
17	No use	18	Ground (GND)
19	No use	20	+3.3VSB
21	Ground (GND)	22	PERST#
23	SATA0_RXP	24	+3.3VSB
25	SATA0_RXN	26	Ground (GND)
27	Ground (GND)	28	+1.5V
29	Ground (GND)	30	SMB_CLK
31	SATA0_TXN	32	SMB_DATA
33	SATA0_TXP	34	Ground (GND)
35	Ground (GND)	36	USB_D-
37	Ground (GND)	38	USB_D+
39	+3.3VSB	40	Ground (GND)
41	+3.3VSB	42	No use
43	Ground (GND)	44	No use
45	No use	46	No use
47	No use	48	+1.5V
49	No use	50	Ground (GND)
51	No use	52	+3.3VSB

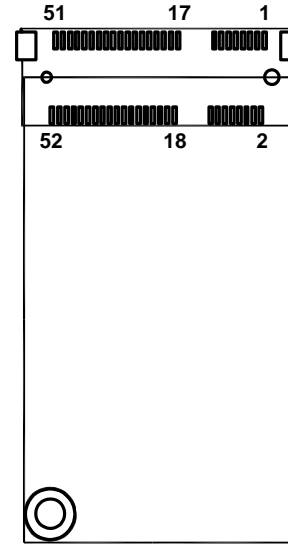

CN3

### 2.4.3 LCM Connector (CN4)

This is a 5-pin connector for LCM.

Pin	Signal
1	+5V
2	RX (colay COM2)
3	N.C
4	TX (colay COM2)
5	GND



### 2.4.4 1X2 SFP Connector for optional (CN5)

Pin	Signal	Pin	Signal
T1	Ground (GND)	L1	Ground (GND)
T2	TX_Fault	L2	TX_Fault
T3	TX_Disable	L3	TX_Disable
T4	SDA	L4	SDA
T5	SCL	L5	SCL
T6	MOD_ABS	L6	MOD_ABS
T7	RS0	L7	RS0
T8	RX_LOS	L8	RX_LOS
T9	Ground (GND)	L9	Ground (GND)
T10	Ground (GND)	L10	Ground (GND)
T11	Ground (GND)	L11	Ground (GND)
T12	RD-	L12	RD-
T13	RD+	L13	RD+
T14	Ground (GND)	L14	Ground (GND)
T15	VCCR(+3.3V Level)	L15	VCCR(+3.3V Level)
T16	VCCT(+3.3V Level)	L16	VCCT(+3.3V Level)
T17	Ground (GND)	L17	Ground (GND)
T18	TD+	L18	TD+
T19	TD-	L19	TD-
T20	Ground (GND)	L20	Ground (GND)
A	Down Fiber Port: Active		
B	Up Fiber Port: Active		
C	Down Fiber Port: Link		
D	Up Fiber Port: Link		

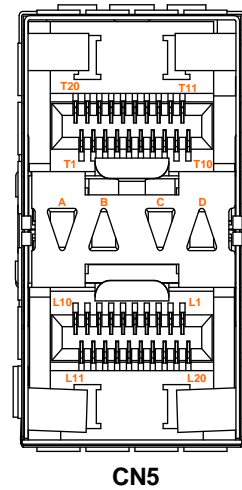



### 2.4.5 1X2 RJ45 Connector(CN6~CN10)

Pin	Signal	Pin	Signal
1	MDI0+	5	MDI2+
2	MDI0-	6	MDI2-
3	MDI1+	7	MDI3+
4	MDI1-	8	MDI3-
A	100 LAN LED (Green)/ 1000 LAN LED (Amber)		
B	Active LED (Orange)		

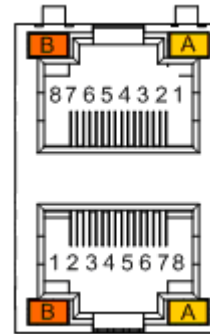

### 2.4.6 Console & USB3.0 Port0 ~ Port1 Connector (CN11)

Pin	Signal	Pin	Signal
1	USB_POWER	2	USBP2N
3	USBP2P	4	Ground (GND)
5	SSRX2N	6	SSRX2P
7	Ground (GND)	8	SSTX2N
9	SSTX2P	10	USB_POWER
11	USBP1N	12	USBP1P
13	Ground (GND)	14	SSRX1N
15	SSRX1P	16	Ground (GND)
17	SSTX1N	18	SSTX1P
19	NRTS1	20	MDTR1
21	MTXD1	22	COMGND
23	COMGND	24	MRXD1
25	NDSR1	26	NCTS1

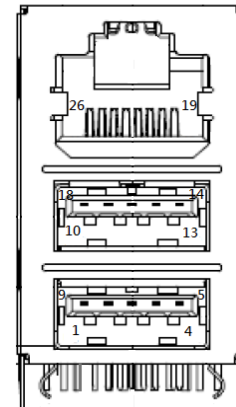

CN11

### 2.4.7 ATX +12V CPU Power Connector (ATX1)

Pin	Signal
1	GND
2	GND
3	GND
4	GND
5	+12V
6	+12V
7	+12V
8	+12V

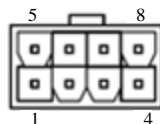

ATX1

### 2.4.8 USB Port Connectors (USB1~2)

The 10-pin standard Universal Serial Bus (USB) connector on this board is for installing versatile USB interface peripherals.

Pin	Signal	Pin	Signal
1	USB_POWER	2	USB_POWER
3	USB_PN1	4	USB_PN2
5	USB_PP1	6	USB_PP2
7	GND	8	GND
9	GND	10	GND

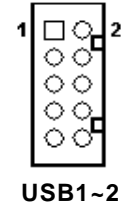

### 2.4.9 FAN Connectors (FAN1~3)

System fans are always needed to cool down CPU and system temperature. FAN1 ~ FAN3 connectors provide power to these system fans.(default use FAN1 and FAN2 for system)

Pin	Signal
1	Ground (GND)
2	+12V
3	Rotation Detection In
4	Rotation Detection Out

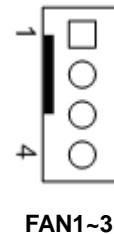

### 2.4.10 Serial Port 2 Connector (COM2)

The COM port pin assignments are listed on the following table.

Pin	Signal
1	Data Carrier Detect (DCD)
2	Data Set Ready(DSR)
3	Receive Date(RXD)
4	Request to Send(RTS)
5	Transmit Data(TXD)
6	Clear to Send(CTS)
7	Data Terminal Ready(DTR)
8	Ring Indicator(RI)
9	Ground (GND)
10	NC

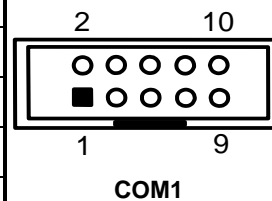

### 2.4.11 Serial ATA Connectors (SATA1.2.3.4)

These Serial Advanced Technology Attachment (SATA) connectors are for high-speed SATA interface ports. They are computer bus interfaces for connecting to devices such as serial ATA hard disk drives. Each SATA connector supports a single SATA device.

Pin	Signal	Pin	Signal
1	GND	2	TX+
3	TX-	4	GND
5	RX-	6	RX+
7	GND		

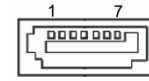

SATA1~4

### 2.4.12 Front Panel Bezel Connector (JP5)

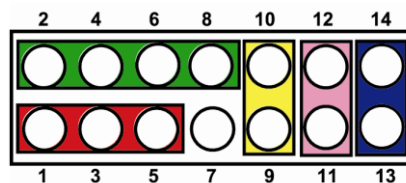

#### Power LED :

This 3-pin connector (Pin 1, 3, 5) connects a LED indicator to the system power switch on the case. Pin 1 is assigned as +, and Pin 3, Pin 5 as -. The Power LED lights up when the system is powered ON.

#### External Speaker and Internal Buzzer Connector :

This 4-pin connector (Pin 2, 4, 6, 8) can be connected to the case-mounted speaker unit or internal buzzer. While connecting the CPU card to an internal buzzer, please short pins 2-4; while connecting to an external speaker, you need to set pins 2-4 to Open and connect the speaker cable to pin 8 (+) and pin 2 (-).

#### ATX Power On/Off Button :

This 2-pin connector (Pin 9, 10) connects the front panel's ATX power button to the CPU card, which allows users to control ATX power supply to be power on/off.

#### System Reset Switch :

This 2-pin connector (Pin 11, 12) can be connected to the case-mounted reset switch that reboots your computer instead of turning OFF the power switch. It is a better way to reboot your system for a longer life of the system's power supply.

#### HDD Activity LED :

This connection is linked to hard drive activity LED on the control panel. LED flashes when HDD is being accessed. The 2-pin connector (Pin 13, 14) connects the hard disk drive to the front panel HDD LED, Pin 13 assigned as -, and Pin 14 as +.

### 2.4.13 VGA Connector (VGA1)

This is a 16-pin connector which is commonly used for CRT VGA monitor.

Pin	Signal
1	VGA_R
2	CRT_DETECT
3	VGA_G
4	NC
5	VGA_B
6	GND
7	VCC +5V
8	VGADDCDATA
9	GND
10	GND
11	GND
12	DAC_L_HSYNC
13	GND
14	DAC_L_VSYNC
15	VGADDCCLK
16	NC

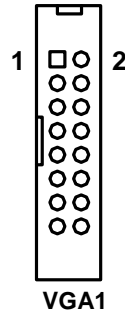

### 2.4.14 Digital I/O Port Connector (DIO1)

The board is equipped with an 8-channel (4 inputs and 4 outputs) digital I/O connector that meets requirements for a system customary automation control. The digital I/O can be configured to control cash drawers and sense warning signals from an Uninterrupted Power System (UPS), or perform store security control. You may use software programming to control these digital signals. The software application method is provided in Appendix B.

Pin	Signal
1	Ground (GND)
2	Ground (GND)
3	Digital Output 3
4	Digital Input 3
5	Digital Output 2
6	Digital Input 2
7	Digital Output 1
8	Digital Input 1
9	Digital Output 0
10	Digital Input 0

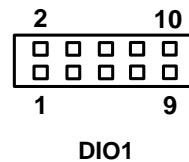

## 2.5 Hardware Installation

This section provides information of how to install the NA590 Series.

### 2.5.1 Installing the CPU

Before installing the processor, please access Intel® website for more detail information of Processor Integration Video (LGA1151):

<http://www.intel.com/support/tw/processors/sb/CS-030860.htm> .

The LGA1151 processor socket comes with a cover to protect the processor. Please install the processor into the CPU socket step by step as below:

#### Step 1 Opening the socket:

- Disengage load lever by releasing down and out on the hook. This will clear retention tab.
- Rotate load lever to open position at approximately 135°.
- Rotate load plate to open position at approximately 150°.



**Note:** Apply pressure to corner with right-hand thumb when opening or closing load lever - otherwise lever will bounce back (as a mouse trap) causing bent contacts.

#### Step 2 Removing the socket protective cover:

- Place thumb against the front edge of the protective cover and rest index finger on the rear grip to maintain control of the cover.
- Lift the front edge of the protective cover to disengage from the socket. Keep control of the cover by holding the rear grip with index finger.
- Lift protective cover away from the socket, being careful not to touch the electrical contacts.





**Note:** Vertical removal is *NOT* recommended, as it requires higher force and can lead to socket contact damage.

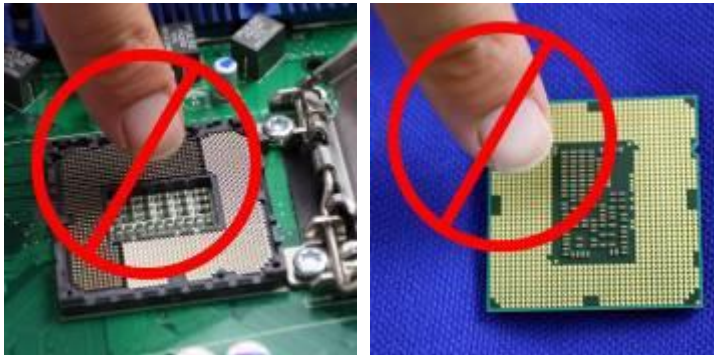

**Caution:** Never touch fragile socket contacts to avoid damage and do not touch processor sensitive contacts at any time during installation.

### Step 3 Processor installation:

- Lift processor package from shipping media by grasping the substrate edges.



- Scan the processor package gold pads for any presence of foreign material. If necessary, the gold pads can be wiped clean with a soft lint-free cloth and isopropyl alcohol.
- Locate connection 1 indicator on the processor which aligns with connection 1 indicator chamfer on the socket, and notice processor keying features that line up with posts along socket walls.

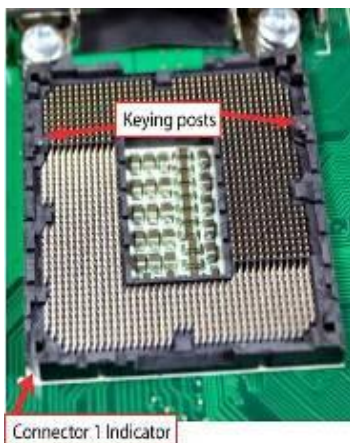

- Grasp the processor with thumb and index finger along the top and bottom edges. (Do not touch the orientation notches.) The socket will have cutouts for your fingers to fit into (see image below).
- Carefully place the processor into the socket body vertically (see image below).



**Note:** *Tilting or roughly shifting it into place can damage socket contacts.*



**Caution:** *Do not use a vacuum pen for installation.*



- Verify that package is within the socket body and properly connected to orientation keys.

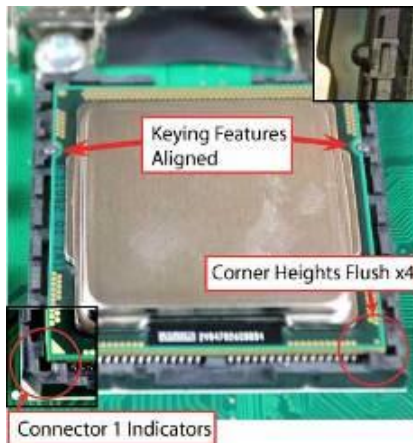

- Close the socket (see image below):
  1. Gently lower the load plate.
  2. Make sure load plate's front edge slides under the shoulder screw cap as the lever is lowered.
  3. Latch the lever under the top plate's corner tab, being cautious not to damage the motherboard with the tip of the lever.

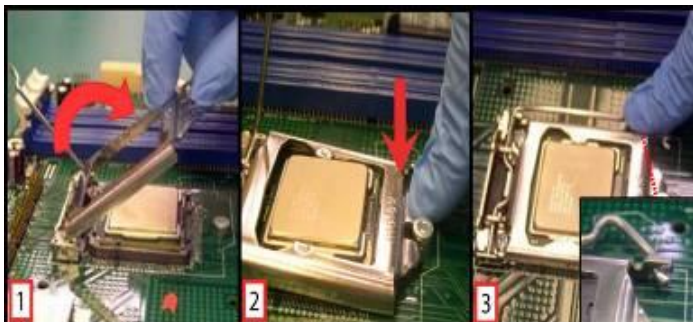

## 2.5.2 Installing the Memory

The board supports four 240-pin DDR4 UDIMM memory sockets with maximum memory capacity up to 32GB.

Please follow steps below to install the memory modules:

1. Push down latches on each side of the DIMM socket.
2. Align the memory module with the socket that notches of memory module must match the socket keys for a correct installation.
3. Install the memory module into the socket and push it firmly down until it is fully seated. The socket latches are levered upwards and clipped on to the edges of the DIMM.
4. Install any remaining DIMM modules.

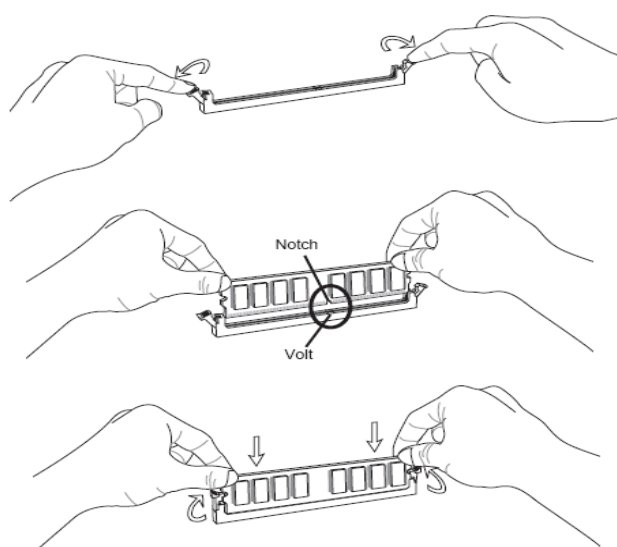



### 2.5.3 Installing the Hard Disks

The system supports or two 2.5" HDDs or one 3.5" HDD.

- Two 2.5" HDD

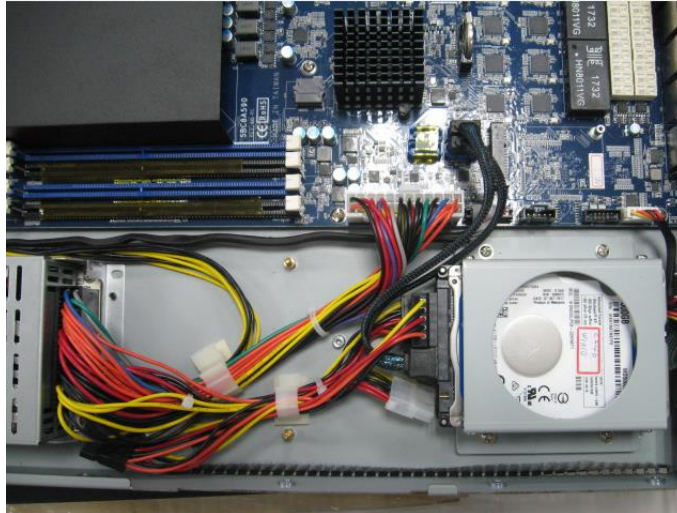

- One 3.5" HDD



**This page is intentionally left blank.**

# Chapter 3

## AMI BIOS Setup Utility

The AMI BIOS provides users with a built-in setup program to modify basic system configuration. All configured parameters are stored in a battery-backed-up RAM (CMOS RAM) to save the setup information whenever the power is turned off. This chapter provides users with detailed description about how to set up basic system configuration through the AMI BIOS setup utility.

### 3.1 Starting

To enter the setup screens, follow the steps below:

1. Turn on the computer and press the <DEL>or<ESC> key immediately.
2. After you press the <DEL>or<ESC> key, the main BIOS setup menu displays. You can access the other setup screens from the main BIOS setup menu, such as the Advanced and Chipset menus.

It is strongly recommended that you should avoid changing the chipset's defaults. Both AMI and your system manufacturer have carefully set up these defaults that provide the best performance and reliability.

### 3.2 Navigation Keys

The BIOS setup/utility uses a key-based navigation system called hot keys. Most of the BIOS setup utility hot keys can be used at any time during the setup navigation process. These keys include <F1>, <F2>, <Enter>, <ESC>, <Arrow> keys, and so on.



**Note:** Some of the navigation keys differ from one screen to another.

Hot Keys	Description
→← Left/Right	The Left and Right <Arrow> keys allow you to select a setup screen.
↑↓ Up/Down	The Up and Down <Arrow> keys allow you to select a setup screen or sub-screen.
+– Plus/Minus	The Plus and Minus <Arrow> keys allow you to change the field value of a particular setup item.
Tab	The <Tab> key allows you to select setup fields.
F1	The <F1> key allows you to display the general help screen.
F2	The <F2> key allows you to load previous values.
F3	The <F3> key allows you to load optimized defaults.
F4	The <F4> key allows you to save any changes you have made and exit setup. Press the <F4> key to save your changes.
Esc	The <Esc> key allows you to discard any changes you have made and exit the setup. Press the <Esc> key to exit the setup without saving your changes.
Enter	The <Enter> key allows you to display or change the setup option listed for a particular setup item. The <Enter> key can also allow you to display the setup sub- screens.

### 3.3 Main Menu

When you first enter the setup utility, you will enter the Main setup screen. You can always return to the Main setup screen by selecting the Main tab. System Time/Date can be set up as described below. The Main BIOS setup screen is shown below.

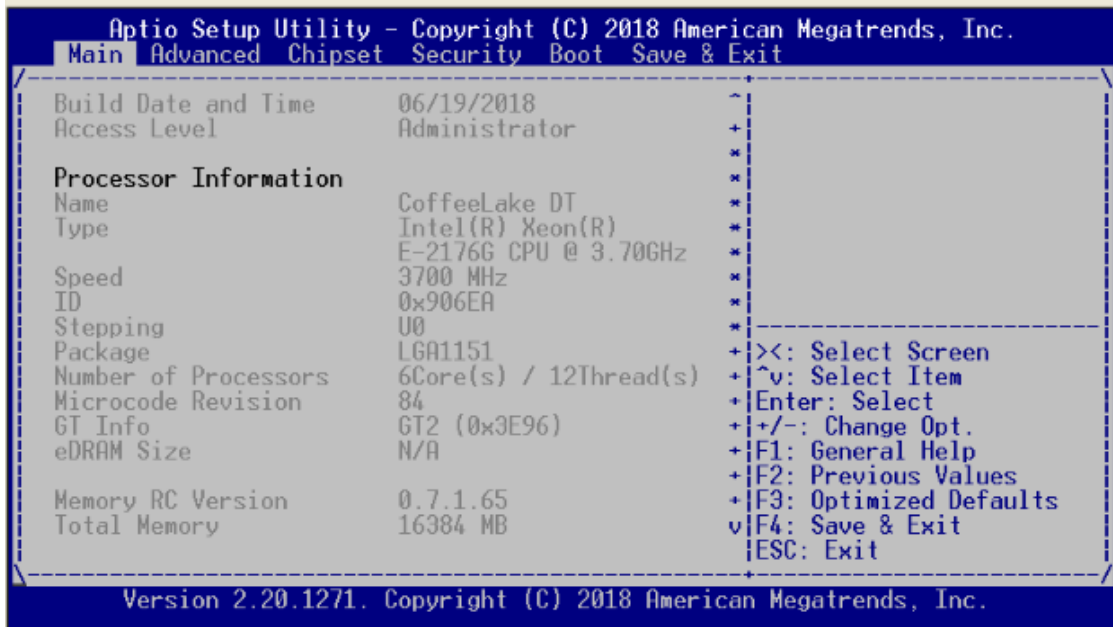

#### System Date/Time

Use this option to change the system time and date. Highlight System Time or System Date using the <Arrow> keys. Enter new values through the keyboard. Press the <Tab> key or the <Arrow> keys to move between fields. The date must be entered in MM/DD/YY format. The time is entered in HH:MM:SS format.

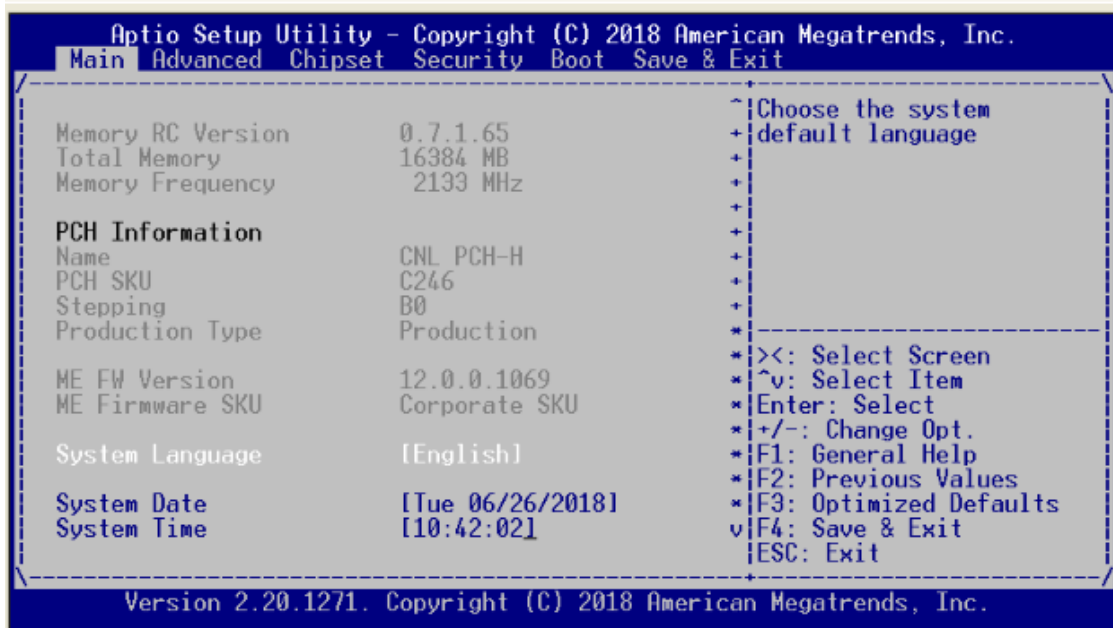

### 3.4 Advanced Menu

The Advanced menu also allows users to set configuration of the CPU and other system devices. You can select any of the items in the left frame of the screen to go to the sub menus:

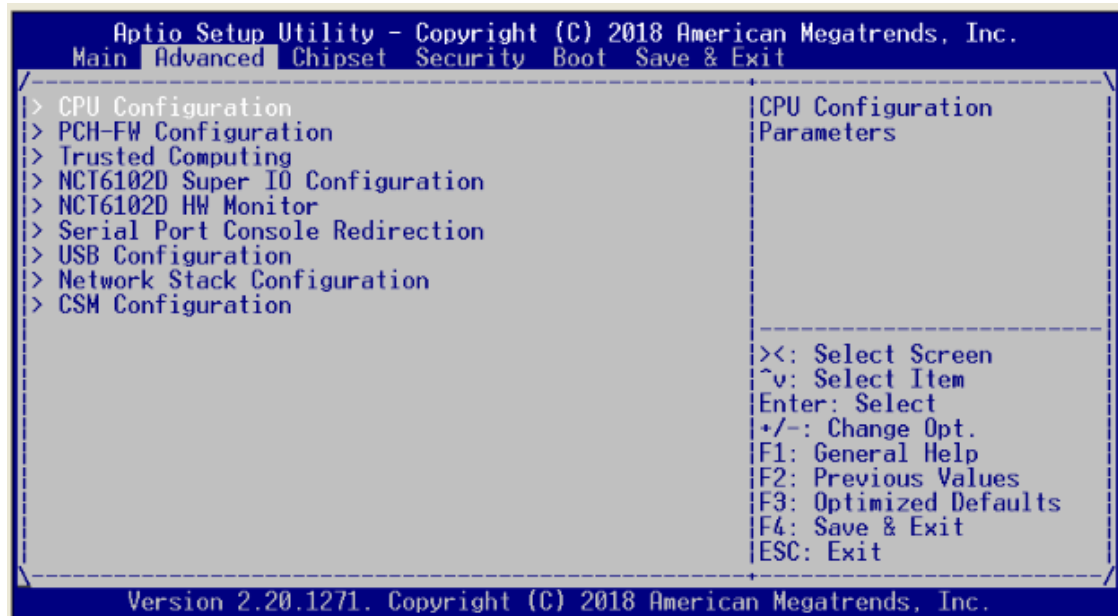

- ▶ CPU Configuration
- ▶ PCH-FW Configuration
- ▶ Trusted Computing
- ▶ NCT6102D Super IO Configuration
- ▶ NCT6102D HW Monitor
- ▶ Serial Port Console Redirection
- ▶ USB Configuration
- ▶ Network Stack Configuration
- ▶ CSM Configuration

For items marked with “▶”, please press <Enter> for more options.

- **CPU Configuration**

This screen shows the CPU Configuration, and you can change the value of the selected option.

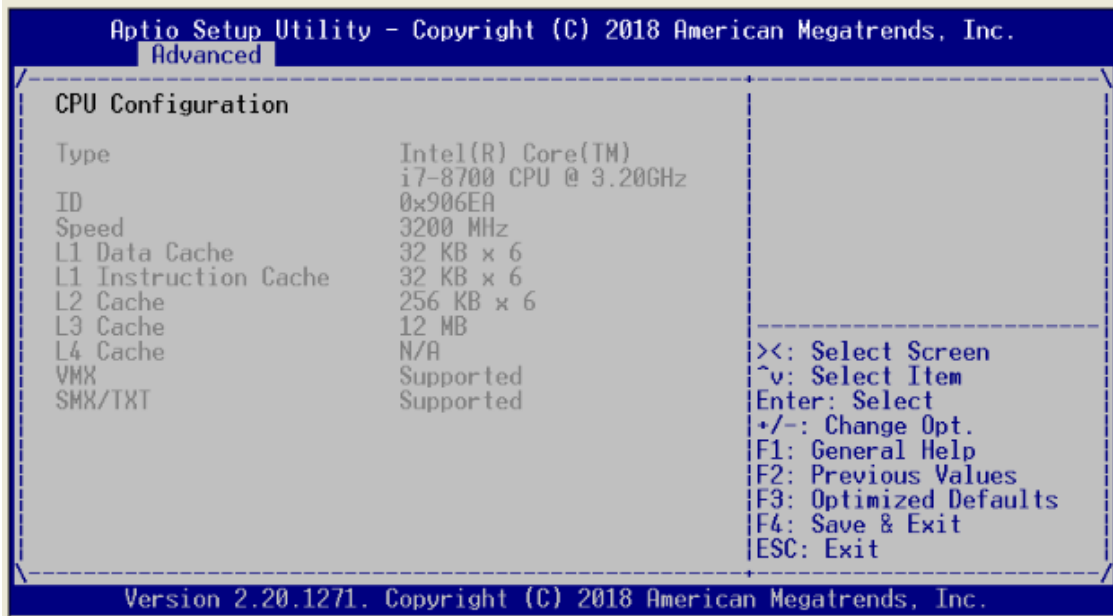
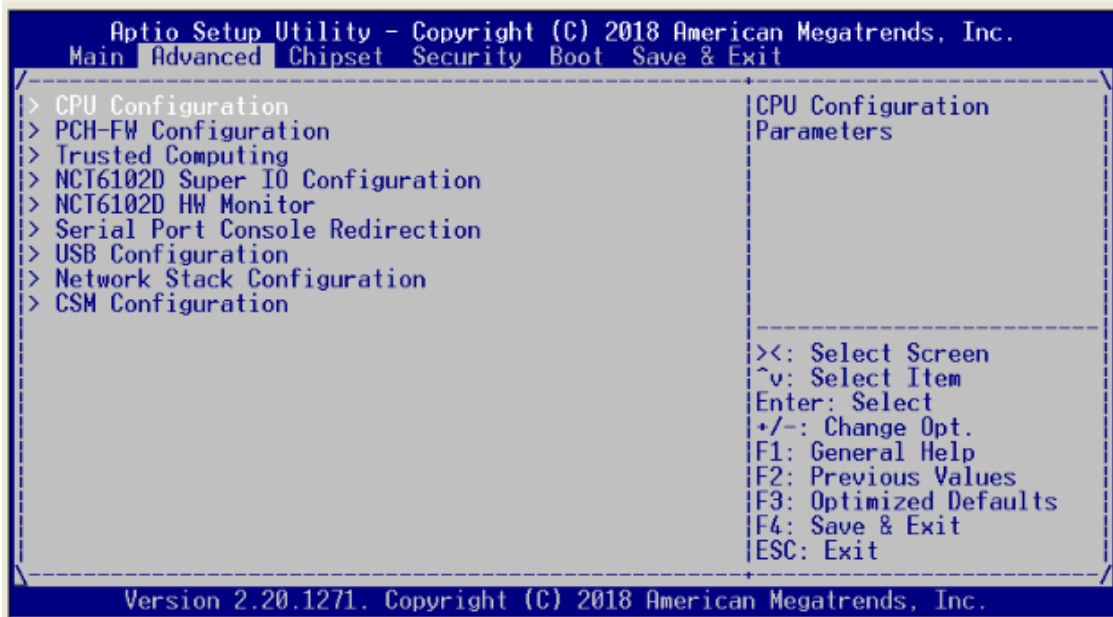

● **PCH-FW Configuration**

You can use this screen to select options for the PCH-FW Configuration, and change the value of the selected option. A description of the selected item appears on the right side of the screen. For items marked with "▶", please press <Enter> for more options.

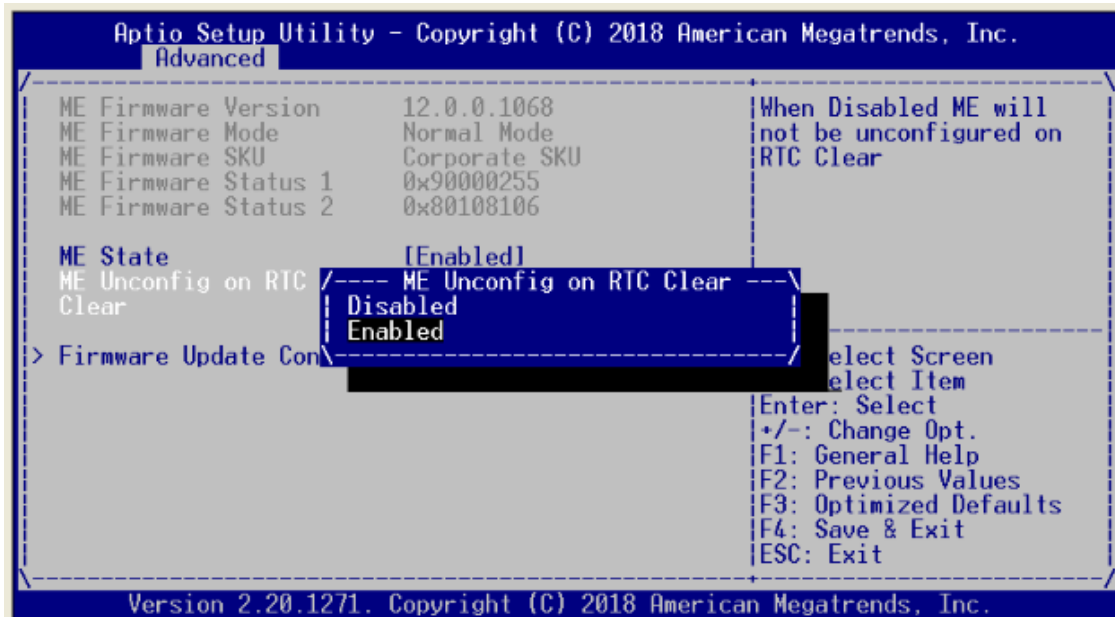
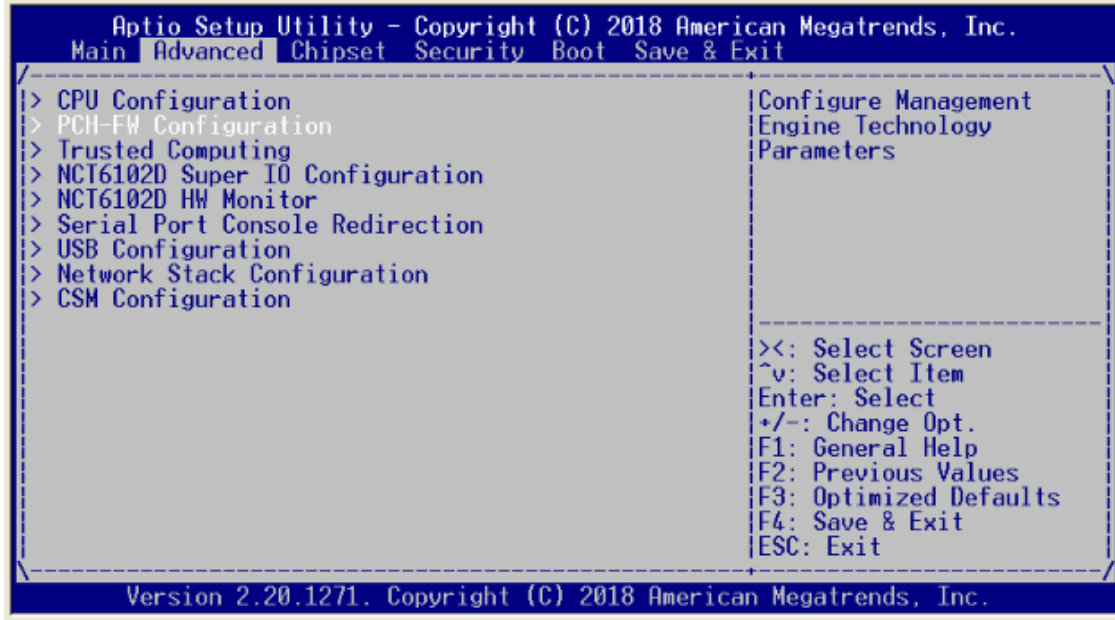

- **Trusted Computing**

This item supports security devices. "Enable" or "Disable" BIOS support for security devices.

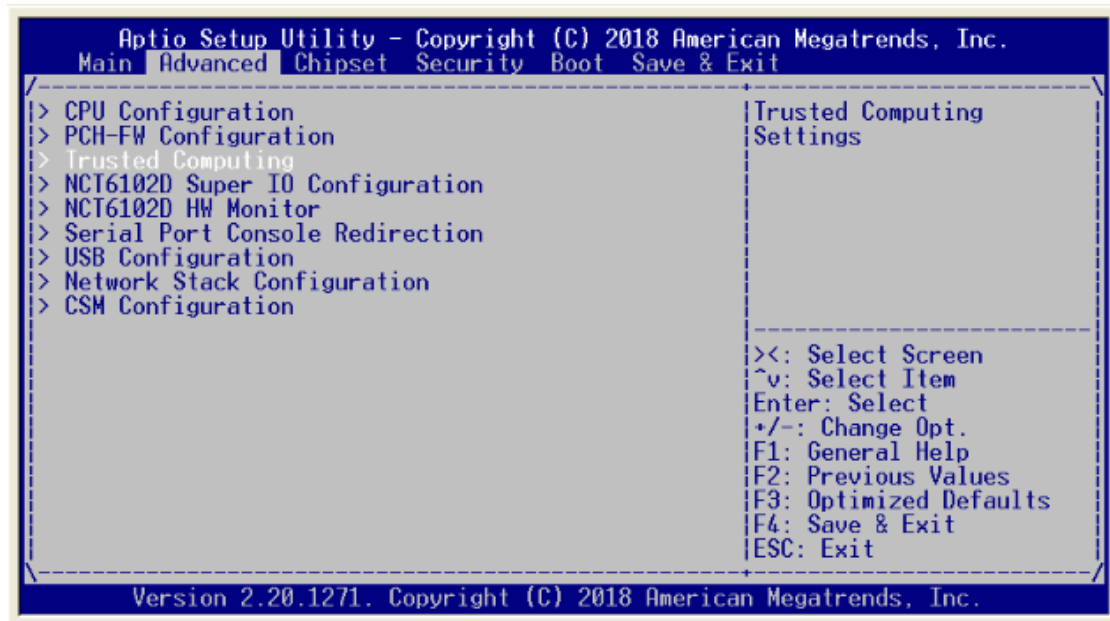

If you installed the Security device, such as TPM, you could see the following information for the TPM device and status.

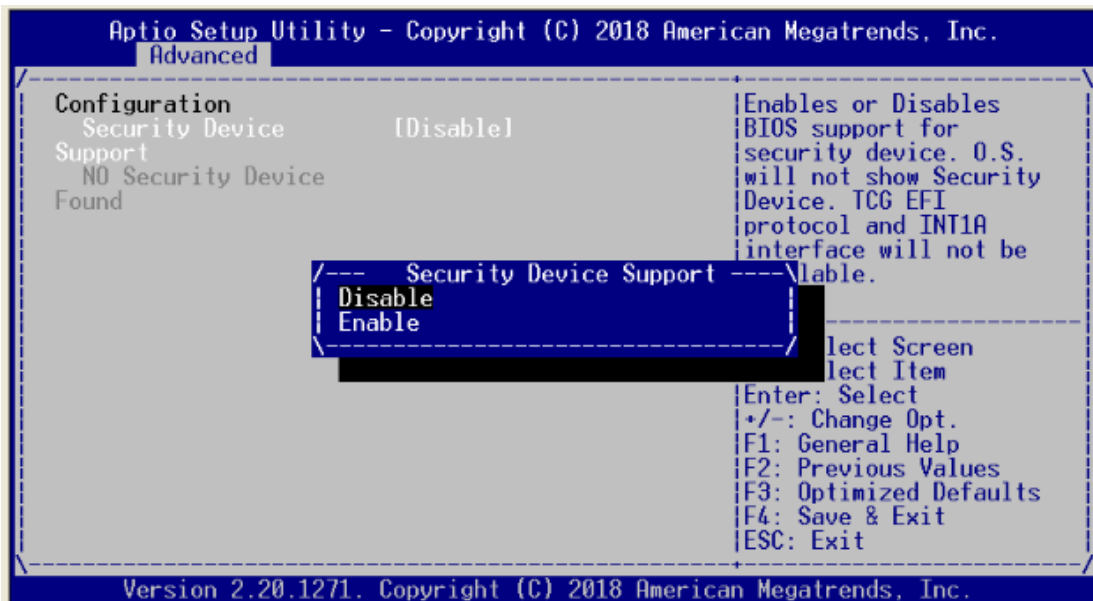



● **NCT6102D Super IO Configuration**

You can use this screen to select options for the NCT6102D Super IO Configuration, and change the value of the selected option. A description of the selected item appears on the right side of the screen. For items marked with "►", please press <Enter> for more options.

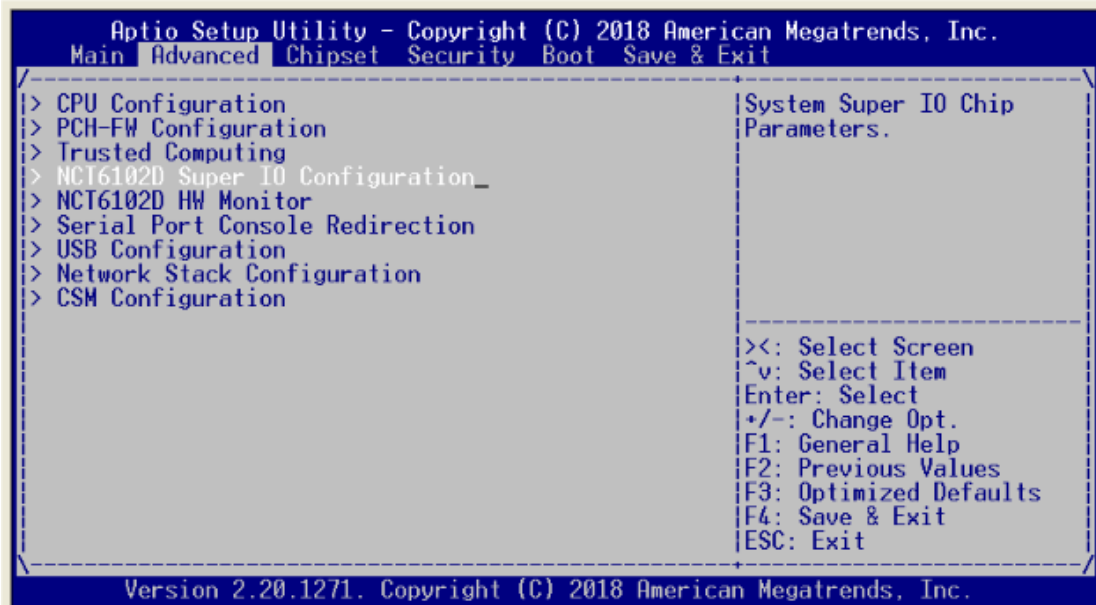

➤ **Serial Port 1 Configuration**

This option specifies the base I/O port address and Interrupt Request address of serial port 1. The Optimal setting is 3F8h/IRQ4.

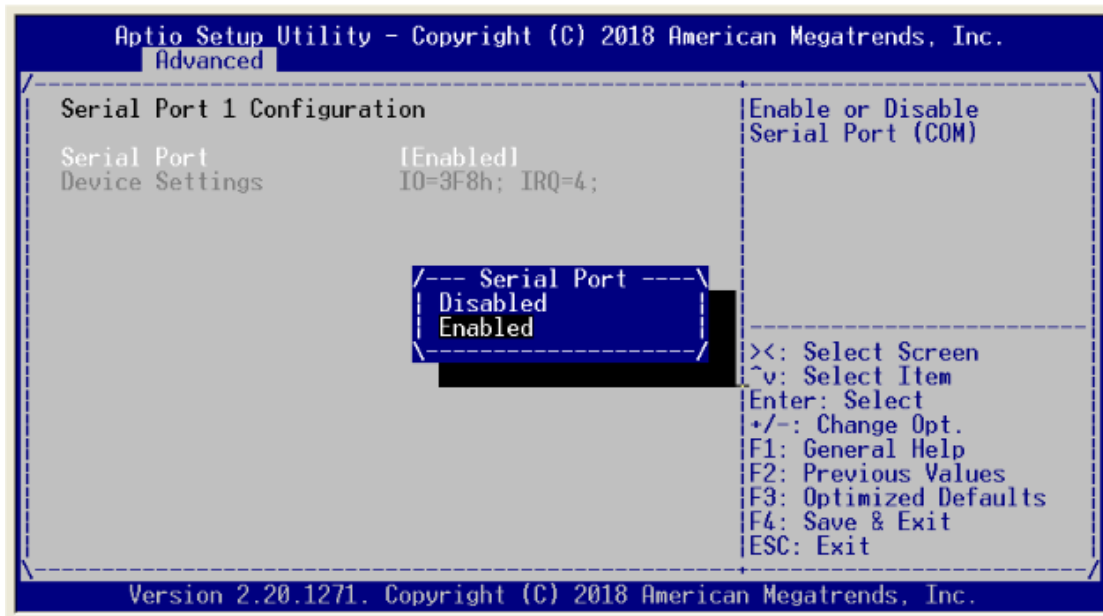

➤ **Serial Port 2 Configuration**

This option specifies the base I/O port address and Interrupt Request address of serial port 2. The Optimal setting is 2E8h/IRQ3.

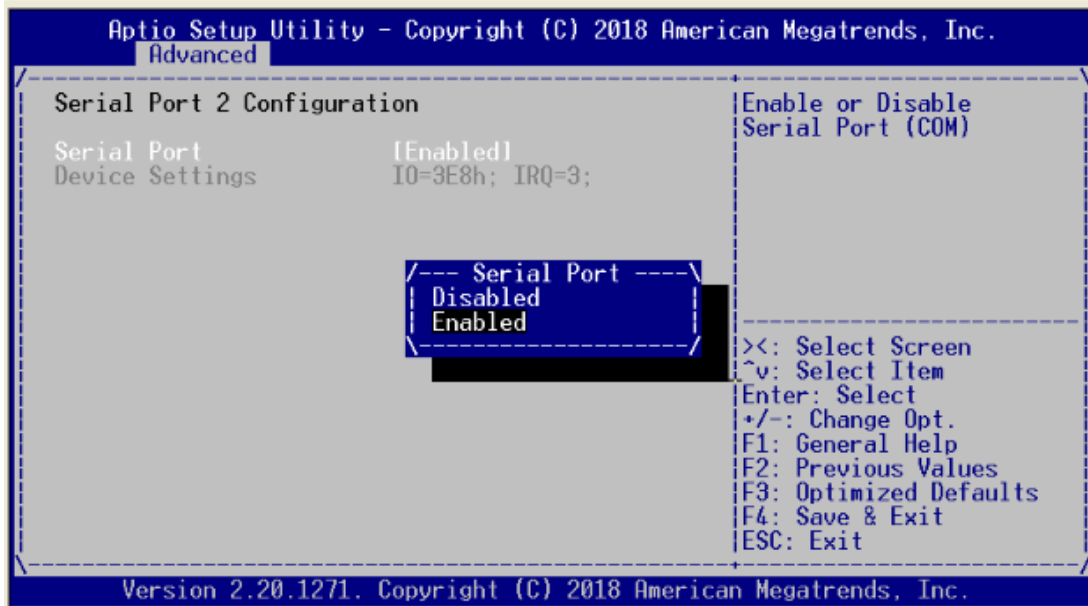

● **NCT6102D H/W Monitor**

This screen monitors is hardware health.

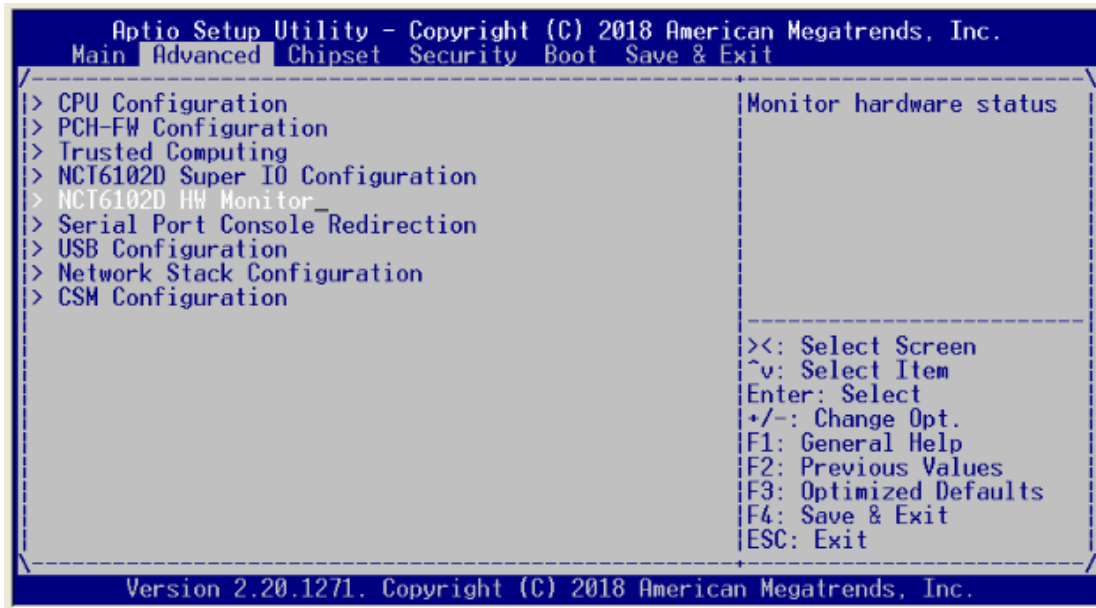

This screen displays the temperature of system and CPU, cooling fan speed in RPM and system voltages (VCORE, +1.5V and +12V).

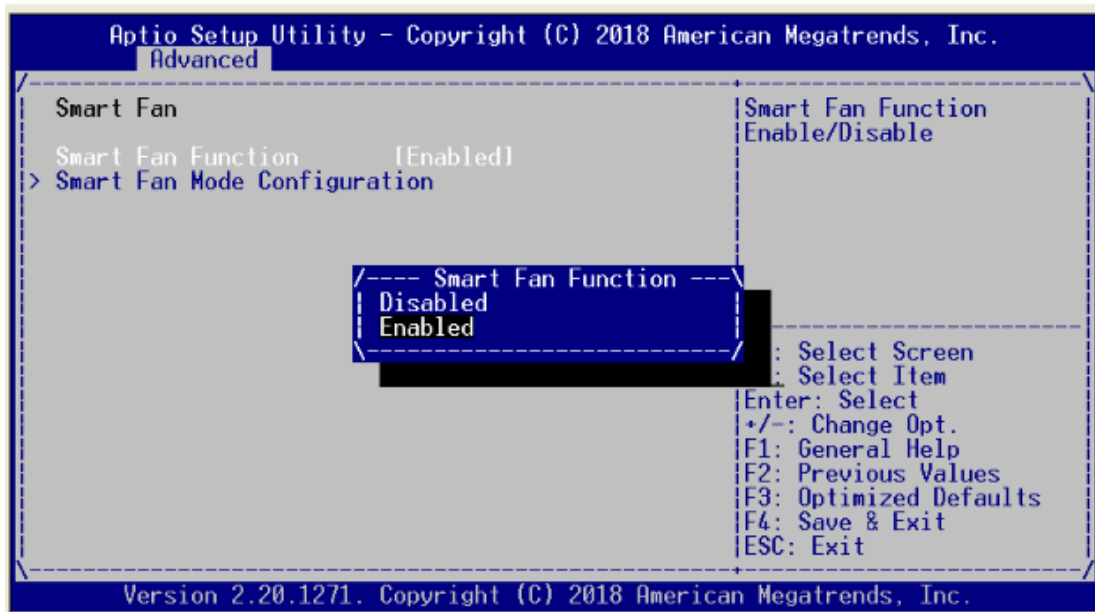
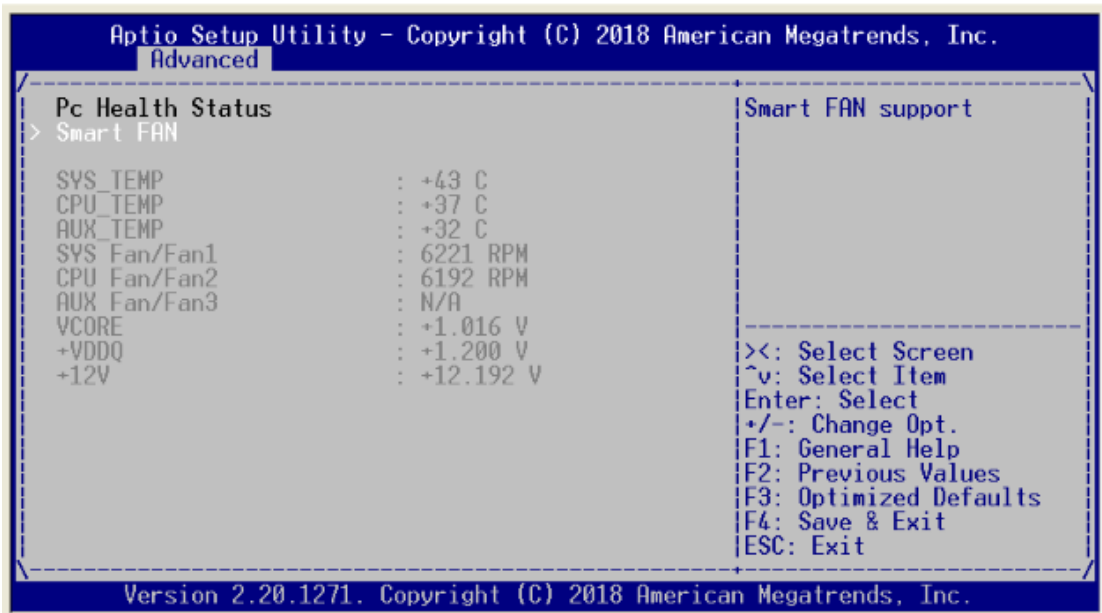

- **Serial Port Console Redirection**

- **Console Redirection**

Use this item to enable or disable console redirection. The settings specify how the host computer and remote computer (which the user is using) will exchange data. Both computers should have the same or compatible setting.

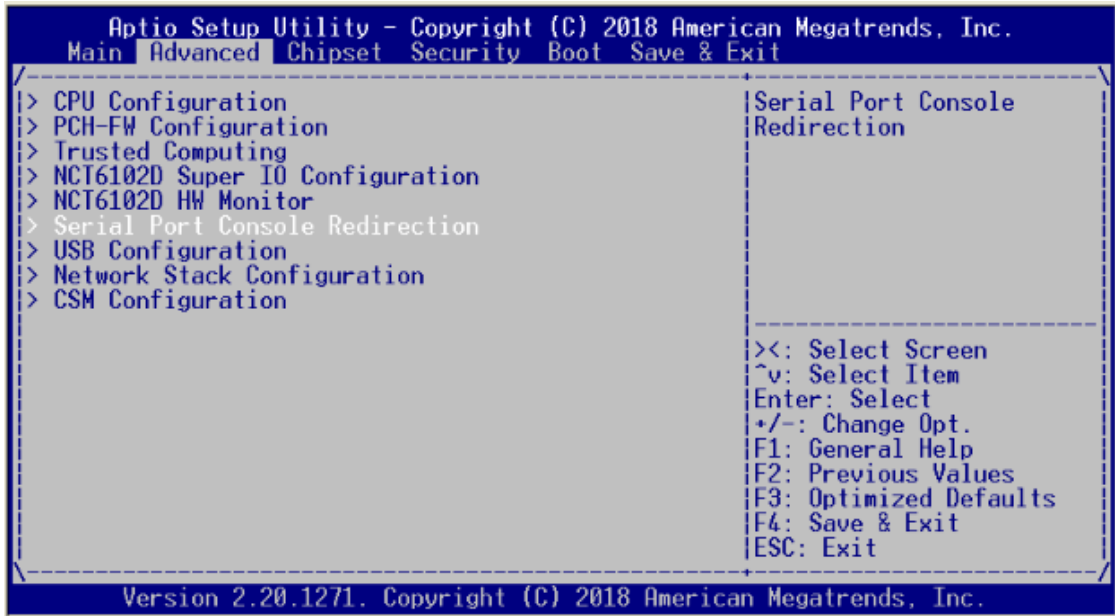

- **Console Redirection Settings**

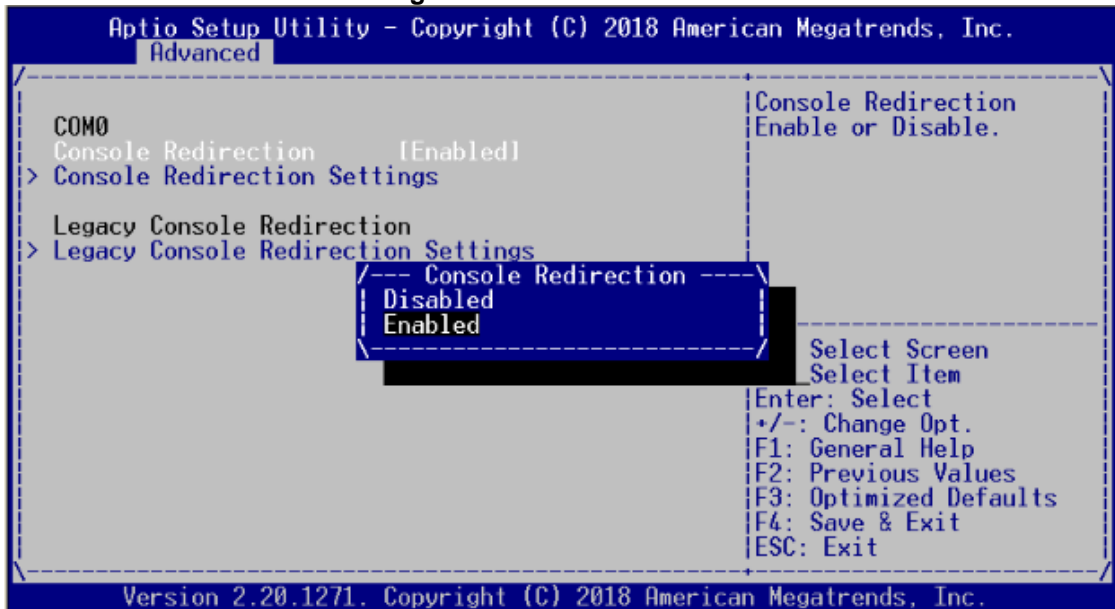

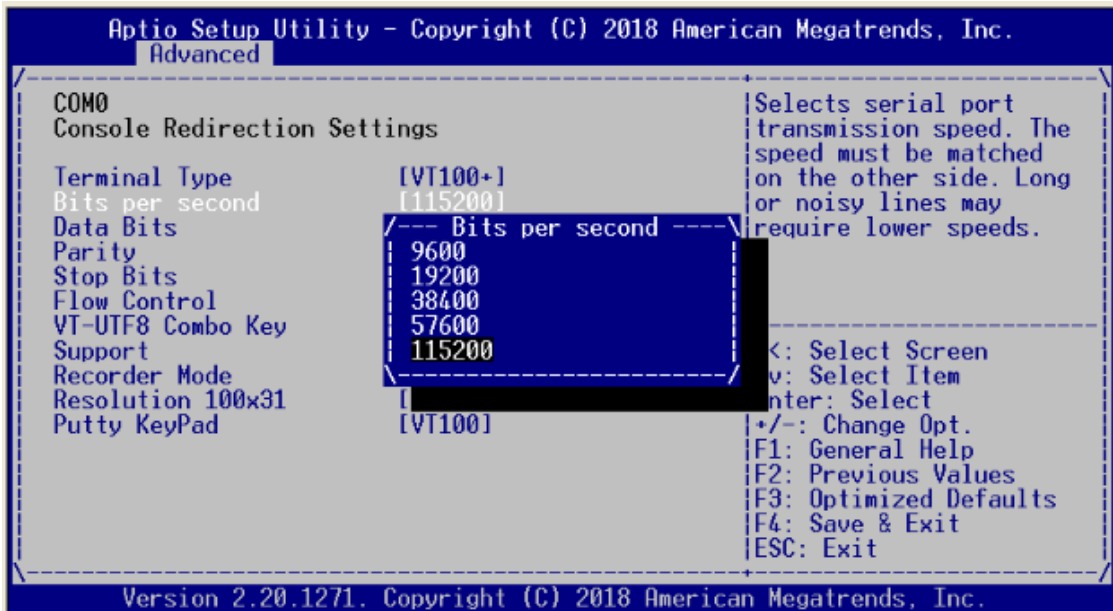
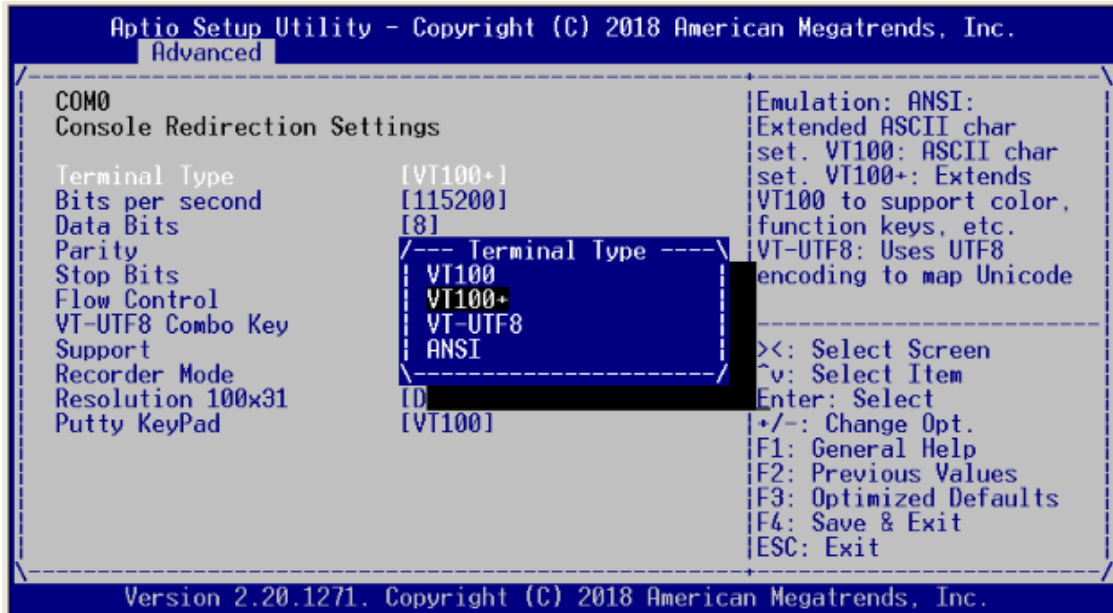

**Terminal Type**

This item allows you to select the target terminal type. Configuration options: ANSI, VT100, VT100+ and VT-UTF8.

**Bits per second**

This item allows you to setup the data transfer rate for the console port. The default value is 115200. Available options are "9600", "19200", "38400", "57600" and "115200".

**Data Bits**

This item allows you to select the data bits. The configuration options: 7 and 8.

**Parity**

This item allows you to select flow control for console redirection. The configuration options: None, Even, Odd, Mark and Space.

**Stop Bits**

This item allows you to select the data bits. The configuration options: 1 and 2.

### Flow Control

This item allows you to select flow control for console redirection. The configuration options: None and Hardware RTS/CTS.

### VT-UTF8 Combo Key Support

Use this item to Enabled and Disabled VT-UTF8 combination key supports for ANSI / VT100 terminals.

### Recorder Mode

This item allows you to select the recorder mode. The configuration options: Enabled and Disabled.

- **USB Configuration**

Use this item for further setting USB port configuration.

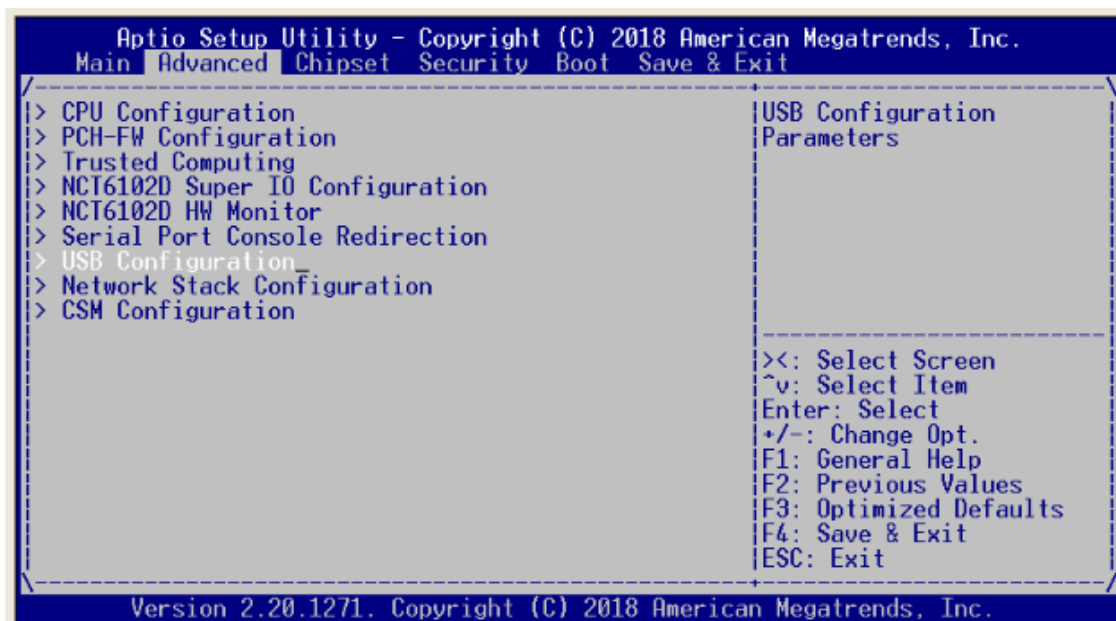

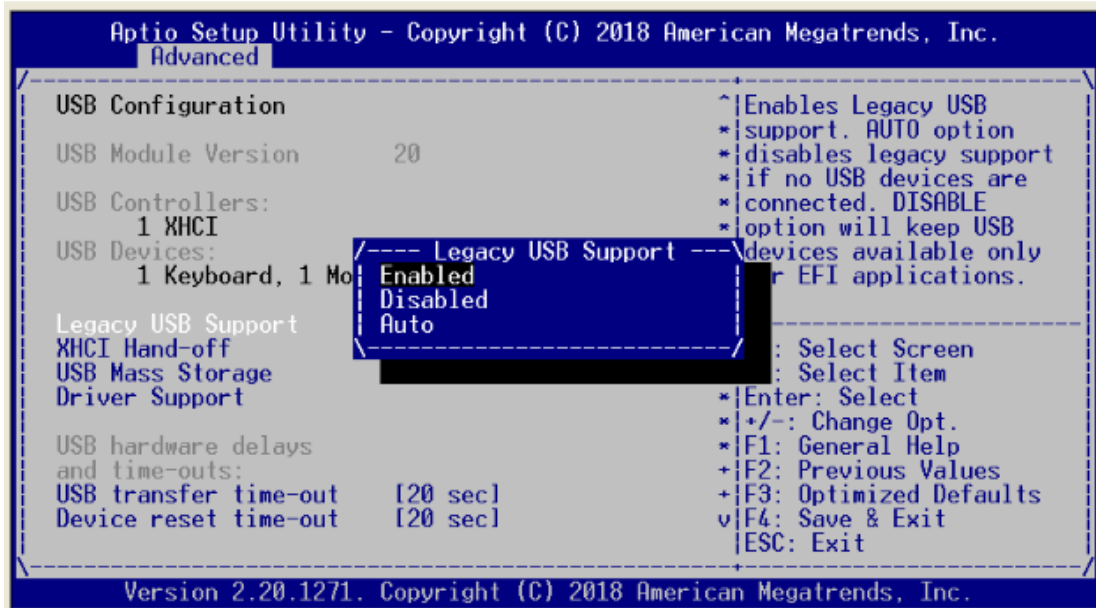

**XHCI Hand-off**

Enable this field when using operating systems without the XHCI hand-off support.

**USB Mass Storage Driver Support**

Enable this field USB can be storage. This should be enabled this field.

**USB transfer time-out**

Setting 20seconds (time-out interval), the host controller starts a timer when it receives the transfer request.

- **Network Stack Configuration**

For Network stack, use Network item to "Disabled" or "Enabled" mode.

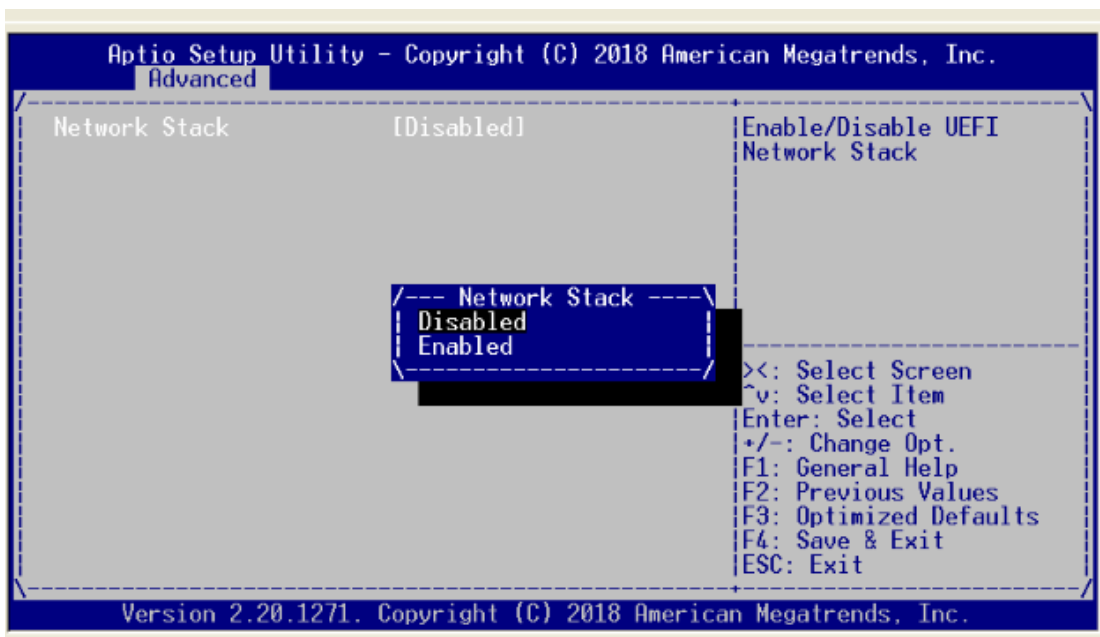
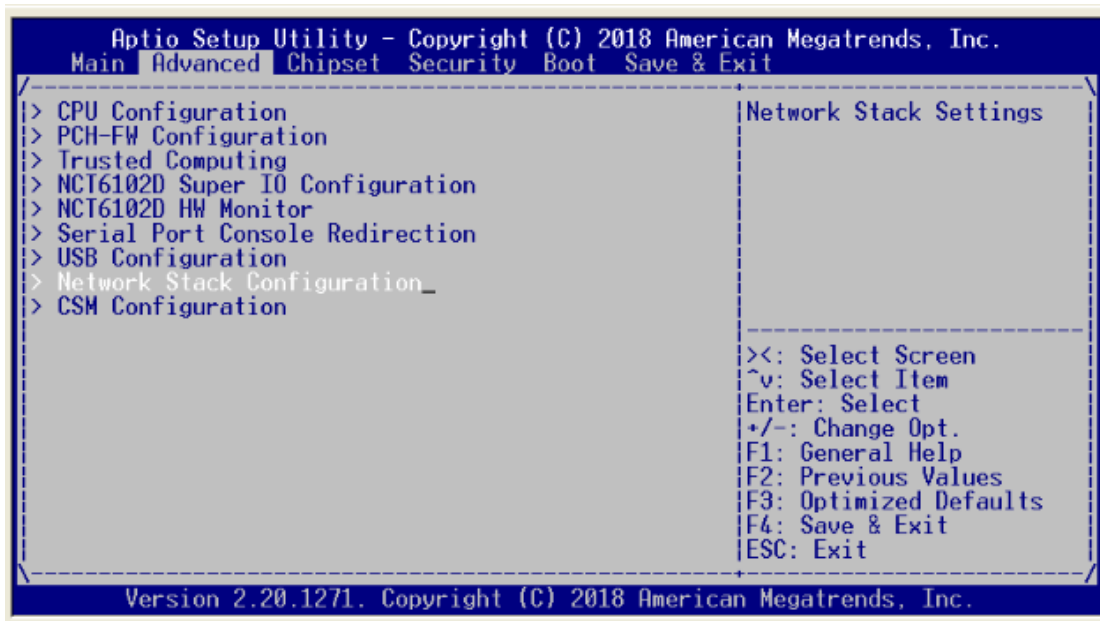



- **CSM Configuration**

This screen shows the CSM Configuration, and you can enable/disable option ROM execution settings.

```
Aptio Setup Utility - Copyright (C) 2018 American Megatrends, Inc.
Main Advanced Chipset Security Boot Save & Exit

> CPU Configuration
> PCH-FW Configuration
> Trusted Computing
> NCT6102D Super IO Configuration
> NCT6102D HW Monitor
> Serial Port Console Redirection
> USB Configuration
> Network Stack Configuration
> CSM Configuration_

CSM configuration:
Enable/Disable, Option
ROM execution settings,
etc.

><: Select Screen
^v: Select Item
Enter: Select
+/-: Change Opt.
F1: General Help
F2: Previous Values
F3: Optimized Defaults
F4: Save & Exit
ESC: Exit

Version 2.20.1271. Copyright (C) 2018 American Megatrends, Inc.
```

- **LBP @PowerOn (All SEG)**

For Power On LAN Bypass setting, use LBP @PowerOn item to “Disabled” ,“Enabled” or “Last State” for LAN Bypass all segments.

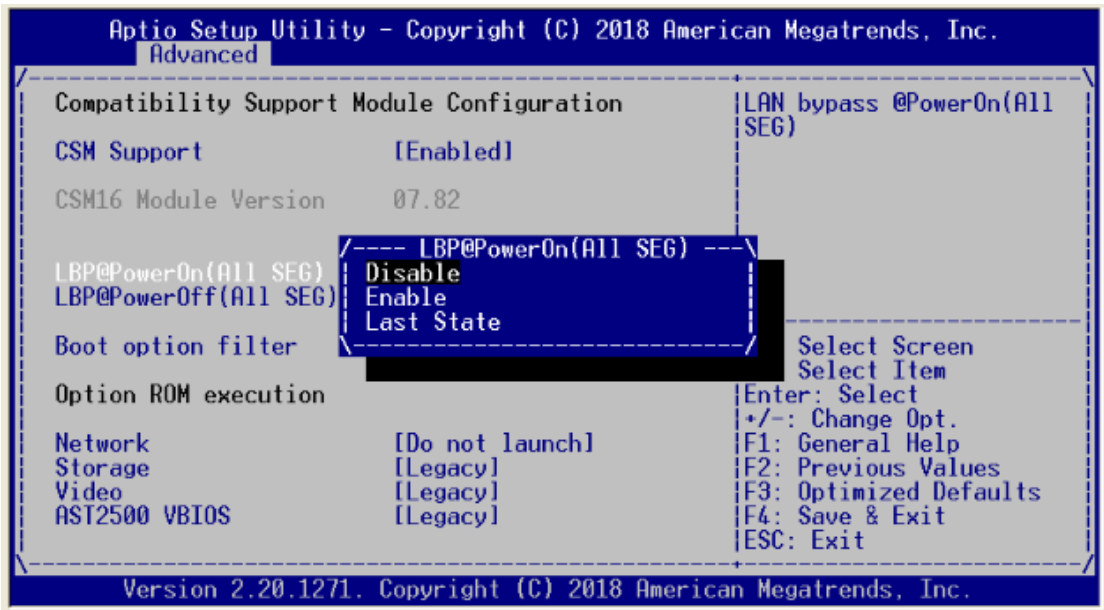

- **LBP @Power Off (All SEG)**

For Power off LAN Bypass setting, use LBP @PowerOff item to “Disabled” ,“Enabled” or “Last State” for LAN Bypass all segments.

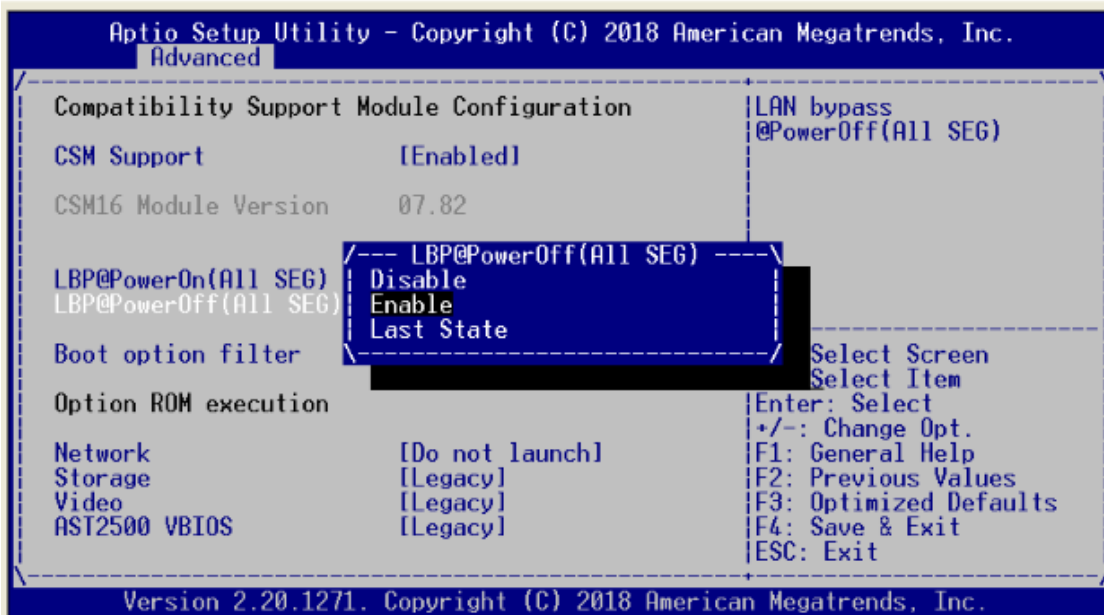

- **Network**

For Network setting, use Network item to “Do not launch” or “UEFI” or “legacy” mode.

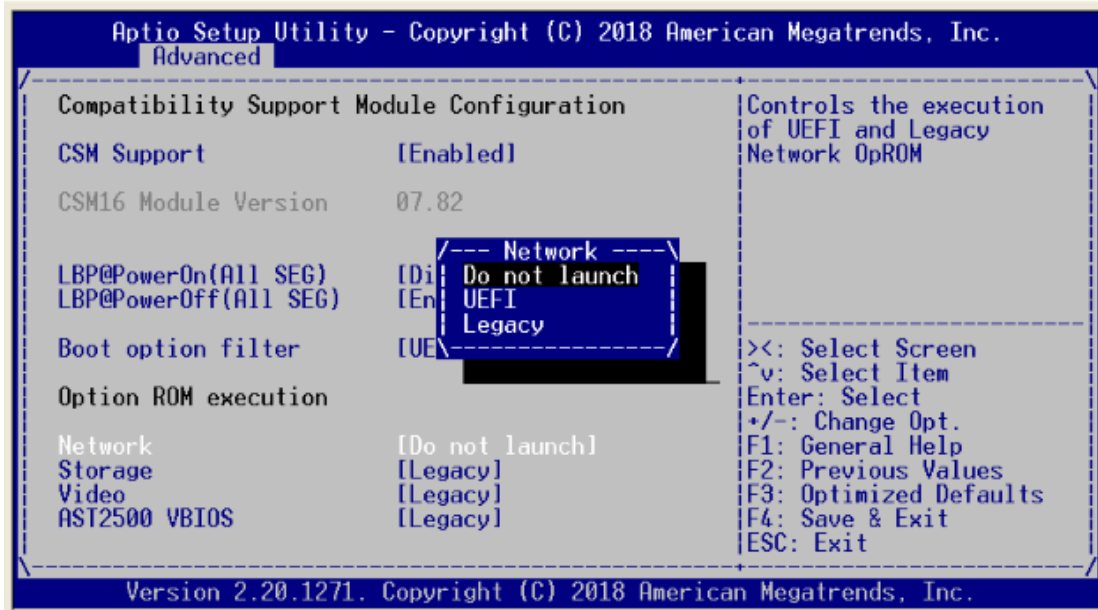

## 3.5 Chipset Menu

The Chipset menu allows users to change the advanced chipset settings. You can select any of the items in the left frame of the screen to go to the sub menus:

- ▶ System Agent (SA) Configuration
- ▶ PCH-IO Configuration

For items marked with “▶”, please press <Enter> for more options.

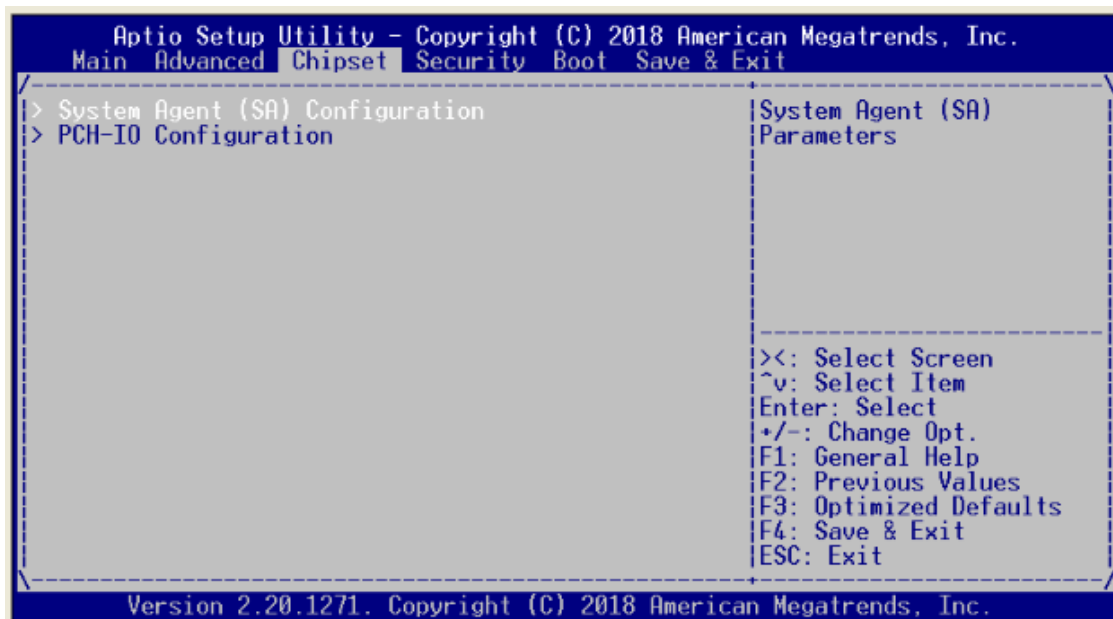

- **System Agent (SA) Configuration**

- **Memory Configuration**

This screen allows users to configure parameters of North Bridge Chipset.

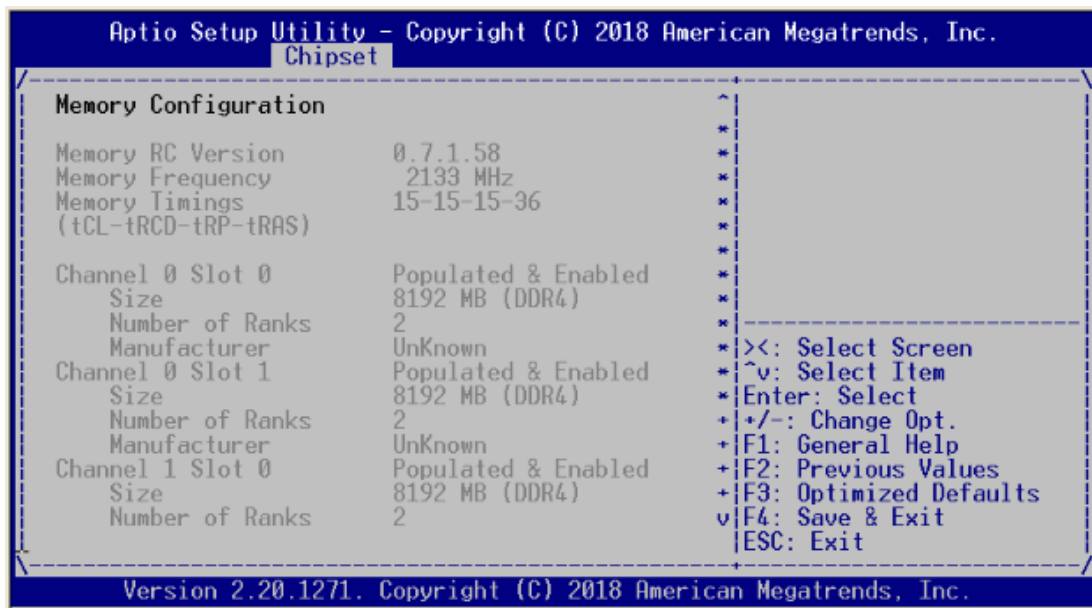
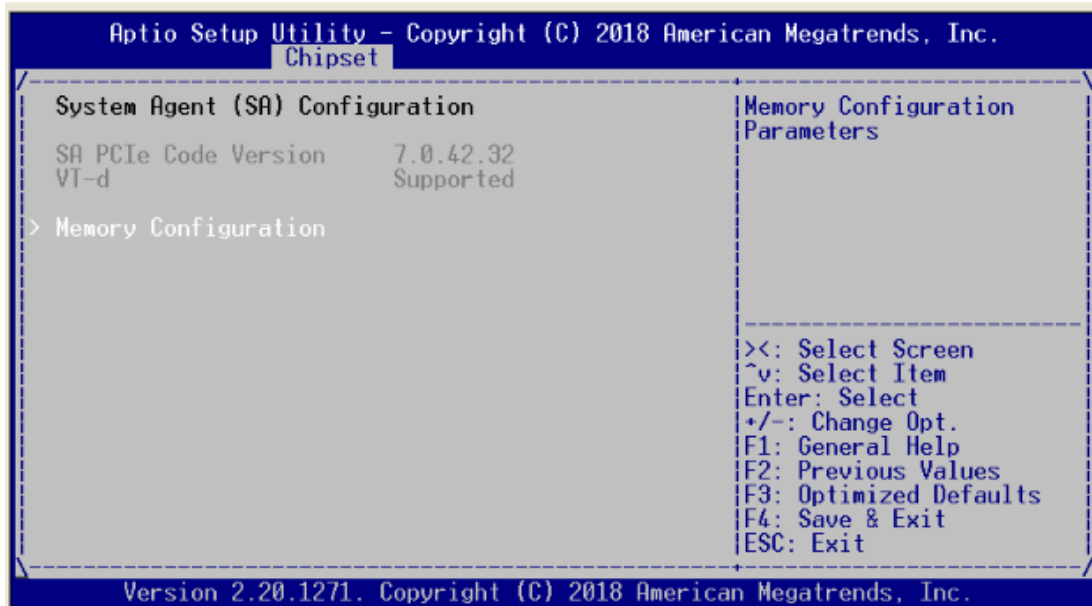

● PCH-IO Configuration

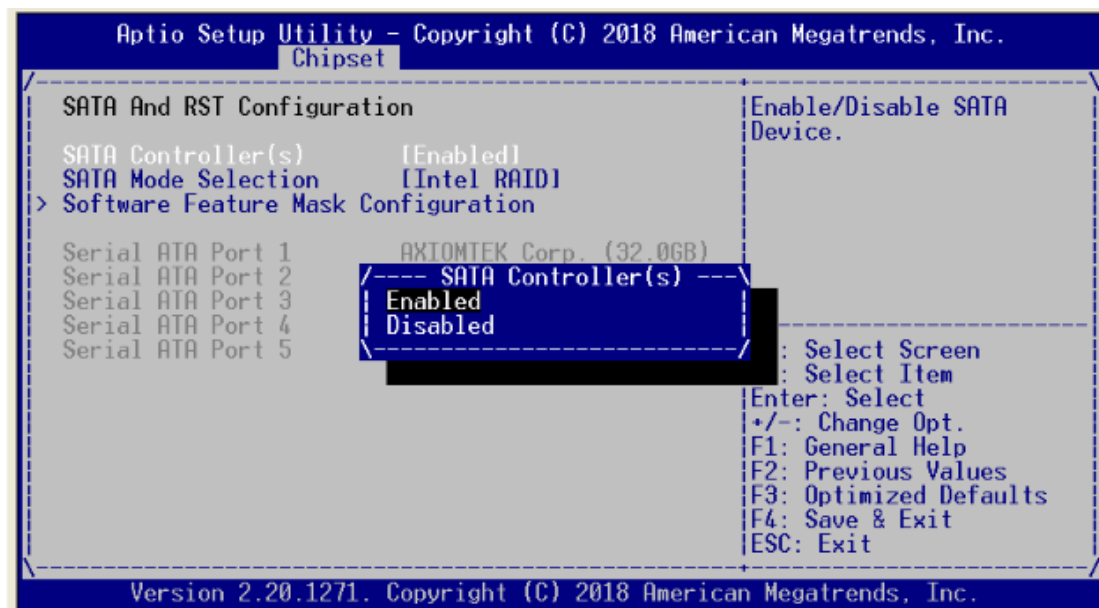
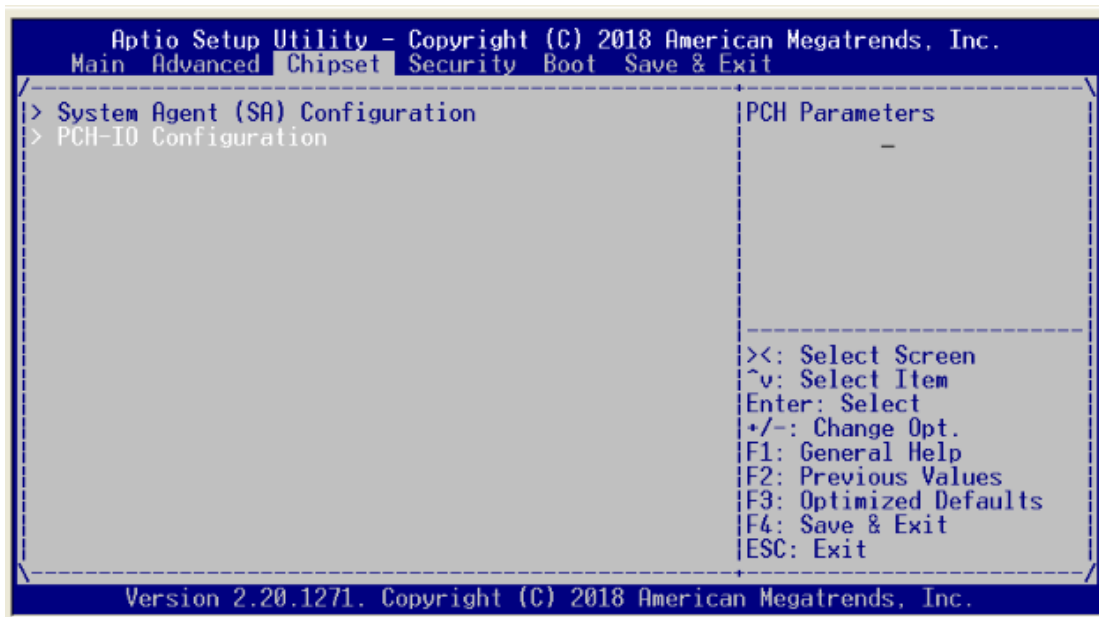

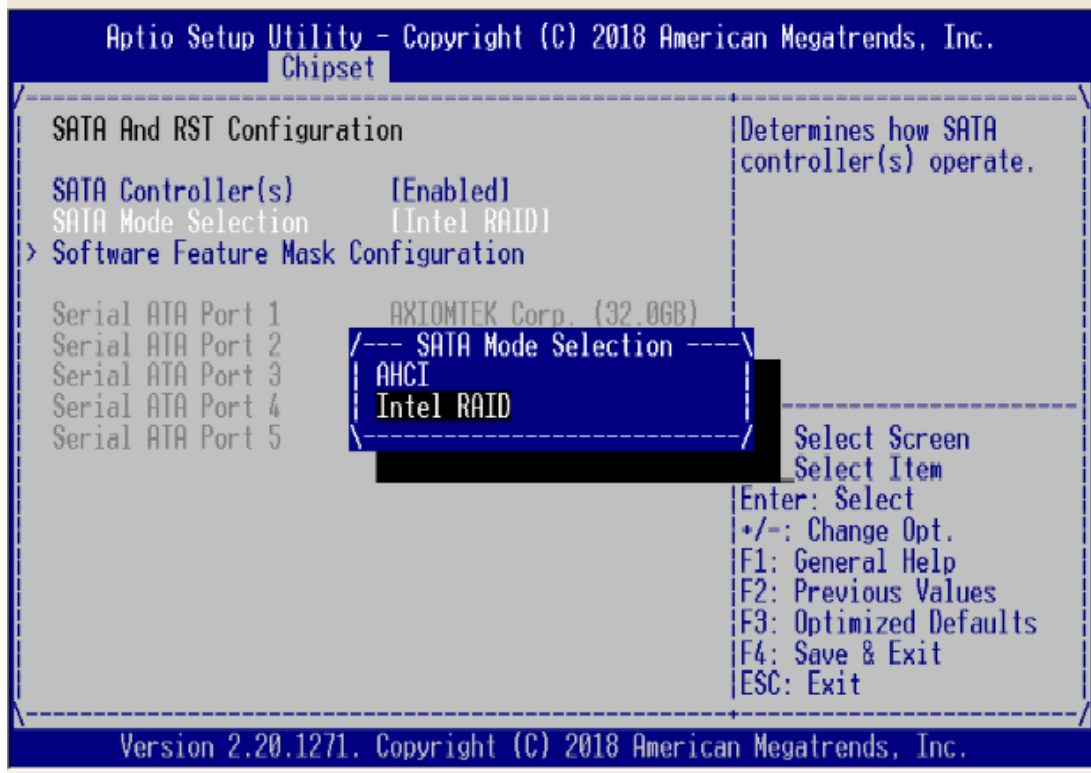

## 3.6 Security Menu

The Security menu allows users to change the security settings for the system.

- **Administrator Password**

This item indicates whether an administrator password has been set. If the password has been installed, Installed displays. If not, Not Installed displays.

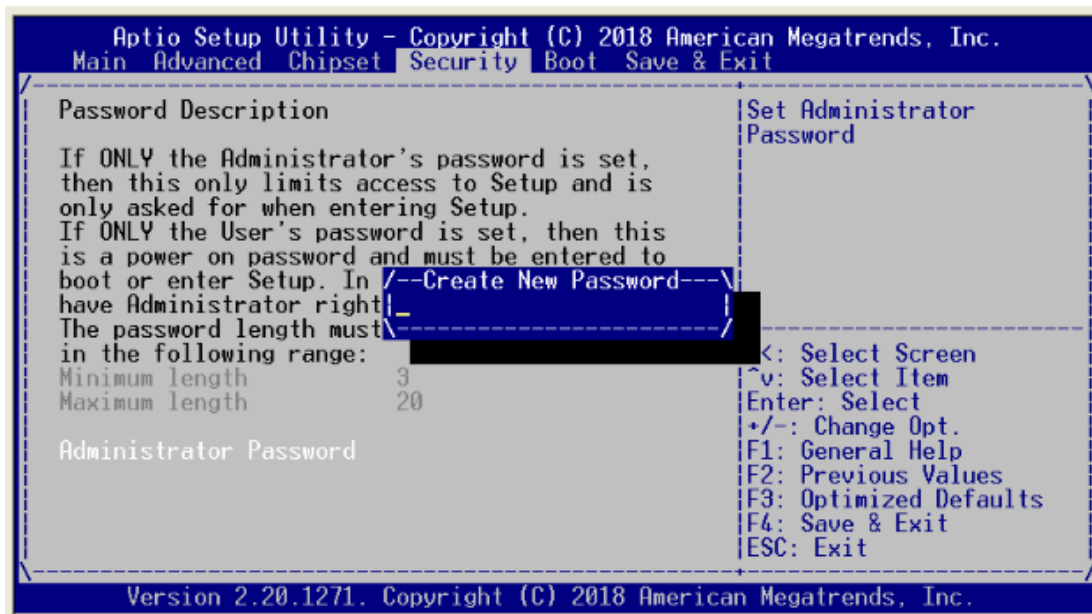

- **User Password**

This item indicates whether a user password has been set. If the password has been installed, Installed displays. If not, Not Installed displays.



## 3.7 Boot Menu

The Boot menu allows users to change boot options of the system.

- **Setup Prompt Timeout**

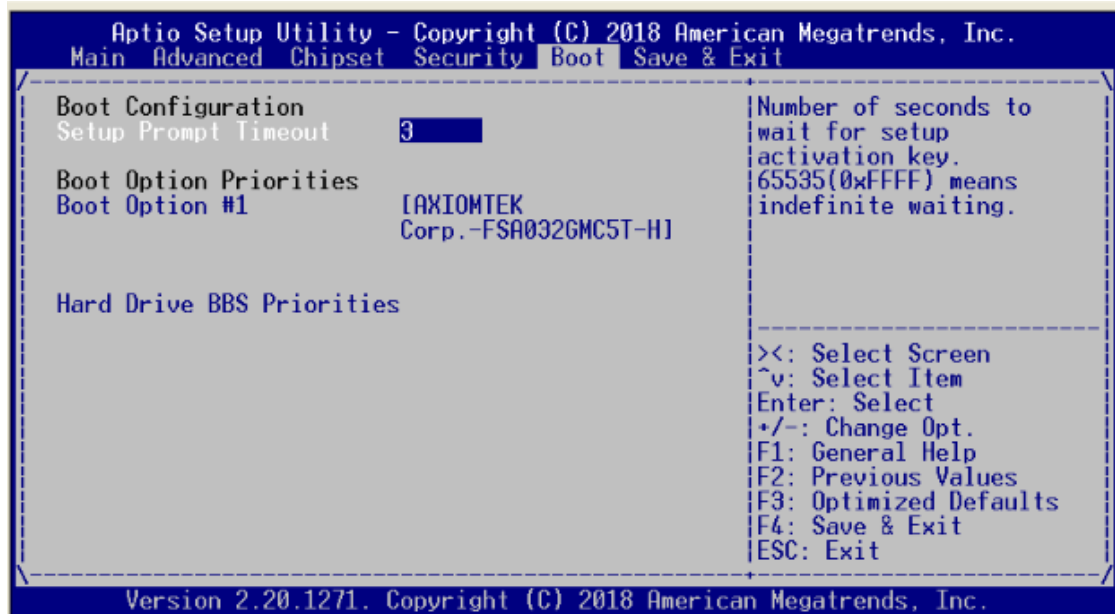

### 3.8 Save & Exit Menu

The Save & Exit menu allows users to load your system configuration with optimal or fail-safe default values.

- **Save Changes and Exit**

When you have completed the system configuration changes, select this option to leave Setup and return to Main Menu. Select Save Changes and Exit from the Save & Exit menu and press <Enter>. Select Yes to save changes and exit.

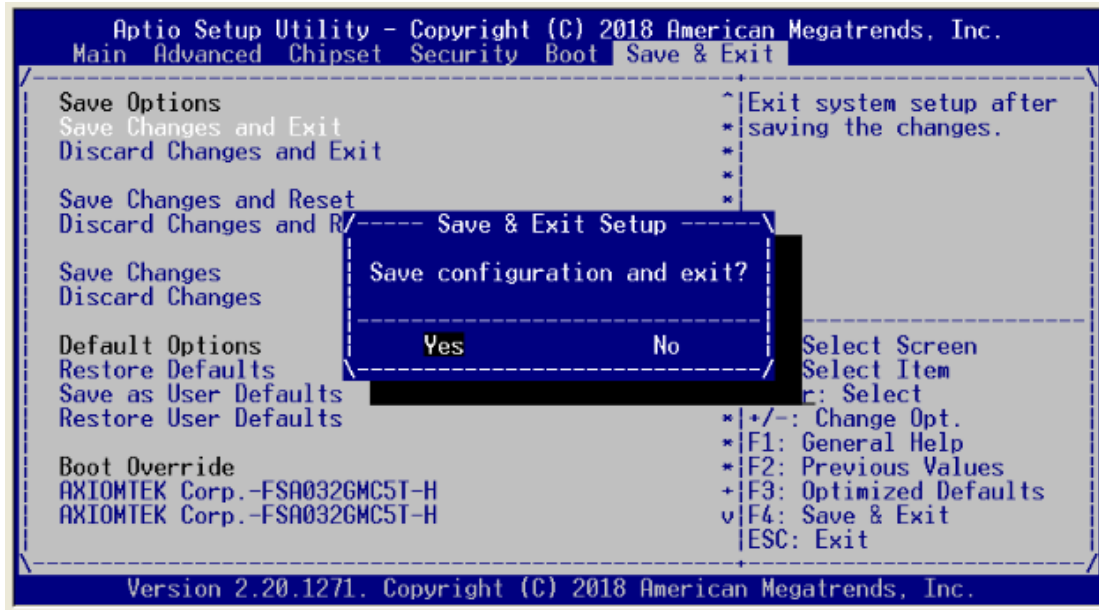

● **Discard Changes and Exit**

Select this option to quit Setup without making any permanent changes to the system configuration and return to Main Menu. Select Discard Changes and Exit from the Save & Exit menu and press <Enter>. Select Yes to discard changes and exit.

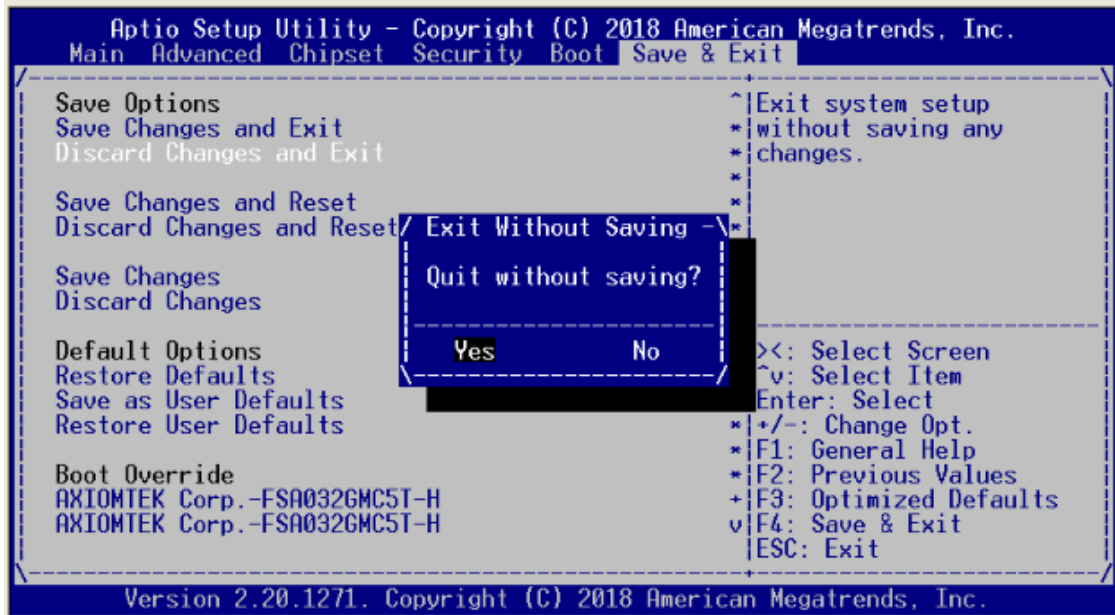

● **Save Changes and Reset**

When you have completed the system configuration changes, select this option to leave Setup and reboot the computer so the new system configuration parameters can take effect. Select Save Changes and Reset from the Save & Exit menu and press <Enter>. Select Yes to save changes and reset.

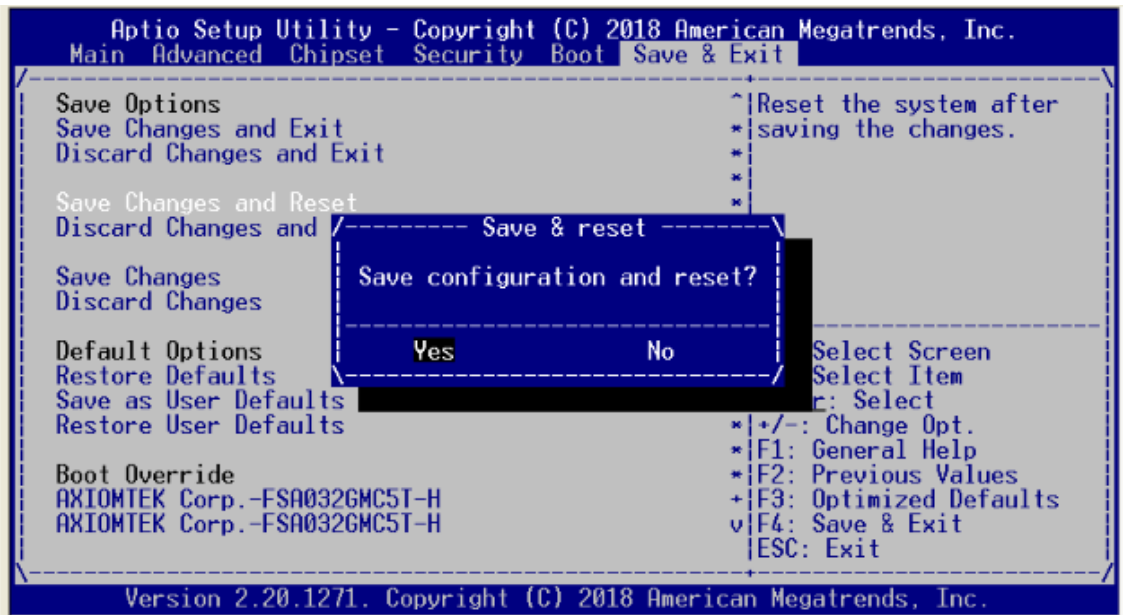

● **Discard Changes and Reset**

Select this option to quit Setup without making any permanent changes to the system configuration and reboot the computer. Select Discard Changes and Reset from the Save & Exit menu and press <Enter>. Select Yes to discard changes and reset.

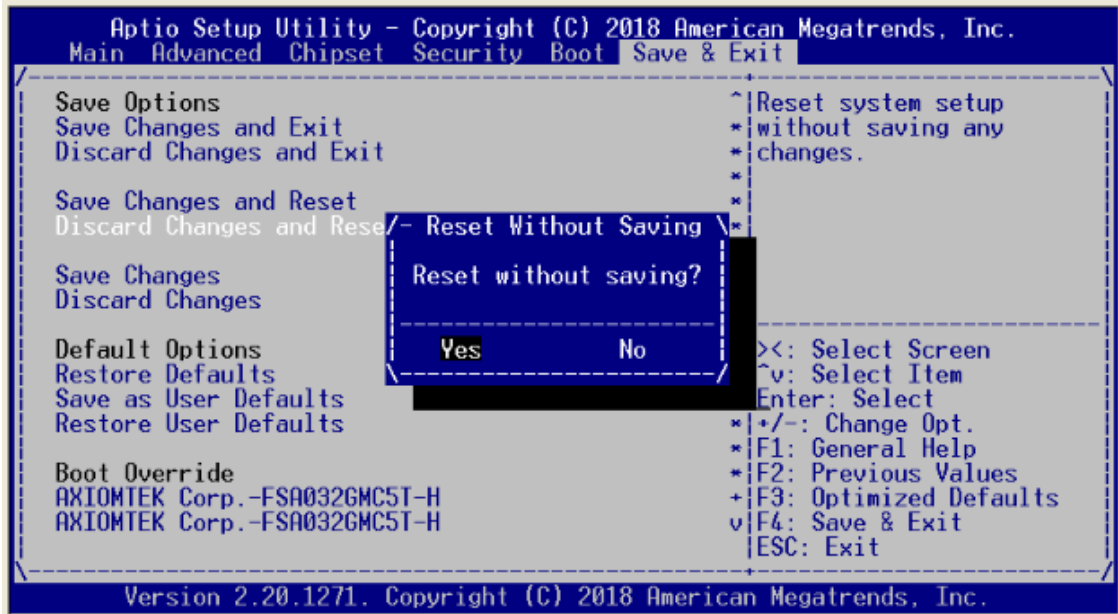

● **Save Changes**

When you have completed the system configuration changes, select this option to save changes. Select Save Changes from the Save & Exit menu and press <Enter>. Select Yes to save changes.

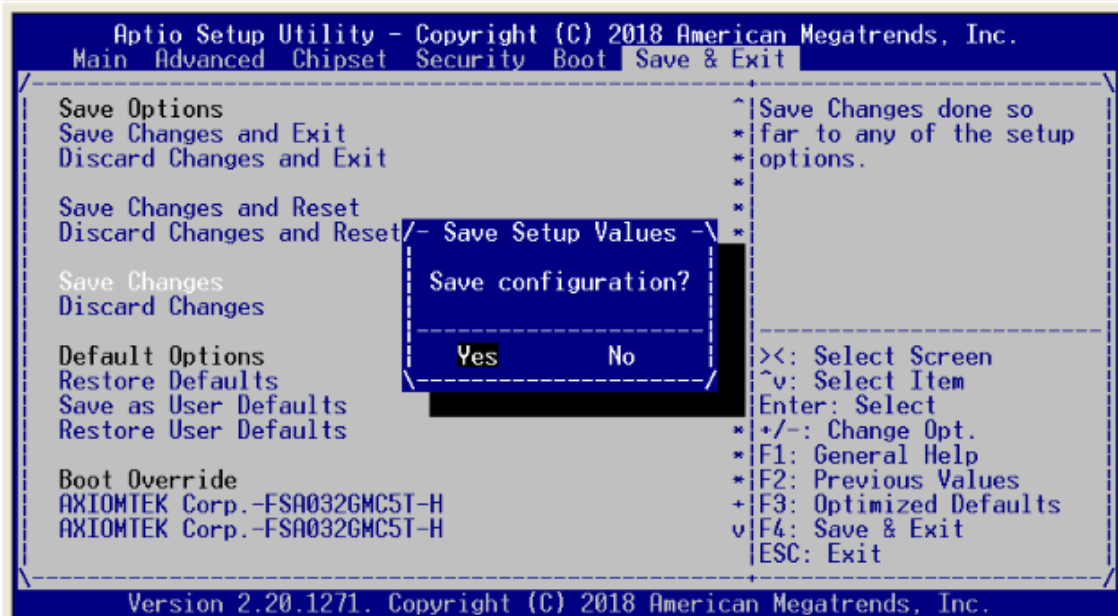

● **Discard Changes**

Select this option to quit Setup without making any permanent changes to the system configuration. Select Discard Changes from the Save & Exit menu and press <Enter>. Select Yes to discard changes.

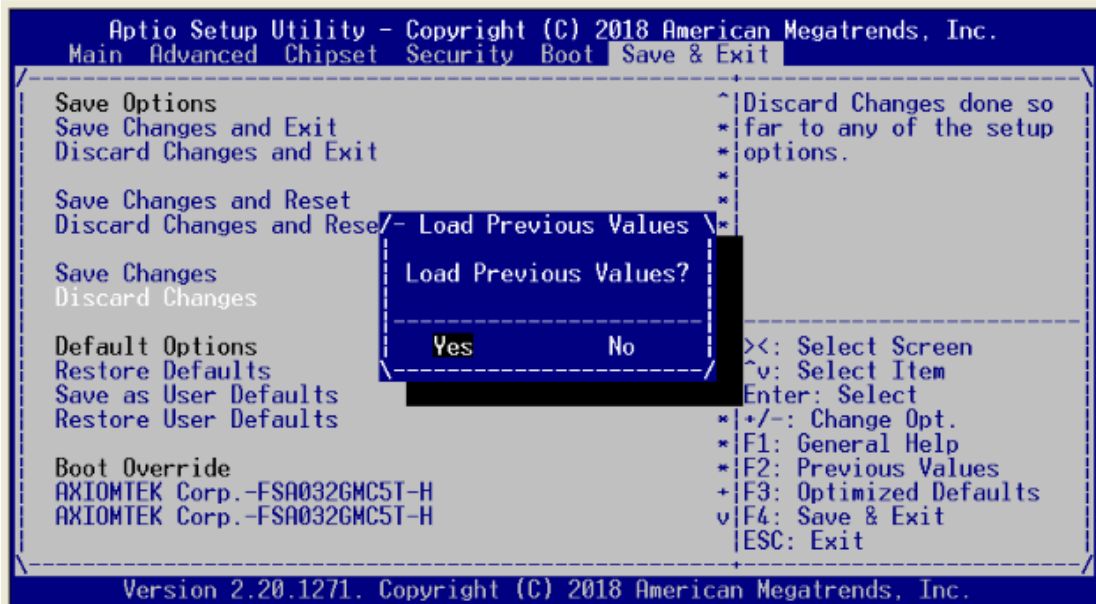

● **Restore Defaults**

It automatically sets all Setup options to a complete set of default settings when you select this option. The Optimal settings are designed for maximum system performance, but may not work best for all computer applications. In particular, do not use the Optimal Setup options if your computer is experiencing system configuration problems. Select Restore Defaults from the Save & Exit menu and press <Enter>.

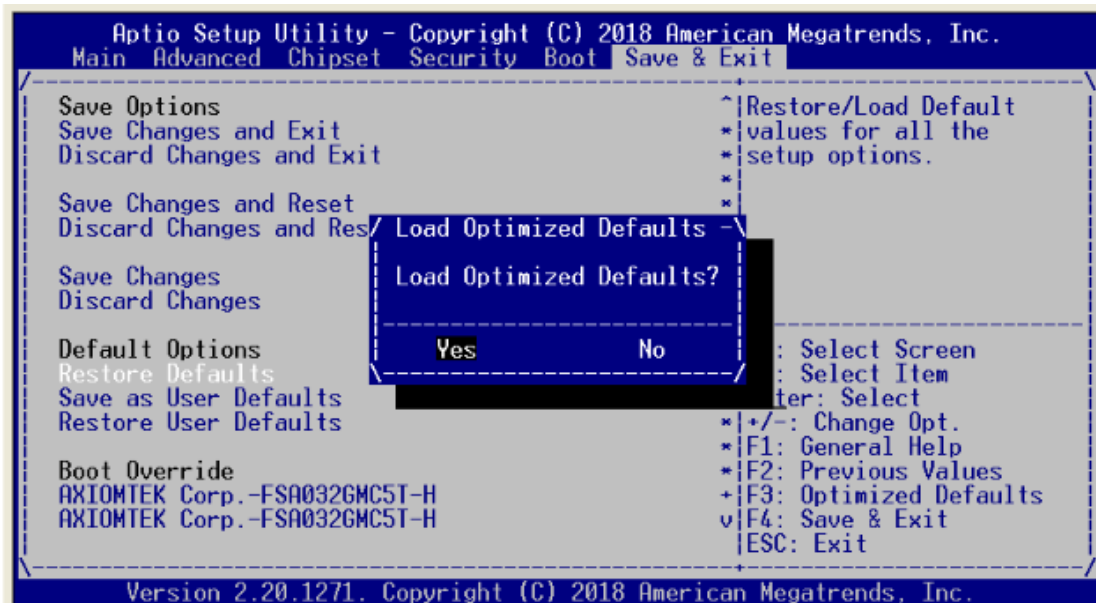

● **Save as User Defaults**

Select this option to save system configuration changes done so far as User Defaults. Select Save as User Defaults from the Save & Exit menu and press <Enter>.

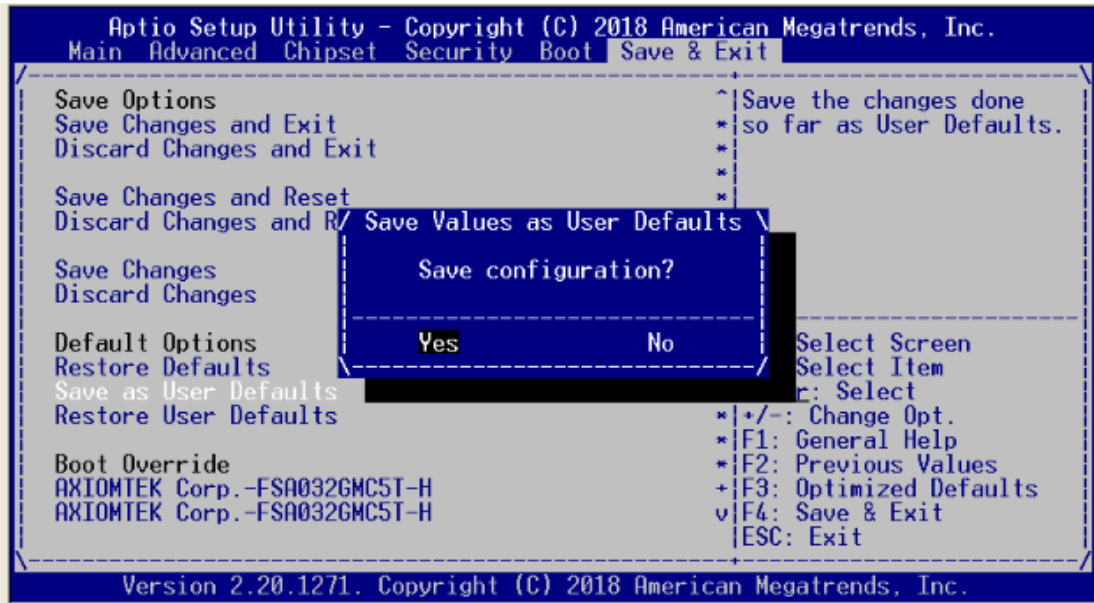

● **Restore User Defaults**

It automatically sets all Setup options to a complete set of User Defaults when you select this option. Select Restore User Defaults from the Save & Exit menu and press <Enter>.

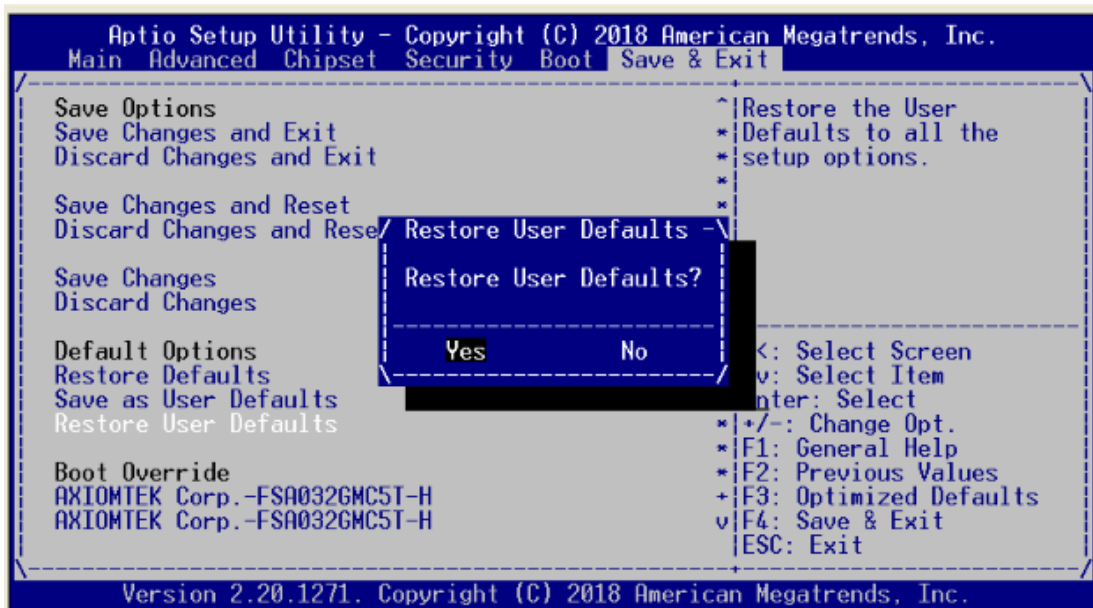

# Appendix A

## LAN Bypass Configuration

### About LAN Bypass

In network security application, it is very important to ensure that network traffic to continue passing through the device even if hardware failure occurs or operating system crashes. LAN bypass gives us a solution for this problem.

The NA590s LAN bypass function is very flexible. It can be selected at any time and any stage. You can enable LAN bypass for power on state by BIOS, or by software program when entering into the OS.

Moreover, for power off state, you can set up LAN Bypass through BIOS, or use software program when entering into the OS. If you don't do any change, the state will keep the previous power off state.

The NA590s LAN bypass capability with the special designed latch relay circuitry. When LAN bypass function is enabled, a relay closes to act as a bridge to route network data flow between LAN module's LAN port 0 and LAN port 1 (or LAN port 2 and LAN port 3 etc.). Motherboard has 2 pairs of latch-type LAN bypass LAN port 3 and LAN port 4/ LAN port 5 and LAN port 6 see below image. The bypass feature can be activated immediately or according to timer which is configurable from 1 up to 64 seconds. You can write a software program to control bypass operation behavior to fit your requirement. A LAN bypass sample program is provided on website or contact our FAE directly.

## LAN Bypass Register Configuration

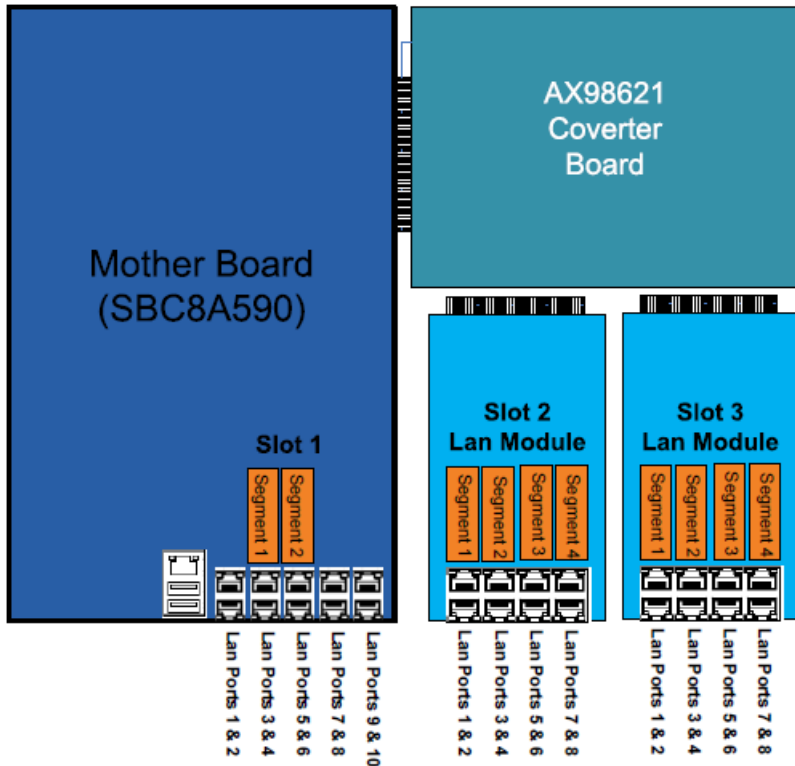

- **Power ON Bypass Control Register**

Address:

Mother board/Slot1	LAN module/Slot2	LAN module/Slot3
0x8E0	0x8E4	0x8E8

7	6	5	4	3	2	1	0
<b>BYM1</b>	<b>BYM0</b>	<b>X</b>	<b>X</b>	<b>SEGN4</b>	<b>SEGN3</b>	<b>SEGN2</b>	<b>SEGN1</b>
W	W	--	--	W	W	W	W

Default value: 00000000

Bit 7~6 BYM1~0

These bits are used to set bypass mode.

00 Not used.

01 Force bypass enable

Relay closes immediately to form LAN bypass on selected segment when power on.

10 Force bypass disable

LAN bypass is disabled immediately on selected segment when power on.



- 11 Timer enable  
When power on, the selected segments are controlled by the setting of LAN bypass Timer Control register.

Bit 5~4 Not used.

Bits 3~0 SEGN4~1

Select each segment by setting the corresponding bit to 1. When the bit is set to 0, no action happens upon the segment.

Data read back from this register is not defined and therefore must be ignored. Reading from this register makes no effect on LAN bypass function. All data in this register will be cleared when system is turned off. If you still want to use power on LAN bypass function, turn on the system and make sure to rewrite the register. Otherwise, if you don't rewrite the register, the status will be kept on power off bypass state.

- **Power OFF Bypass Control Register**

Address:

Mother board/Slot1	LAN module/Slot2	LAN module/Slot3
0x8E1	0x8E5	0x8E9

7	6	5	4	3	2	1	0
X	X	X	X	SEGF4	SEGF3	SEGF2	SEGF1
--	--	--	--	W	W	W	W

Default value: 00000000

Bit 7~4 Not used.

Bits3~0 SEGF4~1

Use the corresponding bit to configure each segment. Setting the bit to 1 enables LAN bypass on the segment when power off. Clearing the bit to 0 disables LAN bypass on the segment when power off.

Data read back from this register is not defined and therefore must be ignored. Reading from this register makes no effect on LAN bypass function. When system is turned off, last data written onto this register will be kept. If you want to make any change, turn on the system and make sure to reconfigure the register.

- **LAN Bypass Timer Control Register**

Address:

Mother board/Slot1	LAN module/Slot2	LAN module/Slot3
0x8E2	0x8E6	0x8EA

7	6	5	4	3	2	1	0
TEXP	X	X	X	X	TVAL2	TVAL1	TVAL0
R	--	--	--	--	W	W	W

Default value: 00000000

Bit 7      TEXP (Read Only)  
 This bit indicates status of hardware timer.  
 0          Timer has not expired  
 1          Timer has expired

Bits 6~3   Not used.

Bits 2~0   TVAL2~0  
 These bits determine the amount of count value in second(s).  
 001      1 (sec)  
 010      2 (sec)  
 011      4 (sec)  
 100      8 (sec)  
 101      16 (sec)  
 110      32 (sec)  
 111      64 (sec)  
 000      Timer is not activated.

Writing a value to these bits will reset the hardware timer. The counting process begins again according to the new written value. Software must write count value periodically to ensure that timer will never expire. If timer timeout occurs, relay(s) automatically close to form LAN bypass on selected segment(s) based on the setting of Power On Bypass Control register (SEGN4~SEGN1).

Data (bits 6~0) read back from this register is not defined and therefore must be ignored. A read operation upon this register should not refresh the hardware timer.

- **LAN Bypass Status / Firmware Version Register**

Address:

Mother board/Slot1	LAN module/Slot2	LAN module/Slot3
0x8E3	0x8E7	0x8EB

7	6	5	4	3	2	1	0
VER3	VER2	VER1	VER0	BY4	BY3	BY2	BY1
R	R	R	R	R	R	R	R

Bit3~0      Lan Bypass Seg.1 status → Disable=0; Enable=1  
 Bit 7~4      Firmware version  
 Without LAN bypass function=1111

# Appendix B

## WDT Timer for System Reset

WDT (Watchdog Timer)

The hardware supports the WDT (Watchdog Timer) function. While time-out happens after a defaulted period, the WDT will reset the system.



**Note:** *The sample codes for the above features can be found in the CD, and they are only for customers' reference as remarked.*

**This page is intentionally left blank.**

# Appendix C

## LAN Module Expansion







You can install LAN module(s) into NA720's front-accessible expansion slots to meet your application requirement. Here are some LAN module configurations for your selection:

- LAN Modules

Slim Module	Ports	Chipset	Bypass	NA720
<b>GbE Copper Modules</b>				
AX93316-8GI	8	Intel 82580EB	0	v
AX93316-8GIL	8	Intel 82580EB	4	v
AX93336-4GI	4	Intel i210AT	2	v
AX93336-4GIL	4	Intel i350	2	v
<b>GbE Fiber Modules</b>				
AX93322-8FI	8	Intel 82580EB	0	v
AX93322-8MIL	4+4	Intel 82580EB	2	v
AX93336-4FI	4	Intel i350	0	v
<b>10GbE Copper Modules</b>				
AX93317-2GIL	2	Intel X540	1	v
<b>10GbE Fiber Modules</b>				
AX93307-2FI	2	Intel 82599ES	0	v
AX93307-2FIL	2	Intel 82599ES	1	v
AX93327-4FI	4	Intel XL710	0	v

### LAN Bypass Control Jumper (JP2/JP3)

Use this jumper to select the LAN Bypass Function.

Description	Function	Jumper
LAN Bypass Trigger when Power On	All SEG. Bypass as same as Power Off status	<p><b>JP3</b></p>  <p><b>JP2</b></p> 
	All SEG Bypass Disable(Default)	<p><b>JP3</b></p>  <p><b>JP2</b></p> 
	All SEG Bypass Enable	<p><b>JP3</b></p>  <p><b>JP2</b></p> 



**Note:** When the system is turned on, you can select LAN bypass function by Jumper and Bios when power on state, when enter the OS, you can select LAN bypass function at power on/ off state by software ,the detail information please refer to the appendix A.

## LED Definition

AX93316



### LAN bypass LED

- **LAN bypass LED**  
While running the LAN By-Pass function, the LED always lights up.
- **Active LED (Single color)for LAN port #1, port#2, port#3, port#4, port #5, port#6, port#7, port#8**
  - The orange LED is on when the LAN port connection is working.
  - The LED flashes when transmitting or receiving any signals to or from the appliance.
  - The LED is dark when the appliance is off.
- **Link LED for LAN port #1, port#2, port#3, port#4, port#5 and port#6, port#7, port#8**
  - The double-color LED light indicates 10/100/1000Mbps transfer rate.
  - When the orange-color LED light is radiating, it should be 1000Mbps transfer rate.
  - When the green-color LED light is radiating, it should be 100Mbps transfer rate.
  - If the Link LED is dark and Active LED is light on or flashing, it should be 10Mbps transfer rate.

When this LED and Link / Active LED both are dark. No networking devices are attached

Transfer Rate	LED Light Color
10Mbps	Dark
100Mbps	Green
1000Mbps	Orange

**AX93336-4GIL**

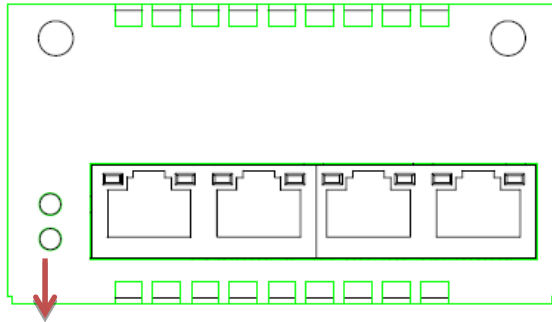

**LAN bypass LED**

- **LAN bypass LED**  
While running the LAN By-Pass function, the LED always lights up.
- **Active LED (Single color) for LAN port #1, port#2, port#3, port#4**
  - The orange LED is on when the LAN port connection is working.
  - The LED flashes when transmitting or receiving any signals to or from the appliance.
  - The LED is dark when the appliance is off.
- **Link LED for LAN port #1, port#2, port#3, port#4**
  - The double-color LED light indicates 10/100/1000Mbps transfer rate.
  - When the orange-color LED light is radiating, it should be 1000Mbps transfer rate.
  - When the green-color LED light is radiating, it should be 100Mbps transfer rate.
  - If the Link LED is dark and Active LED is light on or flashing, it should be 10Mbps transfer rate.

When this LED and Link/Active LED both are dark. No networking devices are attached

Transfer Rate	LED Light Color
10Mbps	Dark
100Mbps	Green
1000Mbps	Orange

**AX93336-4FI**

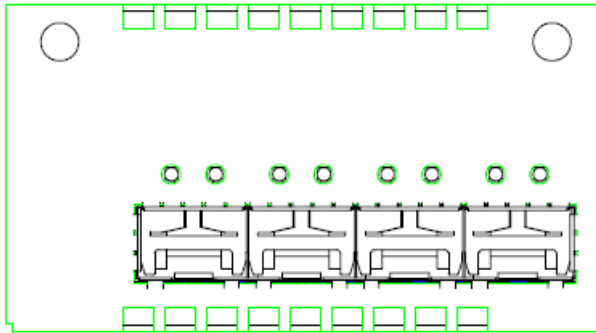

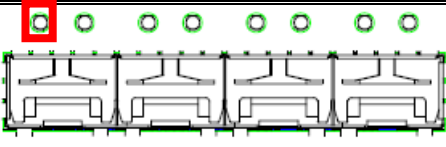
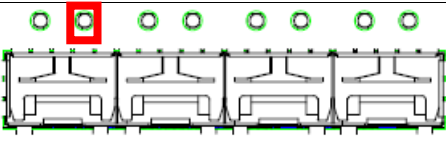

Transfer Rate	LED Light Color
 <p>The diagram shows the top-down view of the fiber port array. The first LED indicator on the left is highlighted with a red square, while the other three LEDs are highlighted with green circles.</p>	<p>Fiber port Active: Orange</p>
 <p>The diagram shows the top-down view of the fiber port array. The second LED indicator from the left is highlighted with a red square, while the other three LEDs are highlighted with green circles.</p>	<p>Fiber port Link: Orange</p>

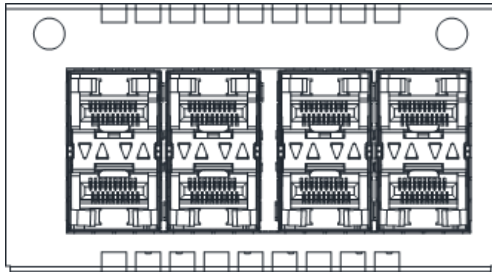

AX93322-8FI

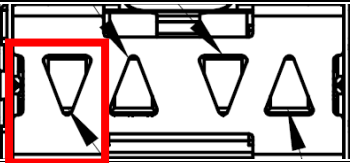
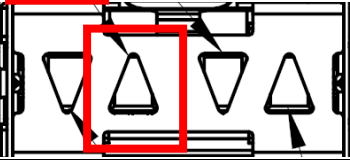

Transfer Rate	LED Light Color
	Down Fiber port Active: Orange
	Up Fiber port Active: Orange
	Down Fiber port Link: Orange
	Up Fiber port Link: Orange

**AX93322-8MIL**



**LAN bypass LED**

**FIBER:**

Transfer Rate	LED Light Color
	Down Fiber port Active: Orange
	Up Fiber port Active: Orange
	Down Fiber port Link: Orange
	Up Fiber port Link: Orange

**Copper:**

- **LAN bypass LED**  
While running the LAN By-Pass function, the LED always lights up.
- **Active LED (Single color) for LAN port #1, port#2, port#3, port#4**
  - The orange LED is on when the LAN port connection is working.
  - The LED flashes when transmitting or receiving any signals to or from the appliance.
  - The LED is dark when the appliance is off.
- **Link LED for LAN port #1, port#2, port#3, port#4**
  - The double-color LED light indicates 10/100/1000Mbps transfer rate.
  - When the orange-color LED light is radiating, it should be 1000Mbps transfer rate.
  - When the green-color LED light is radiating, it should be 100Mbps transfer rate.
  - If the Link LED is dark and Active LED is light on or flashing, it should be 10Mbps transfer rate.

When this LED and Link / Active LED both are dark. No networking devices are attached

Transfer Rate	LED Light Color
10Mbps	Dark
100Mbps	Green
1000Mbps	Orange

**AX93317**

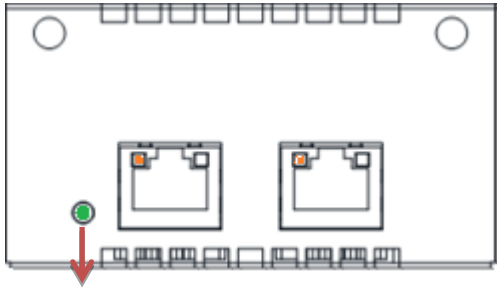

**LAN bypass LED**

- **LAN bypass LED**  
While running the LAN By-Pass function, the LED always lights up.
- **Active LED (Single color) for LAN port #1, port#2**
  - The orange LED is on when the LAN port connection is working.
  - The LED flashes when transmitting or receiving any signals to or from the appliance.
  - The LED is dark when the appliance is off.
- **Link LED for LAN port #1, port#2**
  - The double-color LED light indicates 1000/10000Mbps transfer rate.
  - When the orange-color LED light is radiating, it should be 10000Mbps transfer rate.
  - When the green-color LED light is radiating, it should be 1000Mbps transfer rate.

When this LED and Link/Active LED both are dark. No networking devices are attached

Transfer Rate	LED Light Color
1000Mbps	Green
10000Mbps	Orange

**AX93307**

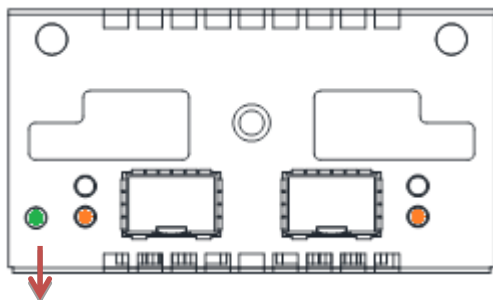

**LAN bypass LED**

- **LAN bypass LED**  
While running the LAN By-Pass function, the LED always lights up.
- **Active LED (Single color)for LAN port #1, port#2**
  - The orange LED is on when the LAN port connection is working.
  - The LED flashes when transmitting or receiving any signals to or from the appliance.
  - The LED is dark when the appliance is off.
- **Link LED for LAN port #1, port#2**
  - The double-color LED light indicates 1000/10000Mbps transfer rate.
  - When the orange-color LED light is radiating, it should be 10000Mbps transfer rate.
  - When the green-color LED light is radiating, it should be 1000Mbps transfer rate.

Transfer Rate	LED Light Color
1000Mbps	Green
10000Mbps	Orange

# Appendix D

## Warning

- This is a class A Product. In a domestic Environment this Product may cause radio interference in which case the user may be required to take adequate measures.

- It will be danger if battery is incorrectly replaced. Replacing only with the same or equivalent type is highly recommended by the manufacturer. Dispose of used batteries according to the manufacturer's instructions.

- **Warning for Hard Disk Drive Selection:**  
TUV approved Hard Disk Drive is preferred for TUV compliance Hard Disk drive-Optional, (NWGQ2), generic, Input Voltage rated 5V DC/1.0A, 12V DC/1.8A maximum. Minimum clearance from uninsulated live parts 4.0 mm.

- The equipment is to be installed in an environment with maximum ambient temperature must not exceed 40°C
- The openings on the enclosure are for air convection hence protected the equipment from overheating. DO NOT COVER THE OPENINGS.
- Lay this equipment on a reliable surface when install. A drop or fall could cause injury.
- The equipment shall be installed according to specification as nameplate. Make sure the voltage of the power source when connect the equipment to the power outlet.
- The current of load and output power of loads shall be not over the specification.
- This equipment must be connected to the reliable earthling before using.



**Electric shock hazard inside the redundant power supply.**  
The exchange of modules shall be done by service person.

**This page is intentionally left blank.**