



AXIOMTEK

MANO842 Series

**Intel® Bay Trail SoC CPU
Mini ITX Motherboard**

User's Manual



Disclaimers

This manual has been carefully checked and believed to contain accurate information. Axiomtek Co., Ltd. assumes no responsibility for any infringements of patents or any third party's rights, and any liability arising from such use.

Axiomtek does not warrant or assume any legal liability or responsibility for the accuracy, completeness or usefulness of any information in this document. Axiomtek does not make any commitment to update the information in this manual.

Axiomtek reserves the right to change or revise this document and/or product at any time without notice.

No part of this document may be reproduced, stored in a retrieval system, or transmitted, in any form or by any means, electronic, mechanical, photocopying, recording, or otherwise, without the prior written permission of Axiomtek Co., Ltd.

CAUTION

If you replace wrong batteries, it causes the danger of explosion. It is recommended by the manufacturer that you follow the manufacturer's instructions to only replace the same or equivalent type of battery, and dispose of used ones.

©Copyright 2016 Axiomtek Co., Ltd.

All Rights Reserved

Feb 2016, Version A2

Printed in Taiwan

ESD Precautions

Computer boards have integrated circuits sensitive to static electricity. To prevent chipsets from electrostatic discharge damage, please take care of the following jobs with precautions:

- Do not remove boards or integrated circuits from their anti-static packaging until you are ready to install them.
- Before holding the board or integrated circuit, touch an unpainted portion of the system unit chassis for a few seconds. It discharges static electricity from your body.
- Wear a wrist-grounding strap, available from most electronic component stores, when handling boards and components.

Trademarks Acknowledgments

Axiomtek is a trademark of Axiomtek Co., Ltd.

Windows® is a trademark of Microsoft Corporation.

AMI is a trademark of American Megatrend Inc.

IBM, PC/AT, PS/2, VGA are trademarks of International Business Machines Corporation.

Intel® and Celeron® are trademarks of Intel Corporation.

Other brand names and trademarks are the properties and registered brands of their respective owners.

Table of Contents

Disclaimers	ii
ESD Precautions.....	iii
Chapter 1 Introduction.....	1
1.1 Features.....	1
1.2 Specifications	2
1.3 Utilities Supported	3
1.4 Block Diagram.....	4
Chapter 2 Board and Pin Assignments.....	5
2.1 Board Layout.....	5
2.2 Rear I/O.....	6
2.3 Jumper Settings	7
2.3.1 Clear CMOS Select (JP1)	8
2.3.2 LVDS VDD Select (JP2)	8
2.3.3 LVDS Backlight PWM/CCFL Select (JP3).....	9
2.3.4 AT/ATX Power Mode Select (JP4)	9
2.3.5 COM1 RS-232/422/485 Mode Select (JP5, JP6, JP7)	9
2.3.6 COM2 RS-232/422/485 Mode Select (JP8, JP9, JP10)	9
2.3.7 COM3 Data/Power Select (JP11).....	10
2.4 Connectors.....	11
2.4.1 Internal USB Header (CN3)	12
2.4.2 SATA Connectors (CN4).....	12
2.4.3 SIM Card Slot (CN5)	12
2.4.4 VGA Connector (CN8).....	13
2.4.5 LVDS Signal Header (CN9).....	13
2.4.6 LVDS Backlight Control Header (CN10)	14
2.4.7 DC12V Power Input Connector 1 (CN12)	14
2.4.8 Power Status Header (CN13).....	14
2.4.9 Front Panel Header (CN14)	15
2.4.10 DC12V/5V Power Output Connector (CN15).....	15
2.4.11 PS/2 Keyboard and Mouse Connector (CN16)	15
2.4.12 GPIO Header (CN17)	16
2.4.13 COM Connector (CN18).....	16
2.4.14 COM Headers (CN19~CN22)	17
2.4.15 LAN and USB Connectors (CN24 and CN25)	17
2.4.16 PCI-Express x1 Slot (CN26)	18
2.4.17 Full-size PCI-Express Mini Card Connector (CN27)	19
2.4.18 mSATA Slot (CN28).....	19

2.4.19	HDMI Connector (CN29)	19
2.4.20	Audio Jack (CN30)	20
2.4.21	Front Audio Header (CN31)	20
2.4.22	Fan Connectors (CN33 and CN34)	20

Chapter 3 Hardware Description 21

3.1	Microprocessors	21
3.2	BIOS	21
3.3	System Memory	21

Chapter 4 AMI BIOS Setup Utility 23

4.1	Starting	23
4.2	Navigation Keys	23
4.3	Main Menu	25
4.4	Advanced Menu	26
4.5	Chipset Menu	40
4.6	Security Menu	42
4.7	Boot Menu	43
4.8	Save & Exit Menu	44

This page is intentionally left blank.

Chapter 1

Introduction

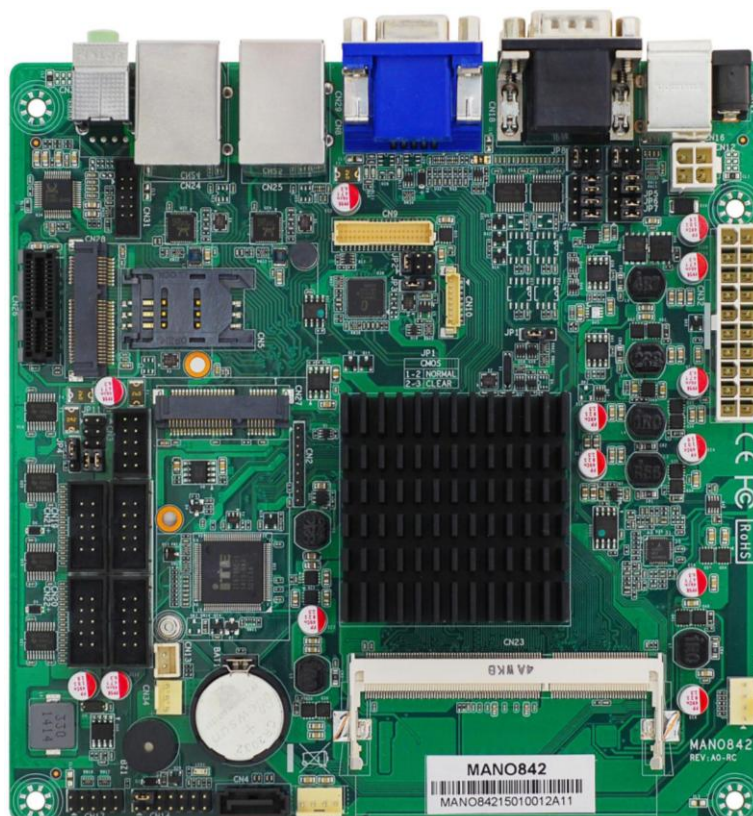

The MANO842 is a Mini ITX board based on Intel® Celeron® J1900 processor. It delivers outstanding system performance through high-bandwidth interfaces, multiple I/O functions for interactive applications and various embedded computing solutions. There is one 204-pin DDR3L SO-DIMM for DDR3L 1333MHz memory with maximum capacity up to 8GB. This Mini ITX board features two Gigabit Ethernet ports, one SATA 2.0 port with maximum transfer rate up to 3Gb/s, one USB 3.0 and five USB 2.0 high speed compliant ports that can achieve the best stability and reliability for industrial applications.

1.1 Features

- Intel® Celeron® J1900 processor
- 1 DDR3L 1333MHz max. up to 8GB memory capacity
- 1 PCI-Express x1
- 1 PCI-Express Mini Card
- 1 SATA-300
- 1 mSATA
- 1 USB 3.0 and 5 USB 2.0 ports
- Dual view display
- Display: HDMI/VGA/LVDS

1.2 Specifications

- **CPU**
 - Intel® Celeron® quad core J1900.
- **BIOS**
 - AMI BIOS via SPI interface with socket.
- **System Memory**
 - One 204-pin SO-DIMM socket.
 - Maximum up to 8GB DDR3L memory.
 - Support 1333MHz memory.
- **Onboard Multi I/O**
 - Controller: IT8786.
 - One PS/2 keyboard and mouse on the rear I/O.
 - Six serial ports:
 - COM1~COM2 support RS-232/422/485; COM3~COM6 support RS-232 only.
 - COM1~COM2 on the rear I/O; COM3~COM6 in box headers.
- **USB Interface**
 - One USB 3.0 port (on the rear I/O).
 - Five USB 2.0 ports (3 on the rear I/O and 2 in box headers).
- **Ethernet**
 - Two Realtek GbE LAN ports.
 - Support 1000/100/10Mbps Gigabit/Fast Ethernet.
- **Serial ATA**
 - One SATA 2.0 port (3Gb/s).
 - One mSATA slot; only support mSATA.
- **Audio**
 - Realtek ALC662 5.1 channel HDA codec.
 - Support line-out/MIC-in.
- **Display**
 - One 15-pin D-Sub as VGA connector. Resolution max. up to 1920x1200.
 - One HDMI with resolution max. up to 1920x1200.
 - One 24-bit dual channel LVDS and one 8-pin inverter connector. LVDS resolution is max. up to 1920x1200.
- **Expansion Interface**
 - One PCI-Express x1 slot.
 - One PCI-Express Mini Card; only support WIFI and 3G.
 - One SIM card slot.
- **Power Input**
 - One ATX power input connector.
 - Two DC12V power input connector.
- **Operating Temperature**
 - 0~60°C.
- **Storage Temperature**
 - -20~60°C.

- **Form Factor**
 - Mini ITX (6.7" x 6.7", 17.0cm x 17.0cm).



Note

All specifications and images are subject to change without notice.

1.3 Utilities Supported

- Chipset driver
- Ethernet driver
- Graphics driver
- Audio driver

1.4 Block Diagram

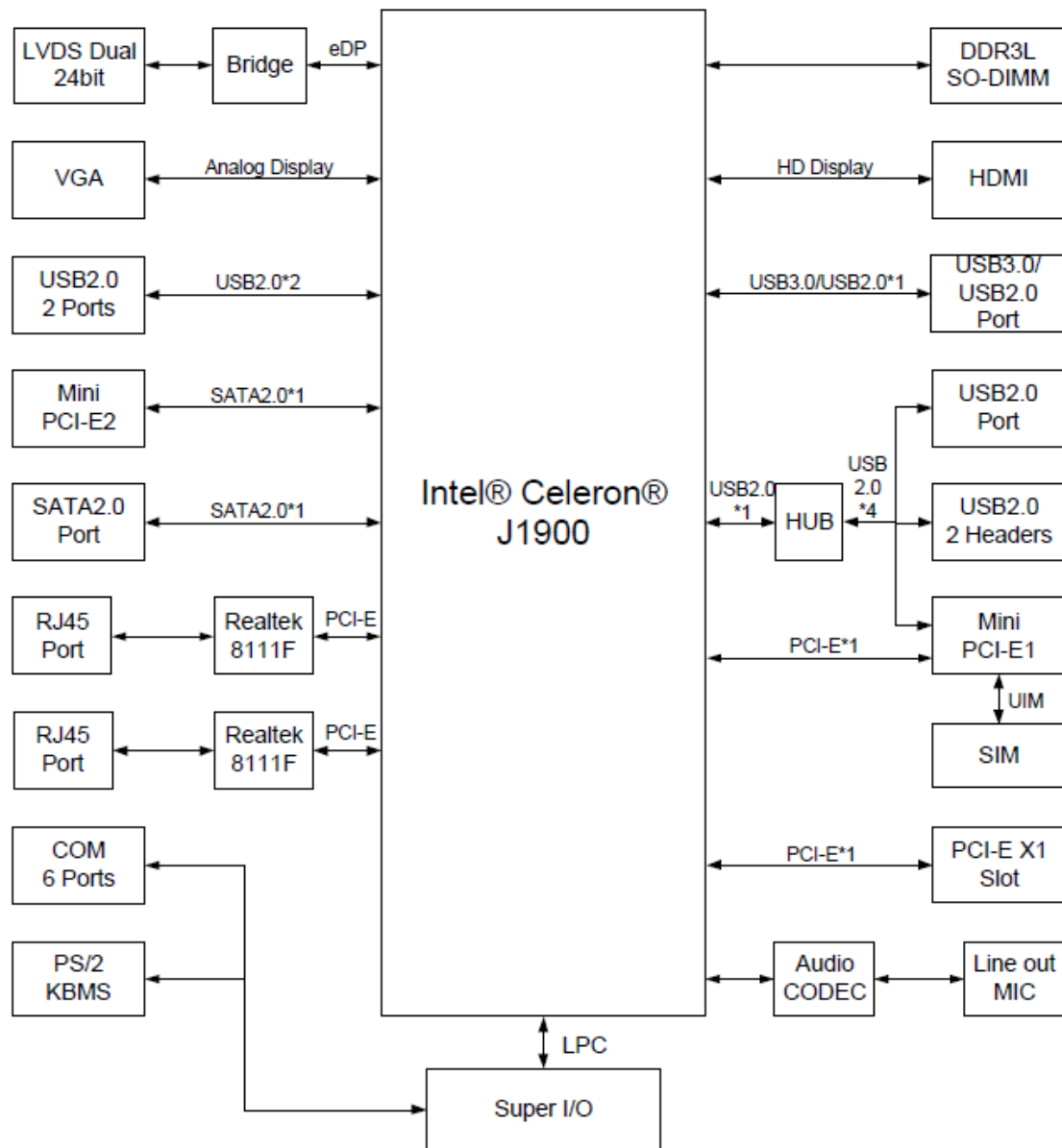

Chapter 2

Board and Pin Assignments

2.1 Board Layout

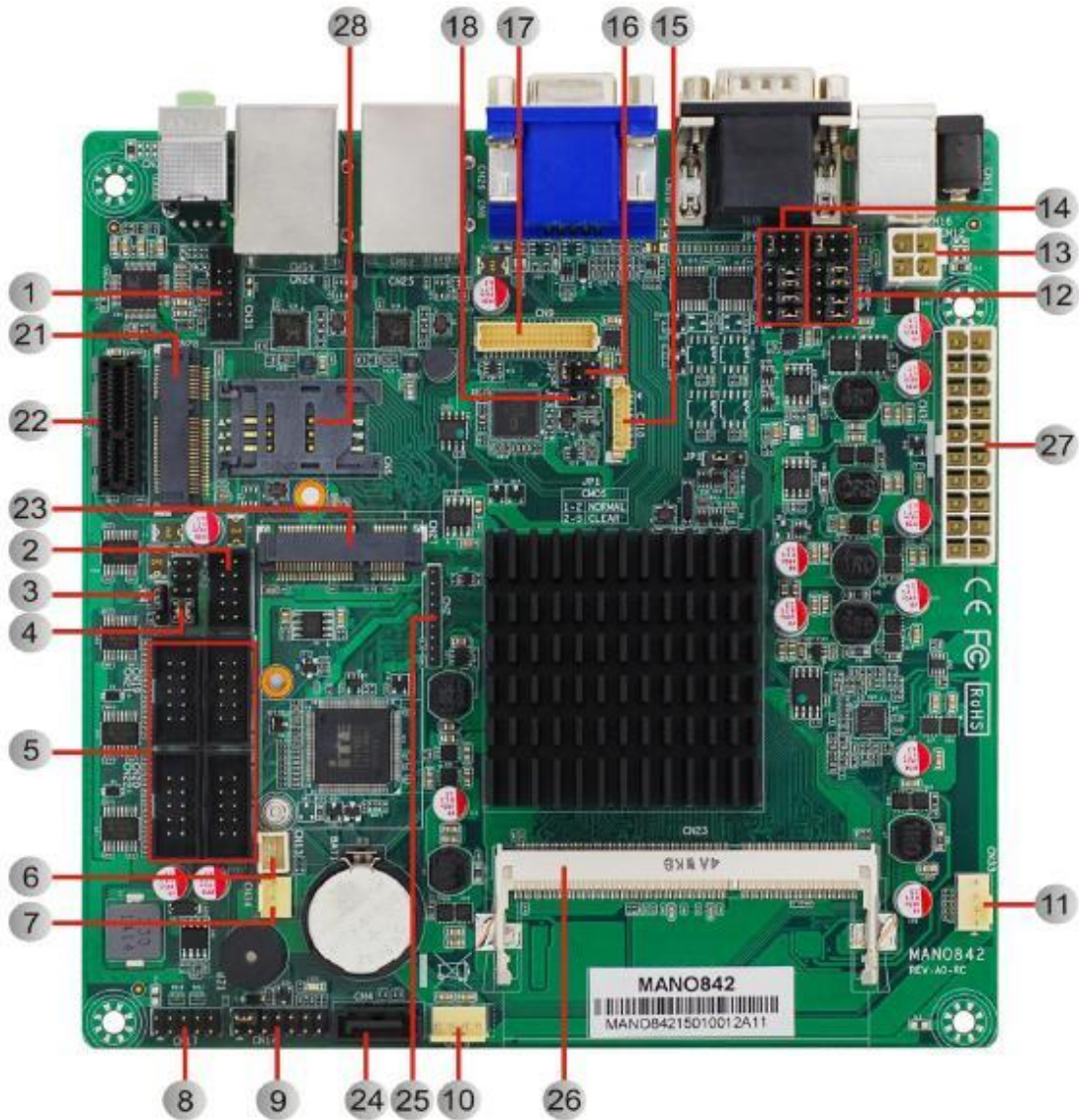

2.2 Rear I/O

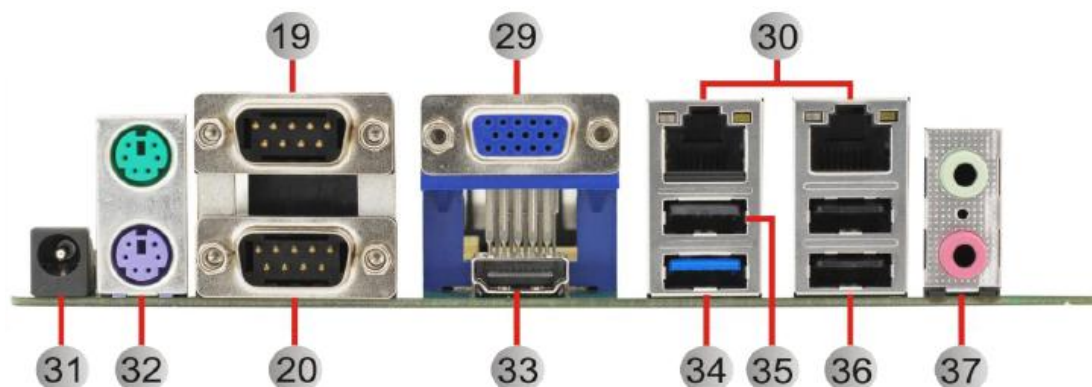

1	Front Audio Header (CN31)	20	COM2 Connector (CN18)
2	Internal USB Header (CN3)	21	mSATA Slot (CN28)
3	AT/ATX Power Mode Select Jumper (JP4)	22	PCI-Express x1 Slot (CN26)
4	COM3 Data/Power Select Jumper (JP11)	23	PCI-Express Mini Card Connector (CN27)
5	COM3~COM6 Headers (CN19~CN22)	24	SATA 2.0 Connector (CN4)
6	Power Status Header (CN13)	25	Debug Header (CN2)
7	Fan2 Connector (CN34)	26	DDR3L SO-DIMM Socket (CN23)
8	GPIO Header (CN17)	27	ATX Power Input Connector (CN32)
9	Front Panel Header (CN14)	28	SIM Card Slot (CN5)
10	DC12V/5V Power Output Connector (CN15)	29	VGA Connector (CN8)
11	Fan1 Connector (CN33)	30	LAN Connectors (CN24~CN25)
12	COM1 RS-232/422/485 Mode Select Jumpers (JP5~JP7)	31	DC12V Power Input Connector 2 (CN11)
13	DC12V Power Input Connector 1 (CN12)	32	PS/2 Keyboard and Mouse Connector (CN16)
14	COM2 RS-232/422/485 Mode Select Jumpers (JP8~JP10)	33	HDMI Connector (CN29)
15	LVDS Backlight Control Header (CN10)	34	USB 3.0 Connector (CN25)
16	LVDS VDD Select Jumper (JP2)	35	USB 2.0 Connector (CN25)
17	LVDS Signal Header (CN9)	36	USB 2.0 Connectors (CN24)
18	LVDS Backlight PWM/CCFL Select Jumper (JP3)	37	Audio Connector (CN30)
19	COM1 Connector (CN18)		



Note

To identify the first pin of a header or jumper, please refer to the following information:

- Usually, there is a thick line or a triangle near the header or jumper pin 1.

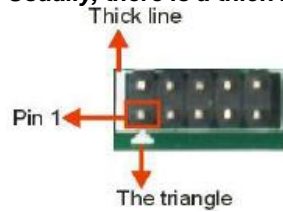

- Square pad, which you can find on the back of the motherboard, is usually used for pin 1.



2.3 Jumper Settings

Jumper is a small component consisting of jumper clip and jumper pins. Install jumper clip on 2 jumper pins to close. And remove jumper clip from 2 jumper pins to open. The following illustration shows how to set up jumper.

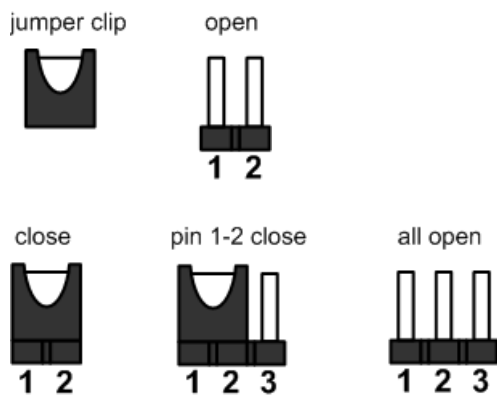

Before applying power to MANO842 Series, please make sure all of the jumpers are in factory default position. Below you can find a summary table of all jumpers and onboard default settings.



Note

Once the default jumper setting needs to be changed, please do it under power-off condition.

Jumper	Description	Setting
JP1	Clear CMOS	1-2 Close
JP2	LVDS VDD Select Default: +3.3V	1-2 Close
JP3	LVDS Backlight PWM/CCFL Select Default: PWM	1-2 Close
JP4	AT/ATX Power Mode Select Default: ATX Mode	1-2 Close
JP5	COM1 RS-232/422/485 Mode Select Default: RS-232	1-2 Close
JP6		3-5, 4-6 Close
JP7		3-5, 4-6 Close
JP8	COM2 RS-232/422/485 Mode Select Default: RS-232	1-2 Close
JP9		3-5, 4-6 Close
JP10		3-5, 4-6 Close
JP11	COM3 Data/Power Select Default: RS-232 Data	COM3 Pin 1: DCD# 7-9 Close
		COM3 Pin 8: RI# 8-10 Close

2.3.1 Clear CMOS Select (JP1)

This jumper allows you to clear the Real Time Clock (RTC) RAM in CMOS. You can clear the CMOS memory of date, time, and system setup parameters by erasing the CMOS RTC RAM data. The onboard button cell battery powers the RAM data in CMOS, which includes system setup information such as system passwords.

To erase the RTC RAM:

1. Turn OFF the computer and unplug the power cord.
2. Remove the onboard battery.
3. Move the jumper clip from pins 1-2 (default) to pins 2-3. Keep the clip on pins 2-3 for about 5~10 seconds, then move the clip back to pins 1-2.
4. Re-install the battery.
5. Plug the power cord and turn ON the computer.
6. Hold down the key during the boot process and enter BIOS setup to re-enter data.

Function	Setting
Normal operation (Default)	1-2 close
Clear CMOS	2-3 close

2.3.2 LVDS VDD Select (JP2)

This motherboard supports voltage selection for flat panel displays. Use this 3x2-pin p=2.54mm jumper to set up VDD power of the LVDS connector. To prevent hardware damage, before connecting please make sure that the input voltage of LVDS panel is correct.

Function	Setting
+3.3V (Default)	1-2 close
+5V	3-4 close
+12V	5-6 close

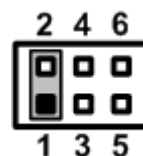

2.3.3 LVDS Backlight PWM/CCFL Select (JP3)

This 3x1-pin p=2.54mm jumper enables you to select PWM or voltage control mode for LVDS backlight control header (CN10). These two control modes are for adjusting the brightness of LVDS panel.

Function	Setting
Controlled by PWM (Default)	1-2 close
Controlled by DC Voltage	2-3 close



2.3.4 AT/ATX Power Mode Select (JP4)

This 3x1-pin p=2.54mm jumper allows you to select AT or ATX power mode.

Function	Setting
ATX mode (Default)	1-2 close
AT mode	2-3 close



2.3.5 COM1 RS-232/422/485 Mode Select (JP5, JP6, JP7)

Use these jumpers (3x2-pin p=2.54mm) to set COM1 port to operate as RS-232, RS-422 or RS-485 communication mode.

Function	Setting
RS-232 mode (Default)	JP5 1-2 close JP6 3-5, 4-6 close JP7 3-5, 4-6 close
RS-422 mode	JP5 3-4 close JP6 1-3, 2-4 close JP7 1-3, 2-4 close
RS-485 mode	JP5 5-6 close JP6 1-3, 2-4 close

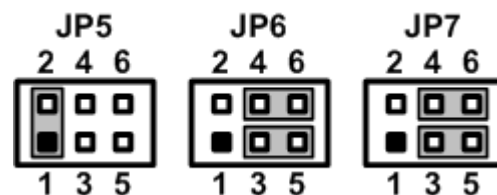

2.3.6 COM2 RS-232/422/485 Mode Select (JP8, JP9, JP10)

Use these jumpers (3x2-pin p=2.54mm) to set COM2 port to operate as RS-232, RS-422 or RS-485 communication mode.

Function	Setting
RS-232 mode (Default)	JP8 1-2 close JP9 3-5, 4-6 close JP10 3-5, 4-6 close
RS-422 mode	JP8 3-4 close JP9 1-3, 2-4 close JP10 1-3, 2-4 close
RS-485 mode	JP8 5-6 close JP9 1-3, 2-4 close

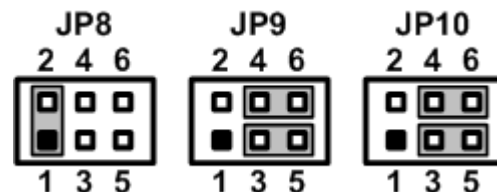

2.3.7 COM3 Data/Power Select (JP11)

The COM3 port has +5V/+12V power capability on DCD and +5V/+12V on RI by setting this 5x2-pin p=2.54mm jumper.

Function	Setting
Power: Set COM3 pin 1 to +12V level	1-3 close
Power: Set COM3 pin 1 to +5V level	3-5 close
Data: Set COM3 pin 1 to DCD# (Default)	7-9 close
Power: Set COM3 pin 8 to +12V level	2-4 close
Power: Set COM3 pin 8 to +5V level	4-6 close
Data: Set COM3 pin 8 to RI# (Default)	9-10 close

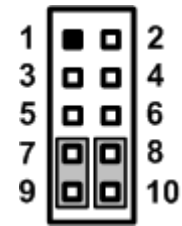

2.4 Connectors

Signals go to other parts of the system through connectors. Loose or improper connection might cause problems, please make sure all connectors are properly and firmly connected. Here is a summary table showing connectors on the hardware.

Connector	Description
CN3	Internal USB 2.0 Header
CN4	SATA 2.0 Connector
CN5	SIM Card Slot
CN8	VGA Connector
CN9	LVDS Signal Header
CN10	LVDS Backlight Control Header
CN11	DC12V Power Input Connector 2
CN12	DC12V Power Input Connector 1
CN13	Power Status Header
CN14	Front Panel Header
CN15	DC12V/5V Power Output Connector
CN16	PS/2 Keyboard and Mouse Connector
CN17	GPIO Header
CN18	COM1~COM2 Connector
CN19~CN22	COM3~COM6 Headers
CN23	DDR3L SO-DIMM Socket
CN24	LAN and USB 2.0 Connector
CN25	LAN, USB 3.0 and USB 2.0 Connector
CN26	PCI-Express x1 Slot
CN27	PCI-Express Mini Card Connector
CN28	mSATA Slot
CN29	HDMI Connector
CN30	Audio Connector
CN31	Front Audio Header
CN32	ATX Power Input Connector
CN33	Fan1 Connector
CN34	Fan2 Connector

2.4.1 Internal USB Header (CN3)

This is USB 2.0 header (5x2-pin p=2.54mm).

Pin	Signal	Pin	Signal
1	+5V	2	+5V
3	USB1-	4	USB2-
5	USB1+	6	USB2+
7	GND	8	GND
9	N/C	10	N/C

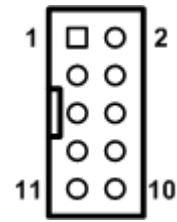

2.4.2 SATA Connectors (CN4)

This connector supports SATA 2.0.

Pin	Signal
1	GND
2	SATA_TXP2
3	SATA_TXN2
4	GND
5	SATA_RXN2
6	SATA_RXP2
7	GND

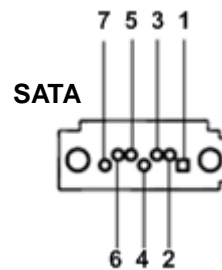

2.4.3 SIM Card Slot (CN5)

The CN5 is for inserting SIM Card. It is mainly used in 3G wireless network application. In order to work properly, the SIM Card must be used together with 3G module which is inserted to CN27.

Pin	Signal
1	PWR
2	RST
3	CLK
4	NC
5	GND
6	VPP
7	I/O
8	NC



2.4.4 VGA Connector (CN8)

The CN8 is a high rise 15-pin D-Sub connector which is commonly used for VGA monitor. This VGA interface configuration can be configured via software utility.

Pin	Signal	Pin	Signal
1	Red	2	Green
3	Blue	4	N.C.
5	GND	6	DETECT
7	GND	8	GND
9	VCC	10	GND
11	N.C.	12	DDC DATA
13	Horizontal Sync	14	Vertical Sync
15	DDC CLK		

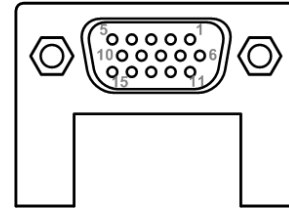

2.4.5 LVDS Signal Header (CN9)

This motherboard has a 20x2-pin p=1.00mm header for LVDS panel interface.

Pin	Signal	Pin	Signal
1	VDD ^[*]	2	VDD ^[*]
3	VDD ^[*]	4	VDD ^[*]
5	VDD ^[*]	6	VDD ^[*]
7	N/C	8	N/C
9	GND	10	GND
11	LVDS_B_DATA3-	12	LVDS_B_DATA0-
13	LVDS_B_DATA3+	14	LVDS_B_DATA0+
15	GND	16	GND
17	LVDS_B_CLK-	18	LVDS_B_DATA1-
19	LVDS_B_CLK +	20	LVDS_B_DATA1+
21	GND	22	GND
23	LVDS_A_DATA0-	24	LVDS_B_DATA2-
25	LVDS_A_DATA0+	26	LVDS_B_DATA2+
27	GND	28	GND
29	LVDS_A_DATA1-	30	LVDS_A_DATA3-
31	LVDS_A_DATA1+	32	LVDS_A_DATA3+
33	GND(Detect) ^[**]	34	GND
35	LVDS_A_DATA2-	36	LVDS_A_CLK-
37	LVDS_A_DATA2+	38	LVDS_A_CLK +
39	GND	40	GND



Note

^[*]: Panel power VDD is +3.3V by default. This VDD signal is selectable by jumper JP2, see section 2.3.2.

^[**]: Grounding of this pin is required to ensure normal LVDS output.

^[***]: Connector type: GeanLea GLA1001WV-S-2X20 for reference.

2.4.6 LVDS Backlight Control Header (CN10)

This is an 8x1-pin p=1.25mm header for LVDS backlight control interface.

Pin	Signal
1	+12V
2	+12V
3	+5V
4	LVDS_BKL_EN
5	GND
6	GND
7	GND
8	LVDS_BKL_CTL ^[1]

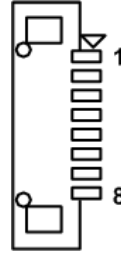

Note

^[1]: This signal is selectable by jumper JP3, see section 2.3.3.

^[**]: Connector type: GeanLea GLA1252WV-S-F-8P for reference.

2.4.7 DC12V Power Input Connector 1 (CN12)

This is a 4-pin connector for DC +12V power input.

Pin	Signal
1	GND
2	GND
3	+ 12V IN
4	+ 12V IN

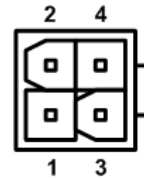

2.4.8 Power Status Header (CN13)

This is power status header (2x1-pin p=2.54mm), let customer know the power status of board.

Pin	Signal
1	PWR+
2	PWR-



2.4.9 Front Panel Header (CN14)

This is front panel header (7x2-pin p=2.54mm).

Pin	Signal
1	Power LED+
2	SPK- ^[1]
3	GND
4	BUZZER
5	Power LED-
6	N/C
7	N/C
8	SPK+ ^[1]
9	PWR-
10	PWR+
11	RESET-
12	RESET+
13	HD LED-
14	HD LED+

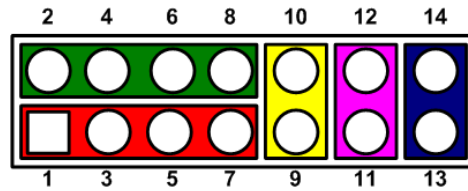

Note

^[1]: The motherboard's own buzzer will be active when pin 2 and pin 4 is connecting, the external speaker on chassis will be active when pin 2 and pin 4 is open.

2.4.10 DC12V/5V Power Output Connector (CN15)

This is a 4x1-pin p=2.54mm connector for DC +12V and +5V power output.

Pin	Signal
1	+12V
2	GND
3	GND
4	+5V

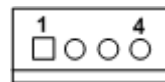

2.4.11 PS/2 Keyboard and Mouse Connector (CN16)

The board has two 6-pin mini-DIN PS/2 connectors; green for mouse and purple for keyboard.

Pin	Signal	Pin	Signal
1	K/B Data	7	M/S Data
2	NC	8	NC
3	GND	9	GND
4	+5V	10	+5V
5	K/B CLK	11	M/S CLK
6	NC	12	NC

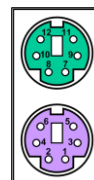

2.4.12 GPIO Header (CN17)

This header (5x2-pin p=2.54mm) is for digital I/O interface.

Pin	Signal	Pin	Signal
1	SIO_GPO74 (0xA06, Bit4, H) ^[1]	2	SIO_GPI70 (0xA06, Bit0)
3	SIO_GPO75 (0xA06, Bit5, H) ^[1]	4	SIO_GPI71 (0xA06, Bit1)
5	SIO_GPO76 (0xA06, Bit6, H) ^[1]	6	SIO_GPI72 (0xA06, Bit2)
7	SIO_GPO77 (0xA06, Bit7, H) ^[1]	8	SIO_GPI73 (0xA06, Bit3)
9	GND	10	GND

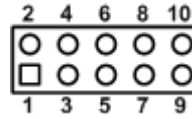

Note

^[1]: “H” or “L” means the default voltage is High or Low level, and GPIO output is 5V.

2.4.13 COM Connector (CN18)

This connector is for COM1 and COM2 serial port interfaces which are selectable for RS-232/422/485 mode. If you need COM1 to support RS-422 or RS-485, please refer to section 2.3.5. If you need COM2 to support RS-422 or RS-485, please refer to section 2.3.6. The pin assignments of RS-232/422/485 are listed in table below.

Pin	RS-232	RS-422	RS-485
1	DCD#	TX-	485-
2	RXD	TX+	485+
3	TXD	RX+	N/C
4	DTR#	RX-	N/C
5	GND	GND	GND
6	DSR#	N/C	N/C
7	RTS#	N/C	N/C
8	CTS#	N/C	N/C
9	RI#	N/C	N/C

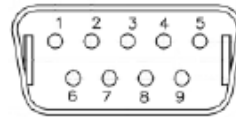

2.4.14 COM Headers (CN19~CN22)

The motherboard comes with 5x2-pin p=2.54mm headers for COM3~COM6 serial port interfaces. Only COM3 comes with power capability on DCD# and RI# pins by setting JP11 (see section 2.3.7).

Pin	Signal	Pin	Signal
1	DCD#	2	DSR#
3	RXD	4	RTS#
5	TXD	6	CTS#
7	DTR#	8	RI#
9	GND	10	N/C

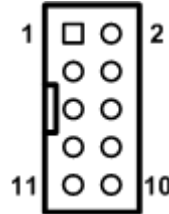

2.4.15 LAN and USB Connectors (CN24 and CN25)

The board comes with two high performance plug and play Ethernet interfaces (RJ-45) which are fully compliant with the IEEE 802.3 standard. Connection can be established by plugging one end of the Ethernet cable into this RJ-45 connector and the other end to a 1000/100/10-Base-T hub.

The CN24 has lower double-deck connector for USB 2.0 port 1 and 2.

Pin	LAN2 Signal	Pin	USB Signal
L1	MDI0+	1	+5V standby power
L2	MDI0-	2	USB D1-
L3	MDI1+	3	USB D1+
L4	MDI1-	4	Ground (GND)
L5	MDI2+	5	+5V standby power
L6	MDI2-	6	USB D2-
L7	MDI3+	7	USB D2+
L8	MDI3-	8	Ground (GND)
A	100 LAN LED (Green)/1000 LAN LED (Orange)		
B	Active LED (Yellow)		

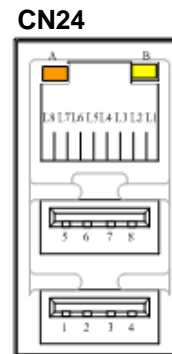

The CN25 has lower double-deck connector for USB 3.0 port 1 and USB 2.0 port 3.

Pin	LAN1 Signal	Pin	LAN1 Signal
L1	MDI0+	L5	MDI2+
L2	MDI0-	L6	MDI2-
L3	MDI1+	L7	MDI3+
L4	MDI1-	L8	MDI3-
A	100 LAN LED (Green)/1000 LAN LED (Orange)		
B	Active LED (Yellow)		

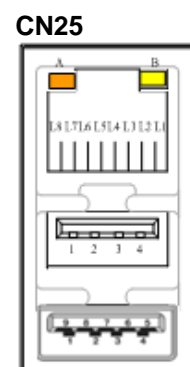

Pin	USB 3.0 Signal	Pin	USB 2.0 Signal
1	USB_VCC (+5V standby power)	1	+5V standby power
2	USB_Data0-	2	USB D1-
3	USB_Data0+	3	USB D1+
4	GND	4	Ground (GND)
5	SSRX1-		
6	SSRX1+		
7	GND		
8	SSTX1-		
9	SSTX1+		

2.4.16 PCI-Express x1 Slot (CN26)

This board has one PCI-Express x1 slot.

Pin	Signal	Pin	Signal
B1	+12V	A1	PRSNT1#
B2	+12V	A2	+12V
B3	RSVD	A3	+12V
B4	GND	A4	GND
B5	SMCLK	A5	NC
B6	SMDAT	A6	NC
B7	GND	A7	NC
B8	+3.3V	A8	NC
B9	NC	A9	+3.3V
B10	3.3Vaux	A10	+3.3V
B11	WAKE#	A11	PERST#
B12	NC	A12	GND
B13	GND	A13	REFCLK+
B14	HSOP0	A14	REFCLK-
B15	HSO0	A15	GND
B16	GND	A16	HSIP0
B17	NC	A17	HSIN0
B18	GND	A18	GND

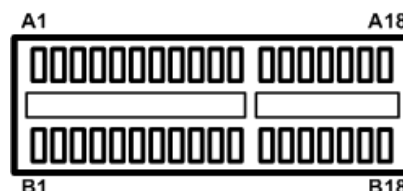

2.4.17 Full-size PCI-Express Mini Card Connector (CN27)

This is a PCI-Express Mini Card connector applying to PCI-Express or USB 2.0. It complies with PCI-Express Mini Card Spec. V1.2.

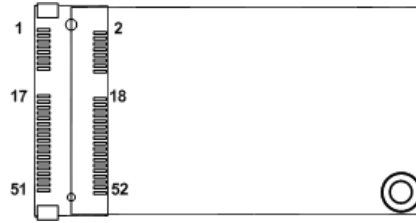

2.4.18 mSATA Slot (CN28)

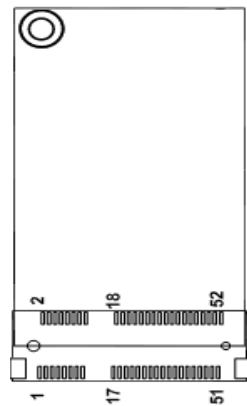

2.4.19 HDMI Connector (CN29)

The HDMI (High-Definition Multimedia Interface) interface is available through this connector.

Pin	Signal	Pin	Signal
1	HDMI OUT_DATA2+	2	GND
3	HDMI OUT_DATA2-	4	HDMI OUT_DATA1+
5	GND	6	HDMI OUT_DATA1-
7	HDMI OUT_DATA0+	8	GND
9	HDMI OUT_DATA0-	10	HDMI OUT_Clock+
11	GND	12	HDMI OUT_Clock-
13	N.C.	14	N.C.
15	HDMI OUT_SCL	16	HDMI OUT_SDA
17	GND	18	+5V
19	HDMI_HTPLG		

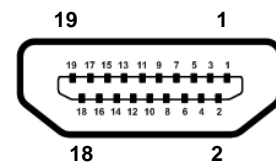

2.4.20 Audio Jack (CN30)

The board provides HD audio jack on the rear I/O. Install audio driver, and then attach audio devices to CN30.

Pin Color	Signal
Green	Line-out
Pink	MIC-in



2.4.21 Front Audio Header (CN31)

This is front audio header (5x2-pin p=2.00mm) for convenient connection and control of audio devices.

Pin	Signal	Pin	Signal
1	FP_MIC_IN	2	GND
3	FP_IN_L	4	GND
5	FP_IN_R	6	GND
7	FP_OUT_L	8	GND
9	FP_OUT_R	10	GND

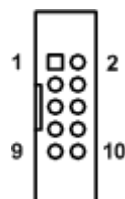

2.4.22 Fan Connectors (CN33 and CN34)

This motherboard has two fan connectors. You can find fan speed option(s) at BIOS Setup Utility. For further information, see BIOS Setup Utility: Advanced\HW Monitor\PC Health Status.

The CN33 (4x1-pin p=2.54mm) is for Fan1 interface.

Pin	Signal
1	GND
2	+12V
3	FAN Speed Detection
4	FAN Speed Control



The CN34 (3x1-pin p=2.54mm) is for Fan2 interface.

Pin	Signal
1	GND
2	+12V
3	FAN Speed Detection

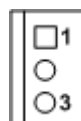

Chapter 3

Hardware Description

3.1 Microprocessors

The MANO842 Series supports Intel® Celeron® J1900 processor, which enable your system to operate under Windows® 7, Windows® 8, Windows® 8.1 and Linux environments. The system performance depends on the microprocessor. Make sure all correct settings are arranged for your installed microprocessor to prevent the CPU from damages.

3.2 BIOS

The MANO842 Series uses AMI Plug and Play BIOS with a single SPI Flash.

3.3 System Memory

The MANO842 supports one 204-pin DDR3L SO-DIMM socket for maximum memory capacity up to 8GB DDR3L SDRAMs. The memory module comes in sizes of 1GB, 2GB, 4GB and 8GB.

This page is intentionally left blank.

Chapter 4

AMI BIOS Setup Utility

The AMI UEFI BIOS provides users with a built-in setup program to modify basic system configuration. All configured parameters are stored in a flash chip to save the setup information whenever the power is turned off. This chapter provides users with detailed description about how to set up basic system configuration through the AMI BIOS setup utility.

4.1 Starting

To enter the setup screens, follow the steps below:

1. Turn on the computer and press during the Power On Self Test (POST) to enter BIOS setup, otherwise, POST will continue with its test routines.
2. Once you enter the BIOS, the main BIOS setup menu displays. You can access the other setup screens from the main BIOS setup menu, such as the Advanced and Chipset menus.



Note

If your computer cannot boot after making and saving system changes with BIOS setup, you can restore BIOS optimal defaults by setting JP1 (see section 2.3.1).

It is strongly recommended that you should avoid changing the chipset's defaults. Both AMI and your system manufacturer have carefully set up these defaults that provide the best performance and reliability.

4.2 Navigation Keys

The BIOS setup/utility uses a key-based navigation system called hot keys. Most of the BIOS setup utility hot keys can be used at any time during the setup navigation process. These keys include <F1>, <F2>, <Enter>, <ESC>, <Arrow> keys, and so on.



Note

Some of the navigation keys differ from one screen to another.

Hot Keys	Description
→← Left/Right	The Left and Right <Arrow> keys allow you to select a setup screen.
↑↓ Up/Down	The Up and Down <Arrow> keys allow you to select a setup screen or sub screen.
Enter	The <Enter> key allows you to display or change the setup option listed for a particular setup item. The <Enter> key can also allow you to display the setup sub screens.
+– Plus/Minus	The Plus and Minus <Arrow> keys allow you to change the field value of a particular setup item.
F1	The <F1> key allows you to display the General Help screen.
F2	The <F2> key allows you to Load Previous Values.
F3	The <F3> key allows you to Load Optimized Defaults.
F4	The <F4> key allows you to save any changes you have made and exit Setup. Press the <F4> key to save your changes.
Esc	The <Esc> key allows you to discard any changes you have made and exit the Setup. Press the <Esc> key to exit the setup without saving your changes.

4.3 Main Menu

When you first enter the setup utility, you will enter the Main setup screen. You can always return to the Main setup screen by selecting the Main tab. System Time/Date can be set up as described below. The Main BIOS setup screen is shown below.

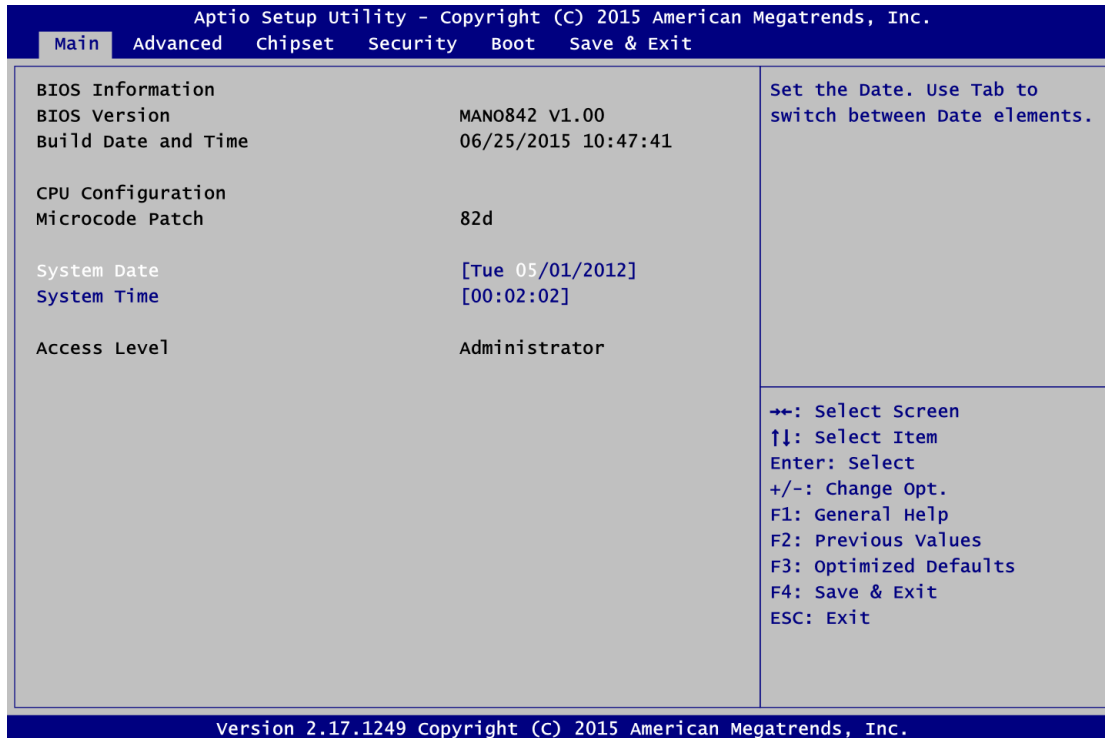

BIOS Information

Display the BIOS information.

System Date/Time

Use this option to change the system time and date. Highlight System Time or System Date using the <Arrow> keys. Enter new values through the keyboard. Press the <Tab> key or the <Arrow> keys to move between fields. The date must be entered in MM/DD/YY format. The time is entered in HH:MM:SS format.

Access Level

Display the access level of current user.

4.4 Advanced Menu

The Advanced menu also allows users to set configuration of the CPU and other system devices. You can select any of the items in the left frame of the screen to go to the sub menus:

- ▶ ACPI Settings
- ▶ Super IO Configuration
- ▶ Hardware Monitor
- ▶ Smart Fan Function
- ▶ Display Configuration
- ▶ Power Button Control
- ▶ S5 RTC Wake Settings
- ▶ CPU Configuration
- ▶ IDE Configuration
- ▶ OS Configuration
- ▶ CSM Configuration
- ▶ USB Configuration

For items marked with “▶”, please press <Enter> for more options.

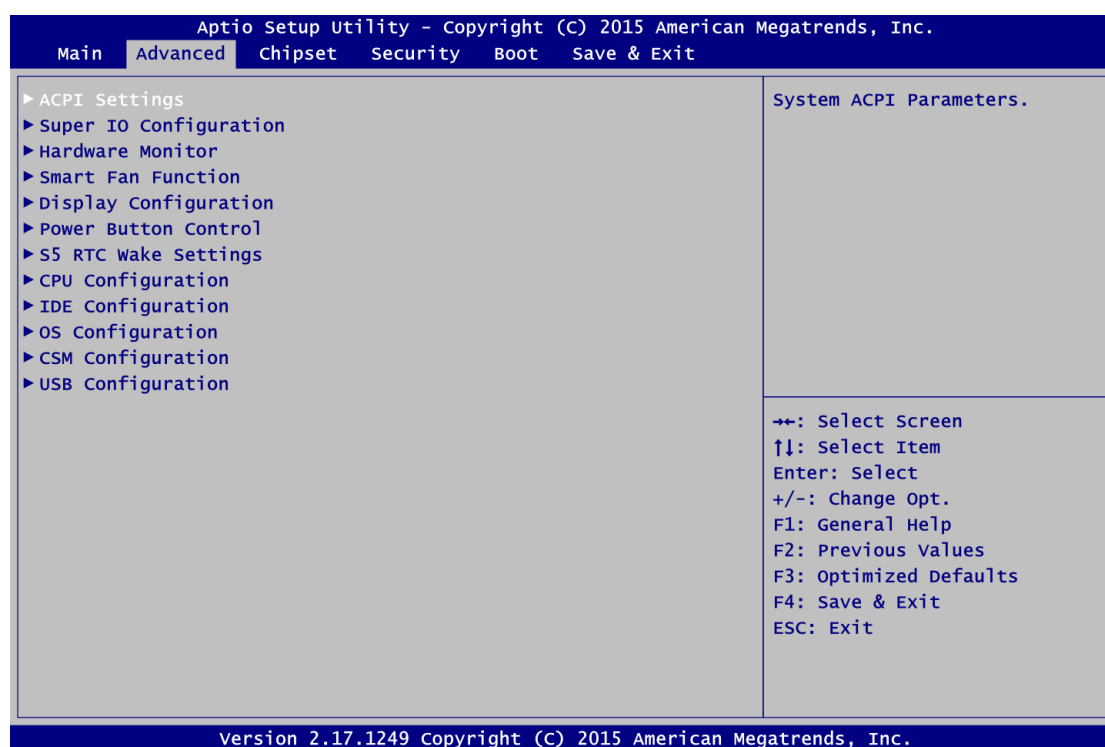

- **ACPI Settings**

You can use this screen to select options for the ACPI configuration, and change the value of the selected option. A description of the selected item appears on the right side of the screen.

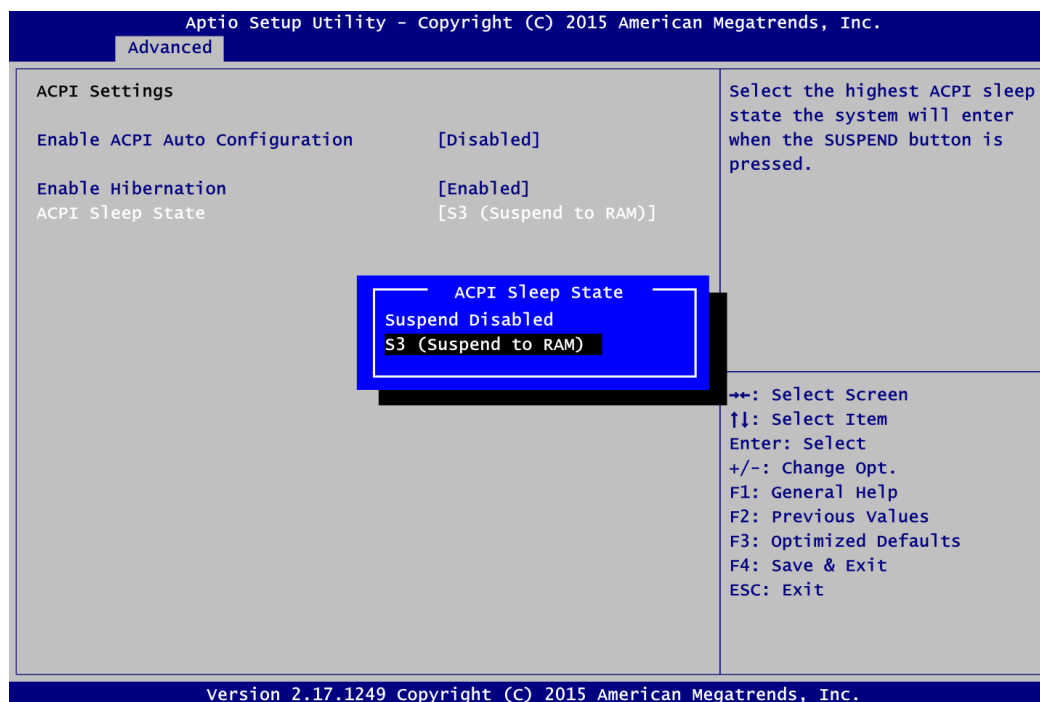

Enable ACPI Auto Configuration

Enable or disable BIOS ACPI auto configuration.

Enable Hibernation

Enable or disable system ability to hibernate (OS/S4 sleep state).

ACPI Sleep State

Select the ACPI (Advanced Configuration and Power Interface) sleep state. Configuration options are Suspend Disabled and S3 (Suspend to RAM). The default setting is S3 (Suspend to RAM); this option selects ACPI sleep state the system will enter when suspend button is pressed.

- **Super IO Configuration**

You can use this screen to select options for the Super IO Configuration, and change the value of the selected option. A description of the selected item appears on the right side of the screen. For items marked with "▶", please press <Enter> for more options.

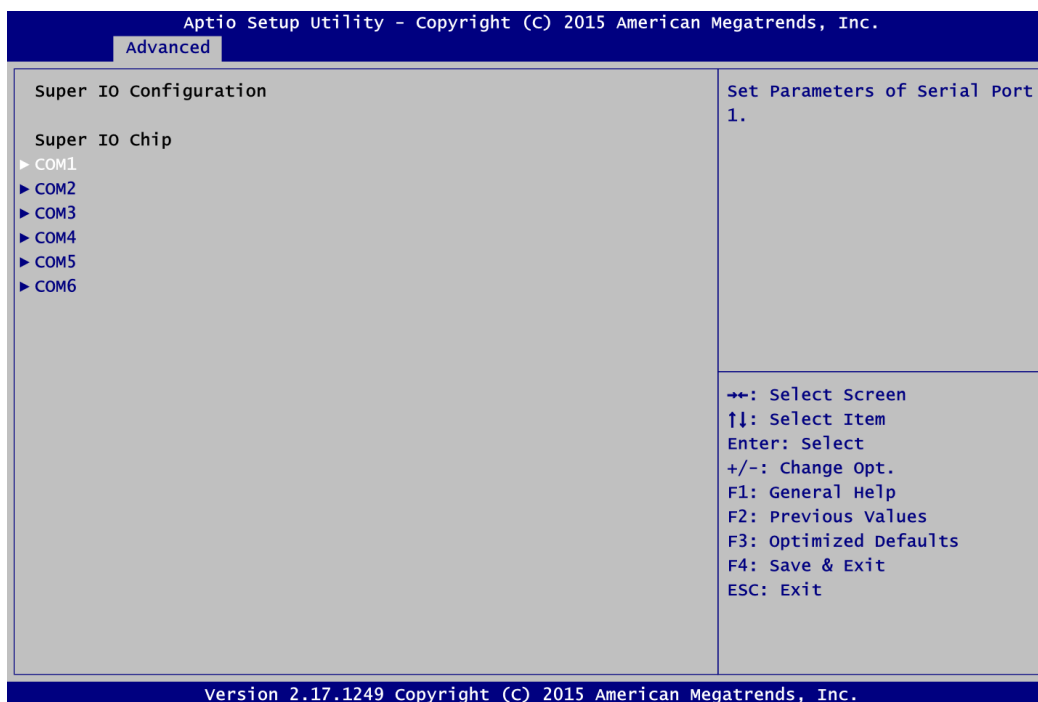

COM1~6

Use these items to set parameters related to serial port 1~6.

- **COM1**

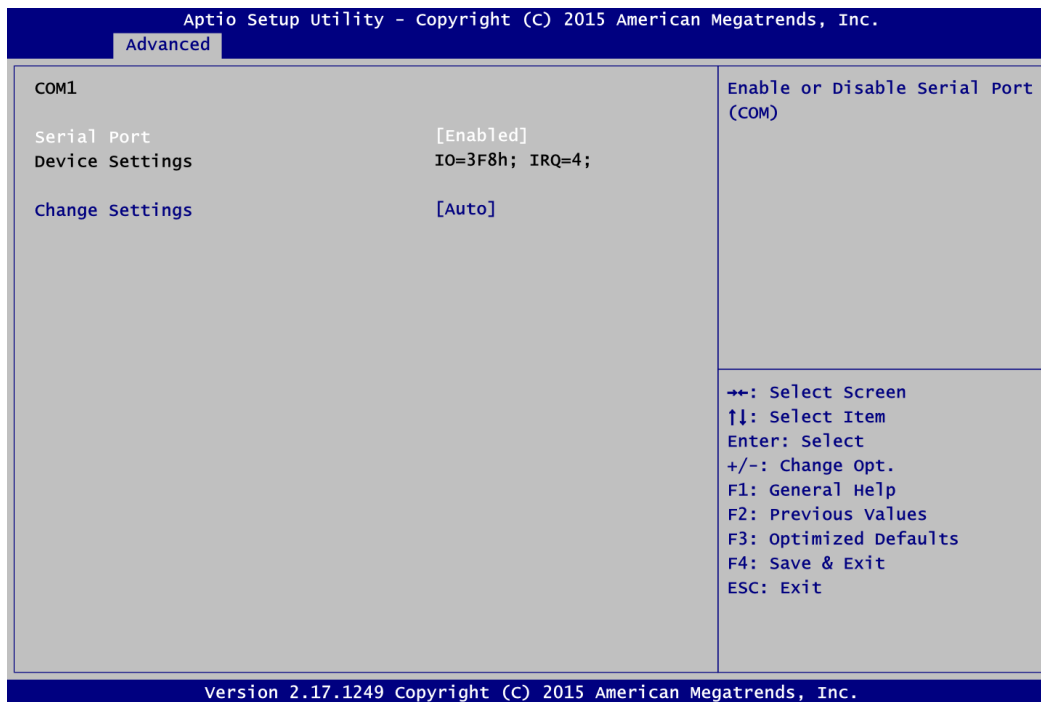
**Serial Port**

Enable or disable serial port 1. The optimal setting for base I/O address is 3F8h and for interrupt request address is IRQ4.

Change Settings

Select an optimal setting for serial port.

- **Hardware Monitor**

This screen monitors hardware health status.

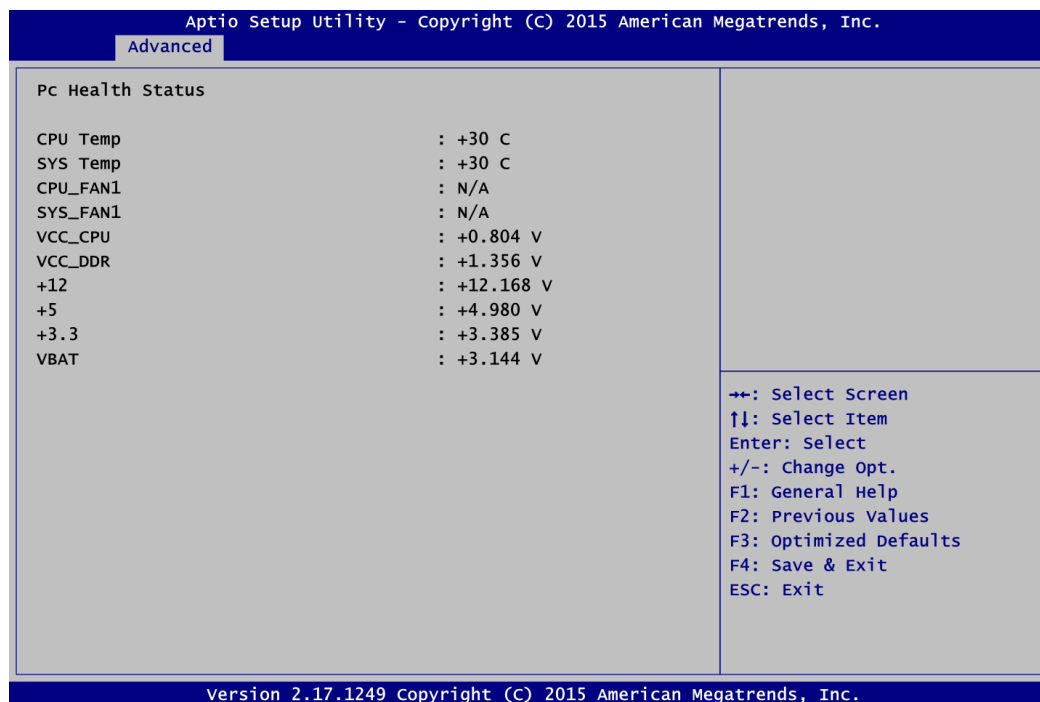

This screen displays the temperature of system and CPU, cooling fans speed in RPM and system voltages (VCC_CPU, VCC_DDR, +12V, +5V, +3.3V and VBAT).

- **Smart Fan Function**

This screen allows you to select the fan mode.

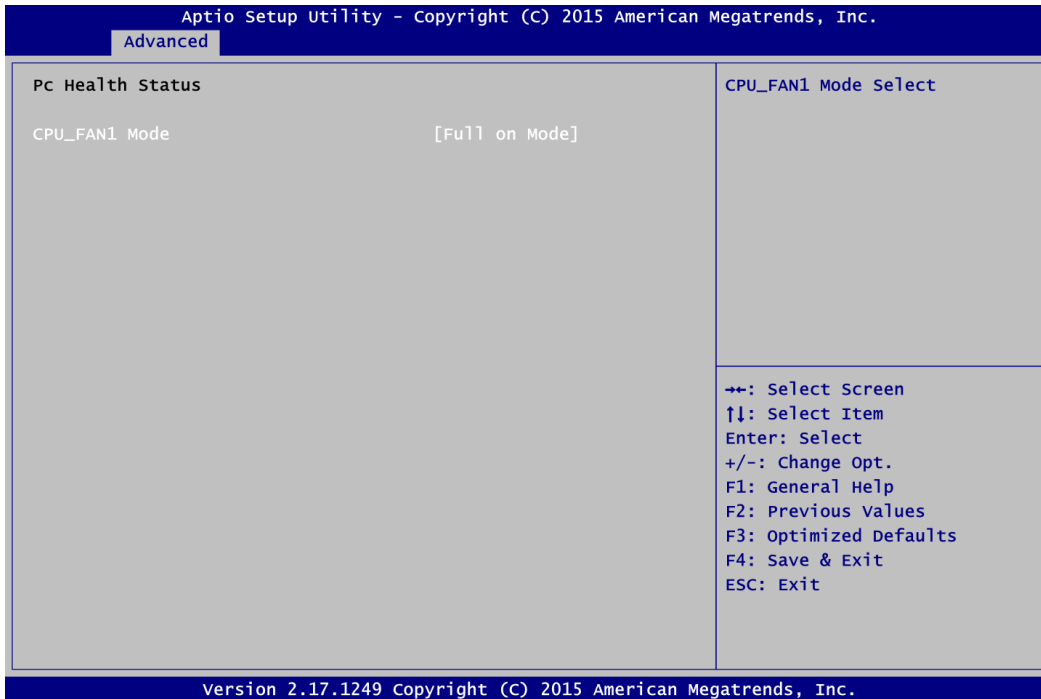

CPU_FAN1 Mode

This item allows you to select the fan mode, which can be set to Full on Mode, Manual Mode, Auto PWM Mode or Auto RPM Mode.

● **Display Configuration**

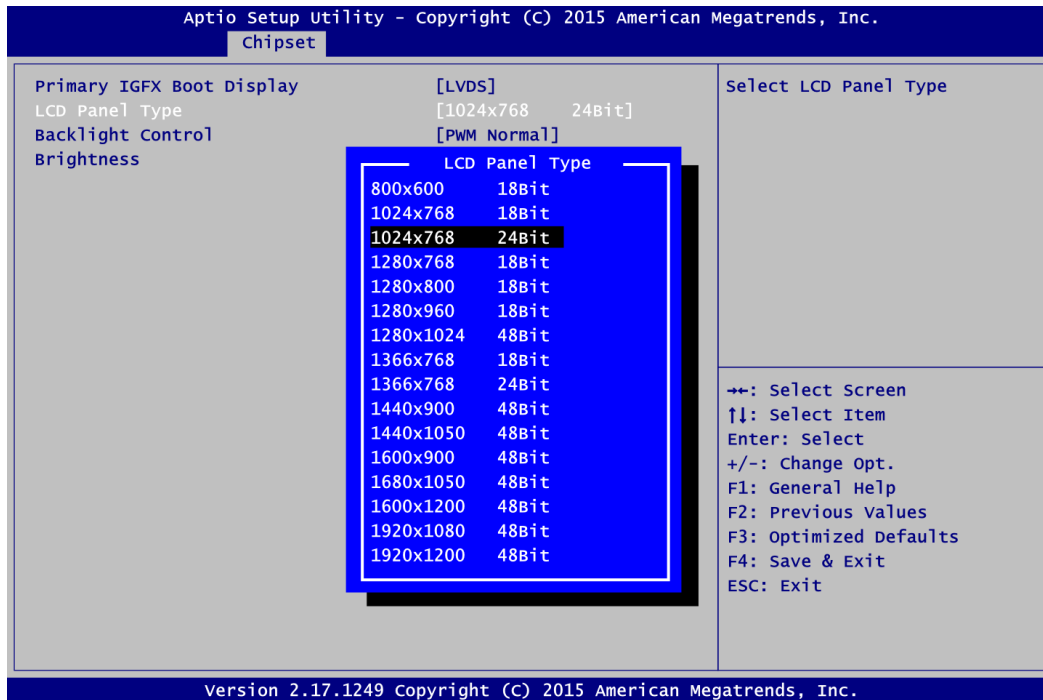

Primary IGFX Boot Display

Select the video device which will be activated during POST (Power-On Self Test). The default is LVDS.

Backlight Control

Select panel backlight control mode.

LVDS Panel Type

Select LVDS panel resolution; see the selection options in image above.

Brightness

Select the brightness of LVDS panel ranging from 30% to 100%. The default setting is 70%.

- **Power Button Control**

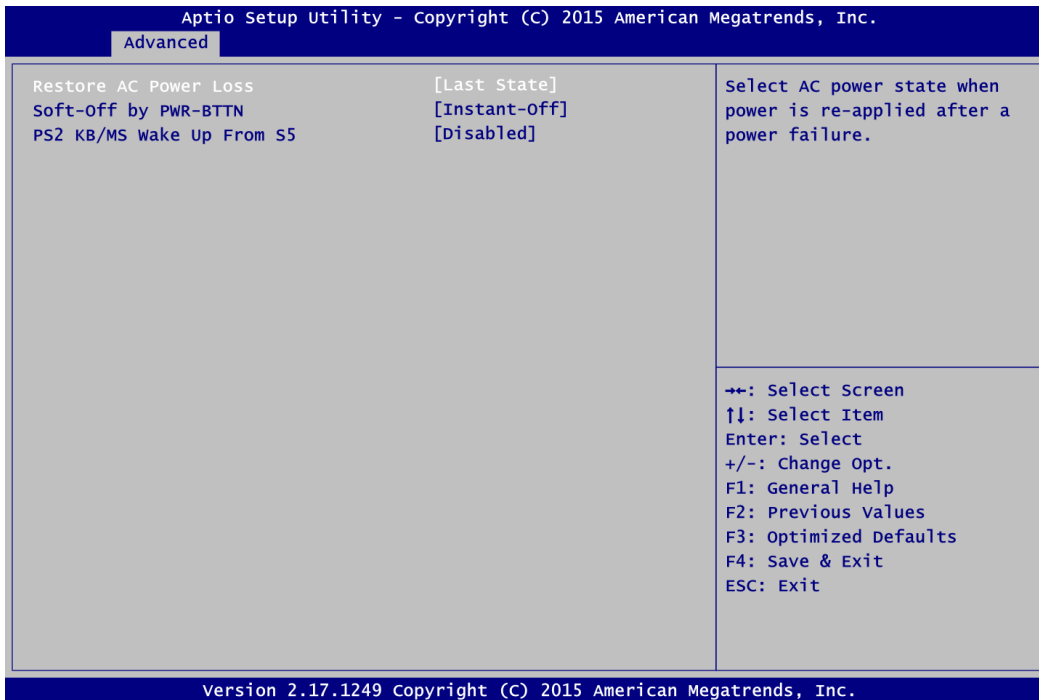

Restore AC Power Loss

This item decides the state of system when AC power is resupplied after a power failure. Mode options are Power Off, Power On and Last State.

Soft-Off by PWR-BTTN

- Instant-Off: The system will shut down instantly when the power button is pressed.
- Delay 4 sec: The system will shut down only when the power button is pressed and held at least 4 seconds.

PS/2 KB/MS Wake Up From S5

This item decides whether or not the PS/2 keyboard or mouse can wake up the system from S5 state.

- **S5 RTC Wake Settings**

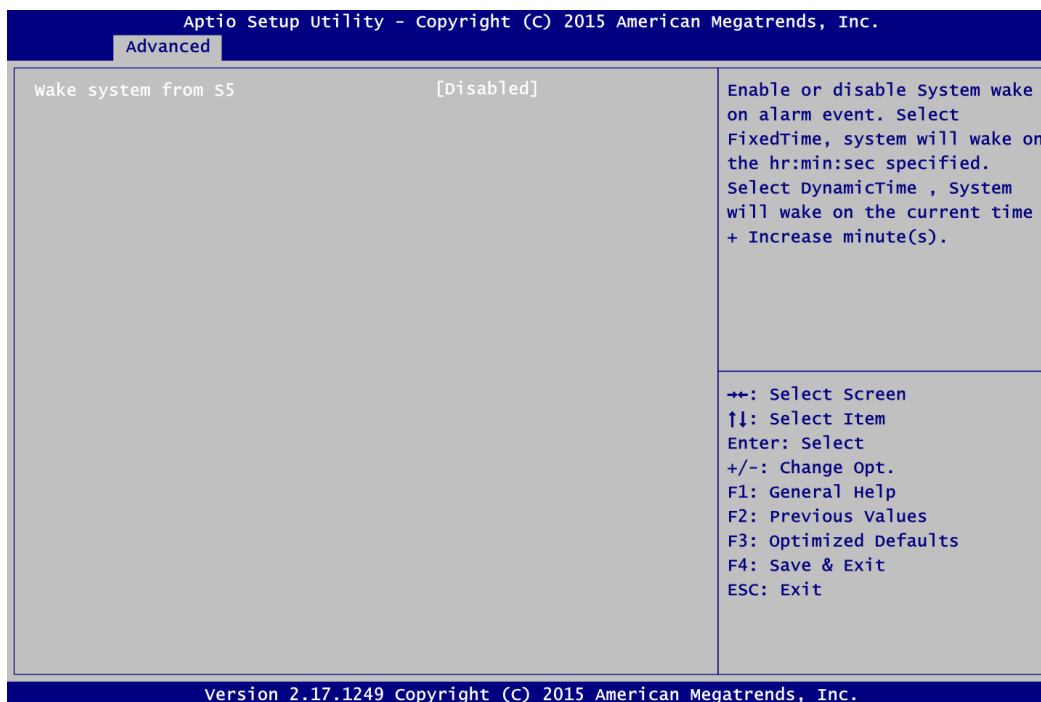

Wake system from S5

Enable or disable system wake on alarm event. It allows you to wake up the system in a certain time. Select Fixed Time to set the system to wake on the specified time. Use <↑> <↓> to switch among the items: Day, Hour, Minute and Second, and type the value in the selected item as you wish. For example, if you want the system to start up automatically at 14:25:26, the 13th day of each month, then you should enter 13, 14, 25, and 26 from top to bottom.

- **CPU Configuration**

This screen shows the CPU Configuration, and you can change the value of the selected option.

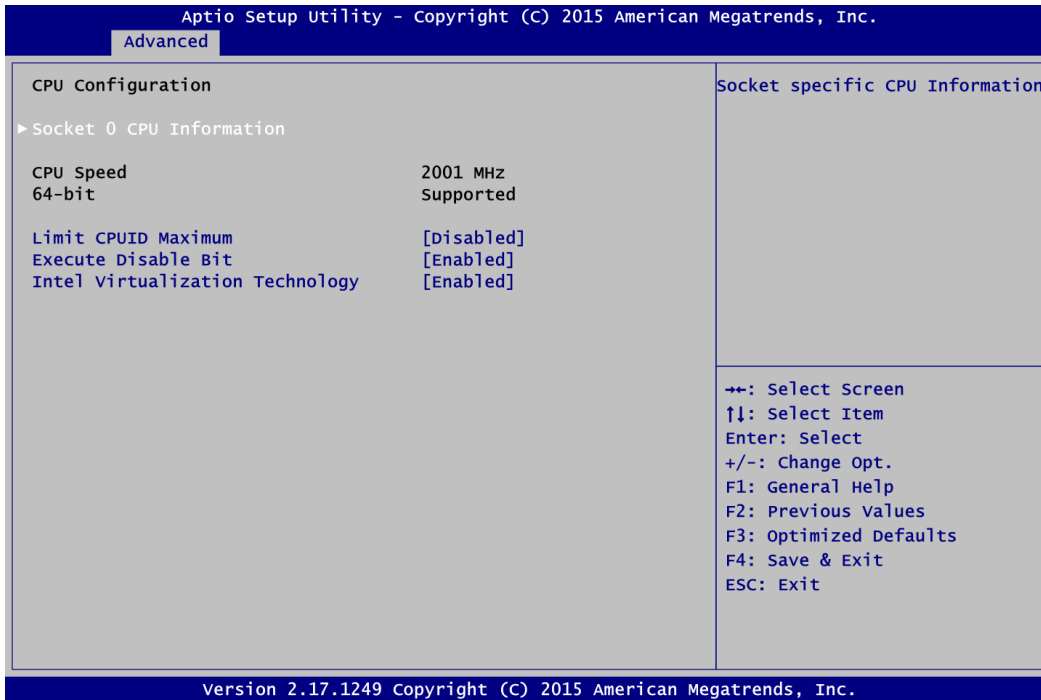

Socket 0 CPU Information

This item is for CPU information.

Limit CPUID Maximum

This item allows user to limit the maximum value of CPUID. In Windows XP environment, this item should be disabled.

Execute Disable Bit

Enable or disable the No-Execution Page Protection Technology.

Intel Virtualization Technology

Enable or disable Intel Virtualization Technology. When enabled, a VMM (Virtual Machine Mode) can utilize the additional hardware capabilities. It allows a platform to run multiple operating systems and applications independently, hence enabling a computer system to work as several virtual systems.

- **IDE Configuration**

In the IDE Configuration menu, you can see the currently installed hardware in the SATA ports. During system boot up, the BIOS automatically detects the presence of SATA devices.

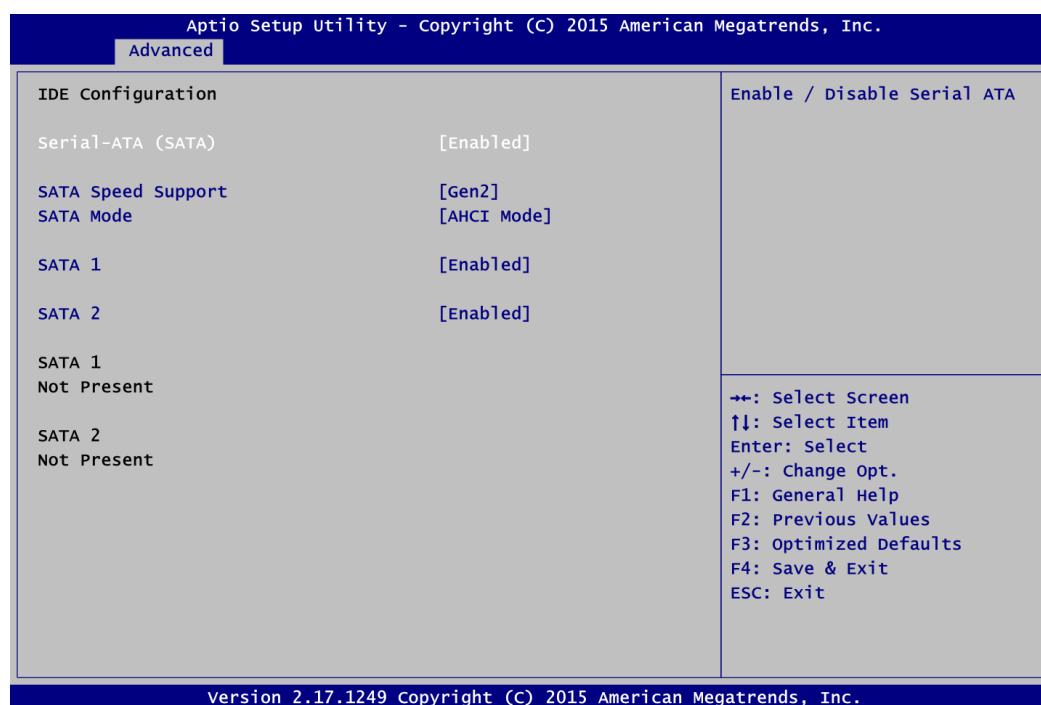

Serial-ATA (SATA)

Enable or disable the SATA controller feature.

SATA Speed Support

Select SATA speed support.

SATA Mode

Determine how SATA controller(s) operate. Operation mode options are IDE Mode, AHCI (Advanced Host Controller Interface) Mode. The default is AHCI Mode.

SATA 1~2

Enable or disable the onboard SATA port 1~2.

- **OS Configuration**

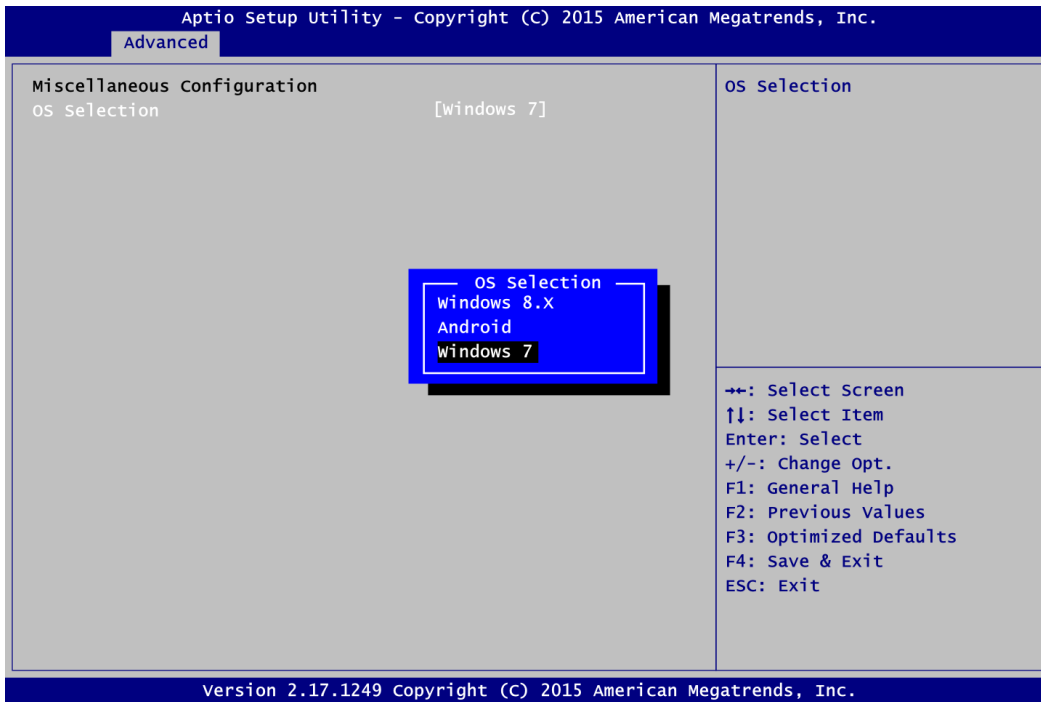

OS Selection

This item allows user to select the proper Operating System.

● **CSM Configuration**

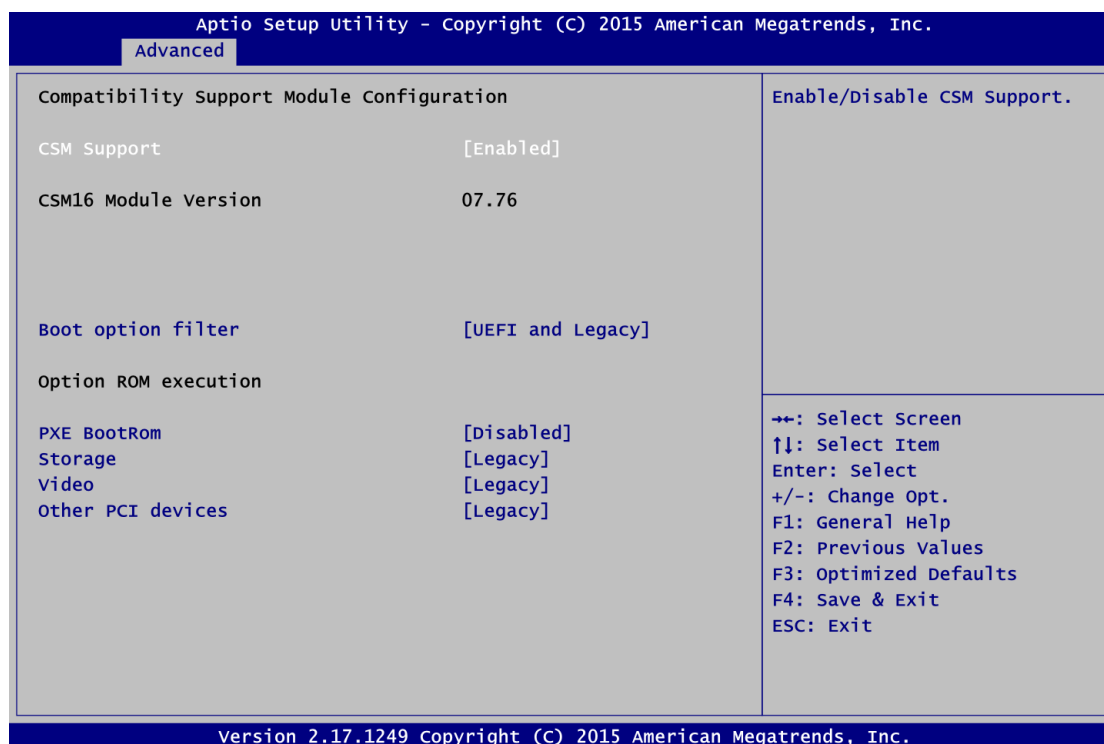

CSM Support

Enable or disable CSM (Compatibility Support Module) support.

Boot option filter

Select UEFI or Legacy ROM priority. Default is UEFI and Legacy mode.

PXE BootRom

Enable or disable the Preboot eXecution Environment (PXE) boot ROM function of the onboard LAN chip during system boots up.

Storage

Select the execution of UEFI or Legacy storage option ROM. Default is Legacy mode.

Video

Select the execution of UEFI or Legacy video option ROM. Default is Legacy mode.

Other PCI devices

Select the execution of UEFI or Legacy option ROM of other PCI-Express network, storage or video devices. Default is Legacy mode.

- **USB Configuration**

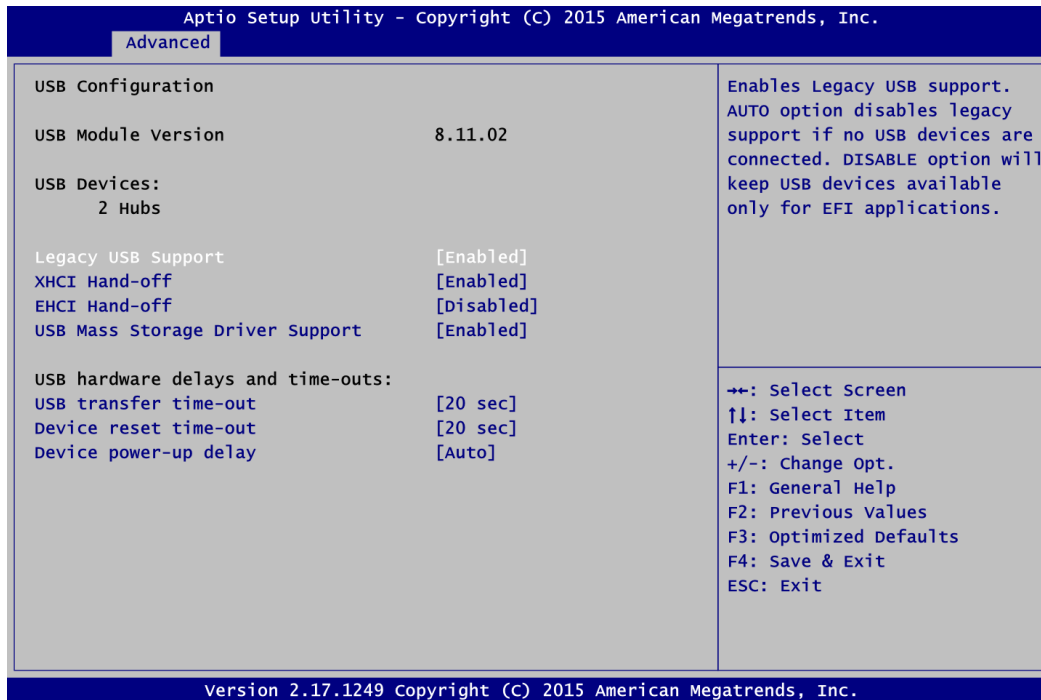

USB Devices

Display all detected USB devices.

Legacy USB Support

Use this item to enable or disable legacy support for USB devices. The default setting is Enabled. Auto option disables legacy support if no USB devices are connected. Disable option will keep USB devices available only for EFI applications.

XHCI Hand-off

Enable or disable feature for OSes without an XHCI hand-off support.

EHCI Hand-off

Enable or disable feature for OSes without an EHCI hand-off support.

USB Mass Storage Driver Support

Enable or disable USB mass storage driver support.

USB transfer time-out

The time-out value for control, bulk and interrupt transfers.

Device reset time-out

USB mass storage device start unit command time-out.

Device power-up delay

Maximum time the device will take before it properly reports itself to the host controller. Auto option uses default value: for a root port it is 100ms, for a hub port the delay is taken from hub descriptor.

4.5 Chipset Menu

The Chipset menu allows users to change the advanced chipset settings. You can select any of the items in the left frame of the screen to go to the sub menus:

- ▶ North Bridge
- ▶ South Bridge

For items marked with “▶”, please press <Enter> for more options.

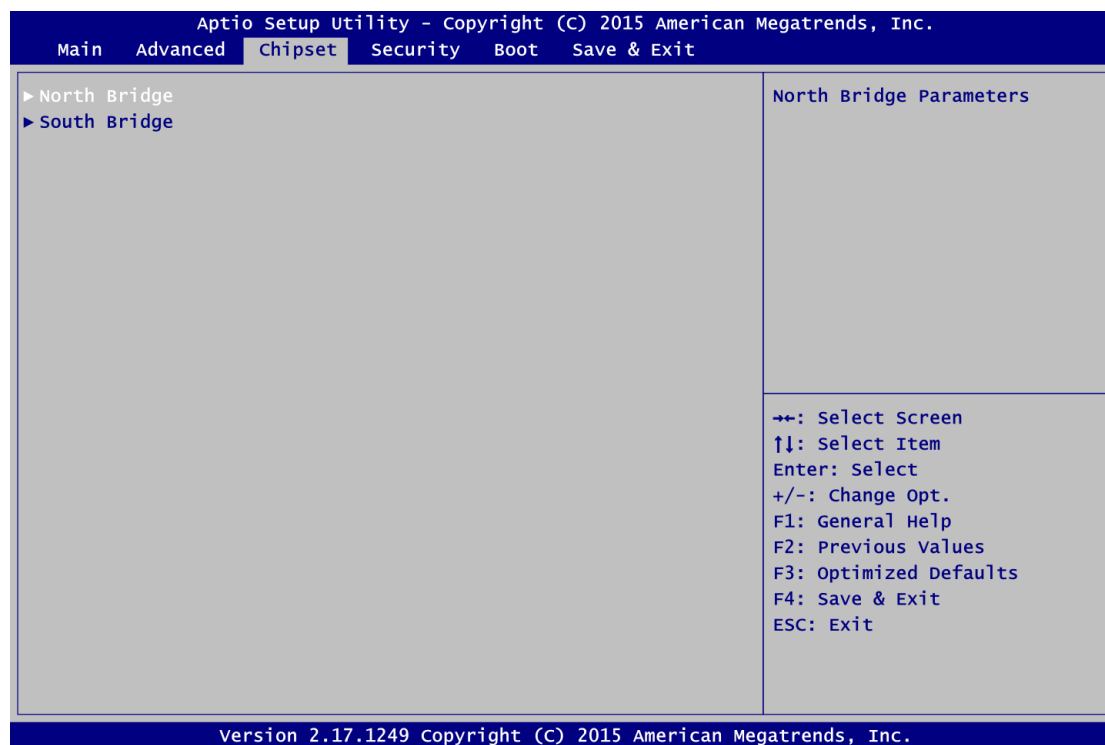

- **North Bridge**

This screen shows system memory information.

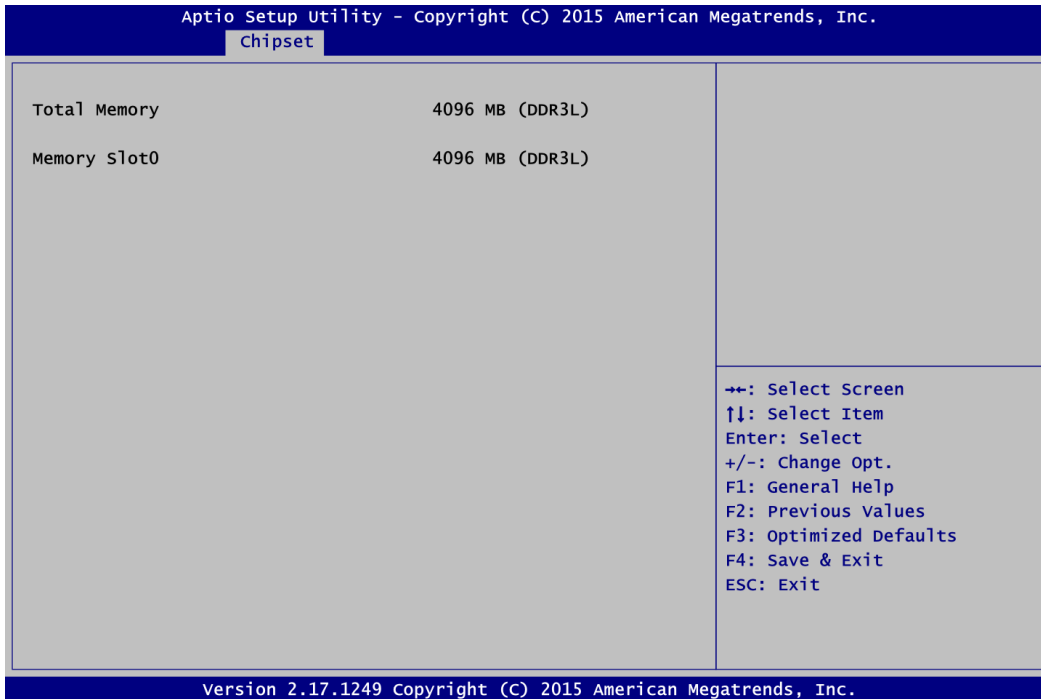

- **South Bridge**

This screen allows users to configure parameters of South Bridge chipset.

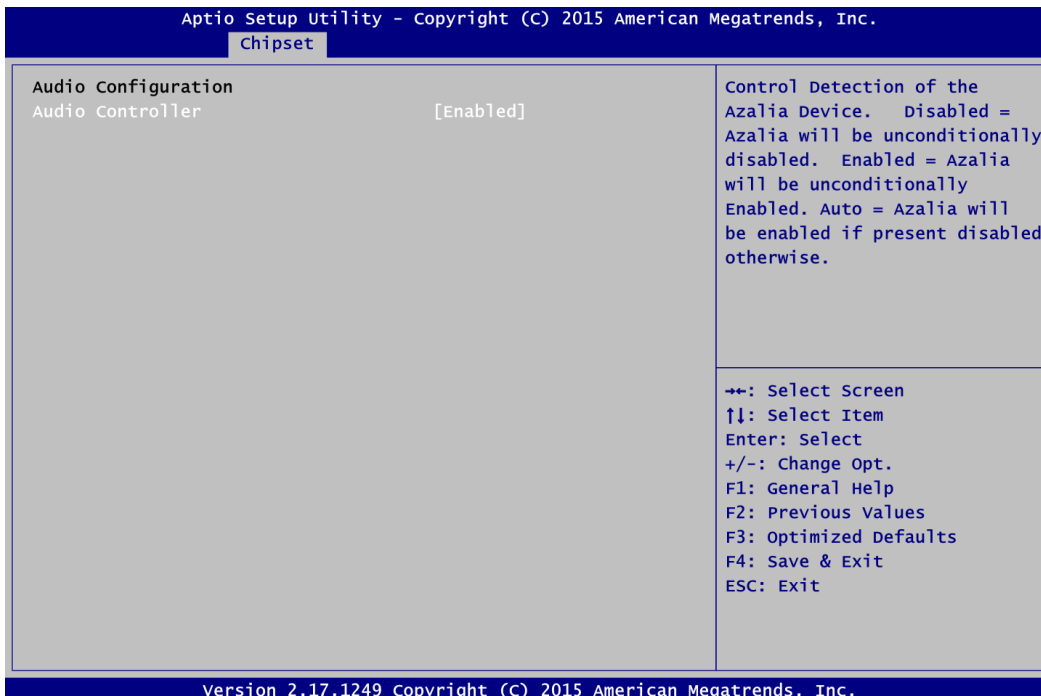

Audio Controller

Control detection of the audio device.

- Disabled: Audio device will be unconditionally disabled.
- Enabled: Audio device will be unconditionally enabled.
- Auto: If device is present, audio controller will be enabled, otherwise will be disabled.

4.6 Security Menu

The Security menu allows users to change the security settings for the system.

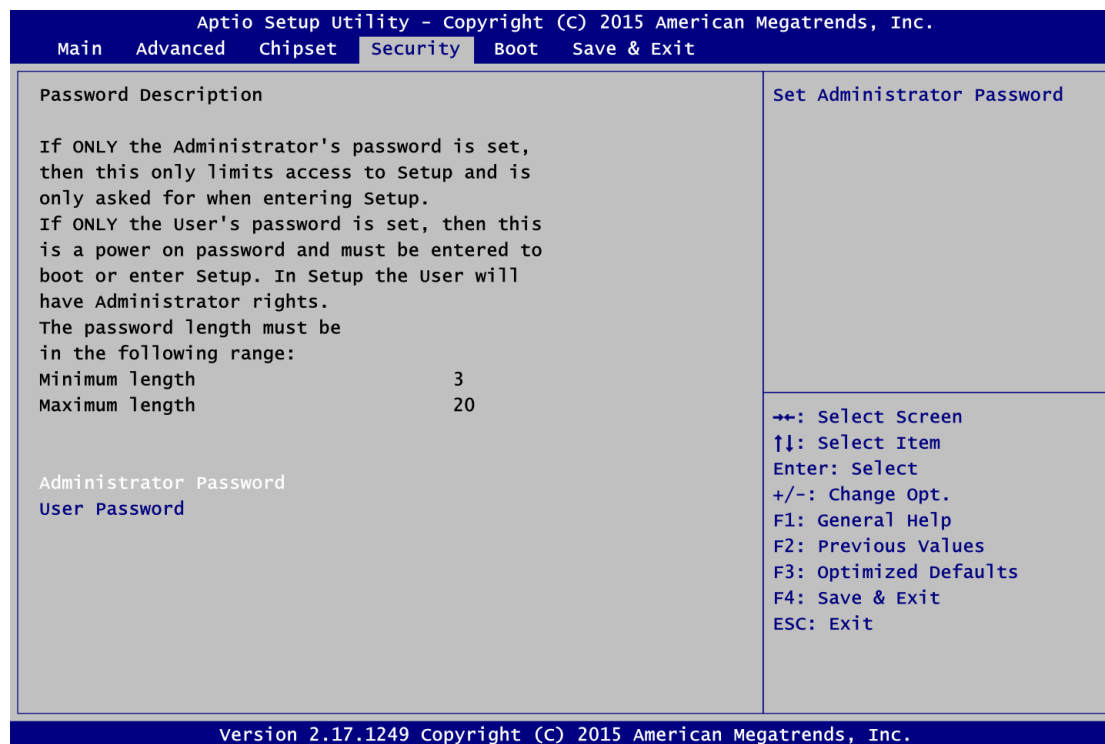

- **Administrator Password**
This item indicates whether an administrator password has been set (installed or uninstalled).
- **User Password**
This item indicates whether a user password has been set (installed or uninstalled).

4.7 Boot Menu

The Boot menu allows users to change boot options of the system.

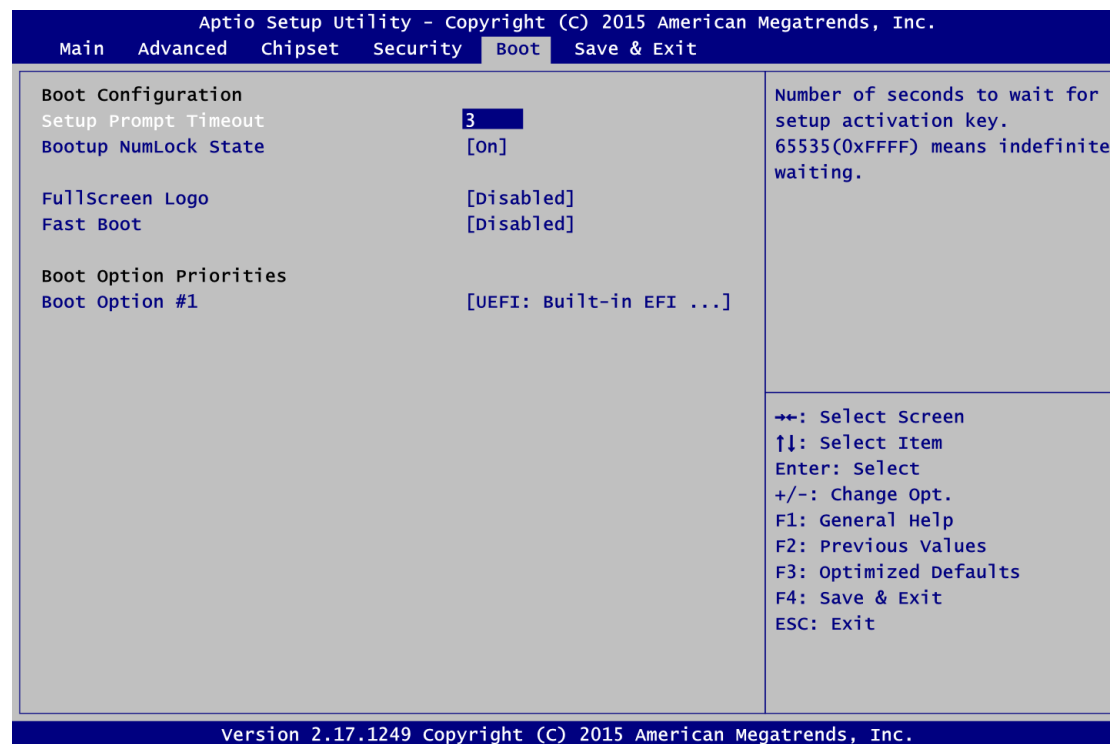

- Setup Prompt Timeout**
 Number of seconds to wait for setup activation key. 65535(0xFFFF) means indefinite waiting.
- Bootup NumLock State**
 Use this item to select the power-on state for the keyboard NumLock.
- FullScreen Logo**
 Enable or disable OEM logo display at system startup.
- Fast Boot**
 Enable or disable fast boot function. BIOS skips some certain procedures to decrease system boot up time.
- Boot Option Priorities [Boot Option #1, ...]**
 These are settings for boot priority. Specify the boot device priority sequence from the available devices.

4.8 Save & Exit Menu

The Save & Exit menu allows users to load your system configuration with optimal or fail-safe default values.

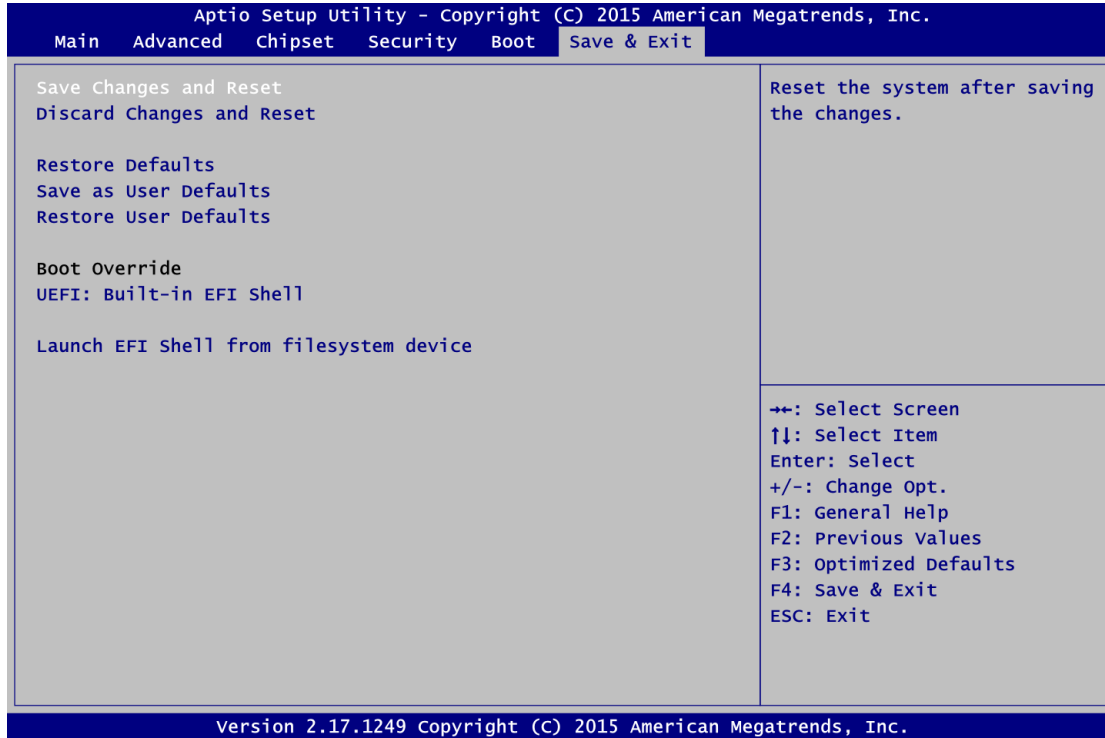

- Save Changes and Reset**

When you have completed the system configuration changes, select this option to leave Setup and reboot the computer so the new system configuration parameters can take effect. Select Save Changes and Reset from the Save & Exit menu and press <Enter>. Select Yes to save changes and reset.
- Discard Changes and Reset**

Select this option to quit Setup without making any permanent changes to the system configuration and reboot the computer. Select Discard Changes and Reset from the Save & Exit menu and press <Enter>. Select Yes to discard changes and reset.
- Restore Defaults**

It automatically sets all Setup options to a complete set of default settings when you select this option. Select Restore Defaults from the Save & Exit menu and press <Enter>.
- Save as User Defaults**

Select this option to save system configuration changes done so far as User Defaults. Select Save as User Defaults from the Save & Exit menu and press <Enter>.
- Restore User Defaults**

It automatically sets all Setup options to a complete set of User Defaults when you select this option. Select Restore User Defaults from the Save & Exit menu and press <Enter>.

- **Boot Override**
Select a drive to immediately boot that device regardless of the current boot order.
- **Launch EFI Shell from filesystem device**
Attempt to launch EFI Shell application (Shellx64.efi) from one of the available filesystem devices.