



®

AXIOMTEK

eBOX670-891-FL Series

Embedded System

User's Manual



Disclaimers

This manual has been carefully checked and believed to contain accurate information. Axiomtek Co., Ltd. assumes no responsibility for any infringements of patents or any third party's rights, or any liability arising from such uses.

Axiomtek does not warrant or assume any legal liability or responsibility for the accuracy, completeness or usefulness of any information in this document. Axiomtek does not make any commitment to update any information in this manual.

Axiomtek reserves the right to change or revise this document and/or product at any time without notice.

No part of this document may be reproduced, stored in a retrieval system, or transmitted in any forms or by any means, electronic, mechanical, photocopying, recording, among others, without prior written permissions of Axiomtek Co., Ltd.

©Copyright 2019 Axiomtek Co., Ltd.

All Rights Reserved

July 2019, Version A4

Printed in Taiwan

Safety Precautions

Before getting started, please read the following important safety precautions.

1. The eBOX670-891-FL does not come with an operating system which must be loaded first before installation of any software into the computer.
2. Be sure to ground yourself to prevent static charge when installing any internal components. Use a wrist grounding strap and place all electronic components in any static-shielded devices. Most electronic components are sensitive to static electrical charge.
3. Disconnect the power cord from the eBOX670-891-FL prior to making any installation. Be sure both the system and all external devices are turned OFF. Sudden surge of power could ruin sensitive components. Make sure the eBOX670-891-FL is properly grounded.
4. Make sure the voltage of the power source is correct before connecting it to any power outlet.
5. Turn Off system power before cleaning. Clean the system using a cloth only. Do not spray any liquid cleaner directly onto the screen.
6. Do not leave equipment in an uncontrolled environment where the storage temperature is below -40°C or above 80°C as it may damage the equipment.
7. Do not open the system's back cover. If opening the cover for maintenance is a must, only a trained technician is allowed to do so. Integrated circuits on computer boards are sensitive to static electricity. To avoid damaging chips from electrostatic discharge, observe the following precautions:
 - Before handling a board or integrated circuit, touch an unpainted portion of the system unit chassis for a few seconds. This will help discharge any static electricity on human body.
 - When handling boards and components, wear a wrist grounding strap available from most electronic component stores.
8. **Caution:** Risk of explosion if battery is replaced by an incorrect type dispose of used batteries according to the instructions.
IL Y A RISQUE D' EXPLOSION SI LA BATTERIE EST
REPLACEE
PER UNE BATTERIE DE TYPE INCORRECT.
METTRE AU REBUT LES BATTERIES USAGEES
CONFORMEMENT AUX INSTRUCTIONS
9. **Warning:**
Hot Surface Do Not Touch.
Restricted access locations: The equipment should only be installed in a
Restricted Access Area.

Classifications

1. Degree of protection against electric shock: not classified
2. Degree of protection against ingress of water: IP40
3. Equipment not suitable for use in the presence of a flammable anesthetic mixture with air, oxygen or nitrous oxide.
4. Mode of operation: Continuous

General Cleaning Tips

Please keep the following precautions in mind while understanding the details fully before and during any cleaning of the computer and any components within.

A piece of dry cloth is ideal to clean the device.

1. Be cautious of any tiny removable components when using a vacuum cleaner to absorb dirt on the floor.
2. Turn the system off before clean up the computer or any components within.
3. Avoid dropping any components inside the computer or getting circuit board damp or wet.
4. For cleaning, be cautious of all kinds of cleaning solvents or chemicals which may cause allergy to certain individuals.
5. Keep foods, drinks or cigarettes away from the computer.

Cleaning Tools:

Although many companies have created products to help improve the process of cleaning computer and peripherals, users can also use house hold items accordingly for cleaning. Listed below are items available for cleaning computer or computer peripherals.

Pay special attention to components requiring designated products for cleaning as mentioned below.

- Cloth: A piece of cloth is the best tool to use when rubbing up a component. Although paper towels or tissues can be used on most hardware as well, it is recommended to use a piece of cloth.
- Water or rubbing alcohol: A piece of cloth may be somewhat moistened with water or rubbing alcohol before being rubbed on the computer. Unknown solvents may be harmful to plastic parts.
- Absorb dust, dirt, hair, cigarette and other particles outside of a computer can be one of the best methods of cleaning a computer. Over time these items may restrict the airflow in a computer and cause circuitry to corrode.
- Cotton swabs: Cotton swaps moistened with rubbing alcohol or water are applicable to reach areas in keyboard, mouse and other areas.
- Foam swabs: If possible, it is better to use lint free swabs such as foam swabs.



【Note】 : *It is strongly recommended that customer should shut down the system before start to clean any single components.*

Please follow the steps below:

1. Close all application programs;
2. Close operating software;
3. Turn off power switch;
4. Remove all devices;
5. Pull out power cable.

Scrap Computer Recycling

Please inform the nearest Axiomtek distributor as soon as possible for suitable solutions in case computers require maintenance or repair; or for recycling in case computers are out of order.

Trademarks Acknowledgments

Axiomtek is a trademark of Axiomtek Co., Ltd.

IBM, PC/AT, PS/2, VGA are trademarks of International Business Machines Corporation. Intel[®] and Pentium[®] are registered trademarks of Intel Corporation.

MS-DOS, Microsoft C and QuickBasic, Windows 10, Windows 8.1, Windows 8, Windows 7, Windows XPE, Windows XP, Windows CE embedded, Linux are trademarks of Microsoft Corporation.

Other brand names and trademarks are the properties and registered brands of their respective owners.

Table of Contents

Disclaimers.....	ii
Safety Precautions.....	iii
Classifications.....	iv
General Cleaning Tips	v
Scrap Computer Recycling.....	vi
SECTION 1 INTRODUCTION	1
1.1 General Descriptions.....	1
1.2 System Specifications	2
1.2.1 CPU	2
1.2.2 I/O System	3
1.2.3 System Specifications.....	4
1.2.4 Driver CD Contents.....	4
1.3 Dimensions	5
1.3.1 System Dimensions.....	5
1.3.2 Wall-mount Bracket Dimensions.....	6
1.5 Packing List.....	10
1.6 Model List.....	10
SECTION 2 HARDWARE INSTALLATION.....	11
2.1 Installation of CPU.....	11
2.2 Installation of 2.5" SATA Device	14
2.3 Installation of SO-DIMM.....	16
2.4 Installation of CFast™ Module	18
2.5 Installation of Mini PCIe Module (full-size)	19
2.6 Installation of Flexible I/O Modules	20
SECTION 3 JUMPER & CONNECTOR SETTINGS	23
3.1 Locations of Jumpers & Connectors.....	23
3.2 Summary of Jumper Settings	25
3.2.1 Restore BIOS Optimal Defaults (JP1)	25
3.3 Connectors	26
3.3.1 DC-in Phoenix Power Connector	27
3.3.2 HDMI Connector.....	27
3.3.3 DisplayPort Connector	28
3.3.4 Serial Port Connector (COM 1~COM 4)	28
3.3.5 USB 3.0 Connector	29
3.3.6 Ethernet Connector (LAN1~LAN4)	29
3.3.7 USB 2.0 Connector	30
3.3.8 Audio Connector	30
3.3.9 Digital I/O	31
3.3.10 ATX Power On/OFF	32
3.3.11 Reset Button	32
3.3.12 Remote Power Switch Connector	32
3.3.13 AT/ATX Switch	32
3.3.14 CFast™ Socket	33

3.3.15	SATA Connector (SATA 1 & 2)	34
3.3.16	SATA Power Connector	34
3.3.17	SIM Card Slots (SCN1)	34
3.3.18	Full-Size PCI Express Mini Card Slot (SCN2 & SCN3)	35
SECTION 4	BIOS SETUP UTILITY	37
4.1	Starting	37
4.2	Navigation Keys	37
4.3	Main Menu	38
4.4	Advanced Menu	39
4.5	Chipset Menu	55
4.6	Boot Menu	60
4.7	Save & Exit Menu	61
APPENDIX A	WATCHDOG TIMER	63
	About Watchdog Timer	63
	Sample Program	64
APPENDIX B	PROGRAMMABLE LED	65
APPENDIX C	PROGRAMMABLE DIGITAL I/O	67
APPENDIX D	CONFIGURING SATA FOR RAID	69
D.1	Configuring SATA Hard Drive(s) for RAID	69
APPENDIX E	iAMT SETTINGS	77
E.1	Entering MEBx	77
E.2	Set and Change Password	77
E.3	iAMT Settings	79
E.4	iAMT Web Console	82

SECTION 1 INTRODUCTION



This section contains general information and detailed specifications of the eBOX670-891-FL. Section 1 consists of the following sub-sections:

- General Descriptions
- System Specifications
- Dimensions
- I/O Outlets
- Packing List
- Model List

1.1 General Descriptions

A fanless embedded system with 7th / 6th generation Intel® Core™ i7/i5/i3 and Celeron® processor (formally codename: Kaby Lake / Skylake) processor with flexible I/O design. To fulfill different application needs, the flexible embedded system supports WE8S, WES7, Windows® 10 and Linux, and it can be wall-mounted and Din-rail mounted by optional requests.

The eBOX670-891-FL is built with an IP40-rated heavy-duty aluminum extrusion, enabling reliable operation in harsh environments. Moreover, a wide range 9 to 36V DC power input with power protection, -40°C to +60°C extended temperature. To highly reduce deployment time, this fanless embedded PC supports one optional I/O door for customers to easily install additional I/O output. It is perfectly suitable for any industrial grade applications.

Features

- LGA1151 socket 7th / 6th generation Intel® Core™ i7/i5/i3 & Celeron® processor (Kaby Lake / Skylake) with Intel® Q170
- Supports Jumbo Frame (9.5k), WoL, PXE Remote Boot, Teaming
- Wide range of DC power input supported from 9 to 36VDC
- One DisplayPort and two HDMI (one HDMI 2.0) with triple view supported
- Various of flexible I/O modules supported

Reliable and Stable Design

The embedded system supports 7th / 6th generation Intel® Core™ i7/i5/i3 and Celeron® processors, high flexibility and multi-functional design is the best solution for any industrial field applications.

Flexible Connectivity

It comes with rich I/O interfaces including four RS-232/422/485 ports, six USB 3.0 ports, two USB 2.0 ports, 32-CH digital I/O, four GbE LAN ports.

Embedded O.S. Supported

The eBOX670-891-FL with 6th platform supports WES7, Linux; 7th platform only support Windows® 10 64 Bit.

Various Storage Supported

In terms of storage, the eBOX670-891-FL supports two 2.5" SATA storage drive bay, one CFast™ and one mSATA device.

1.2 System Specifications

1.2.1 CPU

- **CPU**
 - LGA1151 socket 7th / 6th generation Intel® Core™ i7/i5/i3 & Celeron® processor, CPU TDP max. up to 35W
 - Intel® Core™ i7-6700TE/ 7700T processor
 - Intel® Core™ i5-6500TE/ 7500T processor
 - Intel® Core™ i3-6100TE/ 7101TE processor
 - Intel® Celeron® G3900TE / G4400TE processor
- **Chipset**
 - Intel® Q170
- **BIOS**
 - American Megatrends Inc. UEFI (Unified Extensible Firmware Interface) BIOS.
- **System Memory**
 - Two 260-pin unbuffered DDR4-2133 MHz SO-DIMM socket, up to 32 GB at the maximum for 6th generation Intel® Core™ processor
 - Two 260-pin unbuffered DDR4-2400 MHz SO-DIMM socket, up to 32 GB at the maximum for 7th generation Intel® Core™ processor

1.2.2 I/O System

- **Display**
 - 2 x HDMI
(1 x HDMI 2.0 Resolution:4K/2K@60Hz & 1 x HDMI 1.4b Resolution : 4K/2K@30Hz)
 - 1 x DisplayPort (Resolution:4K/2K@60Hz)
- **Ethernet**
 - 4 x 10/100/1000 Ethernet ports (3 x i210IT & 1 x i219LM)
- **USB Ports**
 - 2 x USB 2.0
 - 6 x USB 3.0
- **Serial Ports**
 - 4 x RS-232/422/485 (COM1~4)
- **DIO**
 - 1 x 32-channel programmable DI/DO
- **Audio**
 - 1 x Audio (Mic-in/Line-out)
- **Mini PCIe Interface**
 - 2 x full-size PCI Express Mini Card Slots (USB + PCI Express signal)
- **Storage**
 - 2 x 2.5" SATA HDD/SSD drive bay
 - 1 x mSATA (optional)
 - 1 x CFast™
 - 1 x SIM slot
- **Indicator**
 - 1 x Green LED as indicator for PWR status
 - 1 x Orange LED as indicator for HDD active
 - 4 x Green LED as indicator for programmable
- **Switch**
 - 1 x ATX PWR switch
 - 1 x Remote PWR switch
 - 1 x AT/ATX Quick switch
 - 1 x Reset switch
- **Antenna**
 - 4 x SMA type connector openings for antenna

1.2.3 System Specifications

- **Watchdog Timer**
 - 1~255 seconds or minutes; up to 255 levels.
- **Power Supply**
 - 9~36 VDC power input
- **Operation Temperature**
 - -40°C ~+60°C (-40 °F ~ 140°F), with W.T. SSD & Memory : Skylake
 - -40°C ~+55°C (-40 °F ~ 131°F), with W.T. SSD & Memory : Kaby Lake
- **Storage Temperature**
 - -40°C ~+80°C (-40 °F ~ 176°F)
- **Humidity**
 - 10% ~ 95% (non-condensation)
- **Vibration Endurance**
 - 3Grm with CFast™ (5-500Hz, X, Y, Z directions)
- **Weight**
 - 3.8 kg (8.37 lb) without package
 - 4.6 kg (10.14 lb) with package
- **Dimension**
 - 280 mm (11.02") (W) x 190 mm (7.48") (D) x 76 mm (2.99") (H)

1.2.4 Driver CD Contents

- Ethernet
- Chipset
- Graphic
- Serial Port
- USB 3.0
- Intel® ME
- Audio
- User Manual
- Quick Manual



【Note】 : All specifications and images are subject to change without notice.

1.3 Dimensions

The following diagrams show dimensions and outlines of the eBOX670-891-FL.

1.3.1 System Dimensions

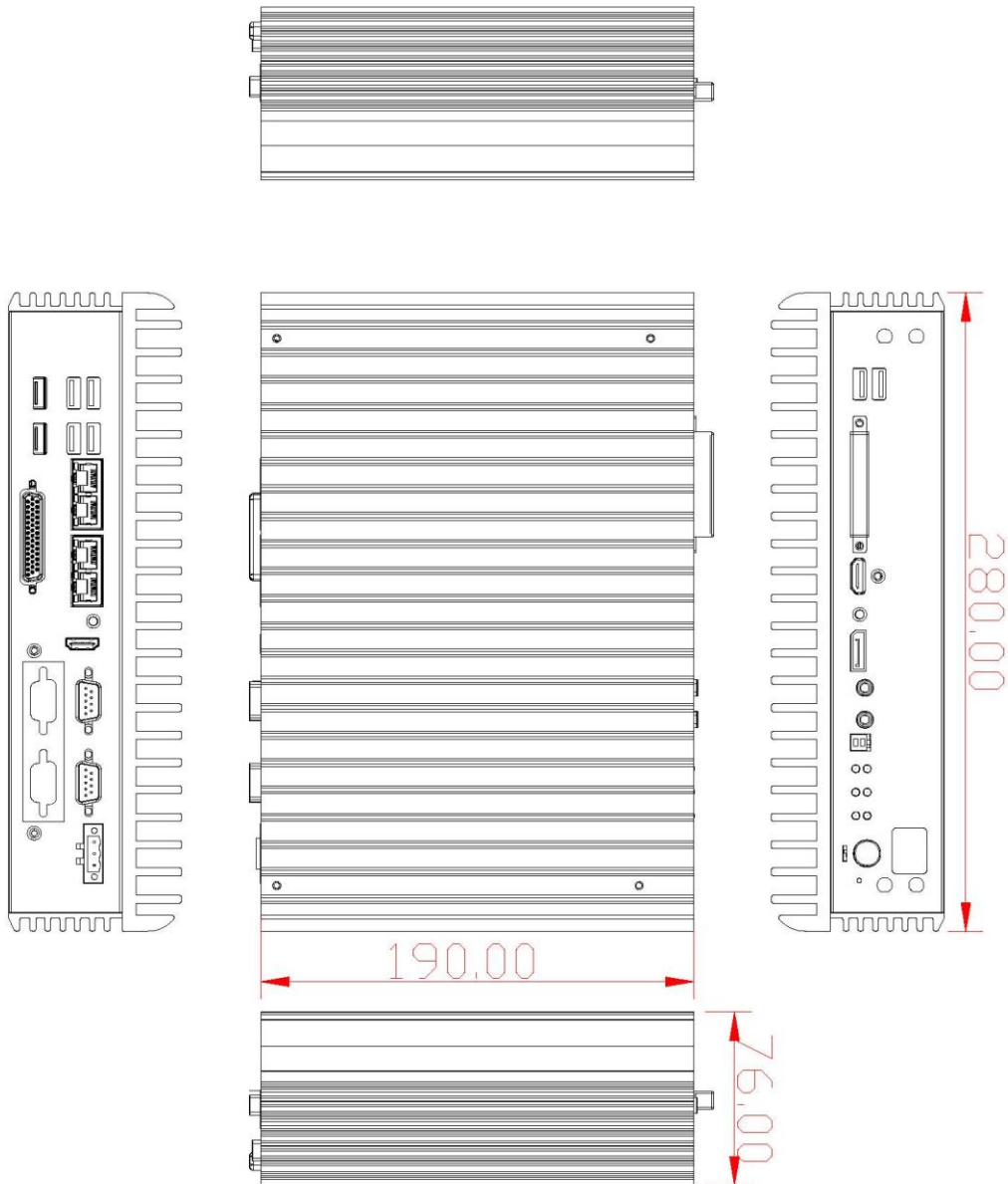

1.3.2 Wall-mount Bracket Dimensions

Users can get 4pcs truss head M3*5L screws to fix the wall-mount kit from accessory box.

Note: When you install Wall-mount kit, please turn the LAN Ports side outlet towards the floor.

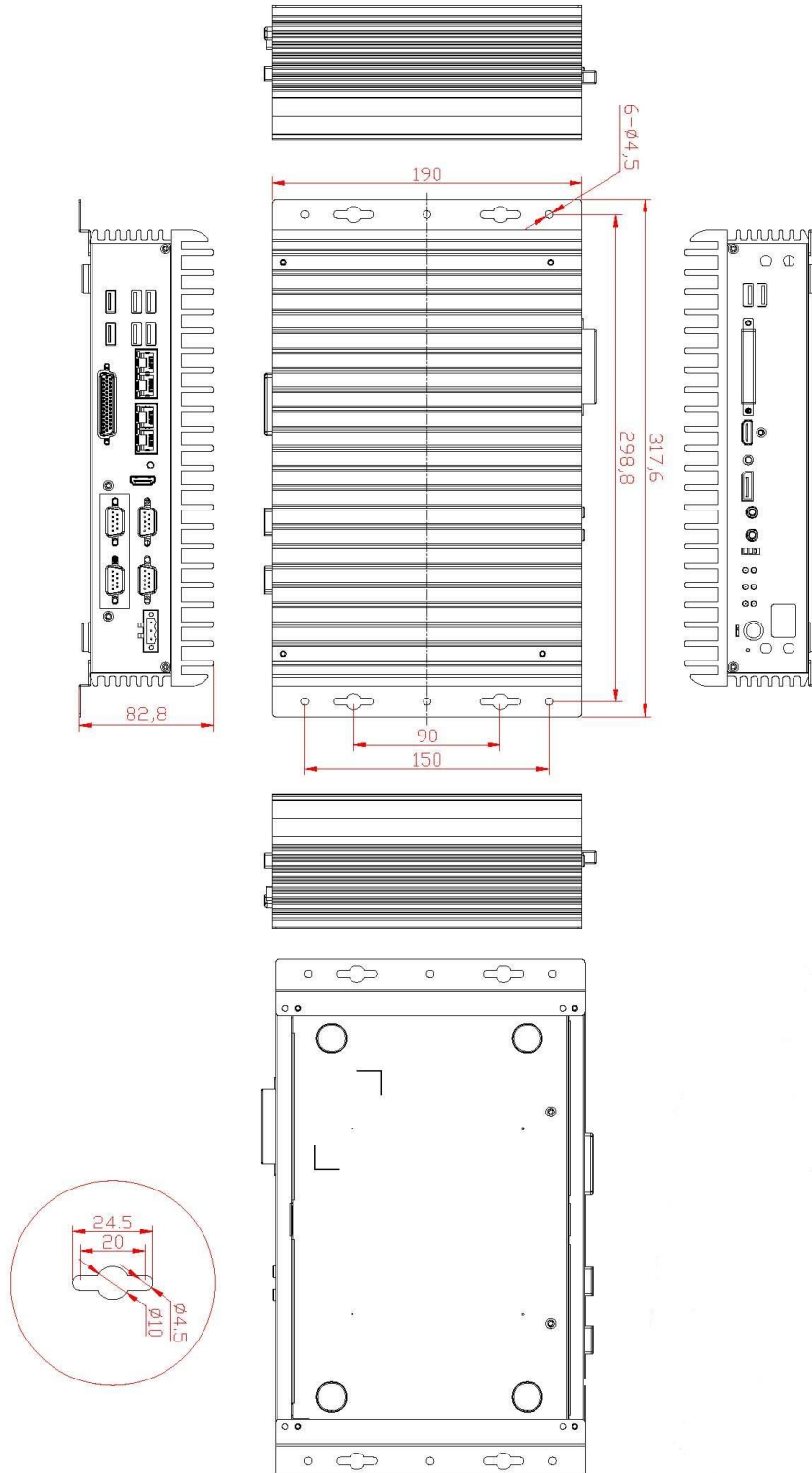

Note: If you install the screws in drywall, use the hollow wall anchors to ensure that unit does not pull away from the wall due to prolonged strain the cable and power connector.

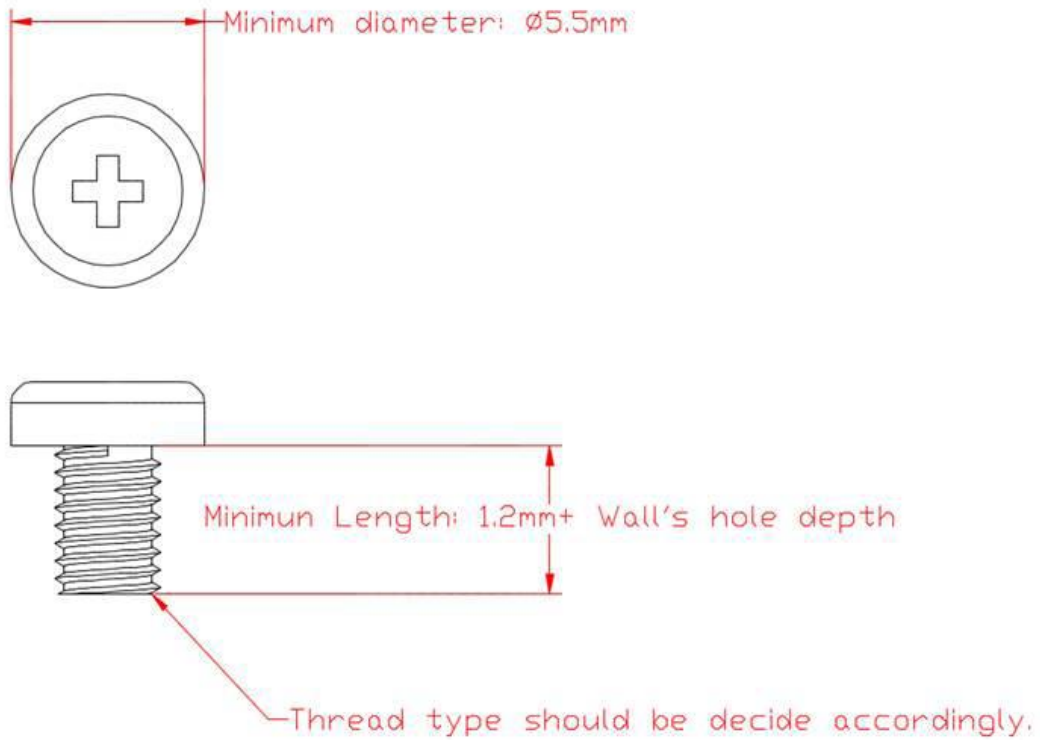

1.3.3 Din rail Bracket Dimensions

Users can get 6pcs flat head M3*4 screws from optional Din-rail kit, please refer to above photos.

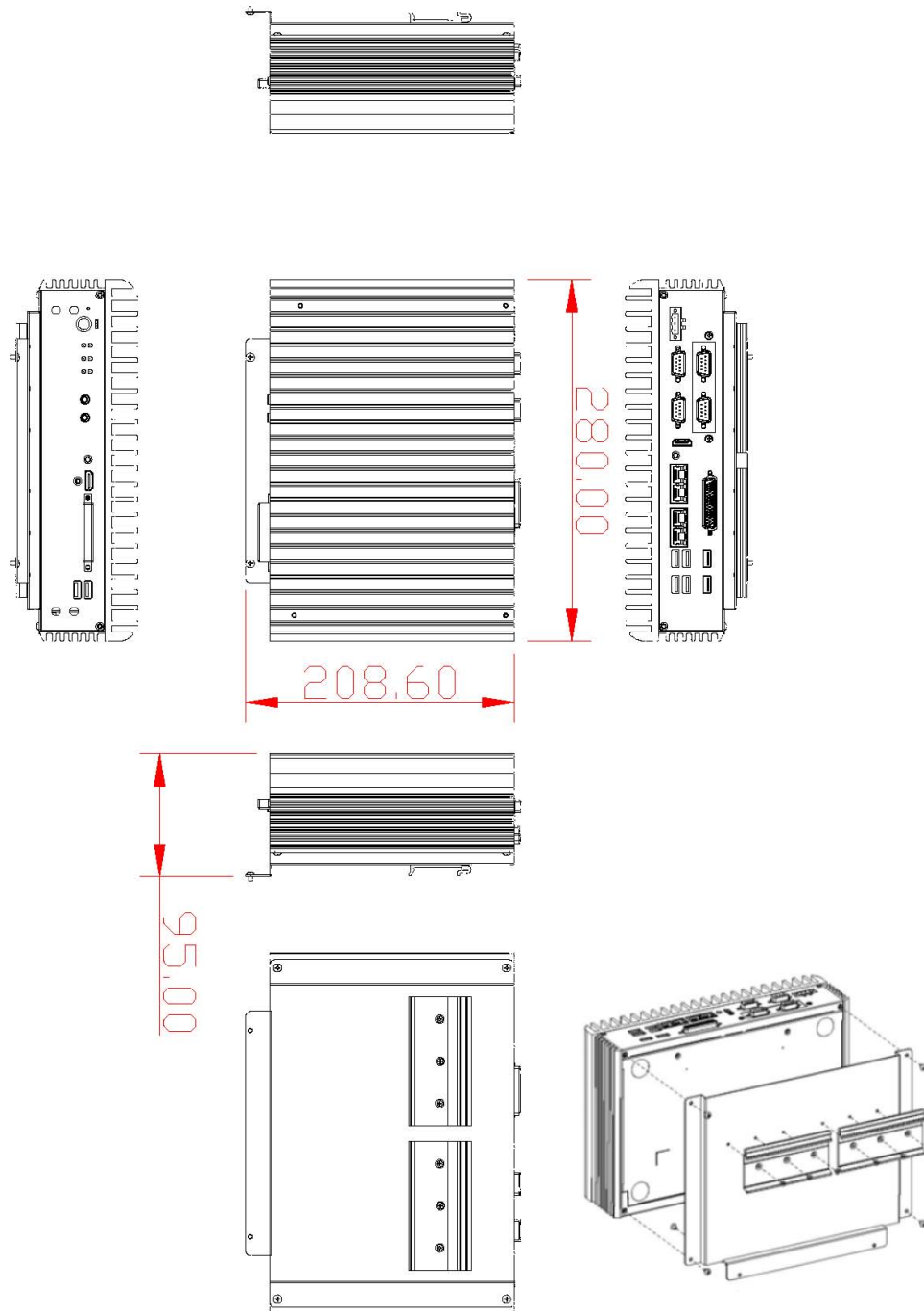

1.4 I/O Outlets

The following figures show I/O outlets on the eBOX670-891-FL.

Front View

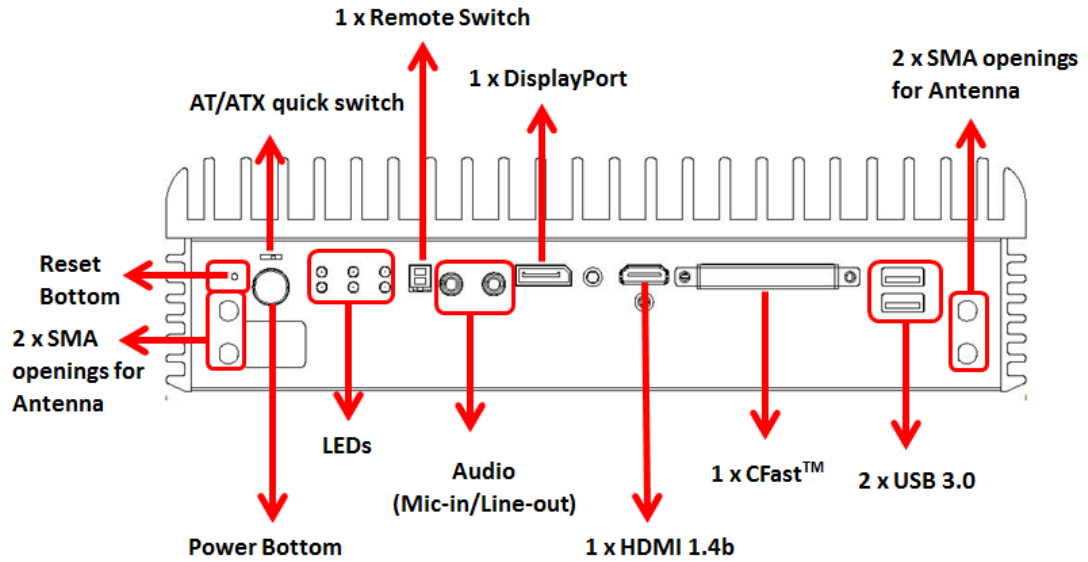

Rear View

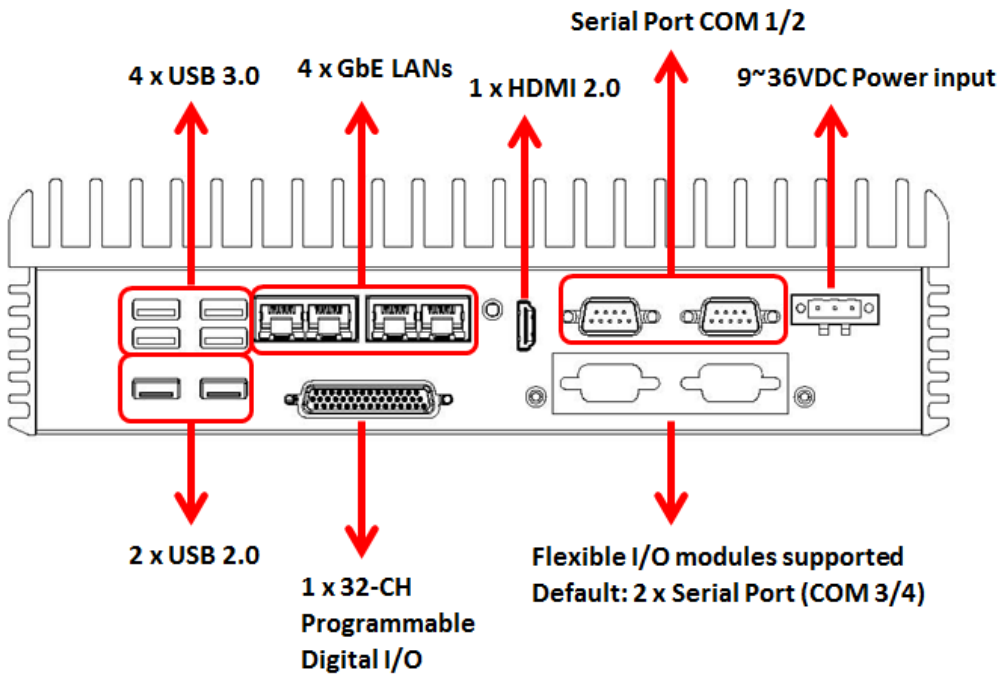

1.5 Packing List

The eBOX670-891-FL comes with the following bundle package:

- eBOX670-891-FL System Unit x 1
- Quick Installation Guide x 1
- DVD x 1 (For Driver and Manual)
- CPU Thermal Pad x 2
- PCH Thermal Pad x 1
- HDD screws x 4
- Terminal Block x 1
- Remote switch cable x 1
- HDD Bracket x 2

1.6 Model List

eBOX670-891-FL-DC	Fanless embedded system with LGA1151 socket 7th /6th generation Intel® Core™ i7/i5/i3 & Celeron® processors, Intel® Q170 chipset, 2 HDMI, 1 DisplayPort, 4 GbE LANs, 6 USB 3.0, CFast™, dual PCI Express Mini Card slots
-------------------	--------------------------------------------------------------------------------------------------------------------------------------------------------------------------------------------------------------------------

Please contact Axiomtek's distributors immediately in case any abovementioned items are missing.

SECTION 2 HARDWARE INSTALLATION

The eBOX670-891-FL is convenient for various hardware configurations, such as CPU, DRAM, HDD (Hard Disk Drive), SSD (Solid State Drive), CFast™ card and PCI Express Mini card modules. Section 2 contains guidelines for hardware installation.

2.1 Installation of CPU

Step 1 Turn off the system and unplug the power cord.

Step 2 Loosen all screws to remove top cover.

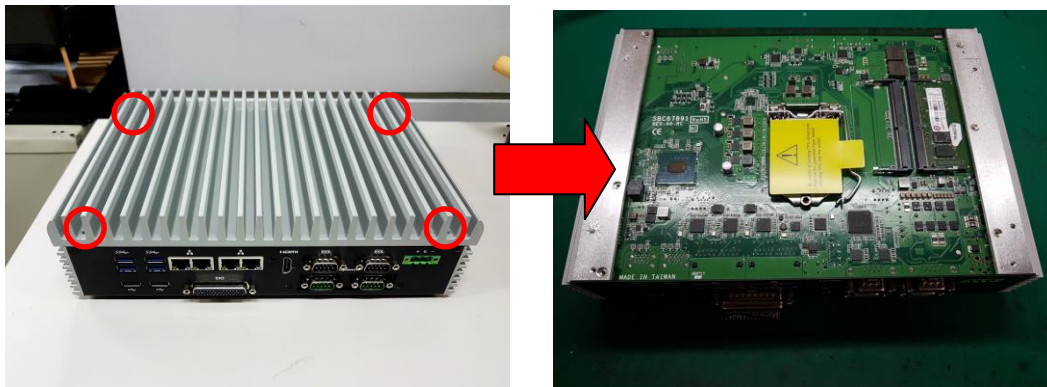

Step 3 Remove the warning label and disengage load lever.

- Disengage load lever by releasing down and out on the hook.
- Rotate load lever to open position at approximately 135°.
- Rotate load plate to open position at approximately 150°.

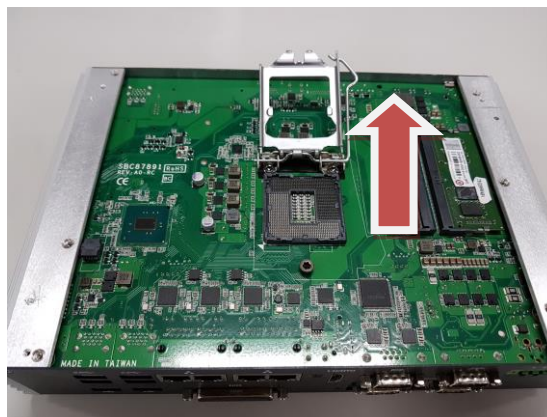

Note

Apply pressure to corner with right-hand thumb when opening or closing load lever - otherwise lever will bounce back (as a mouse trap) causing bent contacts.

Step 4 CPU installation steps:

- Lift processor package from shipping media by grasping the substrate edges.



- Scan the processor package gold pads for any presence of foreign material.
- Locate connection 1 indicator on the processor which aligns with connection 1 indicator chamfer on the socket, and notice processor keying features that line up with posts along socket walls.
- Grasp the processor with thumb and index finger along the top and bottom edges. The socket will have cutouts for your fingers to fit into.
- Carefully place the processor into the socket body vertically.

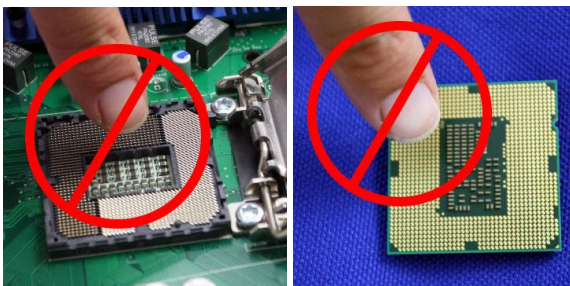
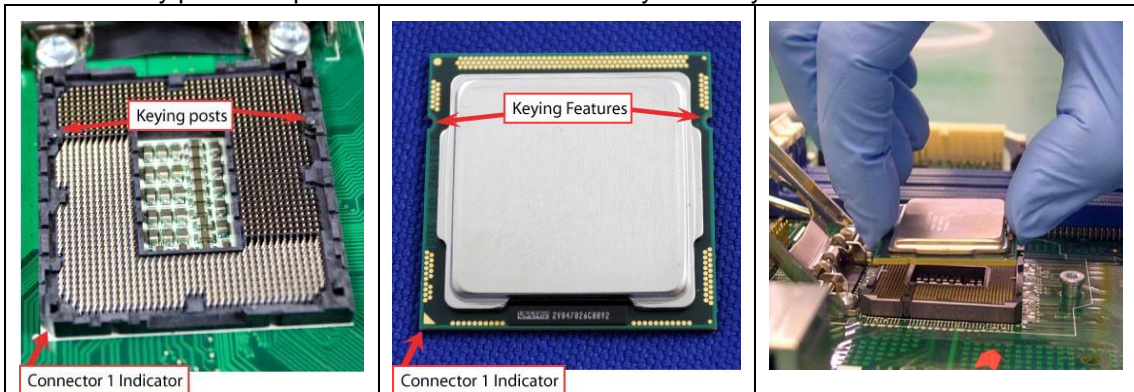

Caution

Never touch fragile socket contacts to avoid damage and do not touch processor sensitive contacts at any time during installation.

Step 5 Align pins of the CPU with pin holes of the socket. Be careful of the CPU's orientation that user's need to align the arrow mark on the CPU with the arrow key on the socket.

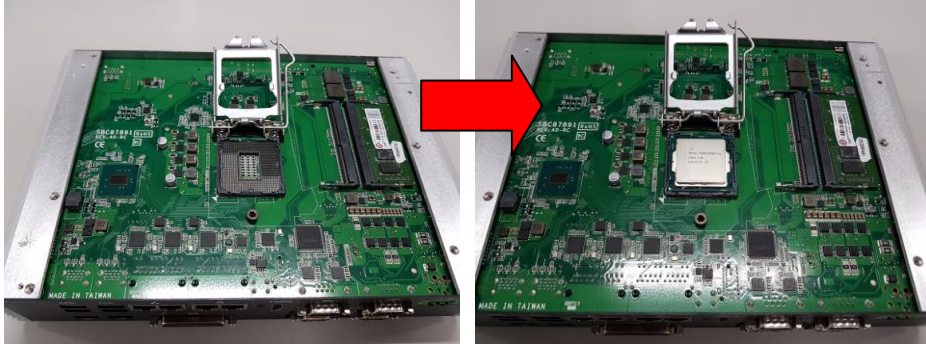

Step 6 Paste the thermal pad on top of the processor with caution, and then remove protection film.

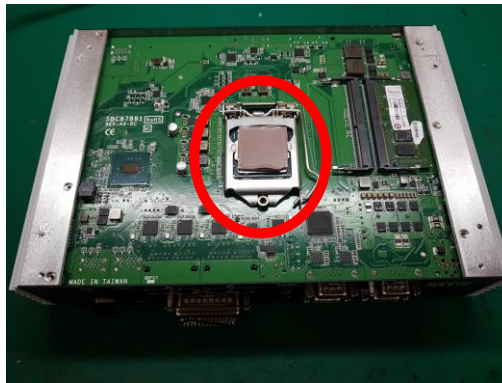

Step 7 Put the top cover and fasten four screws back onto the system.

2.2 Installation of 2.5" SATA Device

Step 1 Turn off the system and unplug the power cord.

Step 2 Turn the system upside down to locate screws at the bottom and then loosen all screws.



Step 3 Open the bottom cover.

Step 4 Locate SSD/HDD within the red line as marked.

Please notice the direction of connector for HDD.



Step 5 Before assemble the SSD/HDD, please loosen the thumb screws to remove two HDD brackets, and then assemble the SSD/HDD with the two HDD mounting screws. Make sure the PCB side of the SSD/HDD will be facing the bottom cover.

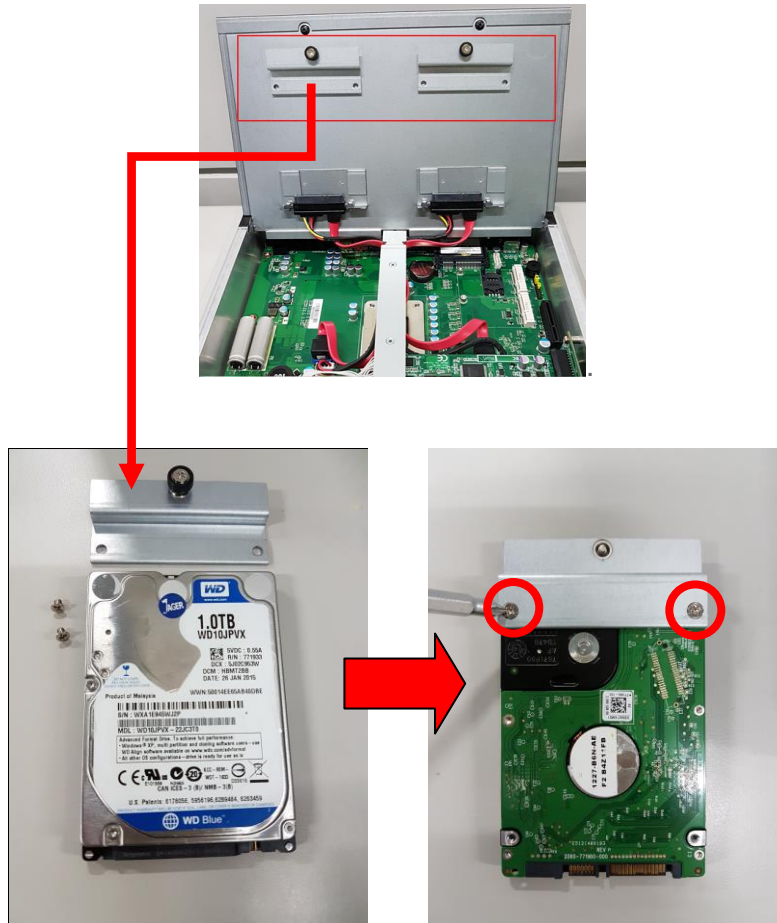

Step 6 Connected the SSD/HDD directly and make sure the insertion is complete.

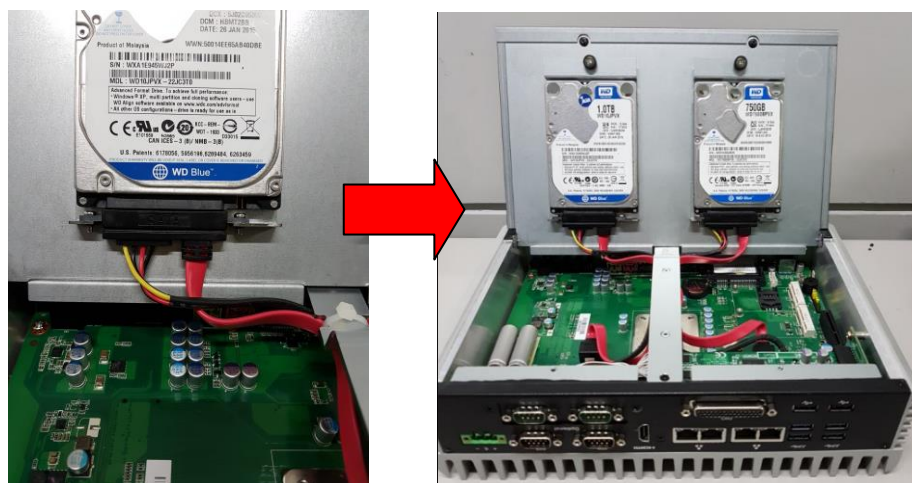

2.3 Installation of SO-DIMM

Step 1 Turn off the system and unplug the power cord.

Step 2 Four screws on the top heatsink are used to fasten the heatsink to the chassis.

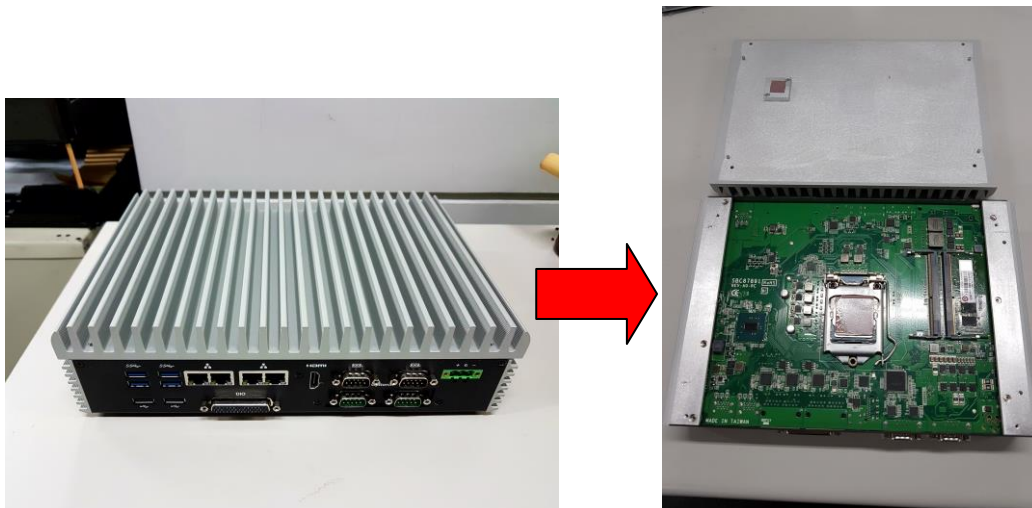

Step 3 Located the dual SO-DIMM sockets on main board.

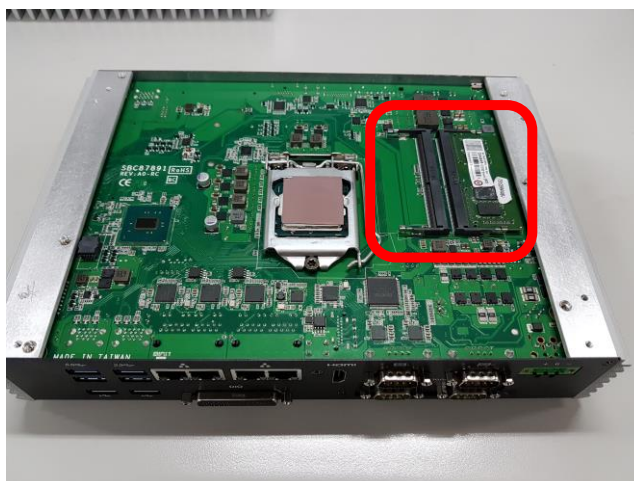

Step 4 Locate the memory module, insert a gold colored contact into the socket and push the module two end latches till locked.

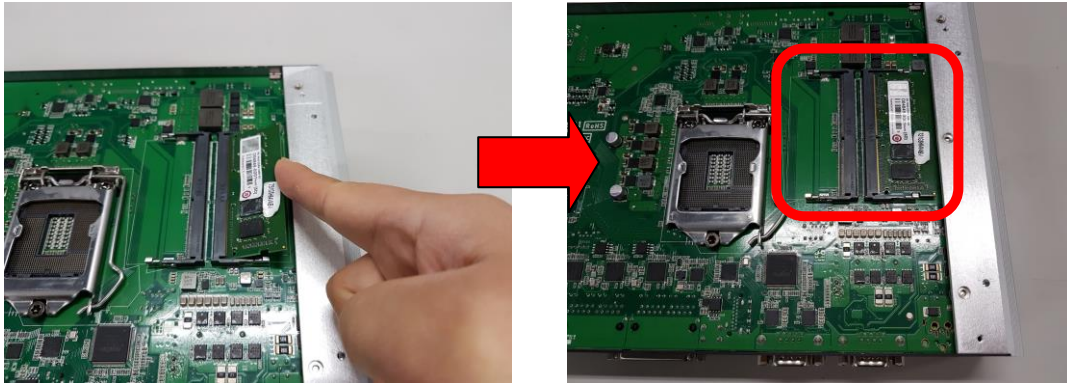

Step 5 Put the top cover and fasten four screws back onto the system.

2.4 Installation of CFast™ Module

Step 1 Turn off the system and unplug the power cord.

Step 2 Located the CFast™ slot on front panel.



Step 3 Insert a CFast™ module into the socket.



Step 4 Recover and fasten all screws of the top cover.

2.5 Installation of Mini PCIe Module (full-size)

- Step 1** Turn off the system and unplug the power cord.
Step 2 Turn the system upside down to locate screws at the bottom, and then loosen all screws.



- Step 3** Identify the two full-size mini PCIe slots, insert a mini PCIe module into the sockets and then fasten all screws.



- Step 4** Put the bottom cover and fasten two screws back onto the system.

2.6 Installation of Flexible I/O Modules

The eBOX670-891 provides an optional window for customer add flexible I/O modules, according to different modules , please refer to quick manual

- LAN Module (RJ45*1)
- DIO Module (DB9*1)
- CAN Bus/CAN Open Module (DB9*2)
- USB Module (USB*1)



Optional Window
(Default: 2 x COM)

Steps 1 Prepare the LAN module kit.



Step 2 Turn off the system and unplug the power cord.

Step 3 Open the bottom cover.

Step 4 Insert the LAN mini PCIe card.



Step 5 Assemble LAN connector with bracket.



Step 6 Connected the cable with the LAN module.

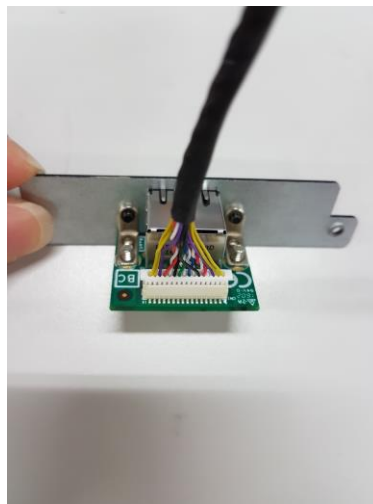

Step 7 Fasten the LAN bracket into the chassis, and then connect the LAN cable to the mini PCIe module.

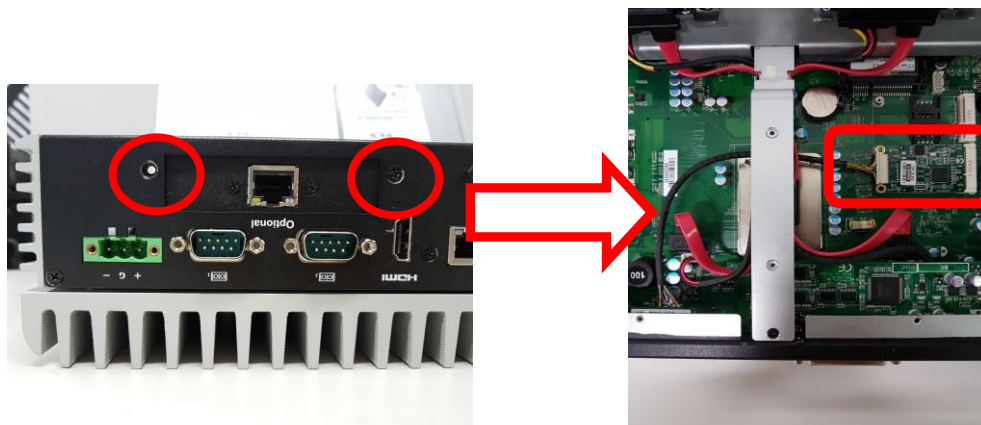

Step 8 Put the bottom cover and fasten two screws back onto the system.

This page is intentionally left blank.

SECTION 3 JUMPER & CONNECTOR SETTINGS

Proper jumper settings configure the eBOX670-891-FL to meet various application needs. Hereby all jumpers settings along with their default settings are listed for devices onboard.

3.1 Locations of Jumpers & Connectors

SBC87891 Top View

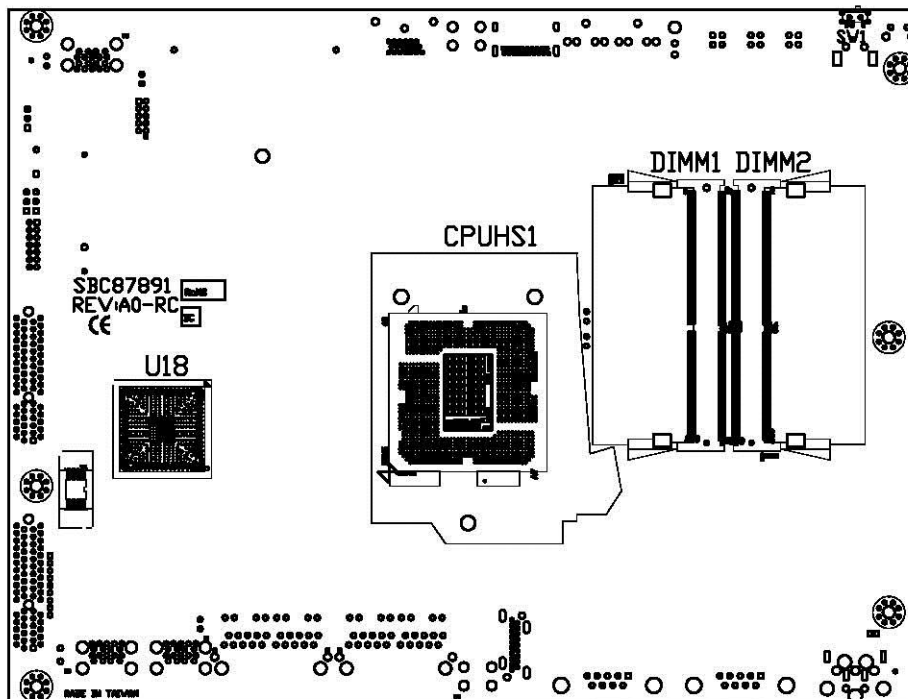

SBC87891 Bottom View

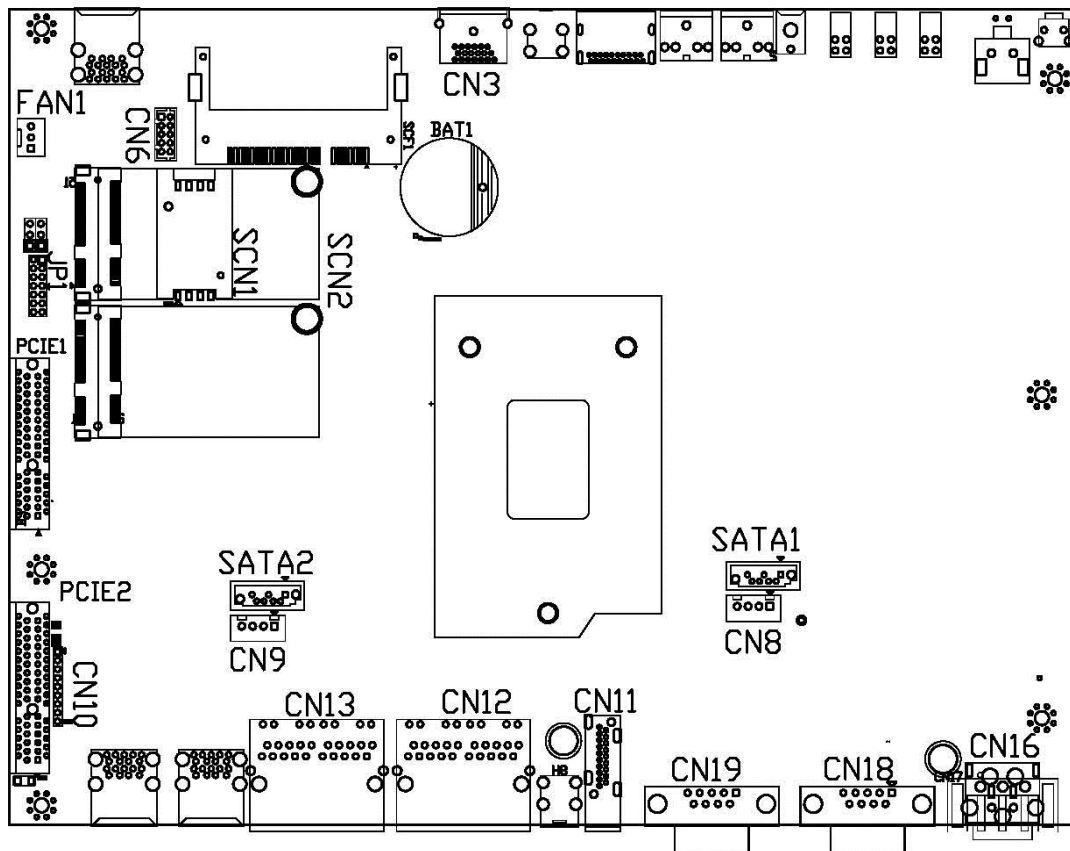

【Note】 : It is strongly recommended that any unmentioned jumper settings should not be modified without instructions by Axiomtek FAEs. Any modifications without instructions might cause system failure.

3.2 Summary of Jumper Settings

Proper jumper settings configure the eBOX670-891-FL to meet various application purposes. A table of all jumpers and their default settings is listed below.

Jumpers	Descriptions	Settings
JP1	Restore BIOS Optimal Defaults Default: Normal Operation	Short 1-2



【Note】 : How to setup Jumpers

That a cap on a jumper is to “close” the jumper, whereas that offs a jumper is to “open” the jumper.



[Open]



[Closed]



[Pin1-2 Closed]

3.2.1 Restore BIOS Optimal Defaults (JP1)

Put jumper clip to pin 2-3 for a few seconds then move it back to pin 1-2. This procedure is to restore BIOS optimal defaults.

Functions	Settings
Normal (Default)	1-2
Clear RTC	2-3

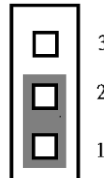

3.3 Connectors

Please refer to pin assignments below:

External Connectors	Sections
DC-in Phoenix Power Connector	3.3.1
HDMI Connector	3.3.2
DisplayPort Connector	3.3.3
Serial Port Connector	3.3.4
USB 3.0 Connector	3.3.5
Ethernet Connector	3.3.6
USB 2.0 Connector	3.3.7
Audio Connector	3.3.8
Digital I/O Connector	3.3.9
ATX Power On/Off Button	3.3.10
Rest Button	3.3.11
Remote Power Switch Connector	3.3.12
AT/ATX Switch	3.3.13
CFast™ Socket	3.3.14
Internal Connectors	Sections
Serial ATA (SATA) Connector	3.3.15
SATA Power Connector	3.3.16
SIM Card Slot (SCN1)	3.3.17
Full-Size Express Mini Card slot (SCN2 & SCN3)	3.3.18

3.3.1 DC-in Phoenix Power Connector

The system supports 9~36V Phoenix DC-in connector for system power input.

Pins	Signals
1	DC+
2	GND
3	DC-

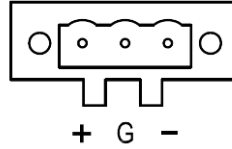

3.3.2 HDMI Connector

The HDMI (High-Definition Multimedia Interface) is a compact digital interface which is capable of transmitting high-definition video and high-resolution audio over a single cable.

Pins	Signals	Pins	Signals
1	HDMI OUT_DATA2+	11	GND
2	GND	12	HDMI OUT Clock-
3	HDMI OUT_DATA2-	13	N.C.
4	HDMI OUT_DATA1+	14	N.C.
5	GND	15	HDMI OUT_SCL
6	HDMI OUT_DATA1-	16	HDMI OUT_SDA
7	HDMI OUT_DATA0+	17	GND
8	GND	18	+5V
9	HDMI OUT_DATA0-	19	HDMI_HTPLG
10	HDMI OUT Clock+		

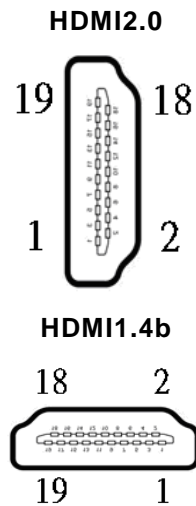

3.3.3 DisplayPort Connector

Pins	Signals	Pins	Signals
1	DPB_LANE0	11	GND
2	GND	12	DPB_LANE3#
3	DPB_LANE0#	13	Detect Pin
4	DPB_LANE1	14	GND
5	GND	15	DPB_AUX
6	DPB_LANE1#	16	GND
7	DPB_LANE2	17	DPB_AUX#
8	GND	18	DPB_HPDE
9	DPB_LANE2#	19	GND
10	DPB_LANE3	20	+3.3V

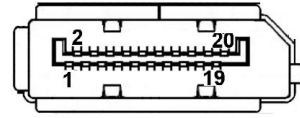

3.3.4 Serial Port Connector (COM 1~COM 4)

The system has four serial ports. COM1~COM4 are RS-232/422/485 ports. Please refer to Chapter 4 for the detail of BIOS setting.

※COM1~4

Pins	RS-232	RS-422	RS-485
1	DCD, Data Carrier Detect	TX-	Data-
2	RXD, Receive Data	TX+	Data+
3	TXD, Transmit Data	RX+	No use
4	DTR, Data Terminal Ready	RX-	No use
5	GND, Ground	No use	No use
6	DSR, Data Set Ready	No use	No use
7	RTS, Request To Send	No use	No use
8	CTS, Clear To Send	No use	No use
9	RI, Ring Indicator	No use	No use

3.3.5 USB 3.0 Connector

The Universal Serial Bus connectors are compliant with USB 3.0 (5 GB/s), and ideally for installing USB peripherals such as scanner, camera and USB devices, etc.

Pins	Signal USB Port 0	Pins	Signal USB Port 1
1	USB_VCC (+5V level standby power)	10	USB_VCC (+5V level standby power)
2	USB_Data-	11	USB_Data-
3	USB_Data+	12	USB_Data+
4	GND	13	GND
5	SSRX-	14	SSRX-
6	SSRX+	15	SSRX+
7	GND	16	GND
8	SSTX-	17	SSTX-
9	SSTX+	18	SSTX+

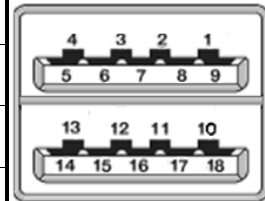

3.3.6 Ethernet Connector (LAN1~LAN4)

The board has four RJ-45 connectors are for LAN1 Ethernet-(Intel i219LM) LAN2-4 Ethernet-(Intel i210-iT).

Pins	LAN Signal	Pins	LAN Signal
L1	MDI0+	L5	MDI2+
L2	MDI0-	L6	MDI2-
L3	MDI1+	L7	MDI3+
L4	MDI1-	L8	MDI3-
A	Activity link LED(Yellow) OFF: No link Blinking: Link established; data activity detected		
B	Speed LED OFF: 10Mbps data rate Green: 100Mbps data rate Orange: 1GMbps data rate		

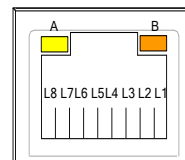

3.3.7 USB 2.0 Connector

The Universal Serial Bus connectors are compliant with USB 2.0 (480Mbps), and ideally for installing USB peripherals such as keyboard, mouse, scanner, etc.

Pins	Signal USB Port
1	USB VCC (+5V level)
2	USB #0_D-
3	USB #0_D+
4	Ground (GND)

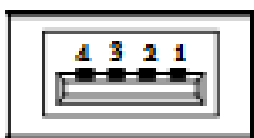

3.3.8 Audio Connector

These two audio jacks ideal are for Audio Mic-In and Audio Line-out.

Pins	Signals
1	Line Out
2	Microphone In

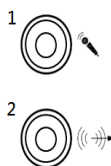

3.3.9 Digital I/O

The system is equipped with 32bit Programmable Digital I/O for 44-pin D-Sub female connectors, please refer to the following table to get default pin define. Default is 16in/16out.

The digital I/O can be configured to control cash drawers and sense warning signals from an Uninterrupted Power System (UPS), or perform store security control. You may use software programming to control these digital signals.

Pins	Signals	Pins	Signals
1	N/A	2	N/A
3	Din	4	Dout
5	Din	6	Dout
7	Din	8	Dout
9	Din	10	Dout
11	Din	12	Dout
13	Din	14	Dout
15	Din	16	Dout
17	Din	18	Dout
19	Din	20	Dout
21	Din	22	Dout
23	Din	24	Dout
25	Din	26	Dout
27	Din	28	Dout
29	Din	30	Dout
31	Din	32	Dout
33	Din	34	Dout
35	GND	36	GND
37	N/A	38	N/A
39	N/A	40	N/A
41	N/A	42	N/A
43	N/A	44	N/A

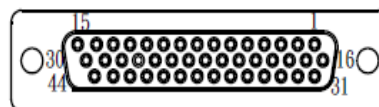

3.3.10 ATX Power On/OFF

The ATX power button is on the I/O side. It can allow users to control eBOX670-891-FL power on/off.

Functions	Descriptions
On	Turn on/off system
Off	Keep system status



3.3.11 Reset Button

The Reset button can allow users to reset eBOX670-891-FL.

Functions	Descriptions
On	Reset system
Off	Keep system status



3.3.12 Remote Power Switch Connector

One 2-pin connector output for remote power on/off switch.

Functions	Descriptions
Short(1-2)	Turn on/off system
Open	Keep system status

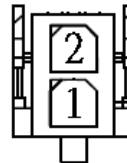

3.3.13 AT/ATX Switch

If you set AT/ATX switch to AT mode, the system will be automatically power on without pressing soft power button during power input; we can use this switch to achieve auto power on demand.

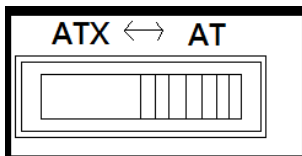

3.3.14 CFast™ Socket

The system is equipped with a CFast™ socket on the bottom side to support a CFast™ card which is based on the Serial ATA bus. The socket is specially designed to avoid incorrect installation of the CFast™ card. When installing or removing the CFast™ card, please make sure the system power is off. The CFast™ card by default identifies itself as C: or D: drive in your PC system.

Pins	Signals	Pins	Signals
S1	GND	PC1	NC
S2	TX+	PC2	GND
S3	TX-	PC3	NC
S4	GND	PC4	NC
S5	RX-	PC5	NC
S6	RX+	PC6	NC
S7	GND	PC7	GND
		PC8	NC
		PC9	NC
		PC10	NC
		PC11	NC
		PC12	NC
		PC13	3.3V
		PC14	3.3V
		PC15	GND
		PC16	GND
		PC17	NC

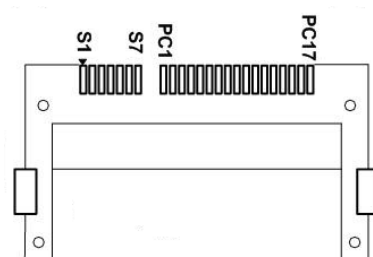

3.3.15 SATA Connector (SATA 1 & 2)

These Serial Advanced Technology Attachment (Serial ATA or SATA) connectors are for high-speed SATA interfaces. They are computer bus interfaces for connecting to devices such as hard disk drives. This board has two SATA 3.0 ports with 6Gb/s performance.

Pins	Signals
1	GND
2	SATA_TX+
3	SATA_TX-
4	GND
5	SATA_RX-
6	SATA_RX+
7	GND

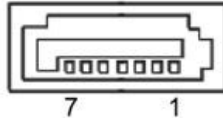

3.3.16 SATA Power Connector

Use CN8、CN9 for interfacing to SATA 2.5" HDD power supply.

Pins	Signals
1	+12V level
2	GND
3	GND
4	+5V level

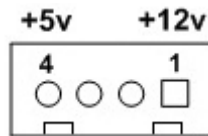

3.3.17 SIM Card Slots (SCN1)

The eBOX670-891-FL includes one SIM slots (SCN1) on the bottom side of the system for inserting SIM Card. It is mainly used in 3G/LTE wireless network application on SCN3.

Pins	Signals
1	PWR
2	RST
3	CLK
4	NC
5	GND
6	VPP
7	I/O
8	NC

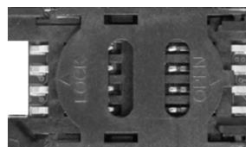
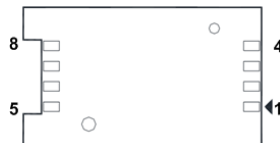

3.3.18 Full-Size PCI Express Mini Card Slot (SCN2 & SCN3)

The eBOX670-891-FL supports dual full-size PCI-Express Mini Card slots. SCN2 is applying to either PCI-Express or USB 2.0 signal, and complies with PCI-Express Mini Card Spec. V1.2.

SCN3 is applying for PCI-Express and SATA (mSATA) signals and complies with PCI-Express Mini Card Spec. V1.2. Thus, users can install mSATA cards into this slot. Please refer to the SATA of BIOS setting to enable or disable mSATA supported

SCN2

Pins	Signals	Pins	Signals
1	WAKE#	2	+3.3VSB
3	No use	4	GND
5	No use	6	+1.5V
7	CLKREQ#	8	No use
9	GND	10	No use
11	REFCLK-	12	No use
13	REFCLK+	14	No use
15	GND	16	No use
17	No use	18	GND
19	No use	20	W_DISABLE#
21	GND	22	PERST#
23	PE_RXN3/	24	+3.3VSB
25	PE_RXP3/	26	GND
27	GND	28	+1.5V
29	GND	30	SMB_CLK
31	PE_TXN3/	32	SMB_DATA
33	PE_TXP3/	34	GND
35	GND	36	USB_D8-
37	GND	38	USB_D8+
39	+3.3VSB	40	GND
41	+3.3VSB	42	No use
43	GND	44	No use
45	No use	46	No use
47	No use	48	+1.5V
49	No use	50	GND
51	No use	52	+3.3VSB

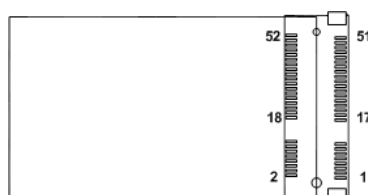

SCN3

Pins	Signals	Pin	Signals
1	WAKE#	2	+3.3VSB
3	No use	4	GND
5	No use	6	+1.5V
7	CLKREQ#	8	No use
9	GND	10	No use
11	REFCLK-	12	No use
13	REFCLK+	14	No use
15	GND	16	No use
17	No use	18	GND
19	No use	20	W_DISABLE#
21	GND	22	PERST#
23	PE_RXN3/mSATA	24	+3.3VSB
25	PE_RXP3/mSATA	26	GND
27	GND	28	+1.5V
29	GND	30	SMB_CLK
31	PE_TXN3/ mSATA	32	SMB_DATA
33	PE_TXP3/ mSATA	34	GND
35	GND	36	USB_D8-
37	GND	38	USB_D8+
39	+3.3VSB	40	GND
41	+3.3VSB	42	No use
43	GND	44	No use
45	No use	46	No use
47	No use	48	+1.5V
49	No use	50	GND
51	No use	52	+3.3VSB

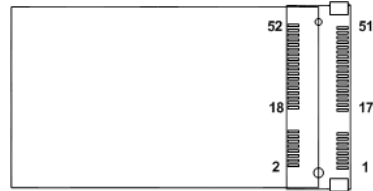

SECTION 4 BIOS SETUP UTILITY

This section provides users with detailed descriptions in terms of how to set up basic system configurations through the BIOS setup utility.

4.1 Starting

To enter the setup screens, follow the steps below:

1. Turn on the computer and press the key immediately.
2. After press the key, the main BIOS setup menu displays. Users can access to other setup screens, such as the Advanced and Chipset menus, from the main BIOS setup menu.

It is strongly recommended that users should avoid changing the chipset's defaults. Both AMI and system manufacturer have carefully set up these defaults that provide the best performance and reliability.

4.2 Navigation Keys

The BIOS setup/utility uses a key-based navigation system called hot keys. Most of the BIOS setup utility hot keys can be used at any time during the setup navigation process. These keys include <F1>, <F2>, <Enter>, <ESC>, <Arrow> keys, and so on.



【Note】 : Some of the navigation keys differ from one screen to another.

Hot Keys	Descriptions
→← Left/Right	The Left and Right <Arrow> keys allow users to select a setup screen.
↑↓ Up/Down	The Up and Down <Arrow> keys allow users to select a setup screen or sub-screen.
+– Plus/Minus	The Plus and Minus <Arrow> keys allow users to change the field value of a particular setup item.
Tab	The <Tab> key allows users to select setup fields.
F1	The <F1> key allows users to display the General Help screen.
F2	The <F2> key allows users to Load Previous Values.
F3	The <F3> key allows users to Load Optimized Defaults.
F4	The <F4> key allows users to save any changes they made and exit the Setup. Press the <F4> key to save any changes.
Esc	The <Esc> key allows users to discard any changes they made and exit the Setup. Press the <Esc> key to exit the setup without saving any changes.
Enter	The <Enter> key allows users to display or change the setup option listed for a particular setup item. The <Enter> key can also allow users to display the setup sub- screens.

4.3 Main Menu

The Main Menu screen is the first screen users see when entering the setup utility. Users can always return to the Main setup screen by selecting the Main tab. System Time/Date can be set up as described below. The Main BIOS setup screen is also shown below.

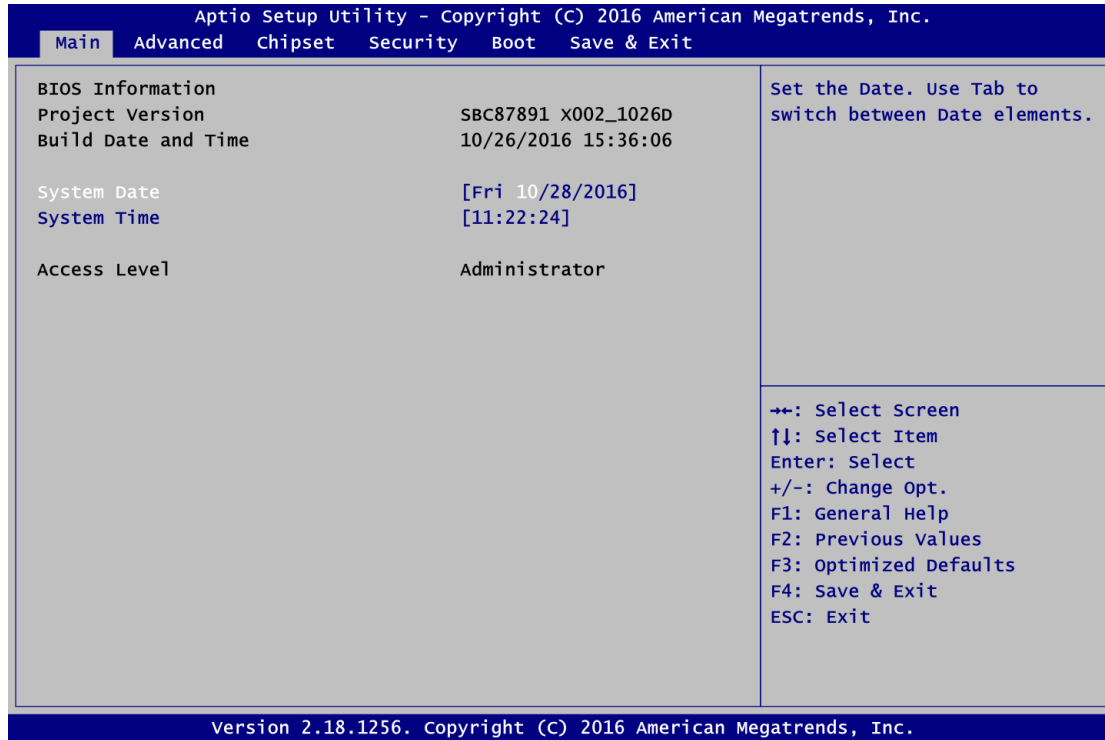

BIOS Information

Display the auto-detected BIOS information.

System Language

Choose the system default language.

System Date/Time

Use this option to change the system time and date. Highlight System Time or System Date using the <Arrow> keys. Enter new values through the keyboard. Press the <Tab> key or the <Arrow> keys to move between fields. The date must be entered in MM/DD/YY format. The time is entered in HH:MM:SS format.

Access Level

Display the access level of current user.

4.4 Advanced Menu

The Advanced menu also allows users to set configuration of the CPU and other system devices. Users can select any items in the left frame of the screen to go to sub menus:

- ▶ Mini Card Switch
- ▶ ACPI Settings
- ▶ CPU Configurations
- ▶ SATA Configurations
- ▶ PCH-FW Configurations
- ▶ AMT Configurations
- ▶ USB Computing
- ▶ NCT6102D Super IO Configurations
- ▶ NCT6106DSEC Super IO Configurations
- ▶ Hardware Monitor
- ▶ Utility Configurations

For items marked with “▶”, please press <Enter> for more options.

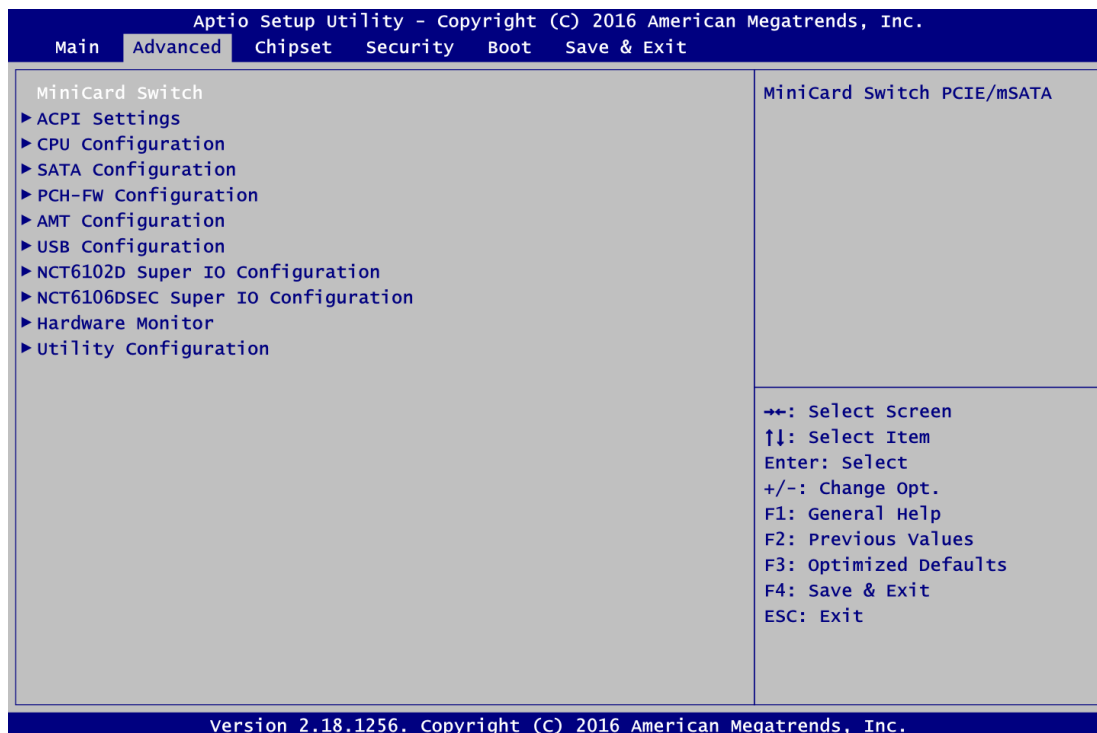

Mini Card Switch

Use this to select Mini Card setting, default is "PCIE".

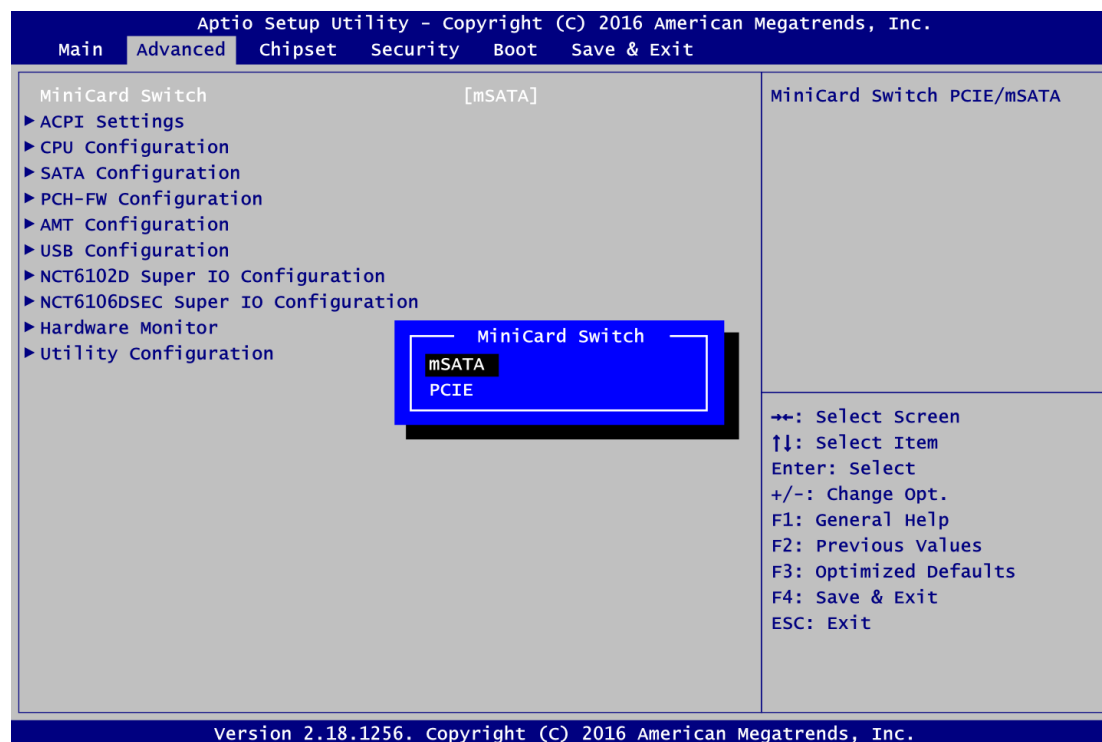

ACPI Settings

Use this screen to select options for the ACPI configuration, and change the value of the selected option. A description of the selected item appears on the right side of the screen.

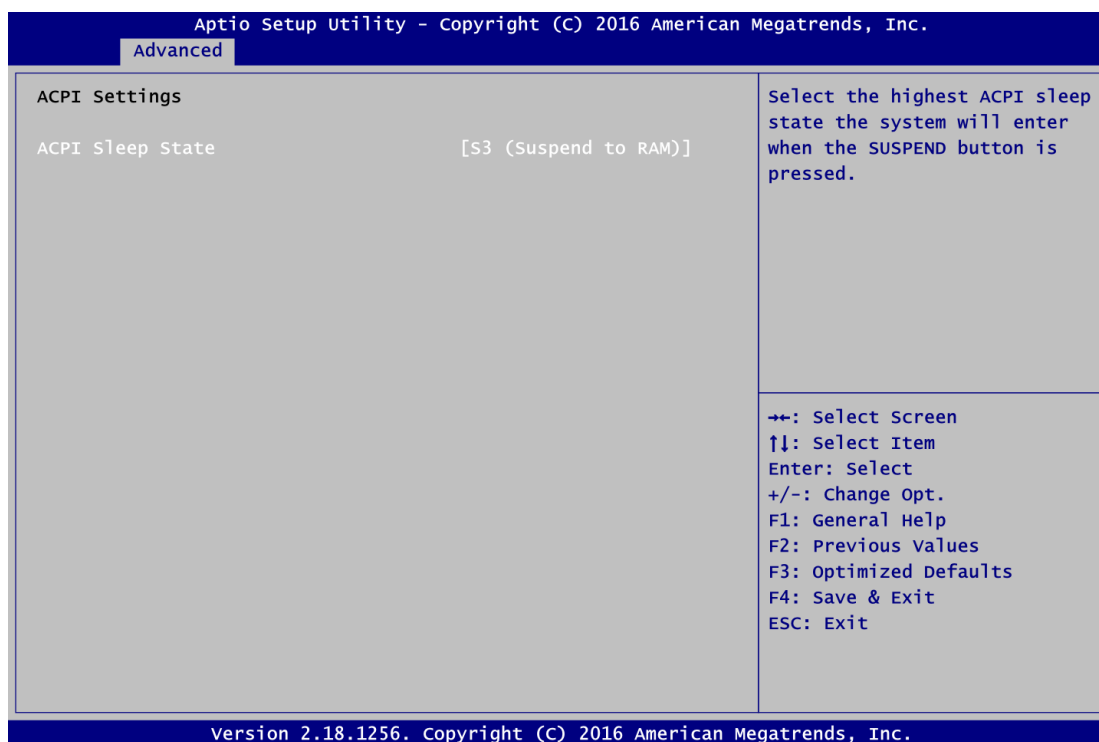

ACPI Sleep State

When the sleep button is pressed, the system will be in the ACPI sleep state.

The default is S3 (Suspend to RAM).

CPU Configurations

This screen shows the CPU version and its detailed information.

The screenshot displays the 'Advanced' menu of the Aptio Setup Utility. The main content area is titled 'CPU Configuration' and lists various processor features and their status. On the right side, there is a descriptive note about Vanderpool Technology and a list of navigation keys. The bottom of the screen shows the version number 'Version 2.18.1256. Copyright (C) 2016 American Megatrends, Inc.'

CPU Configuration	
Intel(R) Core(TM) i5-6500TE CPU @ 2.30GHz	
CPU Signature	506E3
Microcode Patch	8A
Processor Cores	4
Hyper Threading Technology	Not Supported
Intel VT-x Technology	Supported
Intel SMX Technology	Supported
64-bit	Supported
EIST Technology	Supported
L1 Data Cache	32 kB x 4
L1 Code Cache	32 kB x 4
L2 Cache	256 kB x 2
L3 Cache	6 MB
Intel Virtualization Technology	[Enabled]

When enabled, a VMM can utilize the additional hardware capabilities provided by Vanderpool Technology

←+: Select Screen
↑↓: Select Item
Enter: Select
+/-: Change Opt.
F1: General Help
F2: Previous Values
F3: Optimized Defaults
F4: Save & Exit
ESC: Exit

Version 2.18.1256. Copyright (C) 2016 American Megatrends, Inc.

Intel Virtualization Technology

It allows a hardware platform to run multiple operating systems separately and simultaneously, enabling one system to virtually function as several systems.

SATA Configurations

In this Configuration menu, you can see the currently installed hardware in the SATA ports. During system boot up, the BIOS automatically detects the presence of SATA devices.

Aptio Setup Utility - Copyright (C) 2016 American Megatrends, Inc.

Advanced

SATA Controller(s)	[Enabled]	Enable or disable SATA Device.
SATA Mode Selection	[AHCI]	
Serial ATA Port 0	WDC WD10JPVX-2 (1000.2GB)	
Serial ATA Port 1	WDC WD7500BPVX (750.1GB)	
Serial ATA Port 2	Empty	
Serial ATA Port 3	CFast 3ME (32.0GB)	

→+: Select Screen
↑↓: Select Item
Enter: Select
+/-: Change Opt.
F1: General Help
F2: Previous Values
F3: Optimized Defaults
F4: Save & Exit
ESC: Exit

Version 2.18.1256. Copyright (C) 2016 American Megatrends, Inc.

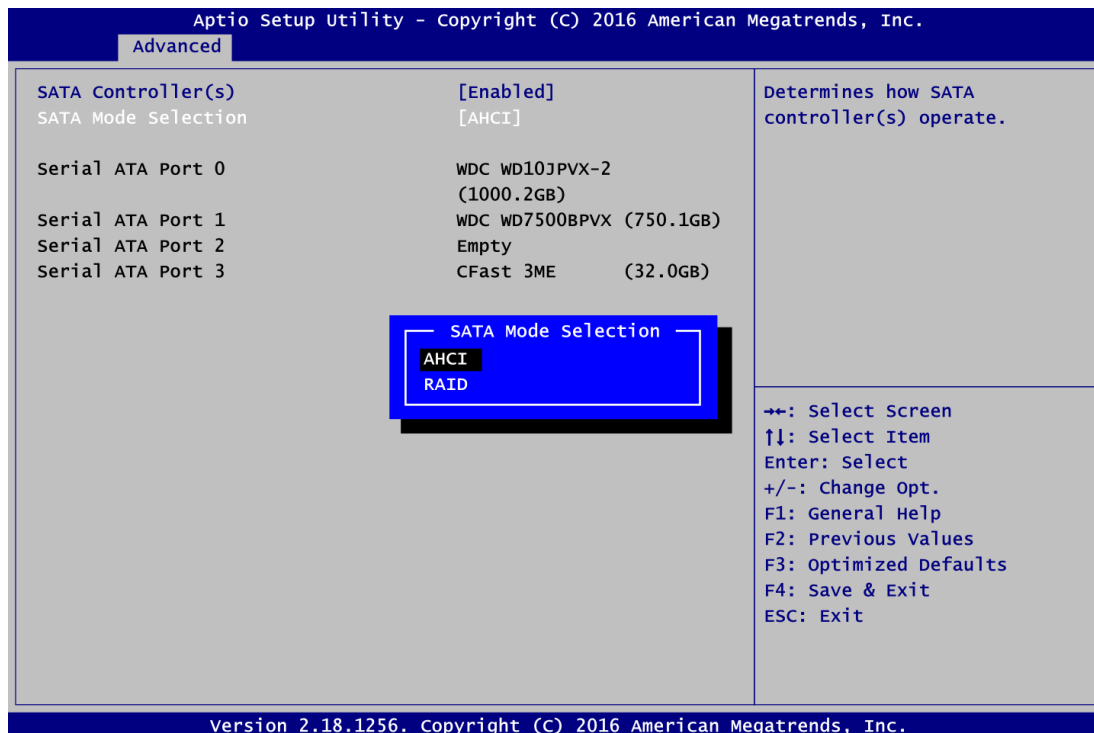
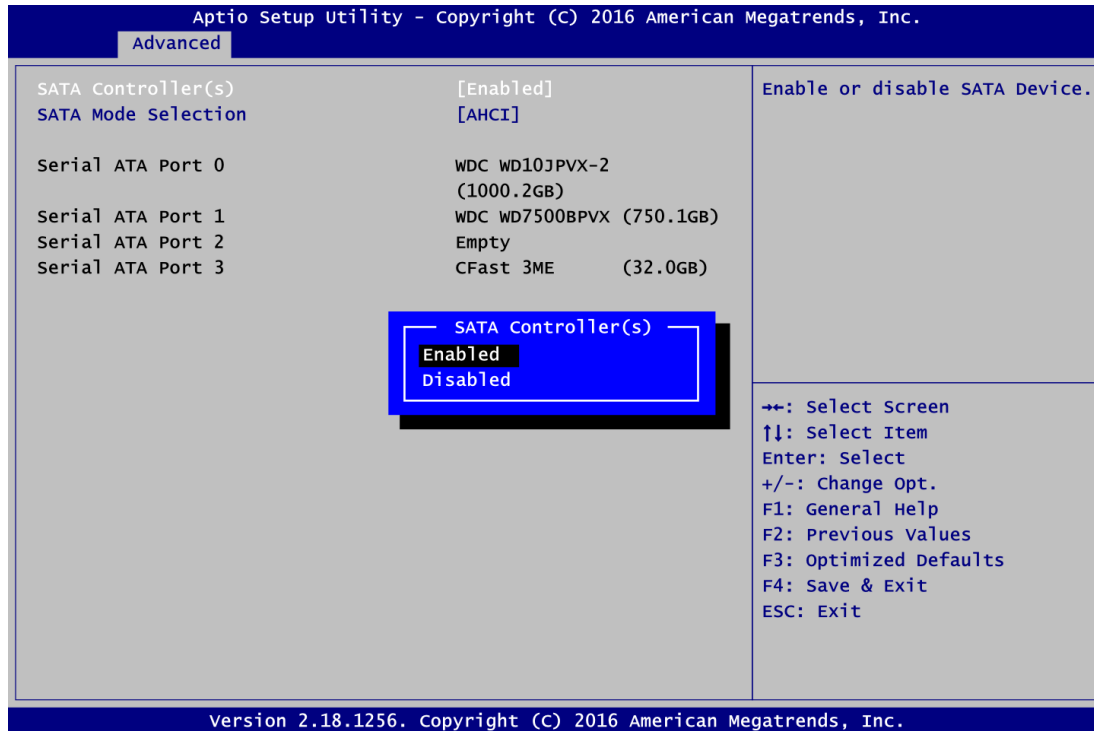

SATA Mode Selection

AHCI (Advanced Host Controller Interface) mode is how SATA controller(s) operate.

Serial ATA Port 0~3

It shows the device installed in connector SATA0~3

PCH-FW Configuration

This screen shows ME Firmware information.

Aptio Setup Utility - Copyright (C) 2016 American Megatrends, Inc.

Advanced

ME FW Version	11.0.10.1002
ME Firmware Mode	Normal Mode
ME Firmware Type	Full Sku Firmware
ME Firmware SKU	Corporate SKU

→: Select Screen
↑↓: Select Item
Enter: Select
+/-: Change Opt.
F1: General Help
F2: Previous Values
F3: Optimized Defaults
F4: Save & Exit
ESC: Exit

Version 2.18.1256. Copyright (C) 2016 American Megatrends, Inc.

AMT Configurations

User can use this screen to configure AMT parameters.

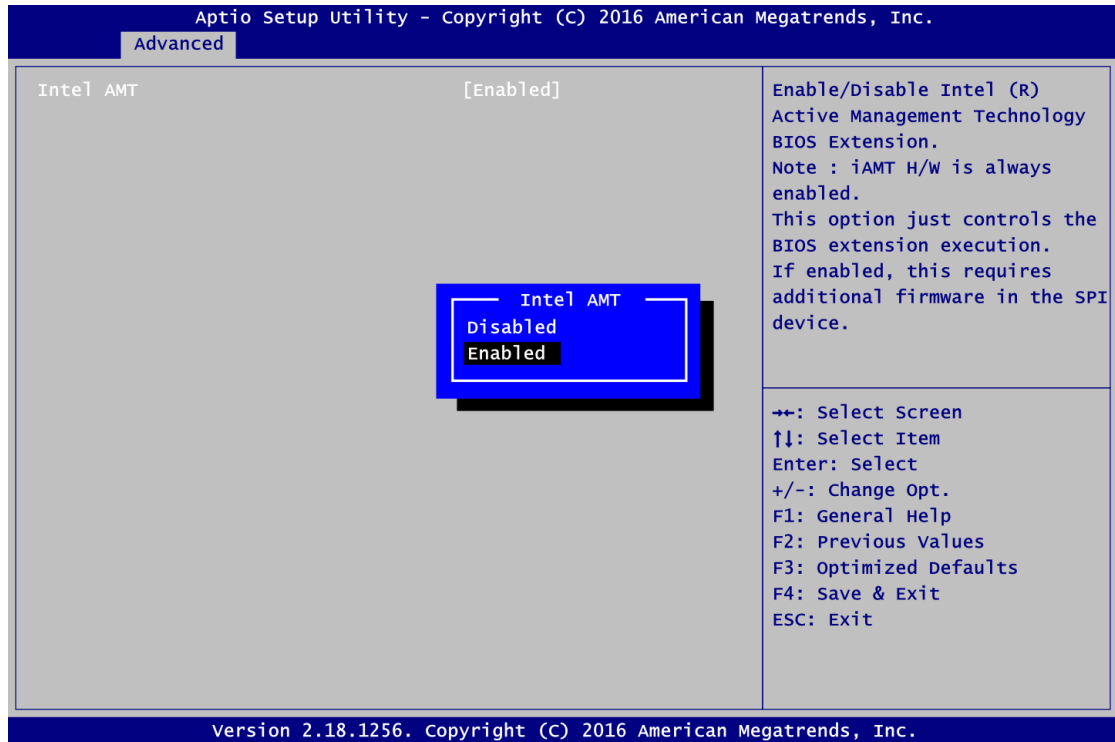

Intel AMT

Enable or disable Intel® Active Management Technology BIOS Extension.

The default is enabled.

USB Configurations

Aptio Setup Utility - Copyright (C) 2016 American Megatrends, Inc.

Advanced

USB Configuration	
USB Module Version	14
USB Controllers:	
1 XHCI	
USB Devices:	
1 Keyboard, 1 Mouse	

→+: Select Screen
↑↓: Select Item
Enter: Select
+/-: Change Opt.
F1: General Help
F2: Previous Values
F3: Optimized Defaults
F4: Save & Exit
ESC: Exit

Version 2.18.1256. Copyright (C) 2016 American Megatrends, Inc.

USB Devices

Display all detected USB devices.

NCT6102D Super IO Configurations

Use this screen to select options for the NCT6102D Super IO Configurations, and change the value of the selected option. A description of the selected item appears on the right side of the screen. For items marked with “>”, please press <Enter> for more options

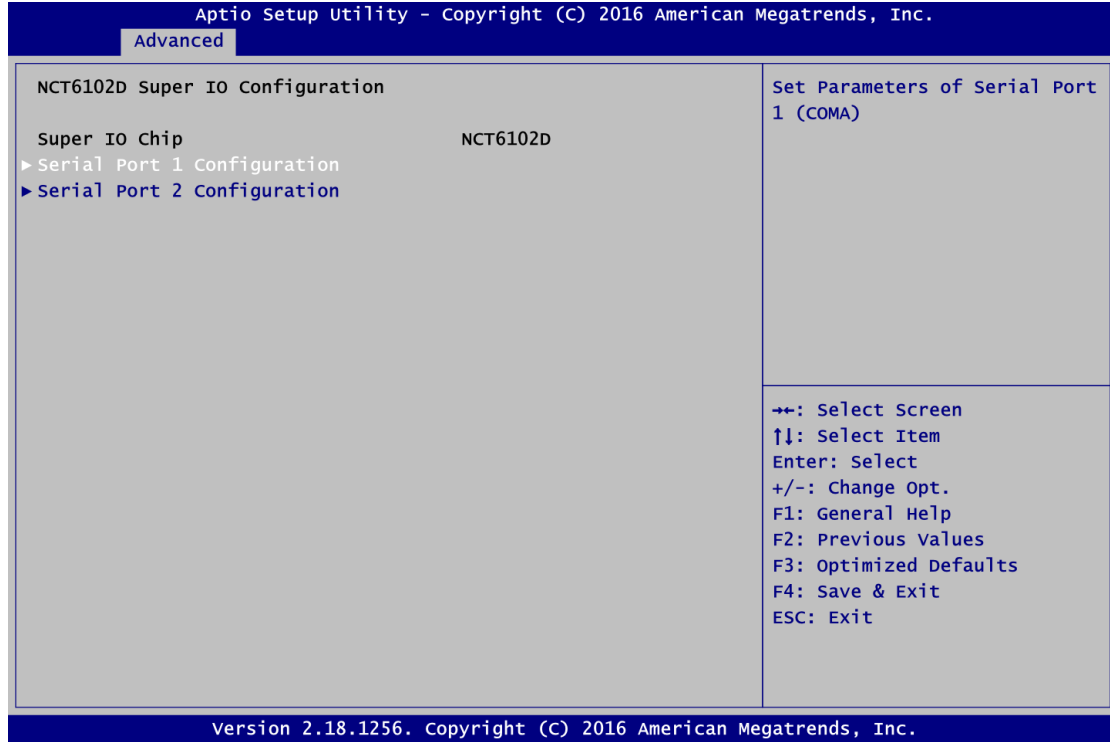

Serial Port 1~2 (COM1~2) Configurations

Use these items to set parameters related to serial ports 1~2.

Serial Port 1

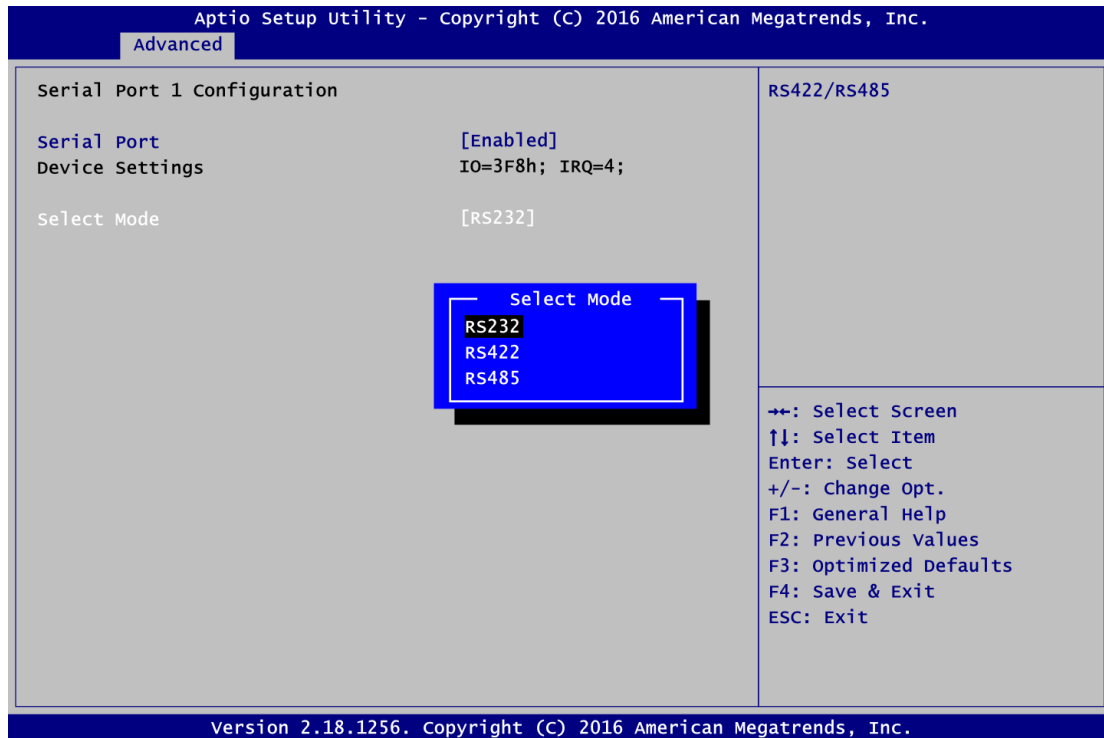

Select Mode

Use this option to set RS-232/RS-422/RS-485 mode.

Serial Port 2

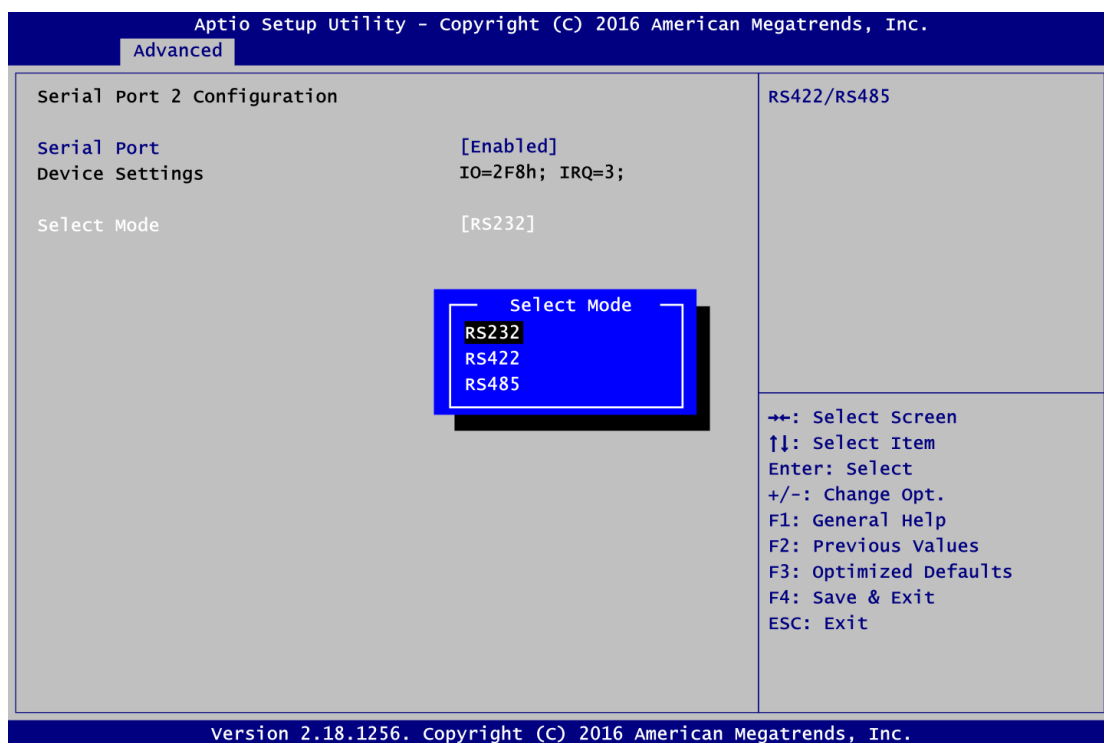

NCT6102DSEC Super IO Configurations

Use this screen to select options for the NCT6106DSEC super IO Configurations, and change the value of the selected option. A description of the selected item appears on the right side of the screen. For items marked with “ ”, please press <Enter> for more options

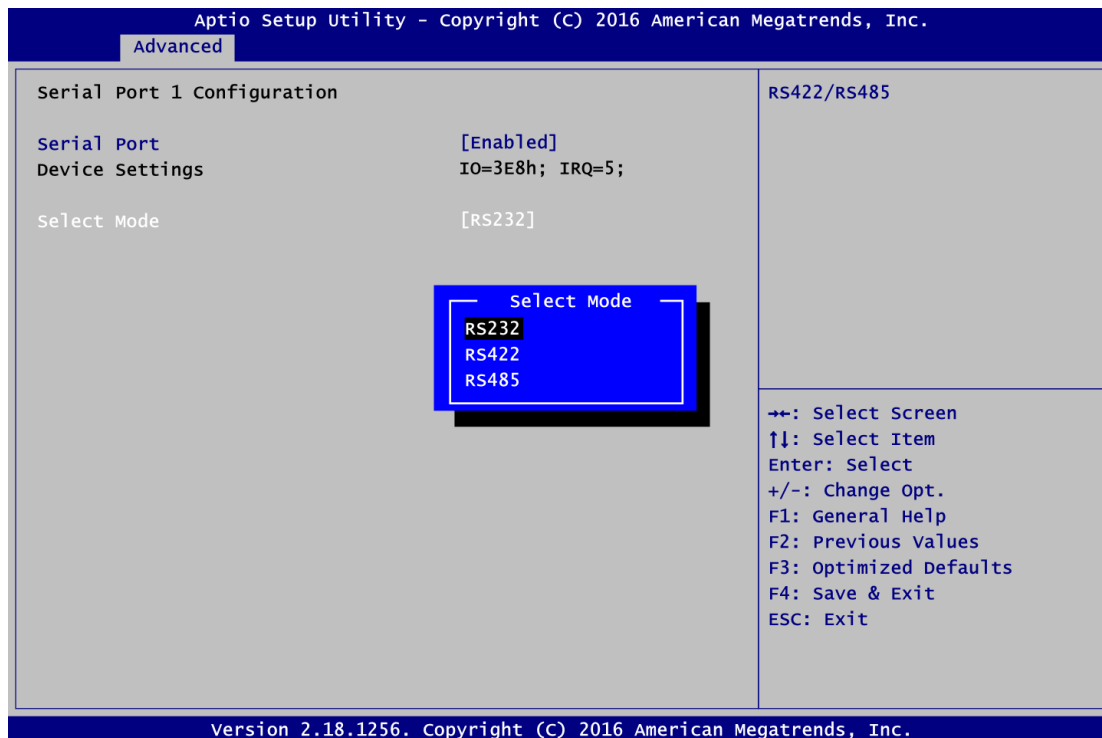

Aptio Setup Utility - Copyright (C) 2016 American Megatrends, Inc.

Advanced

Serial Port 2 Configuration

Serial Port [Enabled]
Device Settings IO=2F8h; IRQ=3;
Select Mode [RS232]

Select Mode

- RS232
- RS422
- RS485

RS422/RS485

←→: Select Screen
↑↓: Select Item
Enter: Select
+/-: Change Opt.
F1: General Help
F2: Previous Values
F3: Optimized Defaults
F4: Save & Exit
ESC: Exit

Version 2.18.1256. Copyright (C) 2016 American Megatrends, Inc.

Hardware Monitor

This screen monitors hardware health status.

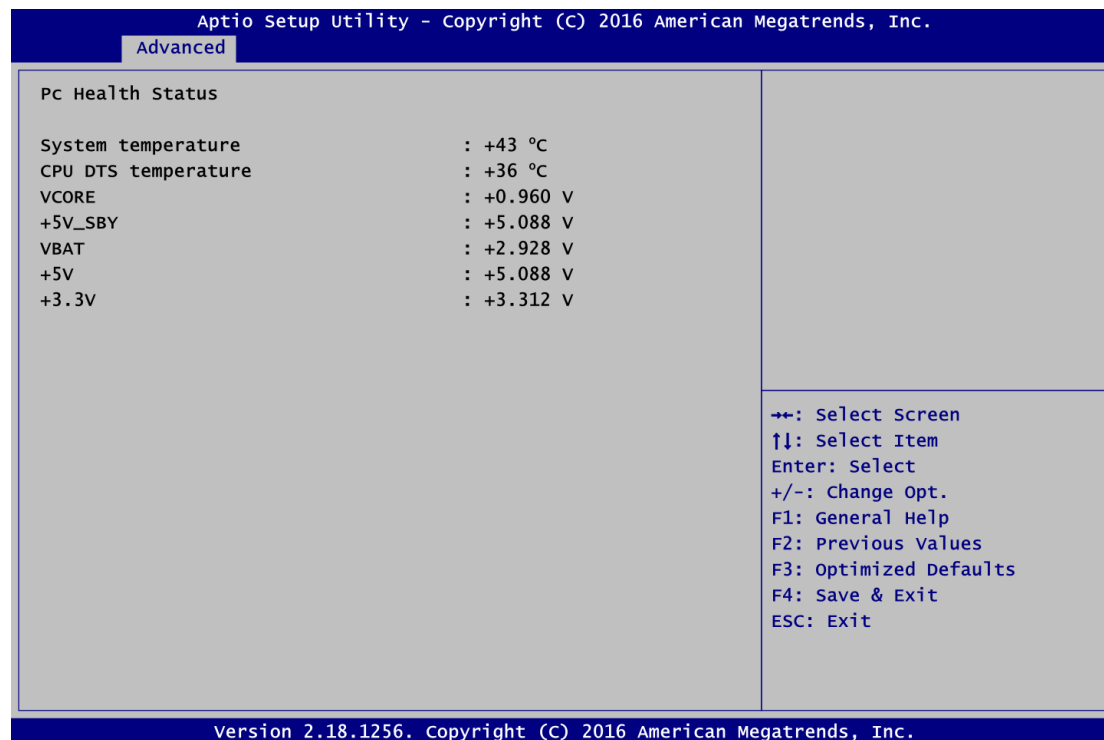

This screen displays the temperature of system and CPU, system voltages (VCORE, +3.3V, +12V and +5V).

Utility Configurations

This screen is for BIOS flash utility.

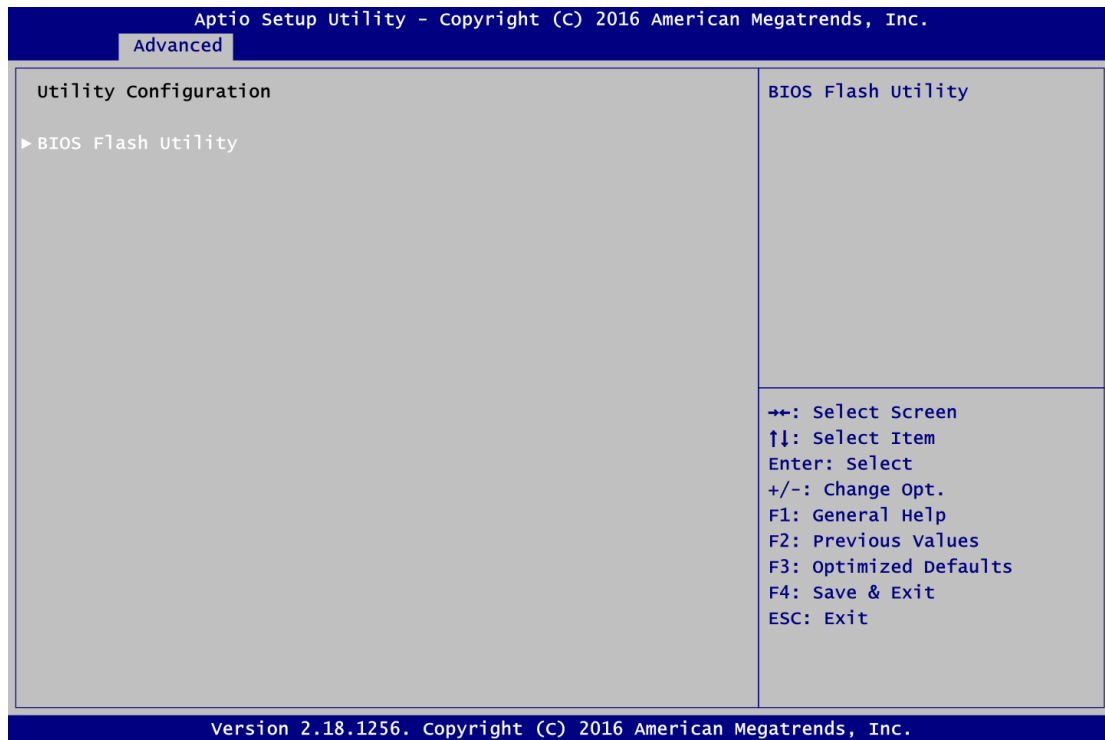

BIOS Flash Utility

BIOS flash utility configuration.

USB Configurations

This screen specifies USB settings.

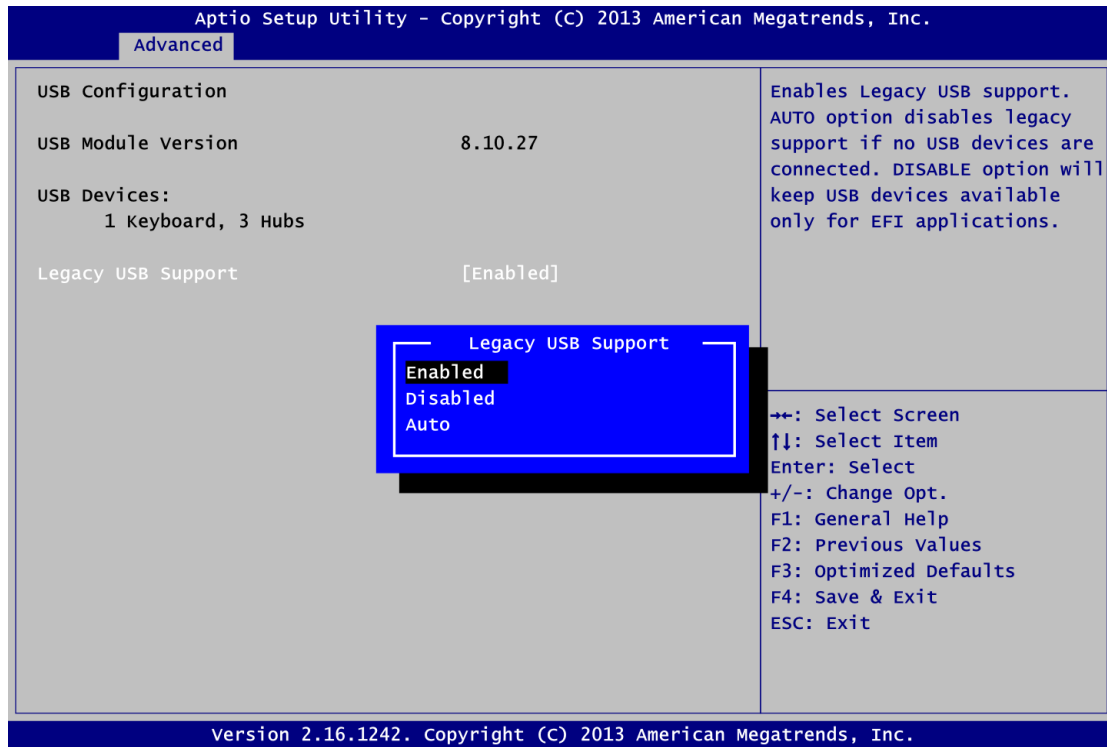

USB Devices

Display all detected USB devices.

Legacy USB Support

Use this item to enable or disable support for USB device on legacy operating system. The default setting is Enabled. Auto option disables legacy support if no USB devices are connected, Disable option will keep USB devices available only for EFI applications.

4.5 Chipset Menu

The Chipset menu allows users to change the advanced chipset settings. Users can select any of the items in the left frame of the screen to go to the sub menus:

- ▶ System Agent (SA) Configurations
- ▶ PCH-IO Configurations

For items marked with “▶”, please press <Enter> for more options.

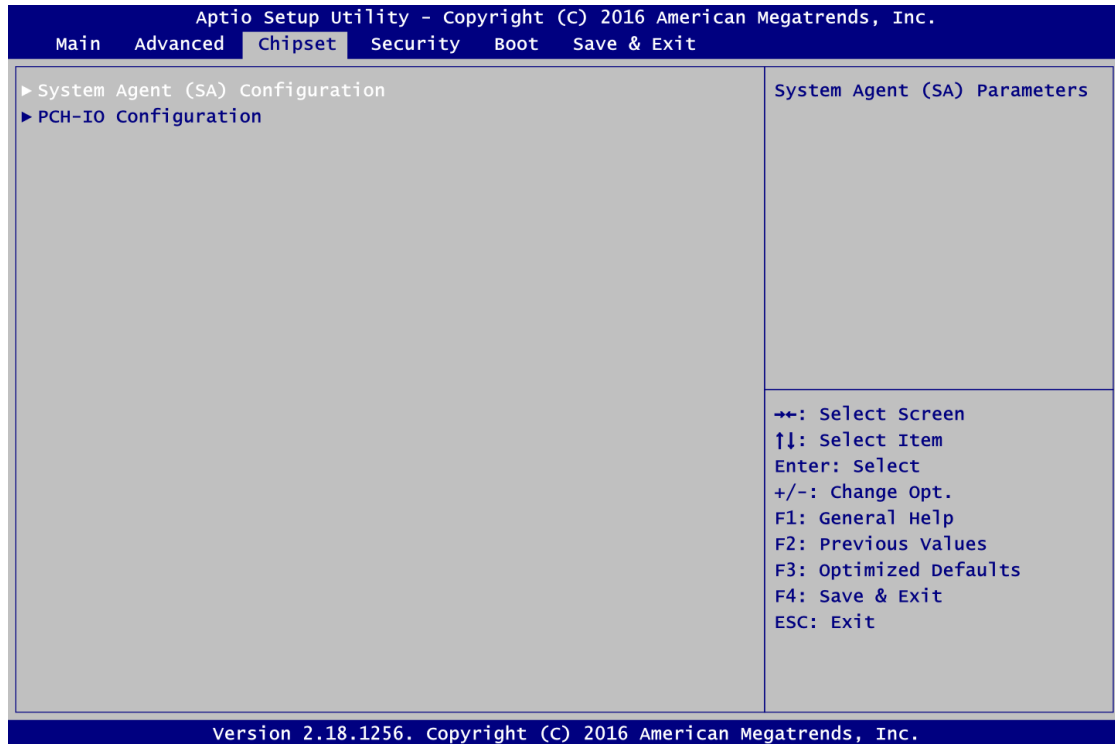

System Agent (SA) Configurations

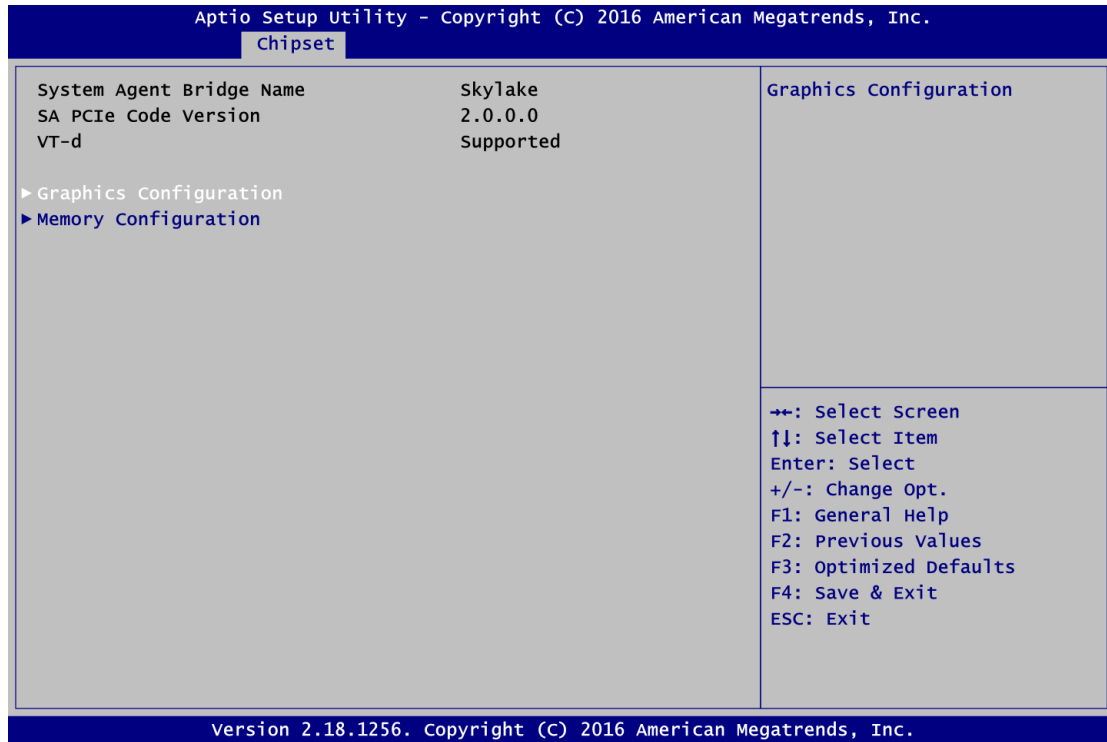

Graphics Configuration

Use this item to configure internal graphics controller.

Memory Configuration

Use this item to refer to the information related to system memory.

Graphic Configurations

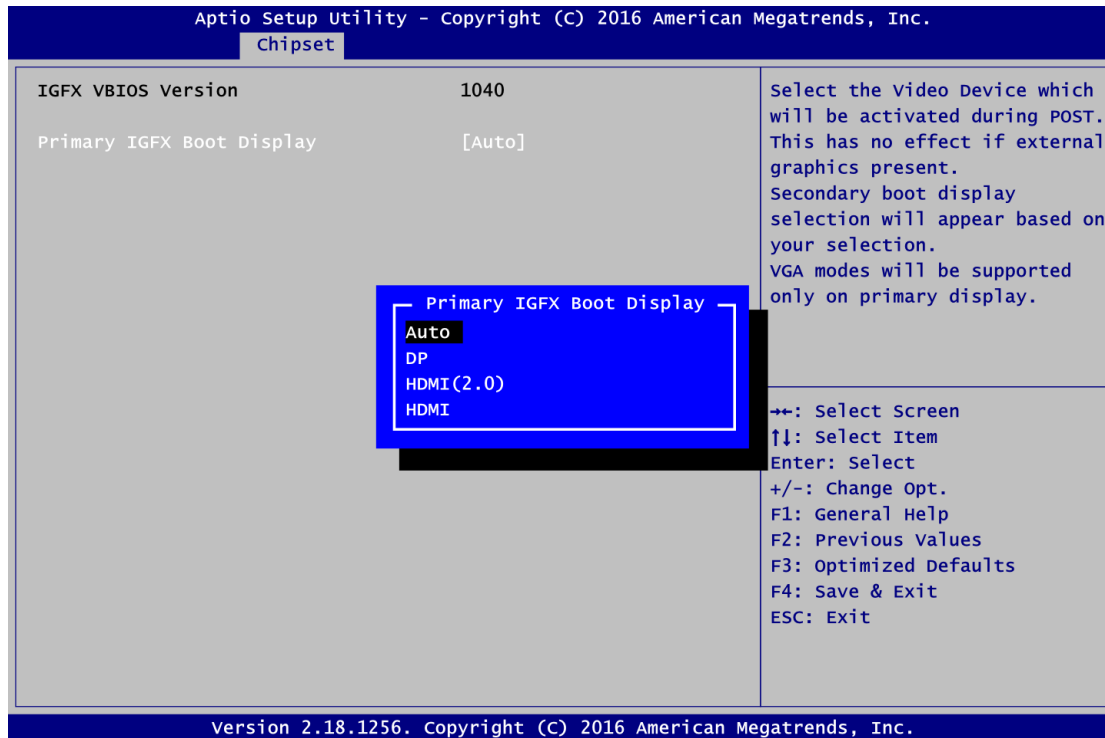

Primary IGFX Boot Display

Select the video device which will be activated during POST (Power-On Self-Test). The default is HDMI (ONBOARD). The image above shows option list in Primary IGFX Boot Display when no I/O board is installed.

Memory Configurations

This screen shows the system memory information.

The screenshot shows the 'Chipset' screen in the Aptio Setup Utility. The title bar reads 'Aptio Setup Utility - Copyright (C) 2016 American Megatrends, Inc.' and the sub-header is 'Chipset'. The main area displays the following memory information:

Memory RC Version	2.0.0.1
Total Memory	8192 MB
DIMM#1	Not Present
DIMM#2	8192 MB

Navigation instructions are listed in the bottom right corner:

- ←→: Select Screen
- ↑↓: Select Item
- Enter: Select
- +/-: Change Opt.
- F1: General Help
- F2: Previous Values
- F3: Optimized Defaults
- F4: Save & Exit
- ESC: Exit

The footer of the screen reads 'Version 2.18.1256. Copyright (C) 2016 American Megatrends, Inc.'

PCH-IO Configurations

This screen allows users to set PCH parameters.

The screenshot shows the 'Chipset' screen in the Aptio Setup Utility. The title bar reads 'Aptio Setup Utility - Copyright (C) 2016 American Megatrends, Inc.' and the sub-header is 'Chipset'. The main area displays the following PCH parameters:

Intel PCH RC Version	2.0.0.0	Enable or disable onboard NIC.
Intel PCH SKU Name	PCH-H Desktop Q170 SKU	
Intel PCH Rev ID	31/D1	
PCH LAN Controller	[Enabled]	
Wake on LAN	[Enabled]	

Navigation instructions are listed in the bottom right corner:

- ←→: Select Screen
- ↑↓: Select Item
- Enter: Select
- +/-: Change Opt.
- F1: General Help
- F2: Previous Values
- F3: Optimized Defaults
- F4: Save & Exit
- ESC: Exit

The footer of the screen reads 'Version 2.18.1256. Copyright (C) 2016 American Megatrends, Inc.'

Security Menu

Aptio Setup Utility - Copyright (C) 2013 American Megatrends, Inc.

Main Advanced Chipset **Security** Boot Save & Exit

<p>Password Description</p> <p>If ONLY the Administrator's password is set, then this only limits access to Setup and is only asked for when entering Setup.</p> <p>If ONLY the User's password is set, then this is a power on password and must be entered to boot or enter Setup. In Setup the User will have Administrator rights.</p> <p>The password length must be in the following range:</p> <p>Minimum length 3</p> <p>Maximum length 20</p> <p>Administrator Password</p> <p>User Password</p>	<p>Set Administrator Password</p> <hr/> <p>←→: Select Screen ↑↓: Select Item Enter: Select +/-: Change Opt. F1: General Help F2: Previous Values F3: Optimized Defaults F4: Save & Exit ESC: Exit</p>
-------------------------------------------------------------------------------------------------------------------------------------------------------------------------------------------------------------------------------------------------------------------------------------------------------------------------------------------------------------------------------------------------------------------------------------------------------------------------------------------------------------------------------------------------	---------------------------------------------------------------------------------------------------------------------------------------------------------------------------------------------------------------------------------------------------

Version 2.16.1242. Copyright (C) 2013 American Megatrends, Inc.

Administrator Password

This item indicates whether an administrator password has been set (installed or uninstalled).

User Password

This item indicates whether a user password has been set (installed or uninstalled).

4.6 Boot Menu

The Boot menu allows users to change boot options of the system.

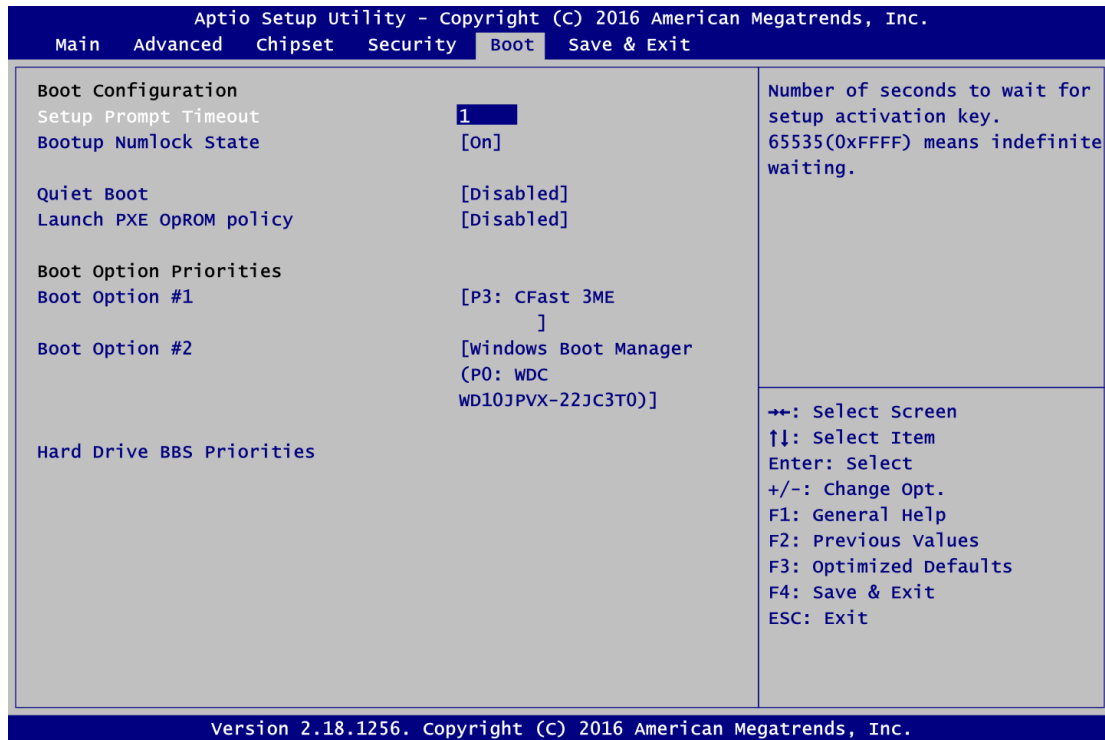

Setup Prompt Timeout

Use this item to set up number of seconds to wait for setup activation key where 65535(0xFFFF) means indefinite waiting.

Bootup NumLock State

Use this item to select the power-on state for the keyboard NumLock.

Quiet Boot

Select to display either POST output messages or a splash screen during boot-up.

Legacy PXE OpROM

Use this item to enable or disable the boot ROM function of the onboard LAN chip when the system boots up.

Vedio

Control the execution of UEFI and legacy video OpROM

Boot Option Priorities

These are settings for boot priority. Specify the boot device priority sequence from the available devices.

4.7 Save & Exit Menu

The Save & Exit menu allows users to load system configurations with optimal or fail-safe default values.

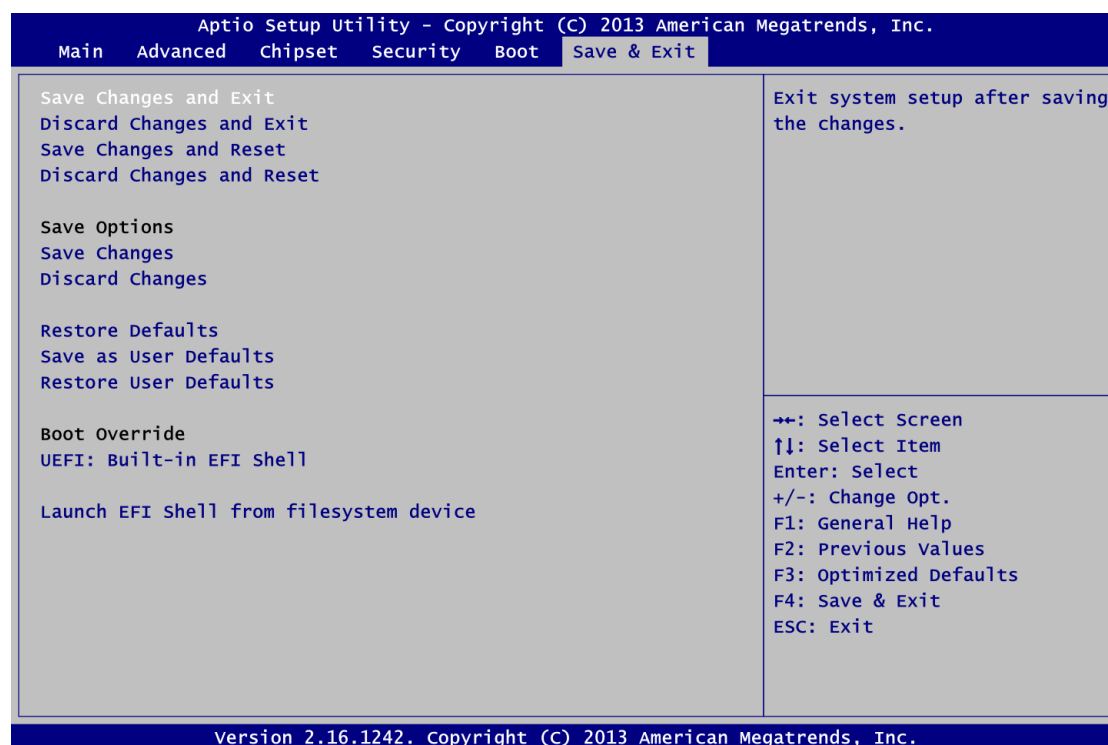

Save Changes and Exit

When users have completed the system configuration changes, select this option to leave Setup and return to Main Menu. Select Save Changes and Exit from the Save & Exit menu and press <Enter>. Select Yes to save changes and exit.

Discard Changes and Exit

Select this option to quit Setup without making any permanent changes to the system configurations and return to Main Menu. Select Discard Changes and Exit from the Save & Exit menu and press <Enter>. Select Yes to discard changes and exit.

Save Changes and Reset

When completed the system configuration changes, select this option to leave Setup and reboot the computer so the new system configurations take effect. Select Save Changes and Reset from the Save & Exit menu and press <Enter>. Select Yes to save changes and reset.

Discard Changes and Reset

Select this option to quit Setup without making any permanent changes to the system configuration and reboot the computer. Select Discard Changes and Reset from the Save & Exit menu and press <Enter>. Select Yes to discard changes and reset.

Save Changes

When completed the system configuration changes, select this option to save changes. Select Save Changes from the Save & Exit menu and press <Enter>. Select Yes to save changes.

Discard Changes

Select this option to quit Setup without making any permanent changes to the system configurations. Select Discard Changes from the Save & Exit menu and press <Enter>. Select Yes to discard changes.

Restore Defaults

It automatically sets all Setup options to a complete set of default settings when users select this option. Select Restore Defaults from the Save & Exit menu and press <Enter>.

Save as User Defaults

Select this option to save system configuration changes done so far as User Defaults. Select Save as User Defaults from the Save & Exit menu and press <Enter>.

Restore User Defaults

It automatically sets all Setup options to a complete set of User Defaults when users select this option. Select Restore User Defaults from the Save & Exit menu and press <Enter>.

Boot Override

Select a drive to immediately boot that device regardless of the current boot order.

APPENDIX A WATCHDOG TIMER

About Watchdog Timer

Software stability is major issue in most applications. Some embedded systems are not watched by human for 24 hours. It is usually too slow to wait for someone to reboot when computer hangs. The systems need to be able to reset automatically when things go wrong. The watchdog timer gives us solutions in this regard.

The watchdog timer is a counter that triggers a system to reset when it counts down to zero from a preset value. The software starts the counter with an initial value and must reset it periodically. If the counter ever reaches zero, it means the software has crashed, the system will reboot.

Sample Program

The following example enables configurations using debug tool.

Enable WDT

↓

Enable configuration:

2E 87; Un-lock super I/O

2E 87

↓

Select logic device:

2E 07

2F 08

↓

WDT device enable:

2E 30

2F 01

↓

Set timer unit:

2E F0

2F 00 ; (00: Sec; 08:Minute)

↓

Set base timer:

2E F1

2F 0A; Set reset time (where 0A (hex) = 10sec)

Disable WDT

↓

Enable configuration:

2E 87; Un-lock super I/O

2E 87

↓

Select logic device:

2E 07

2F 08

↓

WDT device disable:





2E 30

2F 00

APPENDIX B PROGRAMMABLE LED

About Programmable

LED eBOX670-891-FL supports four programmable LED which allows user to program the LED status. It can do as special indicator or alarm. Please refer to Driver CD for sample code and demo tool.





-  Demo
-  LIB
-  SRC
-  Readme

This page is intentionally left blank.

APPENDIX C PROGRAMMABLE DIGITAL I/O

About Programmable Digital I/O

LED eBOX670-891-FL supports 32 channels programmable digital I/O which allows user to program the DI or DO. Please refer to Driver CD for sample code and demo tool.

-  Demo
-  LIB
-  SRC
-  Readme

This page is intentionally left blank.

APPENDIX D CONFIGURING SATA FOR RAID

D.1 Configuring SATA Hard Drive(s) for RAID (Controller: Intel[®] Q170)

Before you begin the SATA configuration, please prepare:

- Two SATA hard drives (to ensure optimal performance, it is recommended that you use two hard drives with identical model and capacity). If you do not want to create RAID with the SATA controller, you may prepare only one hard drive.

Please follow up the steps below to configure SATA hard drive(s):

1. Install SATA hard drive(s) in your system.
2. Enter the BIOS Setup to configure SATA controller mode and boot sequence.
3. Configure RAID by the RAID BIOS.

1. Installing SATA hard drive(s) in your system.

Connect one end of the SATA signal cable to the rear of the SATA hard drive, and the other end to available SATA port(s) on the board. Then, connect the power connector of power supply to the hard drive.

2. Configuring SATA controller mode and boot sequence by the BIOS Setup.

You have to make sure whether the SATA controller is configured correctly by system BIOS Setup and set up BIOS boot sequence for the SATA hard drive(s).

- 2.1. Turn on your system, and then press the button to enter BIOS Setup during running POST (Power-On Self-Test). If you want to create RAID, just go to the Advanced Settings menu\SATA Configuration, select the "SATA Mode Selection", and press <Enter> for more options.

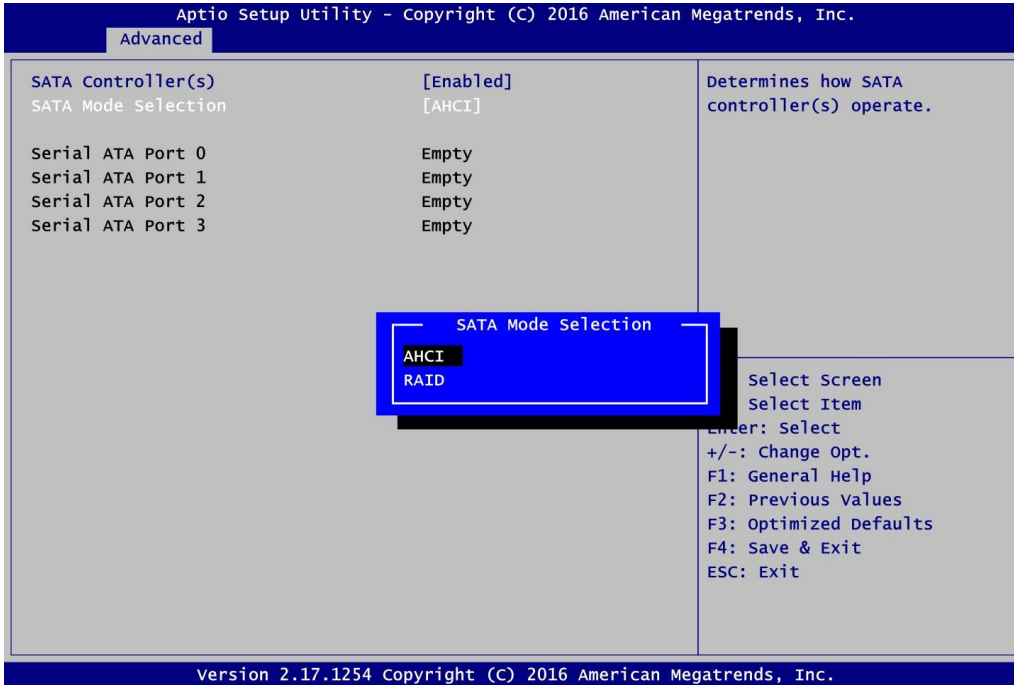

A list of options appears, please select "RAID".

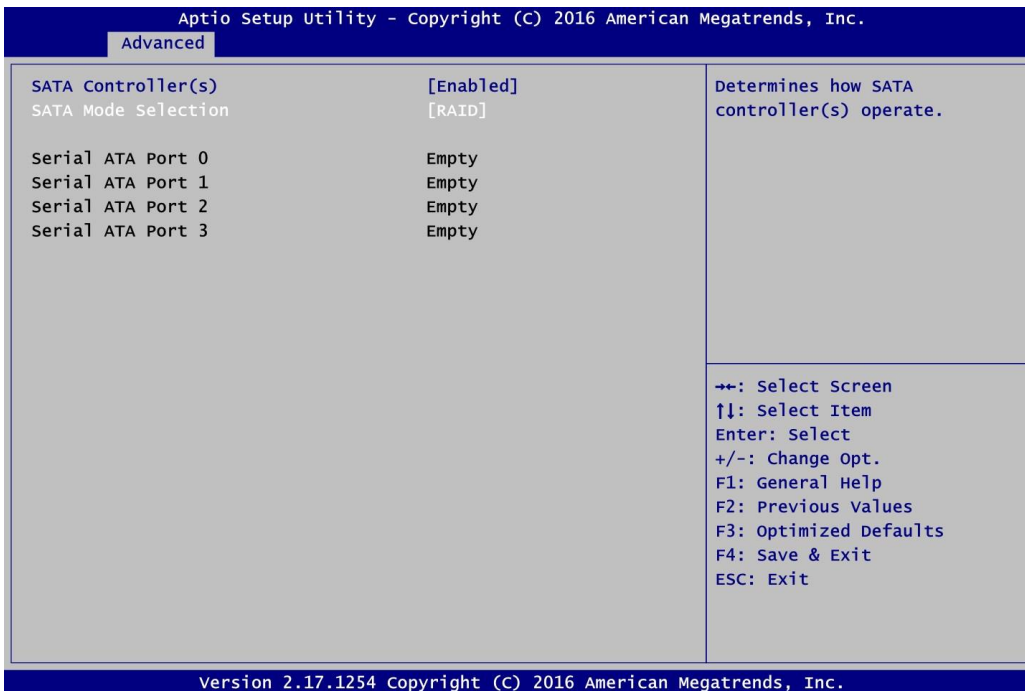

- 2.2. Save and exit the BIOS Setup.

3. Configuring RAID by the RAID BIOS.

Enter the RAID BIOS setup utility to configure a RAID array. Skip this step and proceed if you do not want to create a RAID.

- 3.1. After the POST memory testing and before the operating system booting, a message "Press <Ctrl-I> to enter Configuration Utility" shows up, accordingly, press <Ctrl + I> to enter the RAID BIOS setup utility.

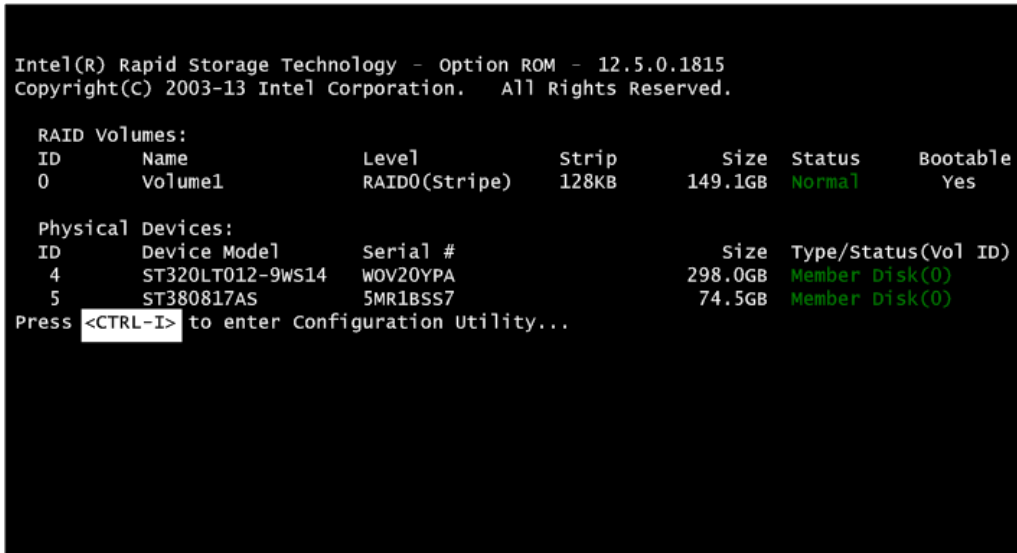

- 3.2. After you press <Ctrl + I>, the Create RAID Volume screen will appear. If you want to create a RAID array, select the Create RAID Volume option in the Main Menu and press <Enter>.

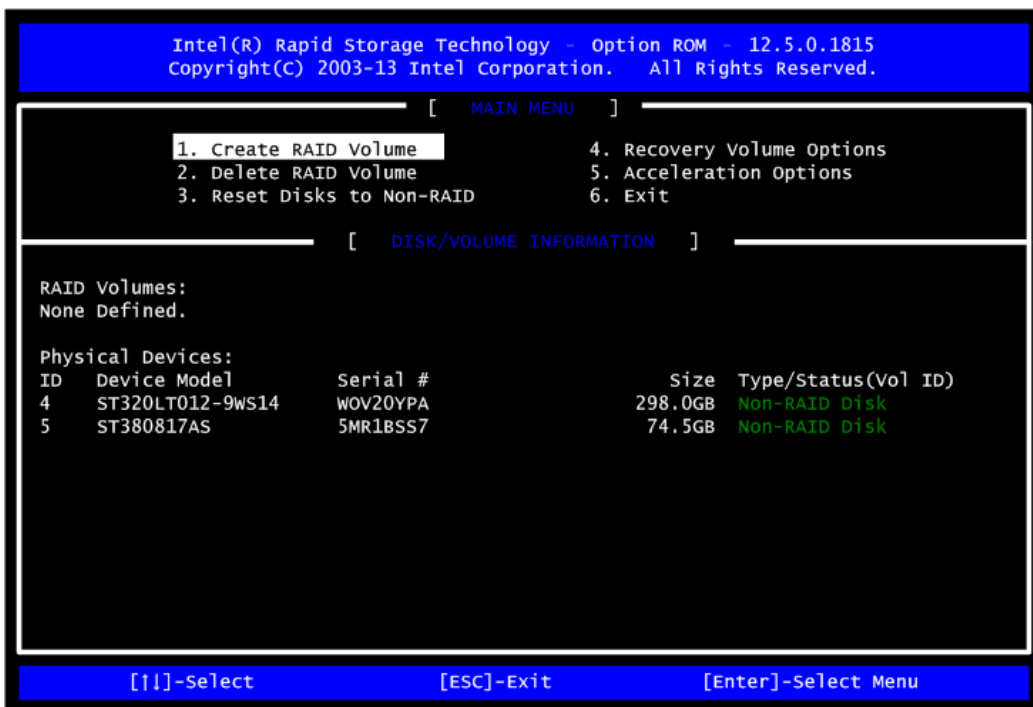

- 3.3. After entering the Create Volume Menu screen, you can type the disk array name with 1~16 letters (letters cannot be special characters) in the item "Name".

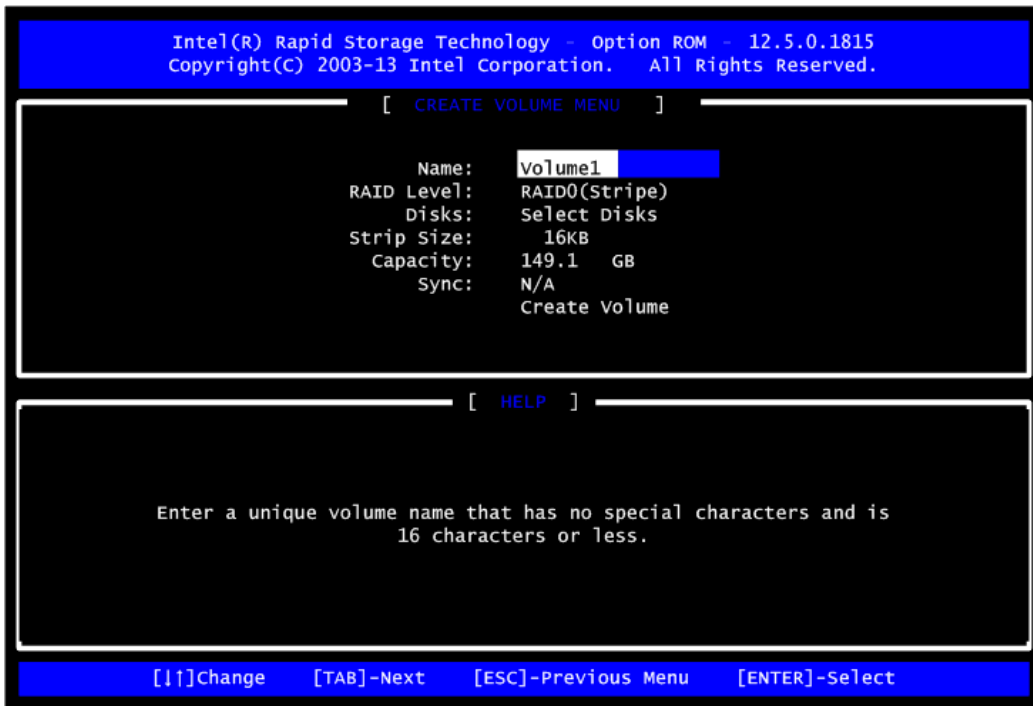

- 3.4. When finished, press <Enter> to select a RAID level. There are three RAID levels: RAID0, RAID1 and RAID5 and RAID10. Select a RAID level and press <Enter>.

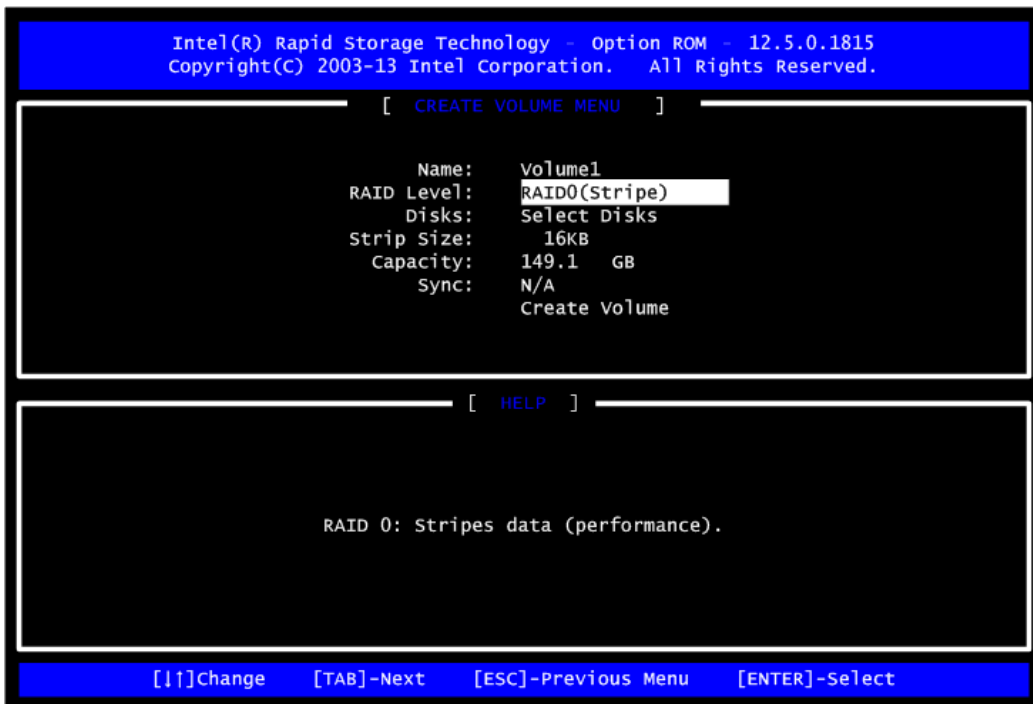

- 3.5. Set the stripe block size. The KB is the standard unit of stripe block size. The stripe block size can be 4KB to 128KB. After the setting, press <Enter> for the array capacity.

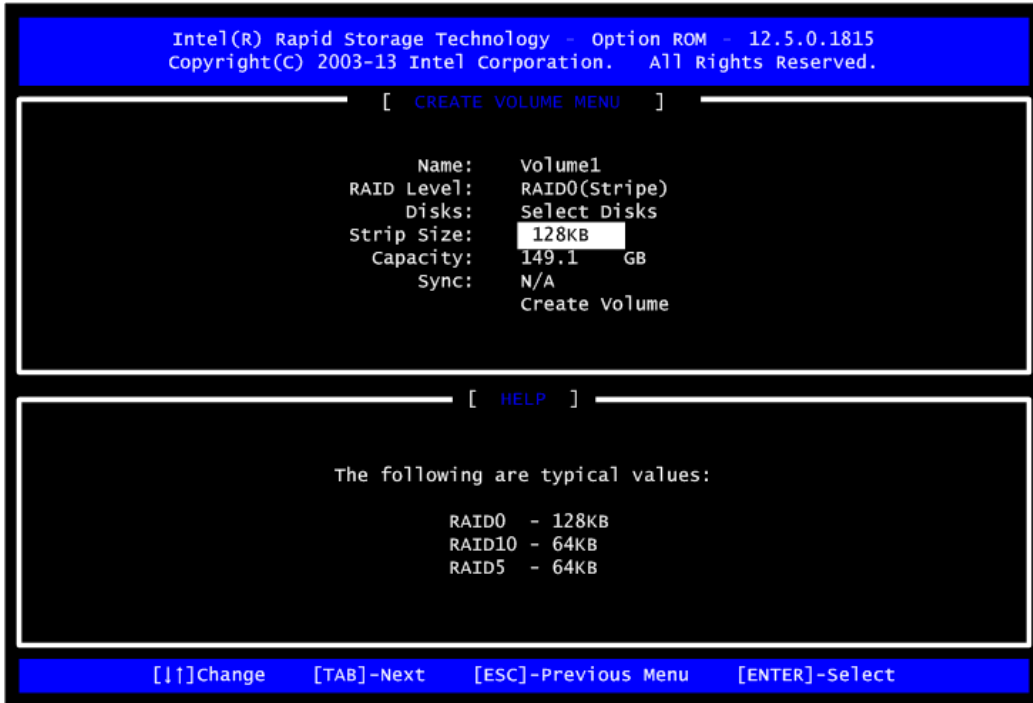

- 3.6. After setting all the items on the menu, select Create Volume and press <Enter> to start creating the RAID array.

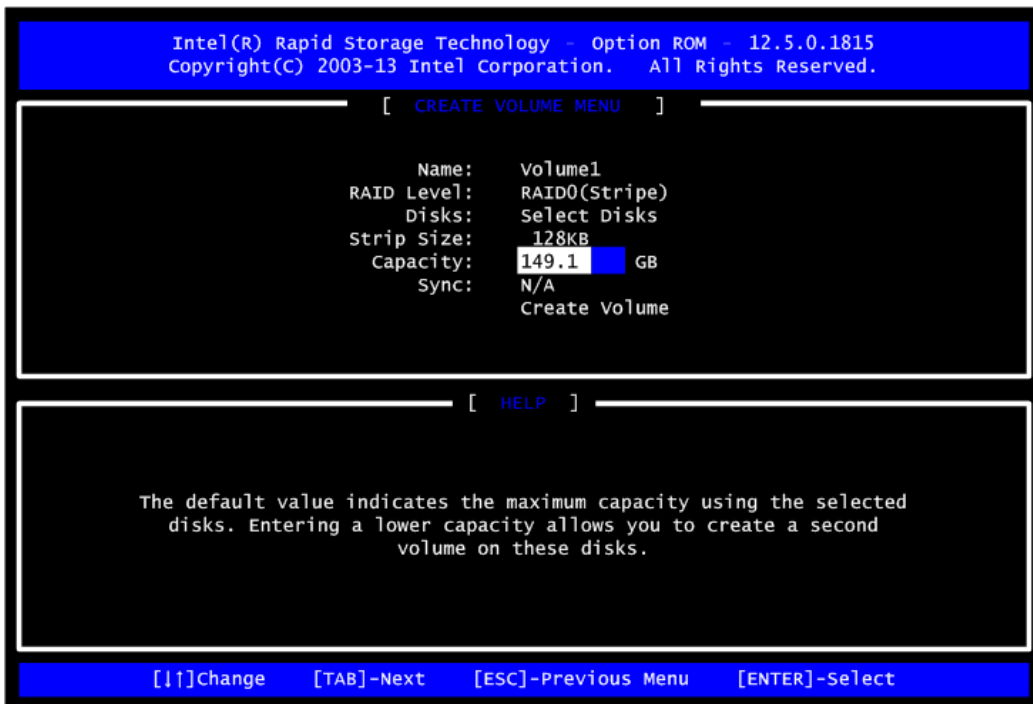

3.7. When prompting the confirmation, press <Y> to create this volume, or <N> to cancel the creation.

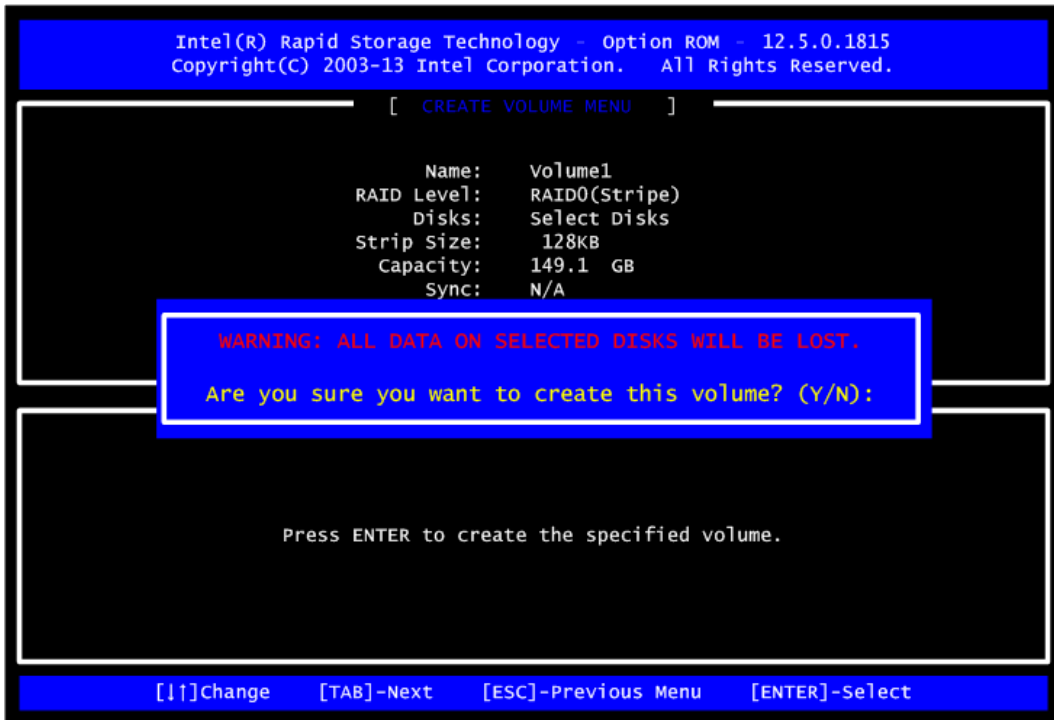

After the creation is completed, you can see detailed information about the RAID Array in the Disk/Volume Information section, including RAID mode, disk block size, disk name, and disk capacity, etc.

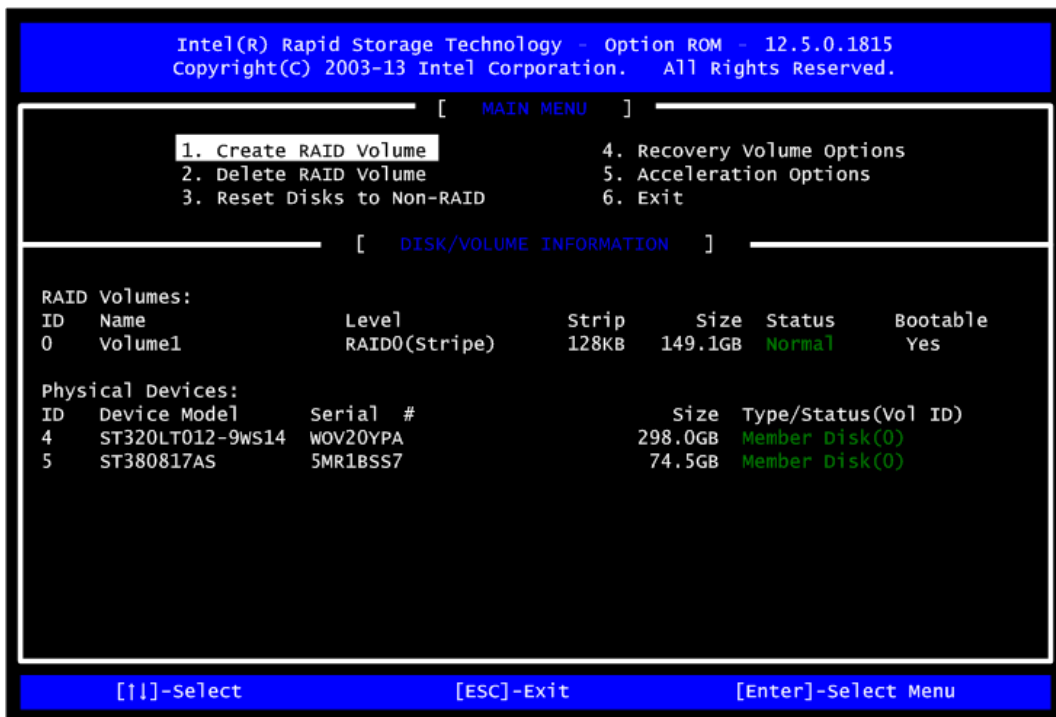

Delete RAID volume

If you want to delete a RAID volume, select the Delete RAID Volume option in Main Menu. Press <Enter> and follow on-screen instructions.

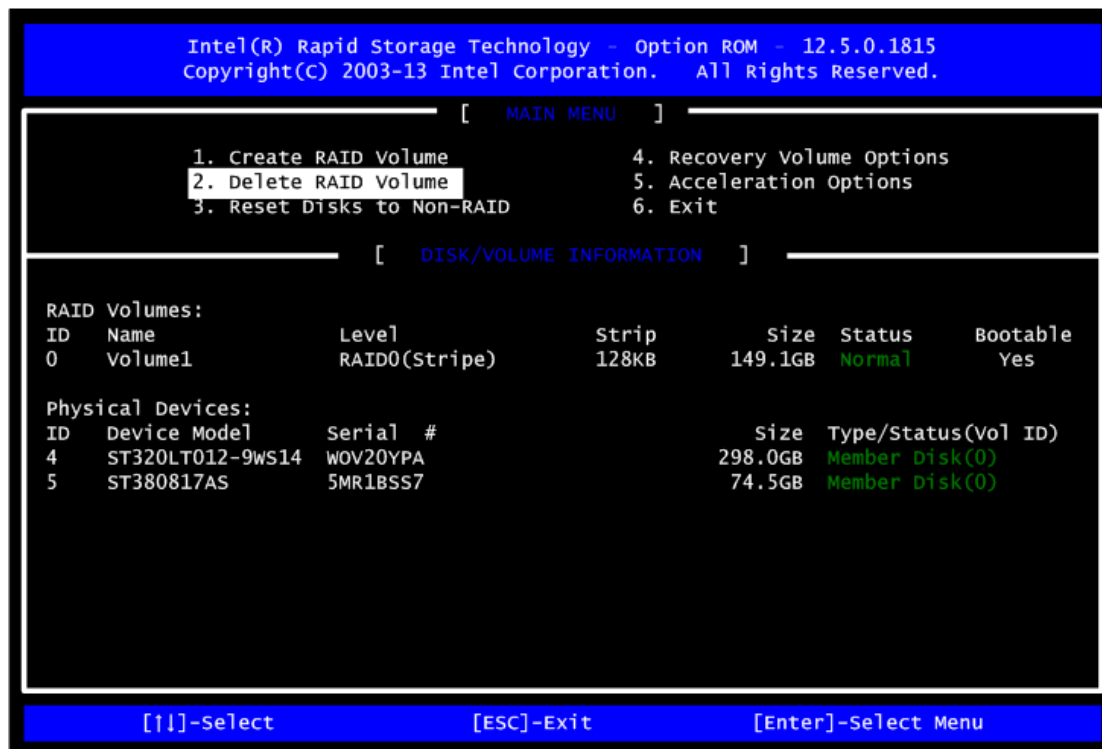

Please press <Esc> to exit the RAID BIOS utility. Now, you can proceed to install a SATA driver controller and the operating system.

This page is intentionally left blank.

APPENDIX E iAMT SETTINGS

The Intel® Active Management Technology (Intel® iAMT) has decreased a major barrier to IT efficiency that uses built-in platform capabilities and popular third-party management and security applications to allow IT a better discovering, healing, and protection their networked computing assets.

In order to utilize Intel® iAMT you must enter the ME BIOS (<Ctrl + P> during system startup), change the ME BIOS password, and then select “Intel® iAMT” as the manageability feature.

E.1 Entering MEBx

1. You must go to BIOS to enable iAMT function.
2. Exit from BIOS after starting iAMT, and press <Ctrl + P> to enter MEBx Setting.

*****It is better to press <Ctrl + P> before the screen popping out.***

E.2 Set and Change Password

1. User will be asked to set a password when first log in. The default password is “admin”.

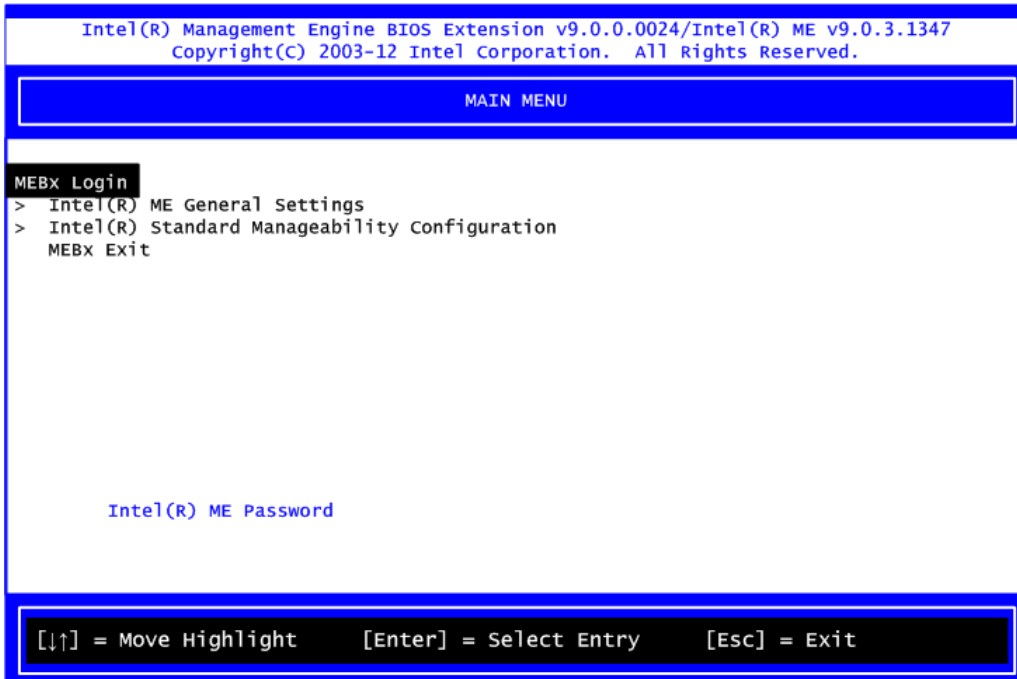

2. User will be asked to change the password before setting ME.

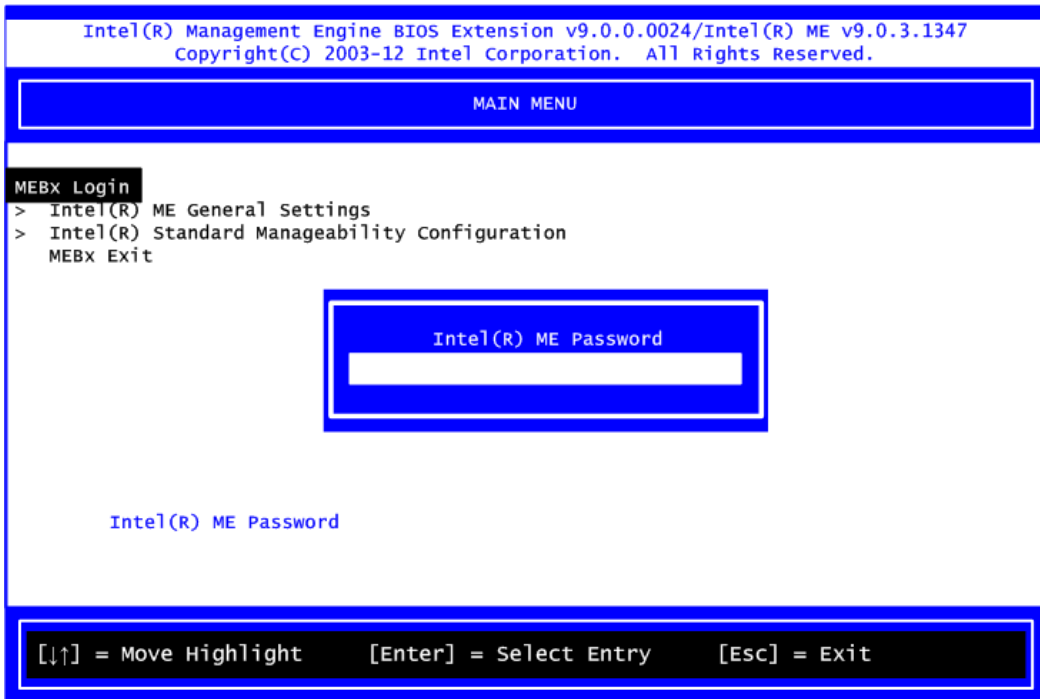

3. User must confirm the new password while revising. The new password must contain:
(example: **!!11qqQQ**) (default value).

- Eight characters
- One upper case
- One lower case
- One number
- One special symbol, such as ! , ` , \$ or ; , ' (, ` , " , excepted)

Underline (_) and space are valid characters for password, but they won't make higher complexity.

E.3 iAMT Settings

Select Intel® iAMT configuration and press <Enter>.

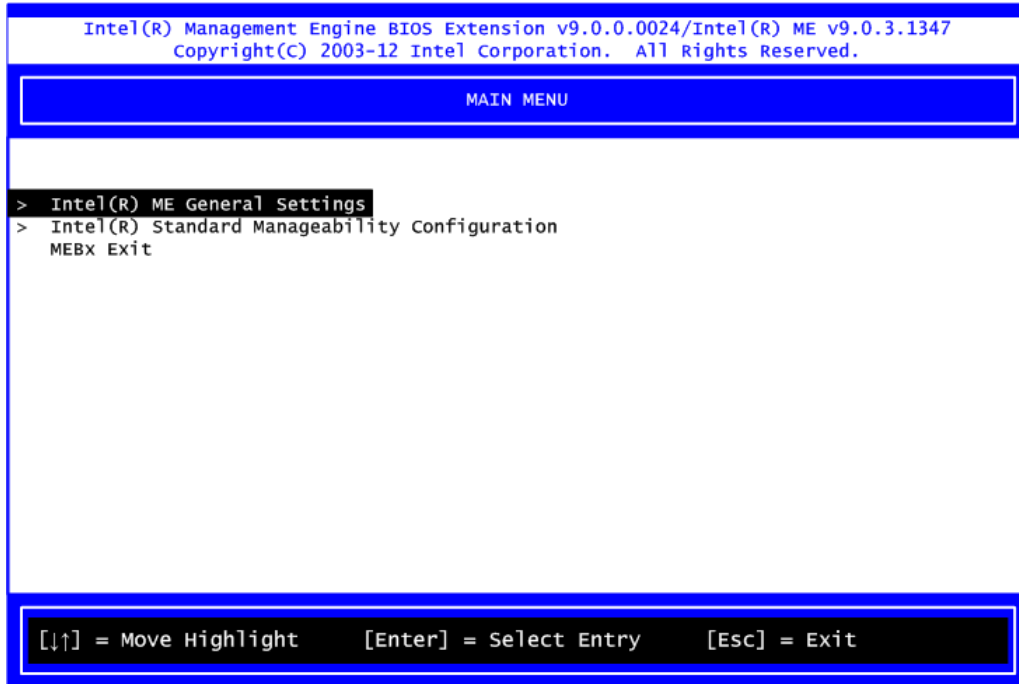

1. Select Network Setup to configure iAMT.

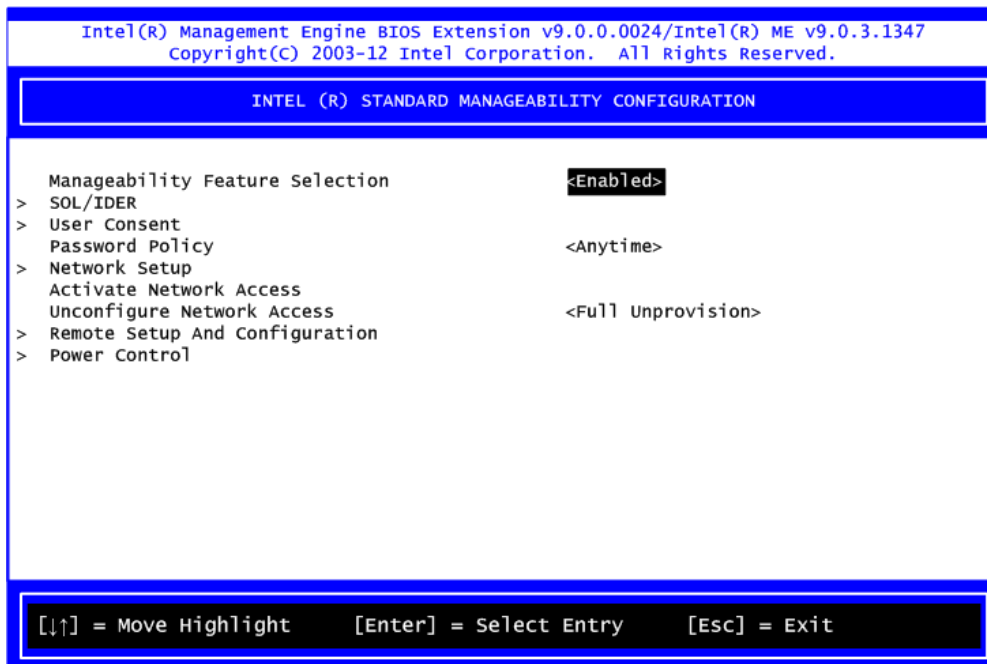

2. Select TCP/IP to get into Network interface and set it to Enabled. Get into DHCP Mode and set it to Disabled.

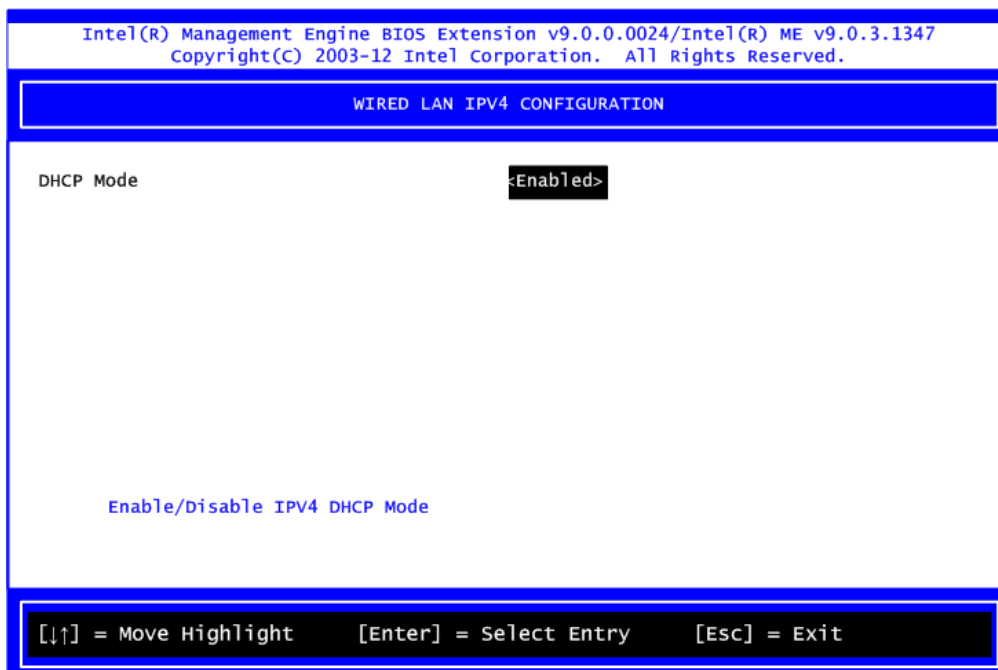
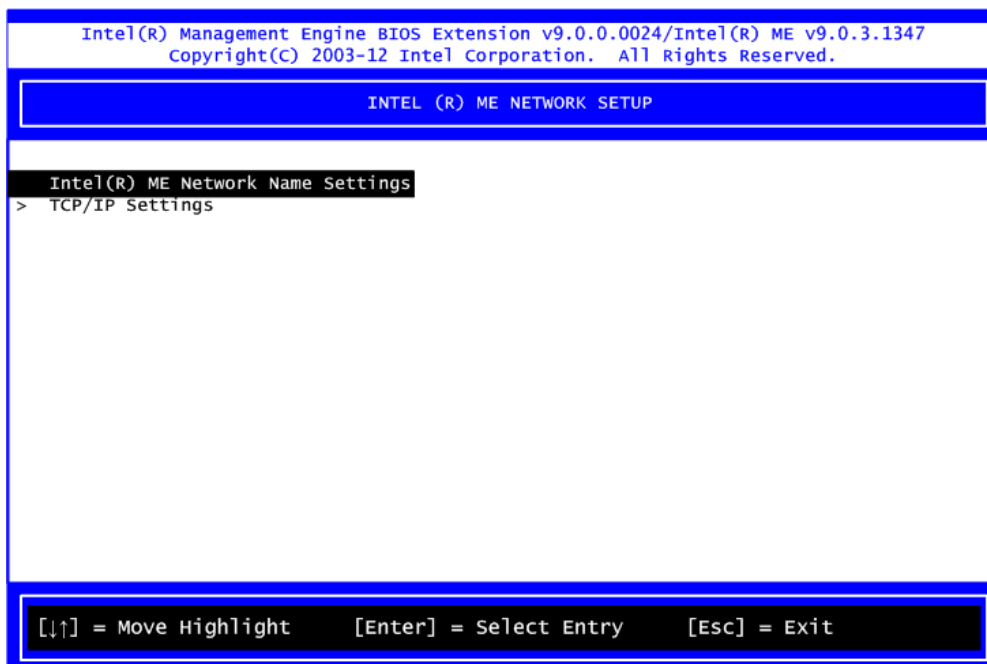

3. If DHCP Mode is disabled, set the following settings:

- IP address
- Subnet mask

Intel(R) Management Engine BIOS Extension v9.0.0.0024/Intel(R) ME v9.0.3.1347
Copyright(C) 2003-12 Intel Corporation. All Rights Reserved.

WIRELESS LAN IPV4 CONFIGURATION

DHCP Mode <Disabled>
 IPV4 Address 10.1.40.214
 Subnet Mask Address 255.255.255.0
 Default Gateway Address 0.0.0.0
 Preferred DNS Address 0.0.0.0
 Alternate DNS Address

Subnet mask (e.g. 255.255.255.0)
255.255.255.0_

<Enter> = Complete Entry [Esc] = Discard Changes

4. Go back to Intel® iAMT Configuration, then select Activate Network Access and press <Enter>.

Intel(R) Management Engine BIOS Extension v9.0.0.0024/Intel(R) ME v9.0.3.1347
Copyright(C) 2003-12 Intel Corporation. All Rights Reserved.

INTEL (R) STANDARD MANAGEABILITY CONFIGURATION

Manageability Feature Selection <Enabled>
 > SOL/IDER
 > User Consent
 Password Policy <Anytime>
 > Network Setup
 Activate Network Access
 Unconfigure Network Access
 > Remote Setup And Configurati
 > Power Control

Activates the current network settings
and opens the ME network interface
Continue: (Y/N)

[↓↑] = Move Highlight [Enter] = Select Entry [Esc] = Exit

5. Exit from MEBx after completing the iAMT settings.

E.4 iAMT Web Console

1. From a web browser, please type [http://\(IP ADDRESS\):16992](http://(IP ADDRESS):16992), which connects to iAMT Web.

Example: <http://10.1.40.214:16992>

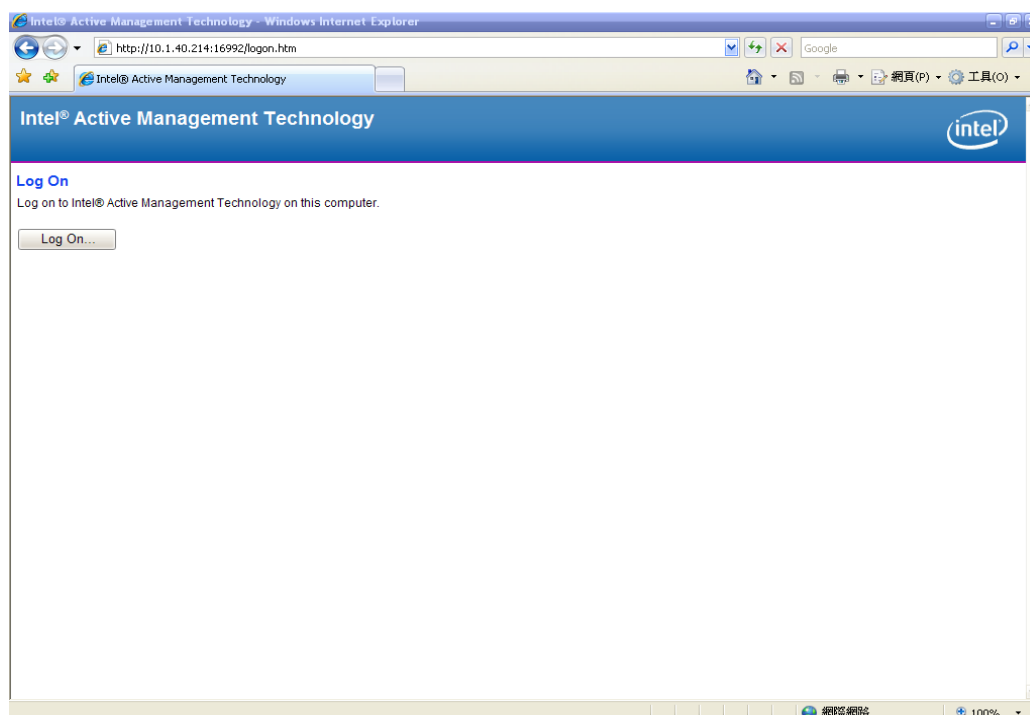

2. To log on, you will be required to type in username and password for access to the Web.

USER: admin (default value)

PASS: (MEBx password)

3. Enter the iAMT Web.

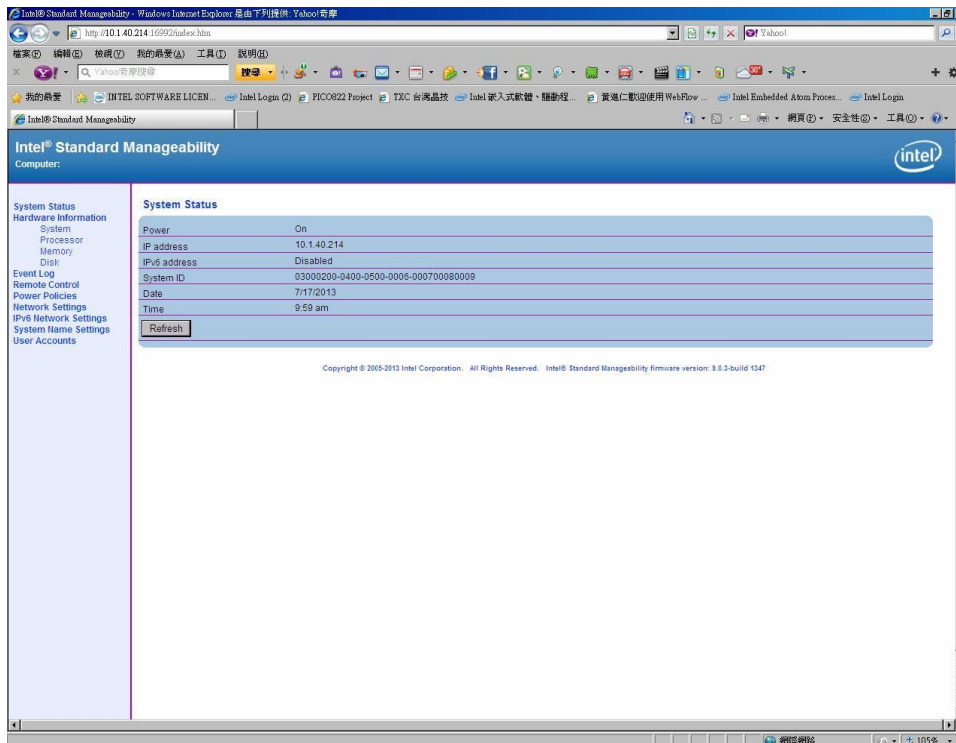

4. Click Remote Control, and select commands on the right side.

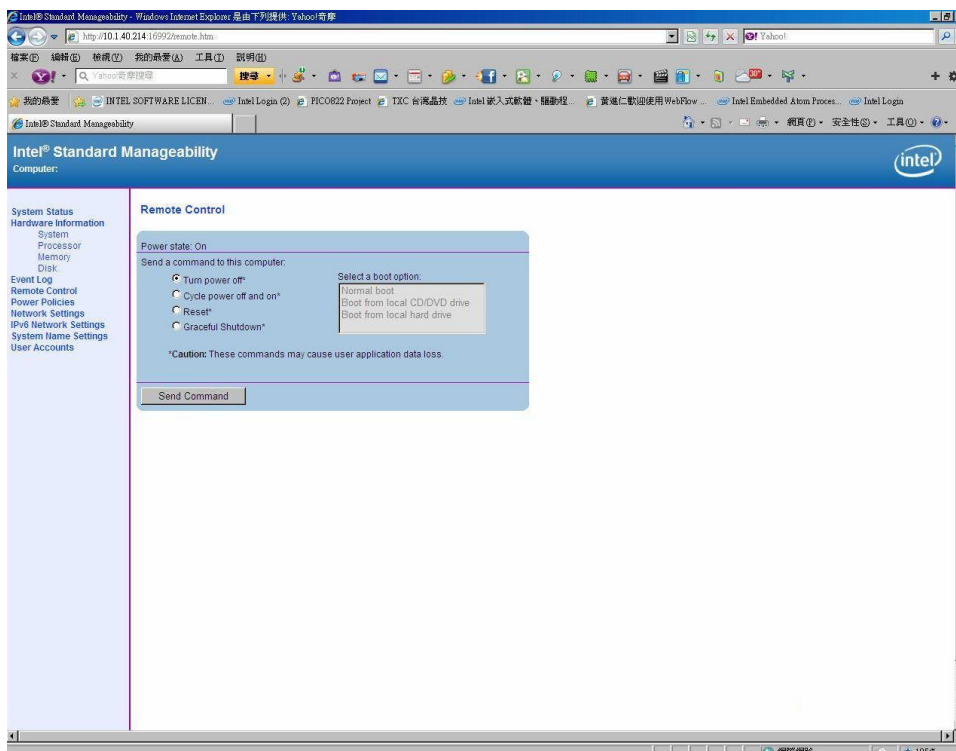

5. When you have finished using the iAMT Web console, close the Web browser.

This page is intentionally left blank.