



®

AXIOMTEK

eBOX560-500-FL Series

Embedded System

User's Manual



Disclaimers

This manual has been carefully checked and believed to contain accurate information. Axiomtek Co., Ltd. assumes no responsibility for any infringements of patents or any third party's rights, and any liability arising from such use.

Axiomtek does not warrant or assume any legal liability or responsibility for the accuracy, completeness or usefulness of any information in this document. Axiomtek does not make any commitment to update the information in this manual.

Axiomtek reserves the right to change or revise this document and/or product at any time without notice.

No part of this document may be reproduced, stored in a retrieval system, or transmitted, in any form or by any means, electronic, mechanical, photocopying, recording, or otherwise, without the prior written permission of Axiomtek Co., Ltd.

©Copyright 2019 Axiomtek Co., Ltd.

All Rights Reserved

Dec 2019, Version A2

Printed in Taiwan

Safety Precautions

Before getting started, please read the following important safety precautions.

1. The eBOX560-500-FL does not come equipped with an operating system. An operating system must be loaded first before installing any software into the computer.
2. Be sure to ground yourself to prevent static charge when installing the internal components. Use a grounding wrist strap and place all electronic components in any static-shielded devices. Most electronic components are sensitive to static electrical charge.
3. Disconnect the power cord from the eBOX560-500-FL before making any installation. Be sure both the system and the external devices are turned OFF. Sudden surge of power could ruin sensitive components. Make sure the eBOX560-500-FL is properly grounded.
4. Make sure the voltage of the power source is correct before connecting the equipment to the power outlet.
5. Turn OFF the system power before cleaning. Clean the system using a cloth only. Do not spray any liquid cleaner directly onto the screen.
6. Do not leave this equipment in an uncontrolled environment where the storage temperature is below -40°C or above 80°C . It may damage the equipment.
7. Do not open the system's back cover. If opening the cover for maintenance is a must, only a trained technician is allowed to do so. Integrated circuits on computer boards are sensitive to static electricity. To avoid damaging chips from electrostatic discharge, observe the following precautions:
 - Before handling a board or integrated circuit, touch an unpainted portion of the system unit chassis for a few seconds. This will help to discharge any static electricity on your body.
 - When handling boards and components, wear a wrist-grounding strap, available from most electronic component stores.
8. CAUTION
 - RISK OF EXPLOSION IF BATTERY IS REPLACED BY AN INCORRECT TYPE
 - DISPOSE OF USED BATTERIES ACCORDING TO THE INSTRUCTIONS

Classification

1. Degree of protection against electric shock : not classified
2. Degree of protection against the ingress of water : IP40
3. Equipment not suitable for use in the presence of a flammable anesthetic mixture with air or with oxygen or nitrous oxide.
4. Mode of operation : Continuous

General Cleaning Tips

You may need the following precautions before you begin to clean the computer. When you clean any single part or component for the computer, please read and understand the details below fully.

When you need to clean the device, please rub it with a piece of dry cloth.

1. Be cautious of the tiny removable components when you use a vacuum cleaner to absorb the dirt on the floor.
2. Turn the system off before you start to clean up the component or computer.
3. Never drop the components inside the computer or get circuit board damp or wet.
4. Be cautious of all kinds of cleaning solvents or chemicals when you use it for the sake of cleaning. Some individuals may be allergic to the ingredients.
5. Try not to put any food, drink or cigarette around the computer.

Cleaning Tools:

Although many companies have created products to help improve the process of cleaning your computer and peripherals users can also use household items to clean their computers and peripherals. Below is a listing of items you may need or want to use while cleaning your computer or computer peripherals.

Keep in mind that some components in your computer may only be able to be cleaned using a product designed for cleaning that component, if this is the case it will be mentioned in the cleaning.

- Cloth: A piece of cloth is the best tool to use when rubbing up a component. Although paper towels or tissues can be used on most hardware as well, we still recommend you to rub it with a piece of cloth.
- Water or rubbing alcohol: You may moisten a piece of cloth a bit with some water or rubbing alcohol and rub it on the computer. Unknown solvents may be harmful to the plastics parts.
- Vacuum cleaner: Absorb the dust, dirt, hair, cigarette particles, and other particles out of a computer can be one of the best methods of cleaning a computer. Over time these items can restrict the airflow in a computer and cause circuitry to corrode.
- Cotton swabs: Cotton swabs moistened with rubbing alcohol or water are excellent tools for wiping hard to reach areas in your keyboard, mouse, and other locations.
- Foam swabs: Whenever possible it is better to use lint free swabs such as foam swabs.



Note: *We strongly recommended that you should shut down the system before you start to clean any single components.*

Please follow the steps below:

1. Close all application programs
2. Close operating software
3. Turn off power switch
4. Remove all device
5. Pull out power cable

Scrap Computer Recycling

If the computer equipment's needs the maintenance or are beyond repair, we strongly recommended that you should inform your Axiomtek distributor as soon as possible for the suitable solution. For the computers that are no longer useful or no longer working well, please contact your Axiomtek distributor for recycling and we will make the proper arrangement.

Trademarks Acknowledgments

Axiomtek is a trademark of Axiomtek Co., Ltd.

IBM, PC/AT, PS/2, VGA are trademarks of International Business Machines Corporation.

Intel[®] and Pentium[®] are registered trademarks of Intel Corporation.

MS-DOS, Microsoft C and QuickBasic are trademarks of Microsoft Corporation.

Windows 8.1, Windows 10, Linux and other brand names and trademarks are the properties and registered brands of their respective owners.

Table of Contents

Disclaimers.....	ii
Safety Precautions.....	iii
Classification.....	iv
General Cleaning Tips	v
Scrap Computer Recycling.....	vi
CHAPTER 1 INTRODUCTION	1
1.1 General Description.....	1
1.2 System Specifications	2
1.2.1 CPU	2
1.2.2 I/O System	2
1.2.3 System Specification.....	3
1.2.4 Driver CD Content.....	3
1.3 Dimensions	4
1.3.1 System Dimension.....	4
1.3.2 Wall mount Bracket Dimension.....	5
1.3.3 Din-rail mount Bracket Dimension.....	6
1.3.4 VESA mount Bracket Dimension.....	7
1.4 I/O Outlets.....	8
1.5 Packing List.....	9
CHAPTER 2 HARDWARE INSTALLATION.....	11
2.1 Installing the 2.5" SATA Device	11
2.2 Installing the Express Mini Card.....	13
2.3 Installing the SO-DIMM Memory	15
CHAPTER 3 JUMPER SETTING & CONNECTOR.....	17
3.1 Jumper & Connector Location.....	17
3.2 Jumper Setting Summary.....	19
3.2.1 Restore BIOS Optimal Defaults (JP1)	19
3.2.2 AT/ATX Quick Switch	20
3.3 Connectors	21
3.3.1 DC Power Jack w/ Screw (CN14).....	22
3.3.2 Ethernet Port (LAN1/LAN2)	22
3.3.3 HDMI Connector (CN15).....	22
3.3.4 COM Serial Port Connector	23
3.3.5 USB 3.0 Connector	24
3.3.6 System Power Switch.....	25
3.3.7 System Reset Switch.....	25
3.3.8 Express Mini Card Slot.....	26
3.3.9 Power and HDD LED Indicator	26
CHAPTER 4 BIOS SETUP UTILITY	27
4.1 Starting	27
4.2 Navigation Keys	27
4.3 Main Menu	28

4.4	Advanced Menu.....	29
4.5	Chipset Menu	39
4.6	Security Menu	46
4.7	Boot Menu	47
4.8	Save & Exit Menu	48
APPENDIX A WATCHDOG TIMER.....		51
	About Watchdog Timer	51
	How to Use Watchdog Timer	51
	Sample Program	51

CHAPTER 1 INTRODUCTION



This chapter contains general information and detailed specifications of the eBOX560-500-FL. The Chapter 1 includes the following sections:

- General Description
- System Specifications
- Dimensions
- I/O Outlets
- Packing List
- Model List

1.1 General Description

The eBOX560-500-FL is an embedded system that supports Intel® Core™ i7-6600U 3.4 GHz/ Celeron®3955U 2.0 GHz onboard to support Windows 8.1, Windows 10, AXVIEW 2.0 and Linux, suitable for the most enduring operation.

It features fan less design with full feature I/O, one 260-pin unbuffered SODIMM socket for one channel DDR4-2133 MHz memory, and enhanced system dependability by built-in Watchdog Timer.

● Features

1. 6th generation Intel® Core™ i7-6600U 3.4 GHz / Celeron®3955U 2.0 GHz
2. Maximum up to 16 GB SO-DIMM DDR4- 2133 MHz memory capacity
3. Fan-less design with compact size
4. Supports 4 USB 3.0 ports
5. Supports 1 RS-232/422/485 and 1 RS-232
6. Supports 2 10/100/1000Mbps Ethernet ports
(One port support Wake on LAN,PXE Boot ROM with i219LM)

7. Supports ATX power button
 8. Supports Reset button
 9. Two HDMI
 10. One 2.5" SATA HDD drive bay
 11. One PCI Express Mini Card Slots w/ mSATA supported.
 12. Watchdog timer
 13. 12V DC power input
 14. Two Antenna openings
 15. One AT/ATX mode quick switch
 16. Option Wall / VESA / DIN Rail Mounting Kits
- **Reliable and Stable Design**
The eBOX560-500-FL adopts the advanced cooling system and supporting the mSATA, which makes it especially suitable for vibration environments, best for industrial automation, digital signage and gaming application.
 - **Embedded O.S. Supported**
The eBOX560-500-FL not only supports Windows 8, Windows 8.1, and Windows 10 but also supports embedded OS, such as Windows 7 Embedded, Windows 8 Embedded, Windows 10 IoT and Linux.
 - **Various Storage devices supported**
For storage device, the eBOX560-500-FL supports one 2.5" SATA storage drive bay and one mSATA device.

1.2 System Specifications

1.2.1 CPU

- **CPU**
 - Intel®Core™ i7-6600U 3.4 GHz / Celeron®3955U 2.0 GHz
- **Chipset**
 - Intel® Braswell quad-core SoC
- **BIOS**
 - American Megatrends Inc. UEFI (Unified Extensible Firmware Interface) BIOS.
- **System Memory**
 - One 260-pin unbuffered DDR4-2133 MHz SO-DIMM socket, max. up to 16 GB

1.2.2 I/O System

- One jumper-less RS-232/422/485 9-pin D-Sub male connector (COM1)
- One RS-232 9-pin D-Sub male connector (COM2)
- Two HDMI for display (FHD)
- Two RJ-45 connectors for 10/100/1000 Base-T Ethernet ports (i210AT & i219LM)
- Four USB 3.0 connectors
- One PCI Express Mini Card Slots w/ mSATA supported.
- One Reset switch
- One ATX Power switch
- Two SMA type connector opening for Antenna

- 12 VDC Power jack connector
- Two Indicators LED (System Power, HDD Active)
- One AT/ATX Quick switch

1.2.3 System Specification

- **Watchdog Timer**
 - 1~255 seconds or minutes; up to 255 levels.
- **Power Supply**
 - Input : 12VDC
- **Operation Temperature**
 - -10°C ~+50°C (-14°F~+122°F), with W.T. SSD & Memory
- **Storage Temperature**
 - -40°C ~ 80°C (-40 °F ~ 176°F)
- **Humidity**
 - 10% ~ 90% (non-condensation)
- **Vibration Endurance**
 - 3Grm w/ SSD (5-500Hz, X, Y, Z directions)
- **Weight**
 - 0.8 kg(1.76lb) without package
 - 1.67 kg(3.68lb) with package
- **Dimensions**
 - 141.5 mm(5.57") (W) x 106 mm(4.17") (D) x 55 mm(2.17") (H)

1.2.4 Driver CD Content

- **Driver**
 - Chipset
 - Ethernet
 - Graphic
 - USB 3.0 hot fix for Windows 8.x
 - ME
- **Manual**
 - User Manual
 - Quick Manual



Note: All specifications and images are subject to change without notice.

1.3.2 Wall mount Bracket Dimension

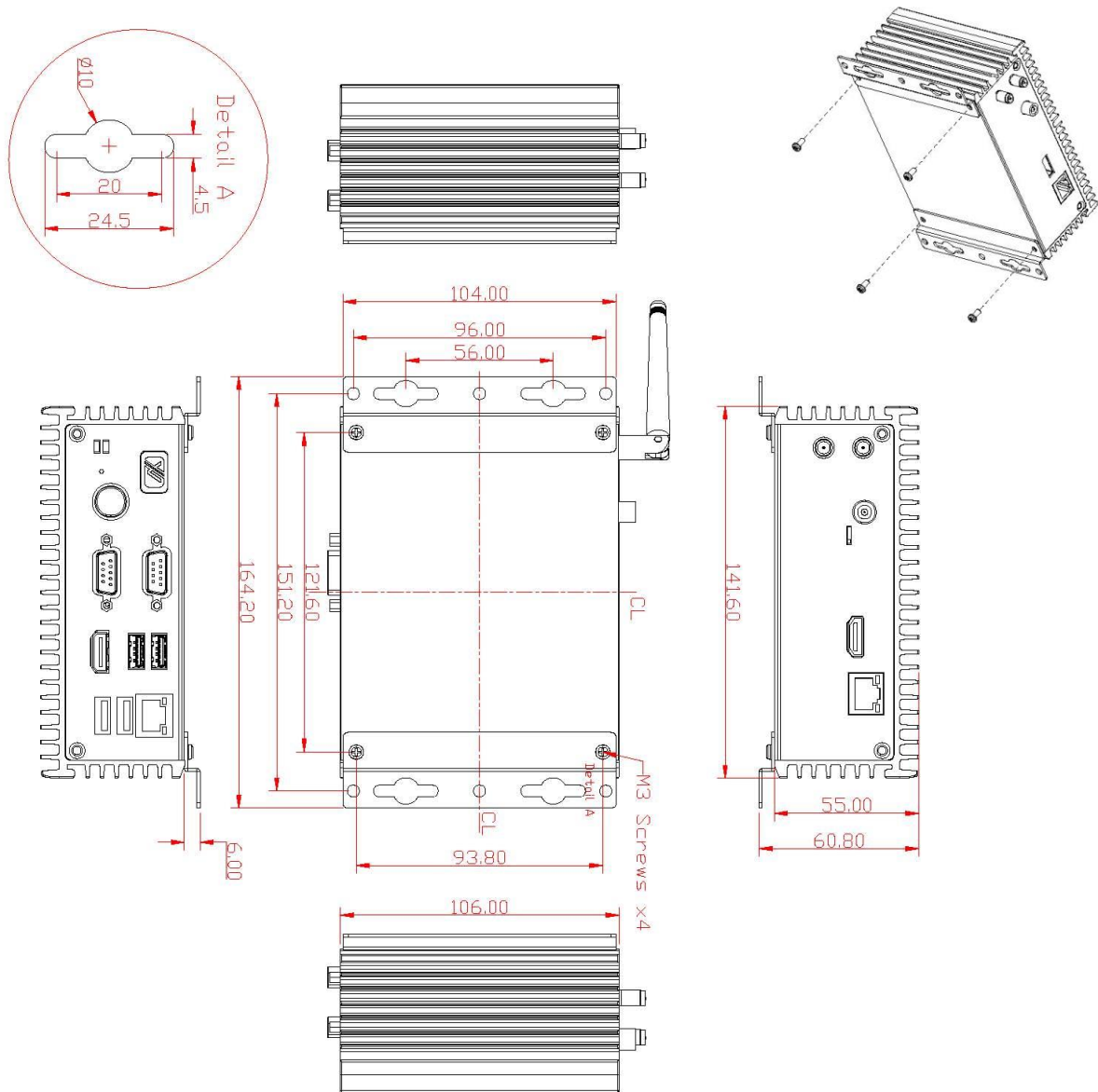

Instruction

Step 1: Screw the two pieces of wall-mount kits to the bottom plate of the device. Total four screws (**metric 3 x6**) are required.

Step 2: Use the device, with wall mount plate attached, as a guide to mark the correct locations of the four screws.

Step 3: Insert a tapping-screw (**thread diameter less than 4mm**) head through middle of the keyhole-shaped aperture on the plate, and then slide the device downwards. Tighten the screw head for added stability.

1.3.3 Din-rail mount Bracket Dimension

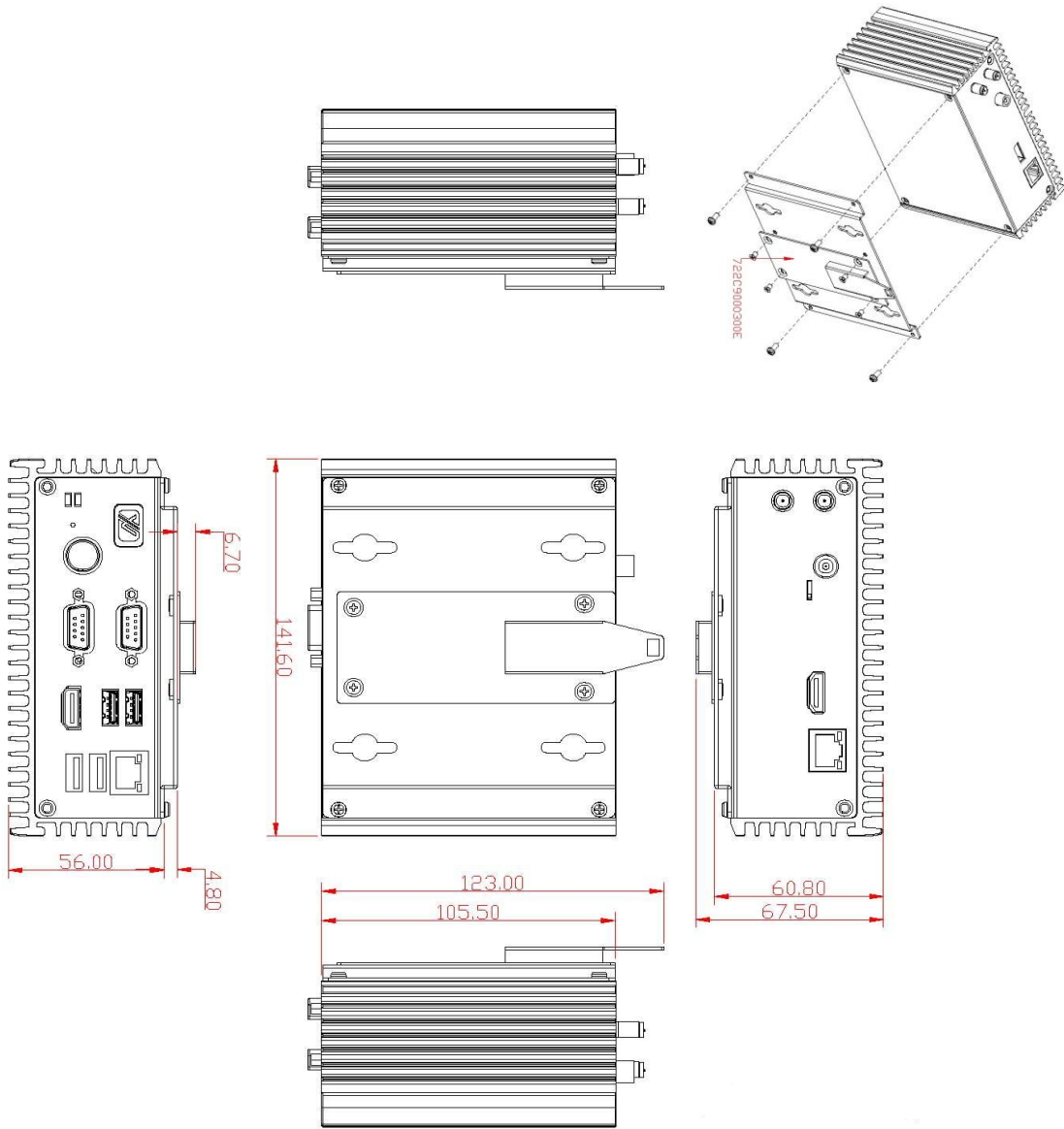

Instruction

Step 1: Screw the Din rail mount Bracket to the bottom plate of the device. Total of four screws (metric 3 x6) are required.

Step 2: Screw the Din rail bracket (722C9000300E) and the Din rail mount bracket together. Total four screws (Flat Head M3 x4) are required.

Step 3: Users can install the eBOX560 in din-rail bracket through din-rail bracket kit.

1.3.4 VESA mount Bracket Dimension

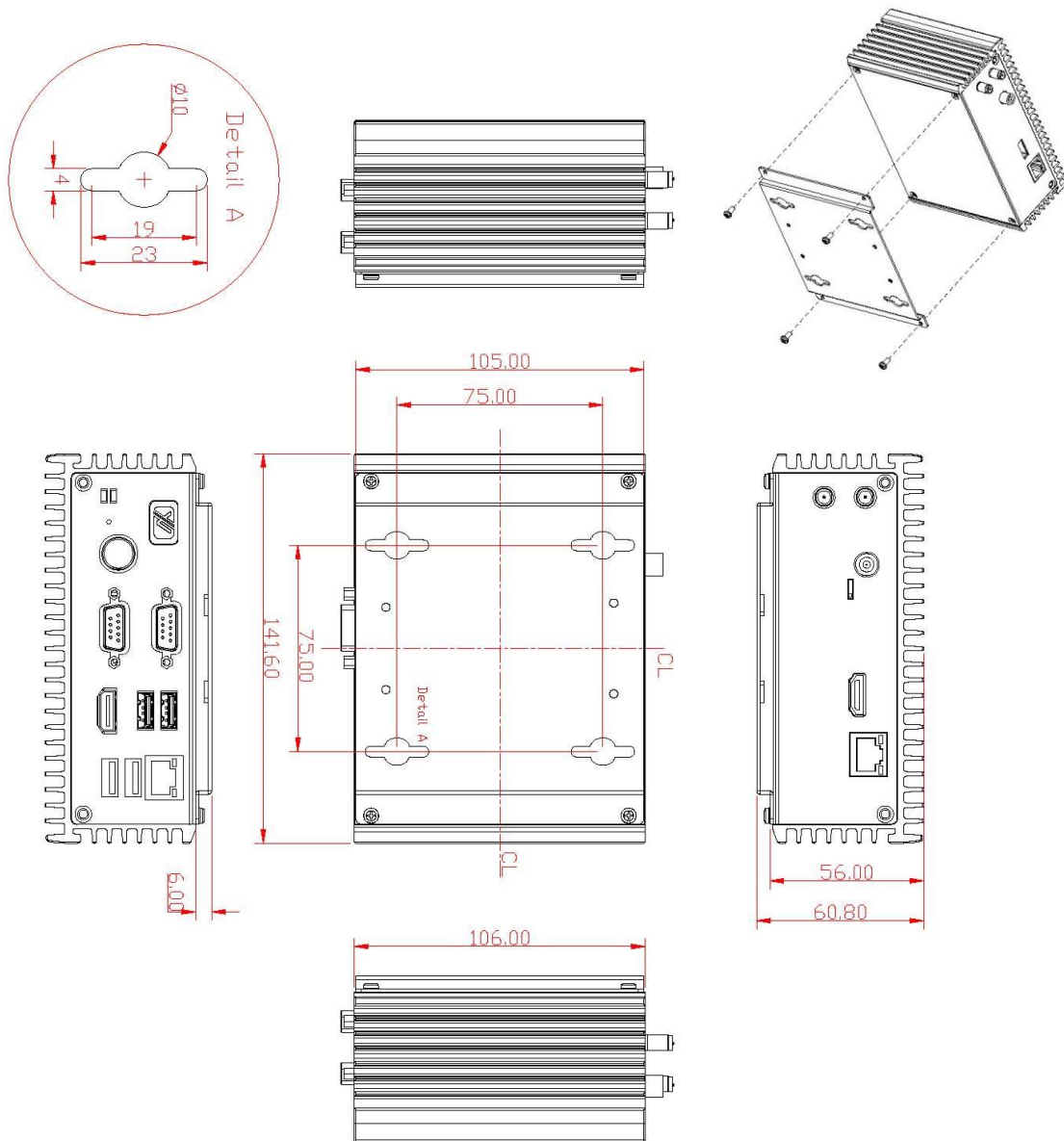

Instruction

Step 1: Please refer to above photo to screw the VESA mount bracket kit with the bottom plate of the device. Total four screws (**metric 3 x6**) are required.

Step 2: Insert four screws into the VESA hole of monitor and reserved a gap about **1.2~1.5mm**.

Step 3: Users can hang the eBOX560 through VESA bracket on the monitor.

1.4 I/O Outlets

The following figures show you I/O outlets on front view of the eBOX560-500-FL.

- Front View drawing

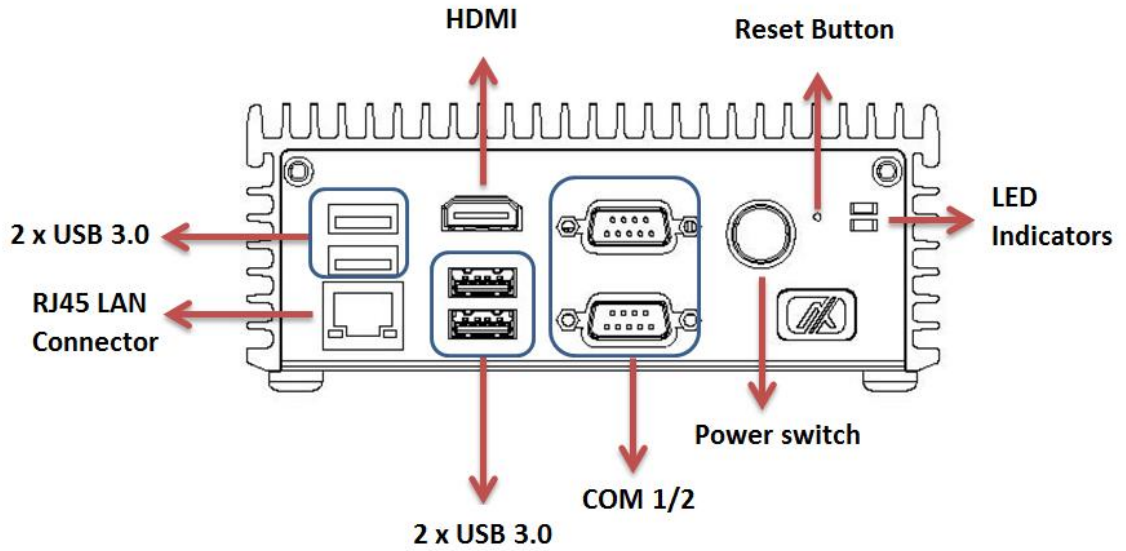

- Rear View drawing

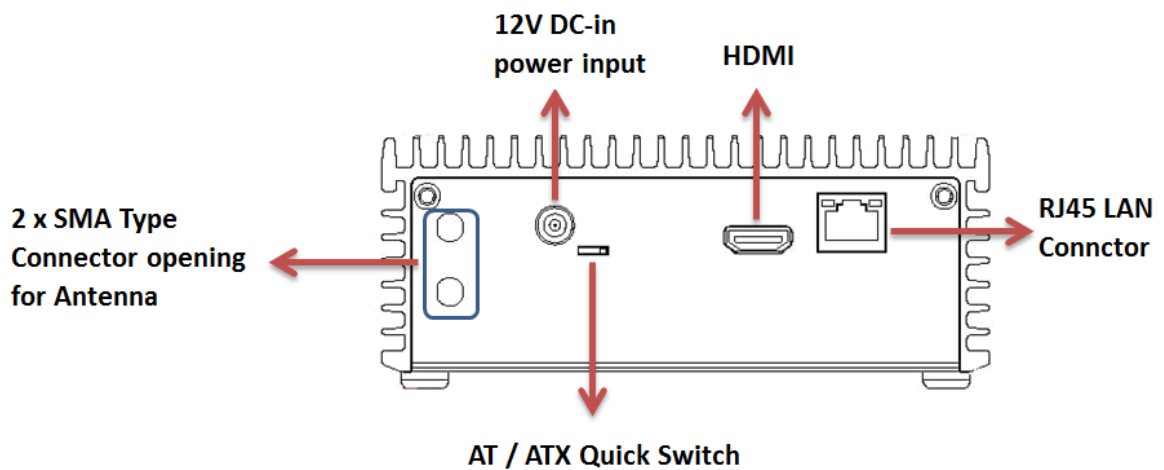

1.5 Packing List

The package bundled with your eBOX560-500-FL should contain the following items:

- **eBOX560-500-FL System Unit x 1**
- **eBOX560-500-FL Quick Installation Guide x 1**
- **DVD x 1 (For Driver and Manual)**
- **Screws Pack x 1**
- **Pre-installed Foot pad x 4**
- **Optional 12V/60W adapter**
- **Optional Power cord**
- **Optional DDR4 SO-DIMM Memory**
- **Optional Wall-mount kit**
- **Optional VESA / DIN-Rail kit**
- **Optional Antenna**
- **Optional Mini Card module**
- **Optional 2.5" SATA Storage**
- **Optional mSATA**

If you cannot find this package or any items are missing, please contact Axiomtek distributors immediately.

This page is intentionally left blank.

CHAPTER 2 HARDWARE INSTALLATION

The eBOX560-500-FL is convenient for your various hardware configurations, such as HDD (Hard Disk Drive), SSD (Solid State Drive) or PCI Express Mini Card modules. The chapter 2 will show you how to install the hardware.

2.1 Installing the 2.5" SATA Device

Step 1 Turn off the system, and unplug the power adaptor.

Step 2 Turn the system upside down to locate screws at the bottom, loosen screws.



Step 3 Remove the bottom cover.

Step 4 Please find the HDD bracket location then loosen four screws of HDD bracket to take out it.

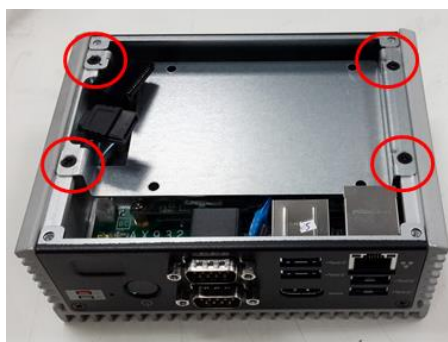

Step 5 Please prepare the following items to assemble HDD.



Step 6 Fasten total four screws to fix HDD/SSD.



※ Please notice that you should base on the photo to check the direction of HDD.

Step 7 Lock the HDD and fasten screws then connect SATA & Power cables.

Step 8 Please fasten screws of HDD bracket to complete first HDD installation.



2.2 Installing the Express Mini Card

Step 1 Turn off the system, and unplug the power adaptor.

Step 2 Turn the system upside down to locate screws at the bottom, loosen screws.



Step 3 Remove the HDD bracket then find Mini Card location.

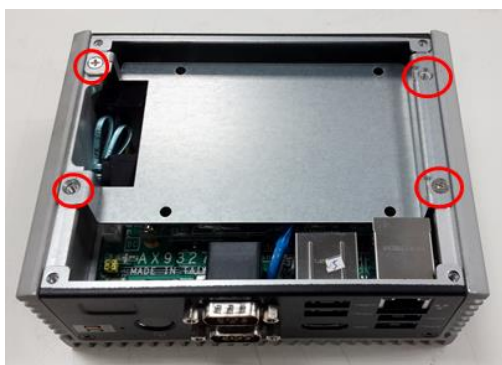

Step 4 Please follow your requirement to connect PCI Express Mini Card module, EX: WIFI, mSATA and GPS

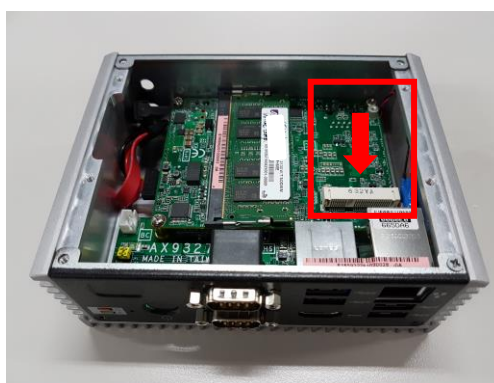

Step 5 Slide Mini Card into Mini Card slot with caution, and fasten screw of Express Mini Card.



Step 6 Assembly the bottom cover back and fasten all screws.

2.3 Installing the SO-DIMM Memory

Step 1 Turn off the system, and unplug the power adaptor.

Step 2 Turn the system upside down to locate screws at the bottom, loosen screws.



Step 3 Please find the HDD bracket location then loosen four screws of HDD bracket to take out it.

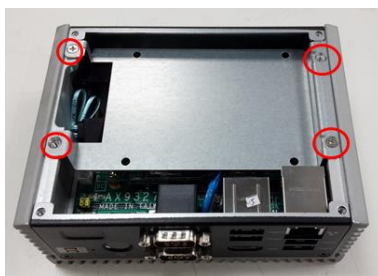

Step 4 Then insert your memory into the slot carefully.



Step 5 Finally, please fasten the HDD bracket and bottom cover to complete installation.

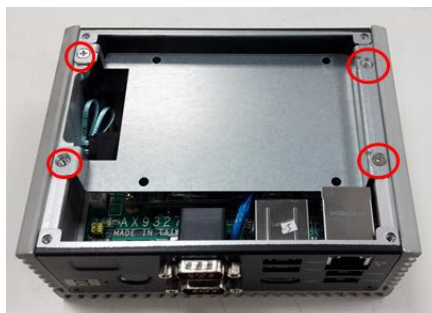

This page is intentionally left blank.

CHAPTER 3 JUMPER SETTING & CONNECTOR

Proper jumper settings configure the eBOX560-500-FL to meet your application purpose. We are here with listing a summary table of all jumpers and default settings for onboard devices, respectively.

3.1 Jumper & Connector Location

PICO500 Top Side

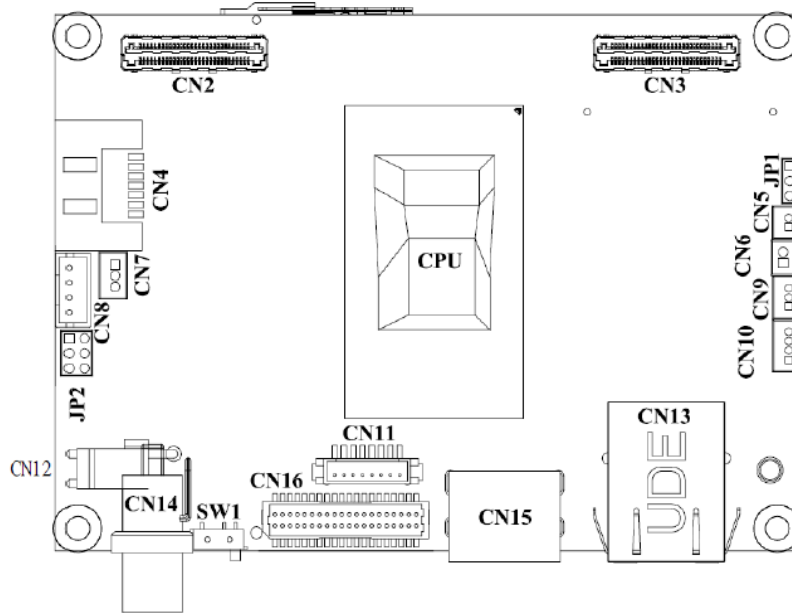

PICO500 Bottom Side

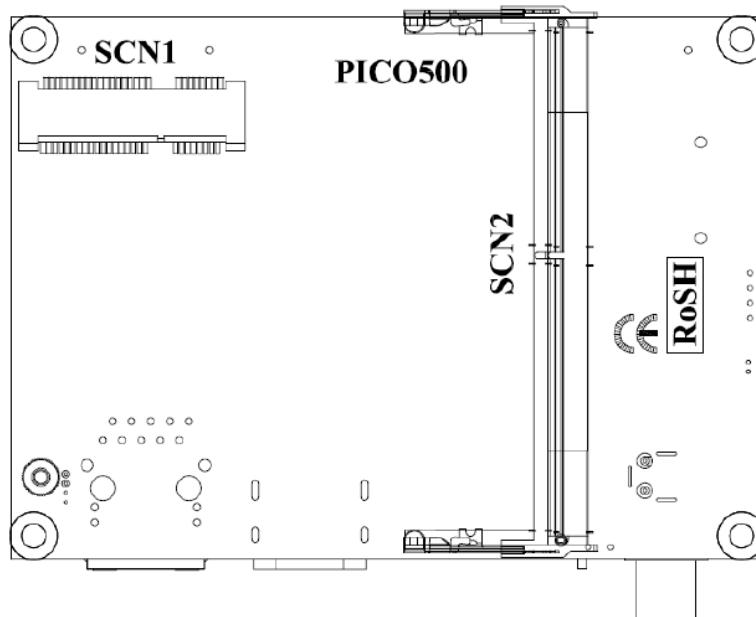

AX93276 Top Side

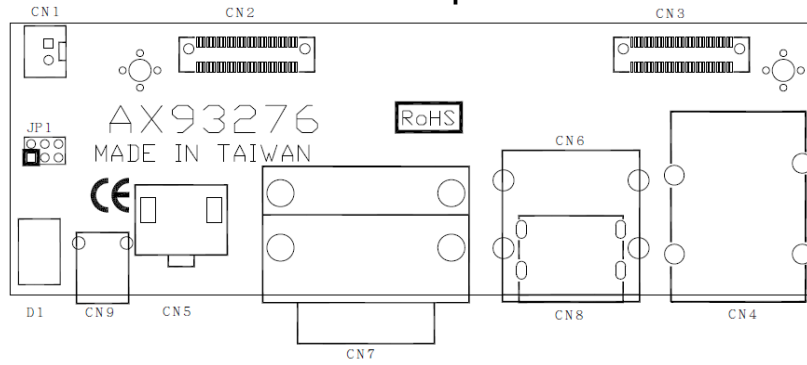

AX93276 Bottom Side

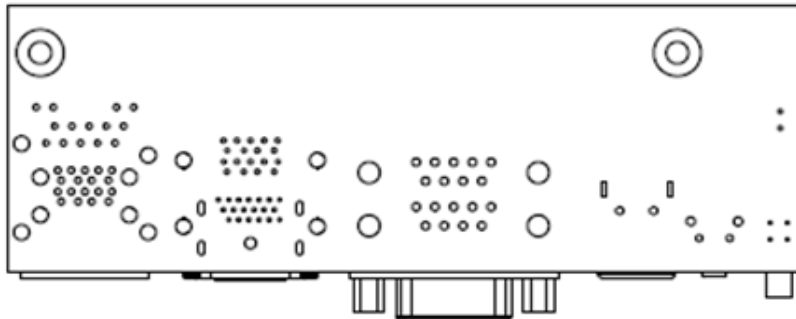

Note: We strongly recommended that you should not modify any unmentioned jumper setting without Axiomtek FAE's instruction. Any modification without instruction might cause system to become damage.

3.2 Jumper Setting Summary

Proper jumper settings configure the eBOX560-500-FL to meet your application purpose. We are herewith listing a summary table of all jumpers and default settings for onboard devices, respectively.

PICO500:

Jumper	Function/Default Setting	Jumper Setting
JP1	Restore BIOS Optimal Defaults Default: Normal Operation	1-2 Close
JP2	LVDS Voltage Selection Default: +3.3V Level	1-2 Close
SW1	AT / ATX quick switch	Default: ATX Mode

AX93276 I/O Board:

Jumper	Function/Default Setting	Jumper Setting	
JP1	COM1 Data/Power Selection Default: RS-232 Data	CN7B Pin 1: DCD	3-5 Close
		CN7B Pin 9: RI	4-6 Close



Note: How to setup Jumpers

The illustration shows how to set up jumpers. When the jumper cap is placed on pins, the jumper is “close”, if not, that means the jumper is “open”.

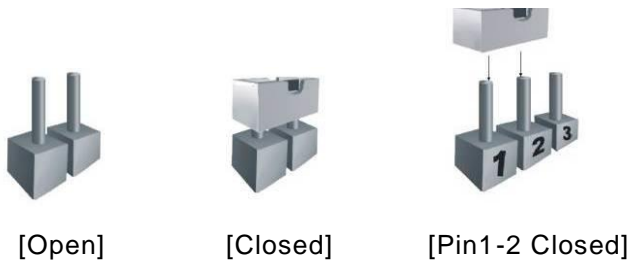

3.2.1 Restore BIOS Optimal Defaults (JP1)

Put jumper clip to pin 2-3 for a few seconds then move it back to pin 1-2. Doing this procedure can restore BIOS optimal defaults.

Function	Setting
Normal (Default)	1-2
Restore BIOS optimal defaults	2-3



3.2.2 AT/ATX Quick Switch

If SW1 is enabled for power input, the system will be automatically power on without pressing soft power button. If SW1 is disabled for power input, it is necessary to manually press soft power button to power on the system.

Function
AT Mode
ATX Mode (Default)



3.3 Connectors

Connectors connect the board with other parts of the system. Loose or improper connection might cause problems. Make sure all connectors are properly and firmly connected. Here is a summary table shows you all connectors and button on the **eBOX560-500-FL** Series.

External Connectors / Buttons	Section
DC Power Jack w/ Screw	3.3.1
LAN Port	3.3.2
HDMI Connector	3.3.3
COM Serial Port Connector	3.3.4
USB 3.0 Connector	3.3.5
System Power Button	3.3.6
System Reset Button	3.3.7
PCI Express Mini Card interface	3.3.8
Power and HDD LED Indicator	3.3.9

3.3.1 DC Power Jack w/ Screw (CN14)

The CN14 is a DC jack with screw. Firmly insert at least 60W adapter into this connector. Loose connection may cause system instability and make sure all components/devices are properly installed before connecting.

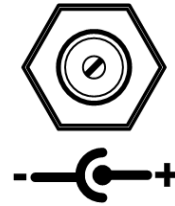

3.3.2 Ethernet Port (LAN1/LAN2)

The board has one RJ-45 Ethernet connector. Connection can be established by plugging one end of the Ethernet cable into this RJ-45 connector and the other end (phone jack) to a 1000/100/10-Base-T hub.

Pin	Signal	Pin	Signal
L1	MDI0P	L5	MDI2P
L2	MDI0N	L6	MDI2N
L3	MDI1P	L7	MDI3P
L4	MDI1N	L8	MDI3N
A	Active LED (Yellow)		
B	100 LAN LED (Green) / 1000 LAN LED (Orange)		

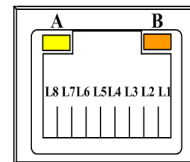

3.3.3 HDMI Connector (CN15)

The HDMI (High-Definition Multimedia Interface) is a compact digital interface which is capable of transmitting high-definition video and high-resolution audio over a single cable.

Pin	Signal	Pin	Signal
1	HDMI OUT_DATA2+	2	GND
3	HDMI OUT_DATA2-	4	HDMI OUT_DATA1+
5	GND	6	HDMI OUT_DATA1-
7	HDMI OUT_DATA0+	8	GND
9	HDMI OUT_DATA0-	10	HDMI OUT_Clock+
11	GND	12	HDMI OUT_Clock-
13	N.C.	14	N.C.
15	HDMI OUT_SCL	16	HDMI OUT_SDA
17	GND	18	+5V
19	HDMI_HTPLG		

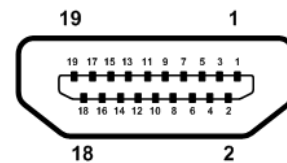

3.3.4 COM Serial Port Connector

The system has two serial ports. COM1 is RS-232/422/485 ports and COM2 is RS-232, please refer to Chapter 4 for the detail of BIOS setting. The lower connector (CN7A) is for COM2 and the upper connector (CN7B) is for COM1.

CN7B Pin	RS-232	RS-422	RS-485
1	DCD, Data Carrier Detect	TX-	Data-
2	RXD, Receive Data	TX+	Data+
3	TXD, Transmit Data	RX+	No use
4	DTR, Data Terminal Ready	RX-	No use
5	GND, Ground	No use	No use
6	DSR, Data Set Ready	No use	No use
7	RTS, Request To Send	No use	No use
8	CTS, Clear To Send	No use	No use
9	RI, Ring Indicator	No use	No use

CN7B

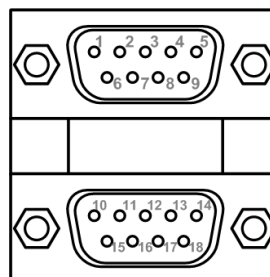

CN7A

CN7A Pin	Signal
10	Data Carrier Detect (DCD)
11	Receive Data (RXD)
12	Transmit Data (TXD)
13	Data Terminal Ready (DTR)
14	Ground (GND)
15	Data Set Ready (DSR)
16	Request to Send (RTS)
17	Clear to Send (CTS)
18	Ring Indicator (RI)

3.3.5 USB 3.0 Connector

The Universal Serial Bus connectors are compliant with USB 3.0 (5Gb/s), and ideally for installing USB peripherals such as keyboard, mouse, scanner, etc.

Pin	Signal USB Port 0	Pin	Signal USB Port 1
1	USB_VCC (+5V level standby power)	10	USB_VCC (+5V level standby power)
2	USB_Data2-	11	USB_Data3-
3	USB_Data2+	12	USB_Data3+
4	GND	13	GND
5	SSRX2-	14	SSRX3-
6	SSRX2+	15	SSRX3+
7	GND	16	GND
8	SSTX2-	17	SSTX3-
9	SSTX2+	18	SSTX3+

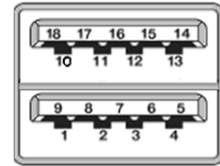

3.3.6 System Power Switch

This button is for turning on/off the system power.

Function	Description
On	Turn on/off system
Off	Keep system status

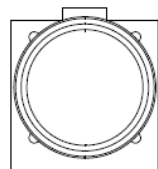

3.3.7 System Reset Switch

This button reboots your computer without turning off the power supply. It is a better way to reboot your system for a longer life of the system power supply.

Function	Description
On	Reset system
Off	Keep system status



3.3.8 Express Mini Card Slot

This is a PCI-Express Mini Card connector on the bottom side supporting PCI-Express x1 link and USB 2.0 link. It complies with PCI-Express Mini Card Spec. V1.2. A PCI-Express Mini Card can be applied to either PCI-Express, USB 2.0 or SATA (mSATA). To enable or disable mSATA support, please refer to BIOS setting in section 4.4. The default setting is PCI-Express.

Pin	Signal	Pin	Signal
1	WAKE#	2	+3.3VSB
3	No use	4	GND
5	No use	6	+1.5V
7	CLKREQ#	8	No use
9	GND	10	No use
11	REFCLK-	12	No use
13	REFCLK+	14	No use
15	GND	16	No use
17	No use	18	GND
19	No use	20	W_DISABLE#
21	GND	22	PERST#
23	PE_RXN3/SATA_RXP	24	+3.3VSB
25	PE_RXP3/SATA_RXN	26	GND
27	GND	28	+1.5V
29	GND	30	SMB_CLK
31	PE_TXN3/SATA_TXN	32	SMB_DATA
33	PE_TXP3/SATA_TXP	34	GND
35	GND	36	USB_D8-
37	GND	38	USB_D8+
39	+3.3VSB	40	GND
41	+3.3VSB	42	No use
43	GND	44	No use
45	No use	46	No use
47	No use	48	+1.5V
49	No use	50	GND
51	No use	52	+3.3VSB

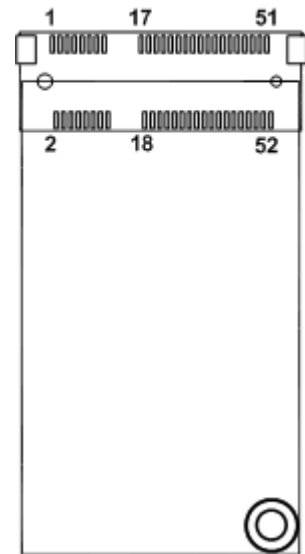

3.3.9 Power and HDD LED Indicator

The Red LED is linked to Hard Disk Drive (HDD) activity signal. LED flashes every time HDD is accessed.

The power LED (green) lights up and will remain steady while the system is powered on.

LED Color	Description
Green	Power on/off
Red	Hard disk drive activity



CHAPTER 4

BIOS SETUP UTILITY

This chapter provides users with detailed description how to set up basic system configuration through the BIOS setup utility.

4.1 Starting

To enter the setup screens, follow the steps below:

1. Turn on the computer and press the key immediately.
2. After you press the key, the main BIOS setup menu displays. You can access the other setup screens from the main BIOS setup menu, such as the Advanced and Chipset menus.

It is strongly recommended that you should avoid changing the chipset's defaults. Both AMI and your system manufacturer have carefully set up these defaults that provide the best performance and reliability.

4.2 Navigation Keys

The BIOS setup/utility uses a key-based navigation system called hot keys. Most of the BIOS setup utility hot keys can be used at any time during the setup navigation process. These keys include <F1>, <F2>, <Enter>, <ESC>, <Arrow> keys, and so on.



Note: Some of the navigation keys differ from one screen to another.

Hot Keys	Description
→← Left/Right	The Left and Right <Arrow> keys allow you to select a setup screen.
↑↓ Up/Down	The Up and Down <Arrow> keys allow you to select a setup screen or sub-screen.
+– Plus/Minus	The Plus and Minus <Arrow> keys allow you to change the field value of a particular setup item.
Tab	The <Tab> key allows you to select setup fields.
F1	The <F1> key allows you to display the General Help screen.
F2	The <F2> key allows you to Load Previous Values.
F3	The <F3> key allows you to Load Optimized Defaults.
F4	The <F4> key allows you to save any changes you have made and exit Setup. Press the <F4> key to save your changes.
Esc	The <Esc> key allows you to discard any changes you have made and exit the Setup. Press the <Esc> key to exit the setup without saving your changes.
Enter	The <Enter> key allows you to display or change the setup option listed for a particular setup item. The <Enter> key can also allow you to display the setup sub- screens.

4.3 Main Menu

The first time you enter the setup utility, you will enter the Main setup screen. You can always return to the Main setup screen by selecting the Main tab. System Time/Date can be set up as described below. The Main BIOS setup screen is shown below.

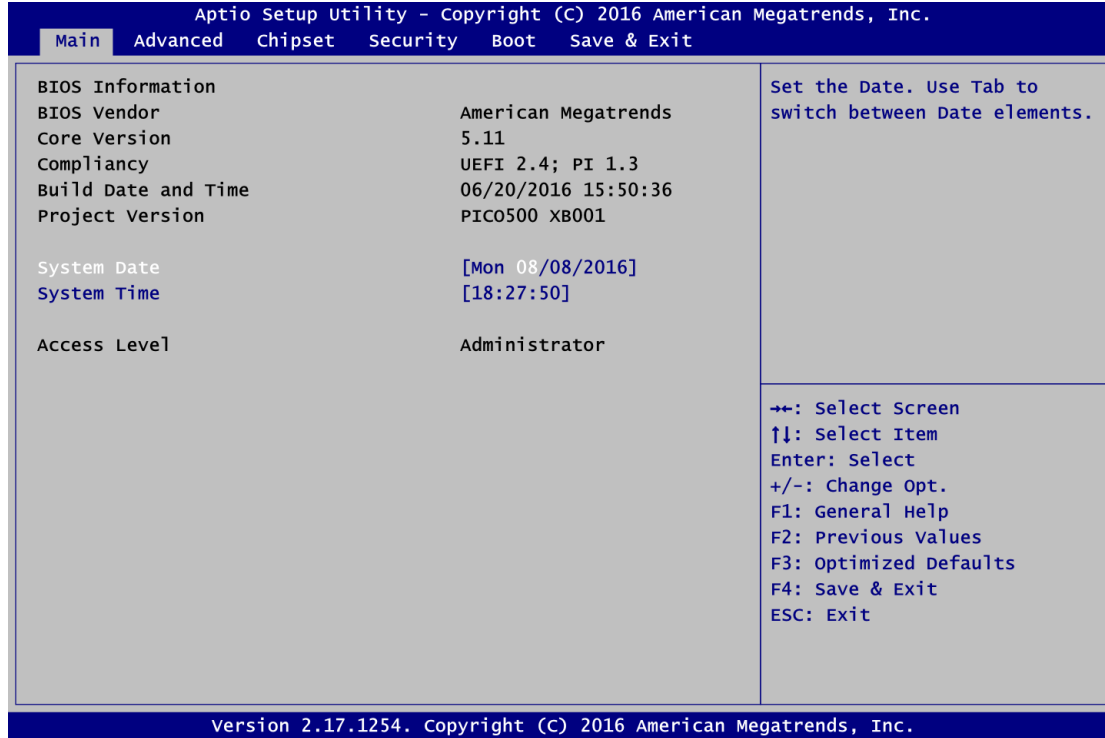

BIOS Information/Version

Display the auto-detected BIOS detail information.

System Date/Time

Use this option to change the system time and date. Highlight System Time or System Date using the <Arrow> keys. Enter new values through the keyboard. Press the <Tab> key or the <Arrow> keys to move between fields. The date must be entered in MM/DD/YY format. The time is entered in HH:MM:SS format.

Access Level

Display the access level of current user.

4.4 Advanced Menu

The Advanced menu also allows users to set configuration of the CPU and other system devices. You can select any of the items in the left frame of the screen to go to the sub menus:

- ▶ Hardware Monitor
- ▶ ACPI Settings
- ▶ CPU Configuration
- ▶ SATA Configuration
- ▶ PCH-FW Configuration
- ▶ AMT Configuration
- ▶ USB Configuration
- ▶ Intel RC Drivers Version Detail
- ▶ Utility Configuration

For items marked with “▶”, please press <Enter> for more options.

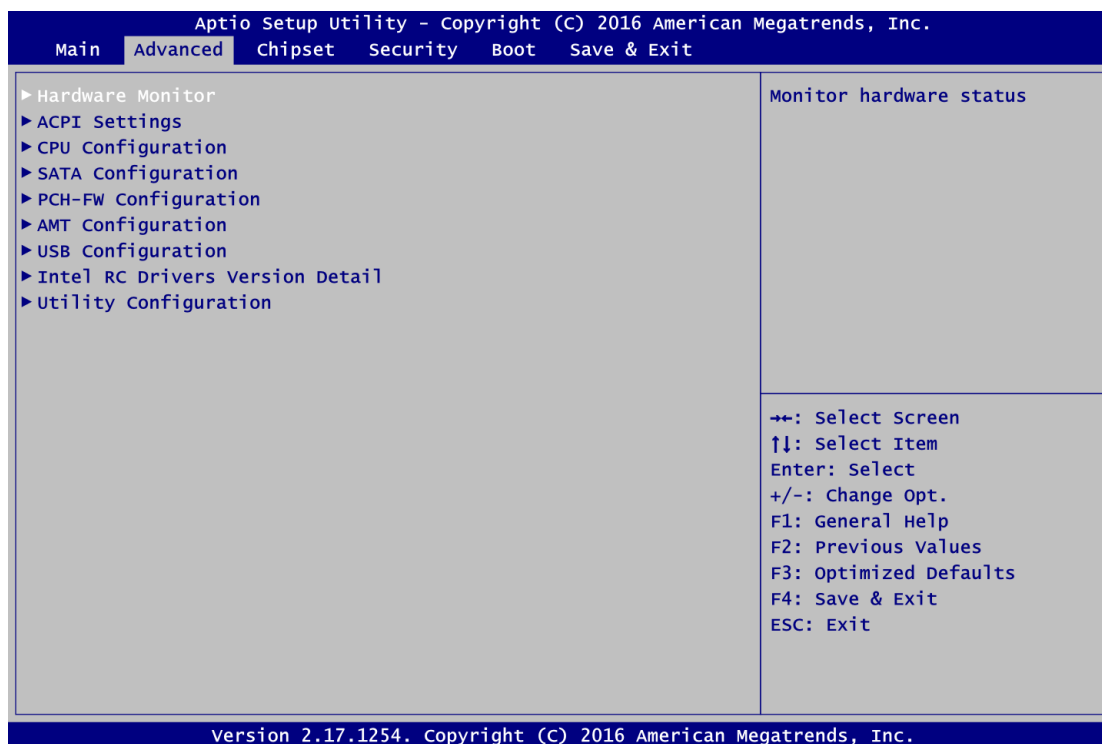

- **Hardware Monitor**

This screen monitors hardware health status.

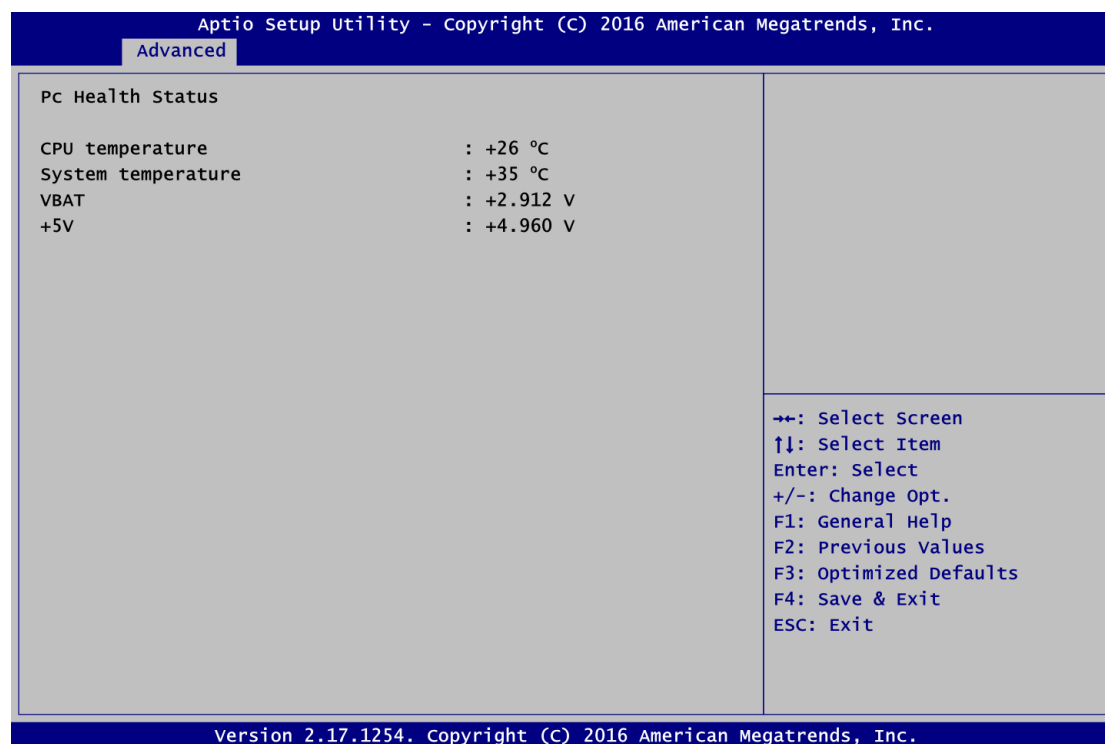

- **ACPI Settings**

You can use this screen to select options for the ACPI configuration, and change the value of the selected option. A description of the selected item appears on the right side of the screen.

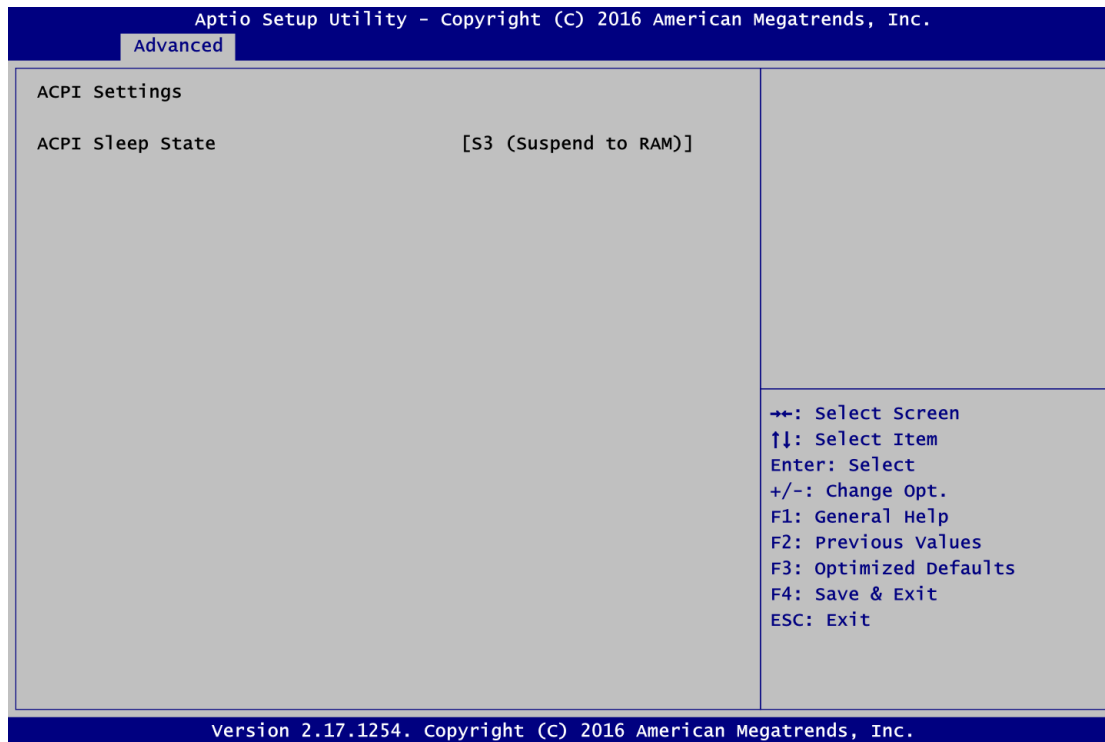
**ACPI Sleep State**

When the suspend button is pressed, the ACPI sleep state is S3 (Suspend to RAM).

● SATA Configuration

In this Configuration menu, you can see the currently installed hardware in the SATA ports. During system boot up, the BIOS automatically detects the presence of SATA devices.

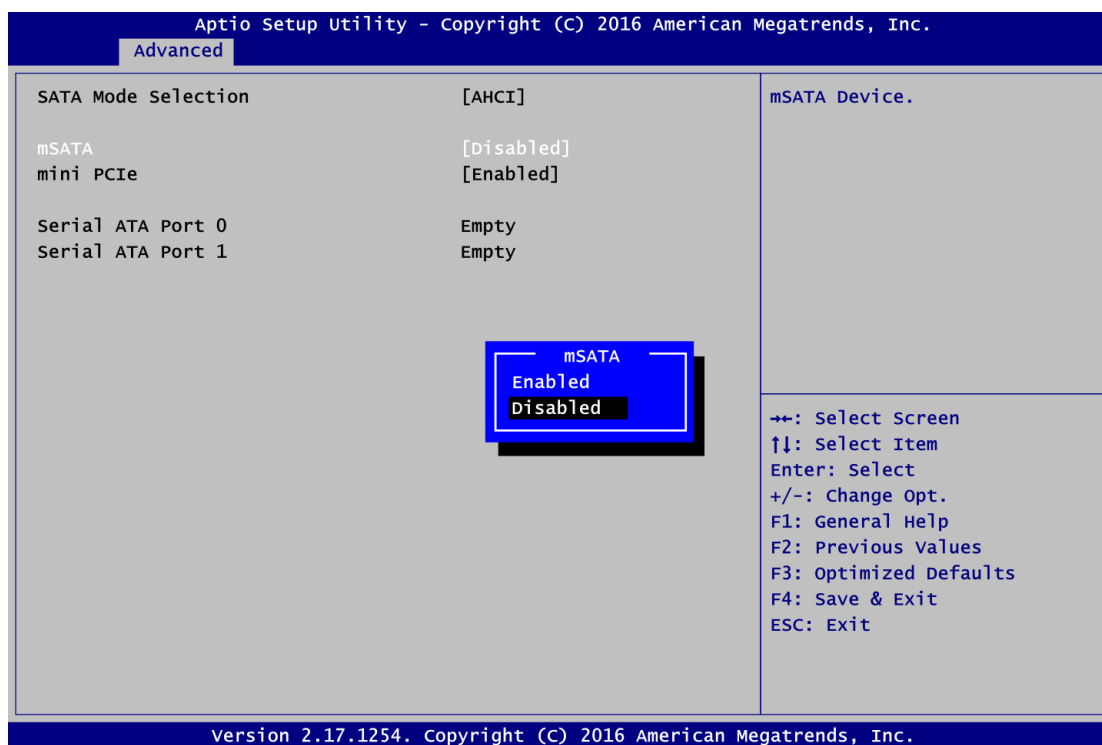

SATA Mode Selection

AHCI (Advanced Host Controller Interface) mode is how SATA controller(s) operate.

Mini PCIe Card Function

- **mSATA**

Enable or disable mSATA device. The default is Disabled.

- **PCIe**

When mSATA is enabled, PCIe is disabled automatically and vice versa.

Serial ATA Port 0

It shows the device installed in connector SATA0.

Serial ATA Port 1

It shows the device installed in connector SATA1.

- PCH-HW

This screen displays ME Firmware information.

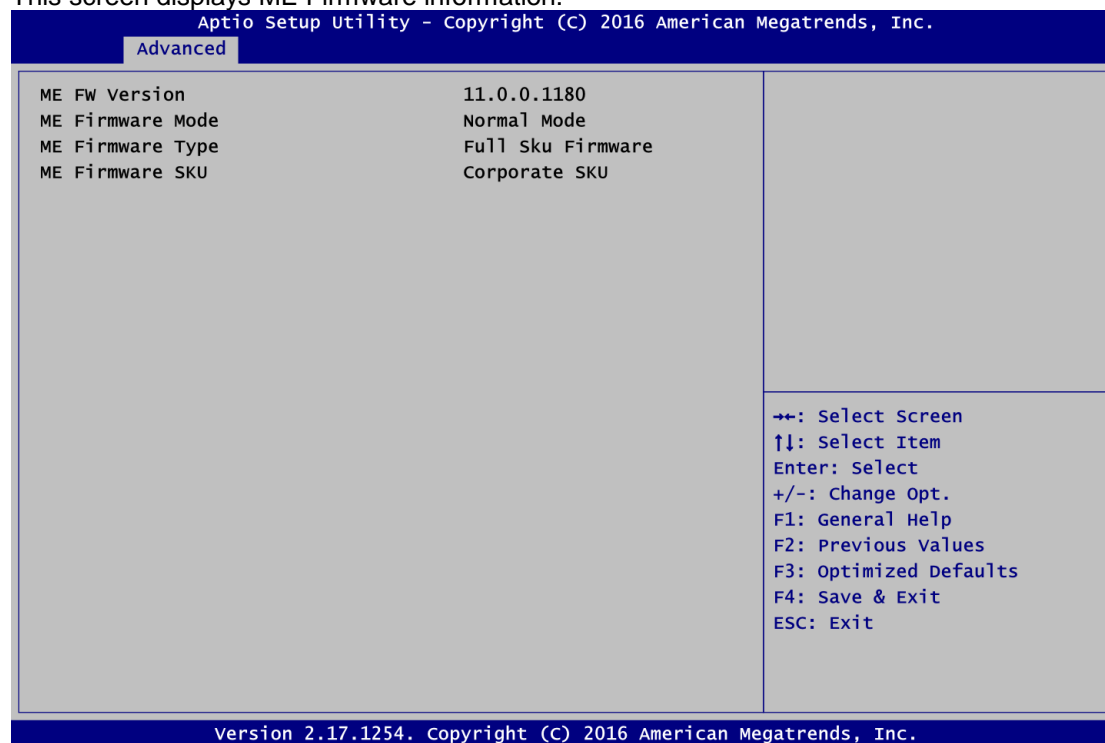

- **AMT Configuration**

Use this screen to configure AMT parameters.

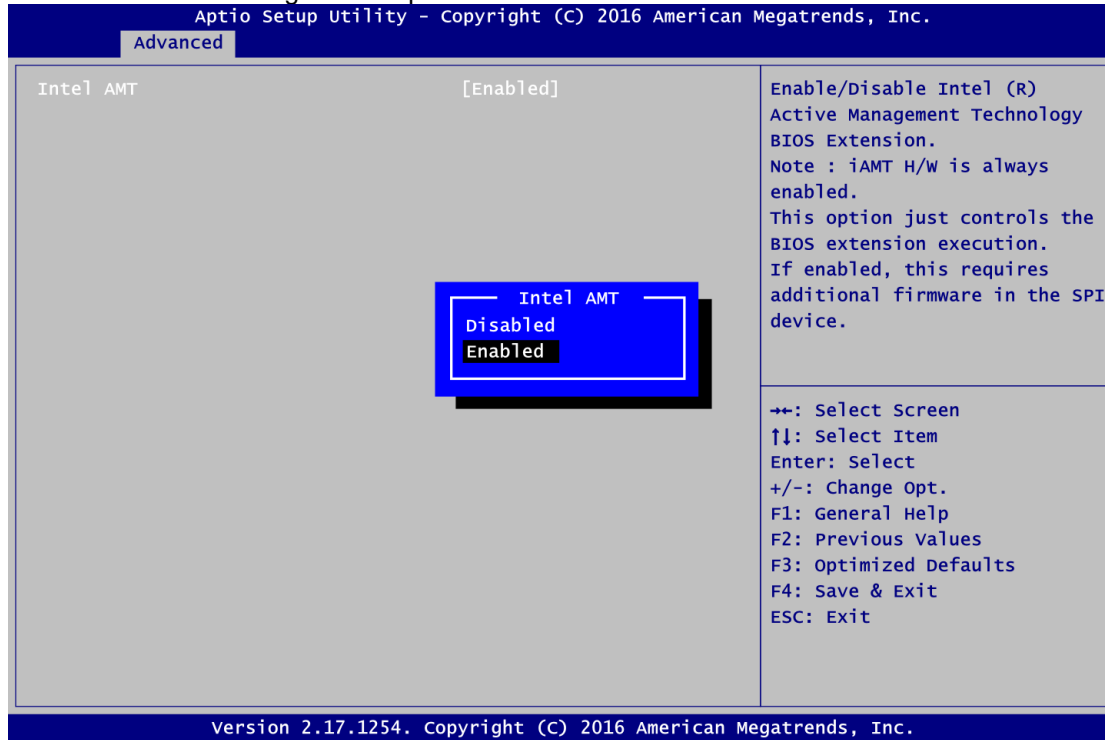

Intel AMT

Enable or disable Intel® Active Management Technology BIOS Extension.
The default is Enabled.

- **USB Configuration**

The screenshot shows the Aptio Setup Utility interface. At the top, it says "Aptio Setup Utility - Copyright (C) 2016 American Megatrends, Inc." and "Advanced" is selected. The main menu is titled "USB Configuration". Below it, "USB Module Version" is set to "12". Under "USB Devices:", there is "1 Keyboard". A list of navigation keys is provided on the right side of the screen.

Aptio Setup Utility - Copyright (C) 2016 American Megatrends, Inc.	
Advanced	
USB Configuration	
USB Module Version	12
USB Devices:	
1 Keyboard	
	→+: Select Screen ↑↓: Select Item Enter: Select +/-: Change Opt. F1: General Help F2: Previous Values F3: Optimized Defaults F4: Save & Exit ESC: Exit
Version 2.17.1254. Copyright (C) 2016 American Megatrends, Inc.	

USB Devices

Display all detected USB devices.

- Intel RC Drivers Version Detail

This screen displays Intel® RC driver's version information.

Aptio Setup Utility - Copyright (C) 2016 American Megatrends, Inc.

Advanced

Intel CPU RC Version	0.0.0.3
Intel SA RC Version	N/A
Intel PCH RC Version	0.0.0.1
Intel ACPI RC Version	N/A
Intel ME RC Version	N/A

→+: Select Screen
↑↓: Select Item
Enter: Select
+/-: Change Opt.
F1: General Help
F2: Previous Values
F3: Optimized Defaults
F4: Save & Exit
ESC: Exit

Version 2.17.1254. Copyright (C) 2016 American Megatrends, Inc.

- **Utility Configuration**

This screen for Bios flash utility

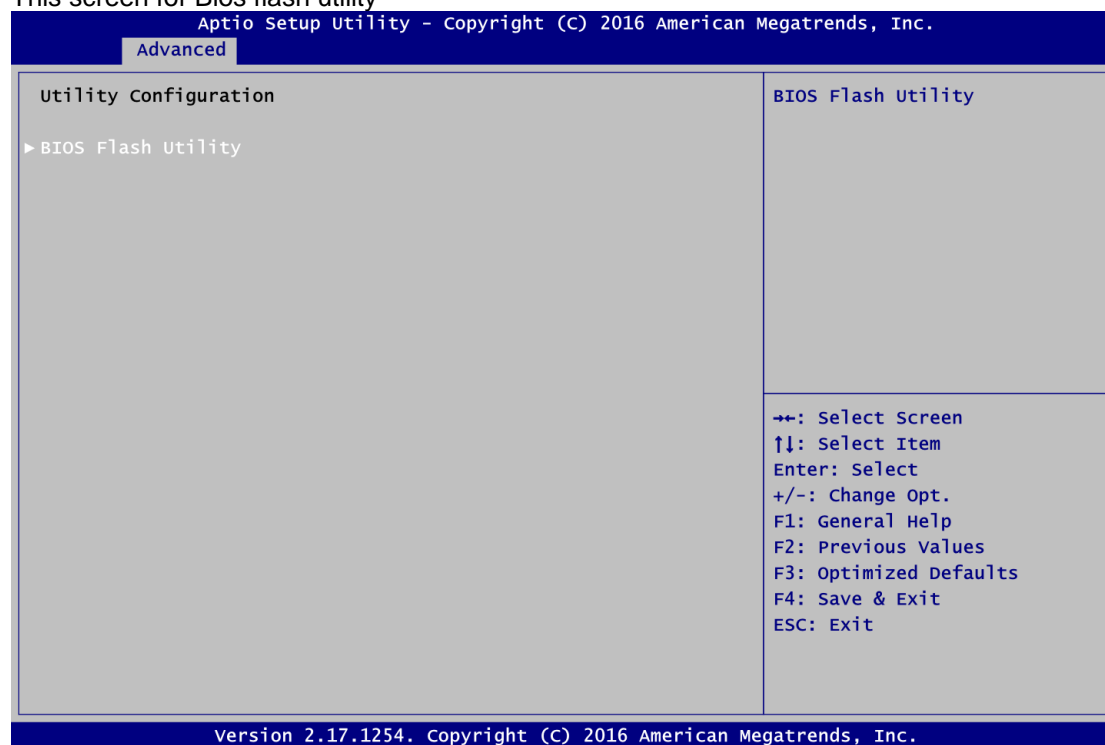

BIOS Flash Utility

BIOS flash utility configuration.

4.5 Chipset Menu

The Chipset menu allows users to change the advanced chipset settings. You can select any of the items in the left frame of the screen to go to the sub menus:

- ▶ PCH-IO Configuration
- ▶ System Agent (SA) Configuration

For items marked with “▶”, please press <Enter> for more options.

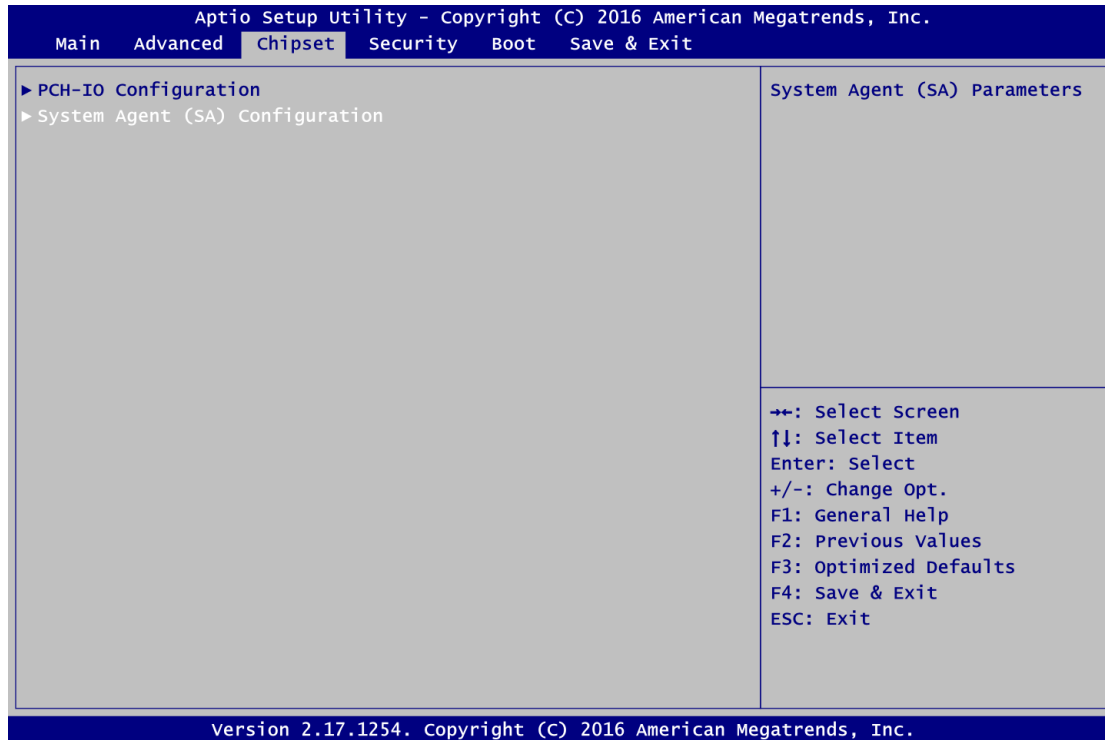

- **PCH-IO Configuration**

This screen allows you to set PCH parameters.

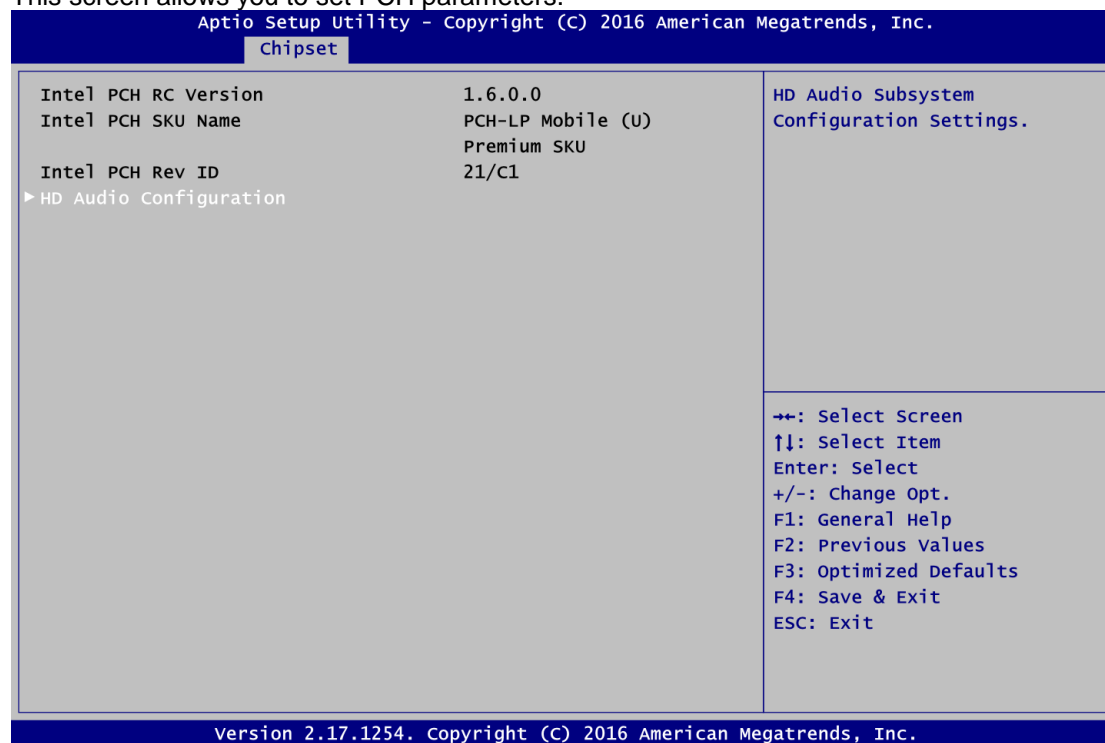

- **HD Audio Configuration**

Control detection of the HD Audio device. Configuration options are Disabled and Enabled.

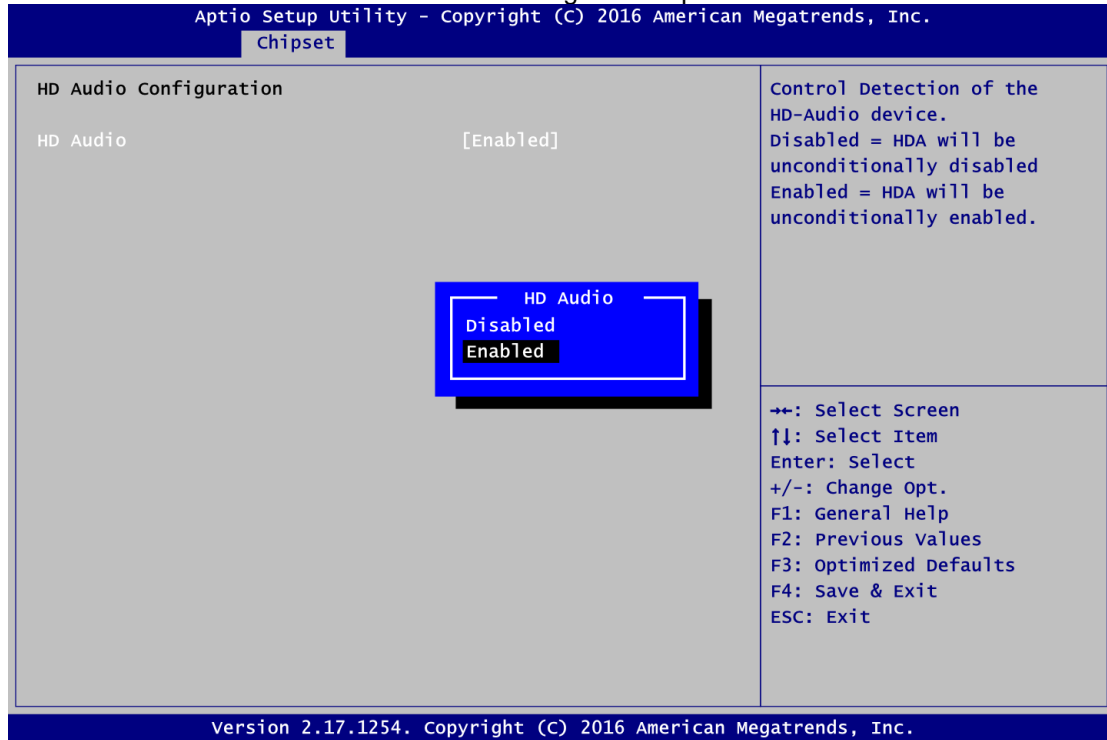

HD Audio Configuration

Use this item for HD Audio configuration settings.

- **System Agent (SA) Configuration**

This screen shows System Agent version information and provides function for specifying related parameters.

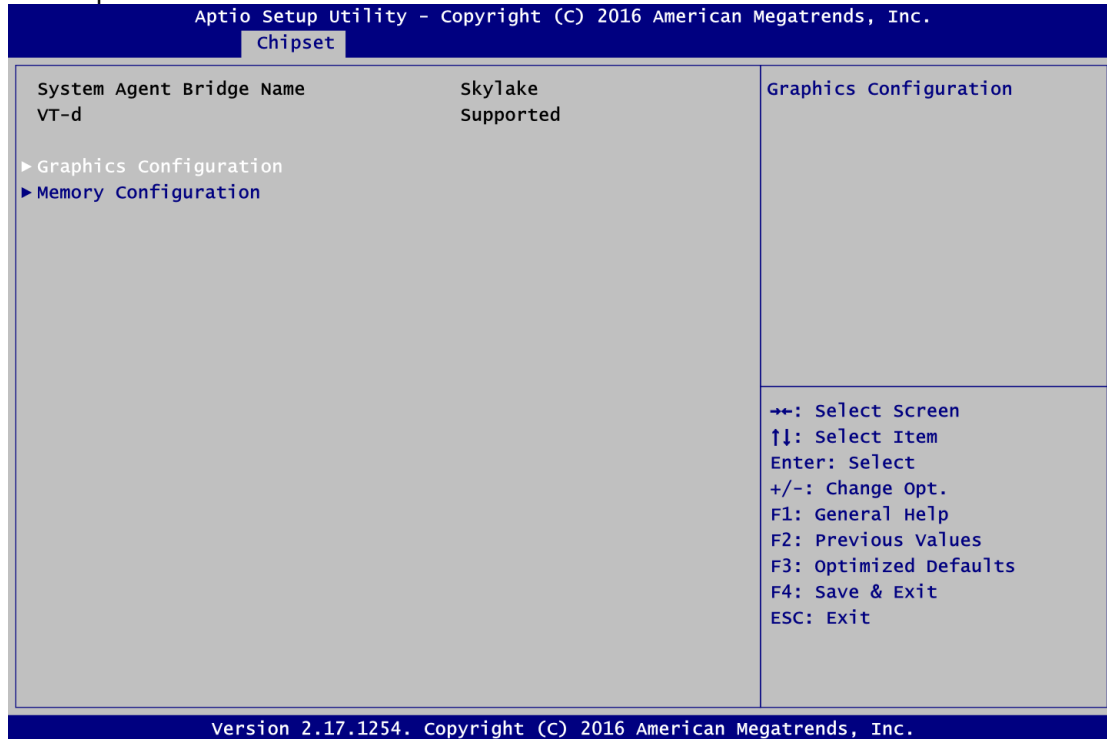

Graphics Configuration

Use this item to configure internal graphics controller.

Memory Configuration

Use this item to refer to the information related to system memory.

● Graphics Configuration

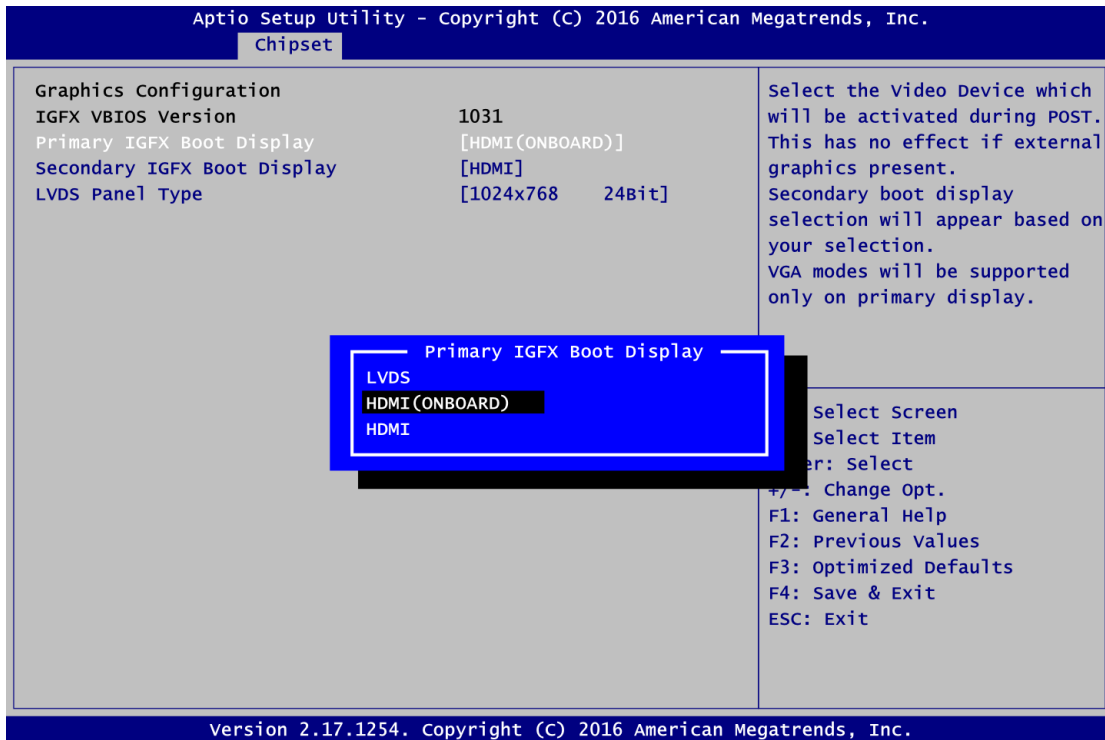

Primary IGFX Boot Display

Select the video device which will be activated during POST (Power-On Self Test). The default is HDMI(ONBOARD). The image above shows option list in Primary IGFX Boot Display when no I/O board is installed.



Note: When powering on Ebox560-500 for the first time, video device must be plugged into HDMI connector (CN15). Then, after first power on, you can set HDMI on AX93276 as primary IGFX boot display.



HDMI connector (CN15) on rear side

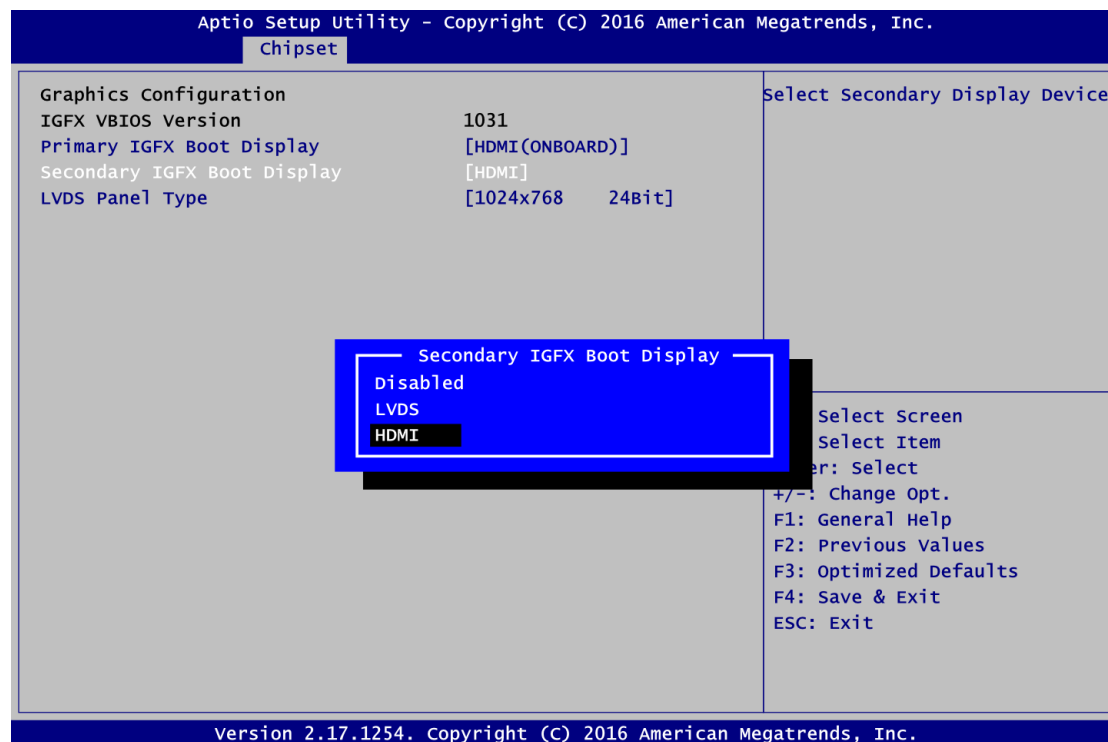

Secondary IGFX Boot Display

Select secondary display device. The default is Disabled.

- **Memory Information**

This screen shows the system memory information.

The screenshot displays the BIOS setup utility interface. At the top, it reads 'Aptio Setup Utility - Copyright (C) 2016 American Megatrends, Inc.' and 'Chipset'. The main area is titled 'Memory Configuration' and lists the following details:

Memory RC Version	1.6.0.1
Memory Frequency	2133 MHz
Total Memory	8192 MB
VDD	1200
DIMM#0	8192 MB
Memory Timings (tCL-tRCD-tRP-tRAS)	15-36

On the right side of the screen, a list of navigation keys is provided:

- +: Select Screen
- ↑↓: Select Item
- Enter: select
- +/-: Change Opt.
- F1: General Help
- F2: Previous Values
- F3: Optimized Defaults
- F4: Save & Exit
- ESC: Exit

At the bottom of the screen, it reads 'Version 2.17.1254. Copyright (C) 2016 American Megatrends, Inc.'

4.6 Security Menu

The Security menu allows users to change the security settings for the system.



Administrator Password

This item indicates whether an administrator password has been set (installed or uninstalled).

User Password

This item indicates whether an user password has been set (installed or uninstalled).

4.7 Boot Menu

The Boot menu allows users to change boot options of the system.

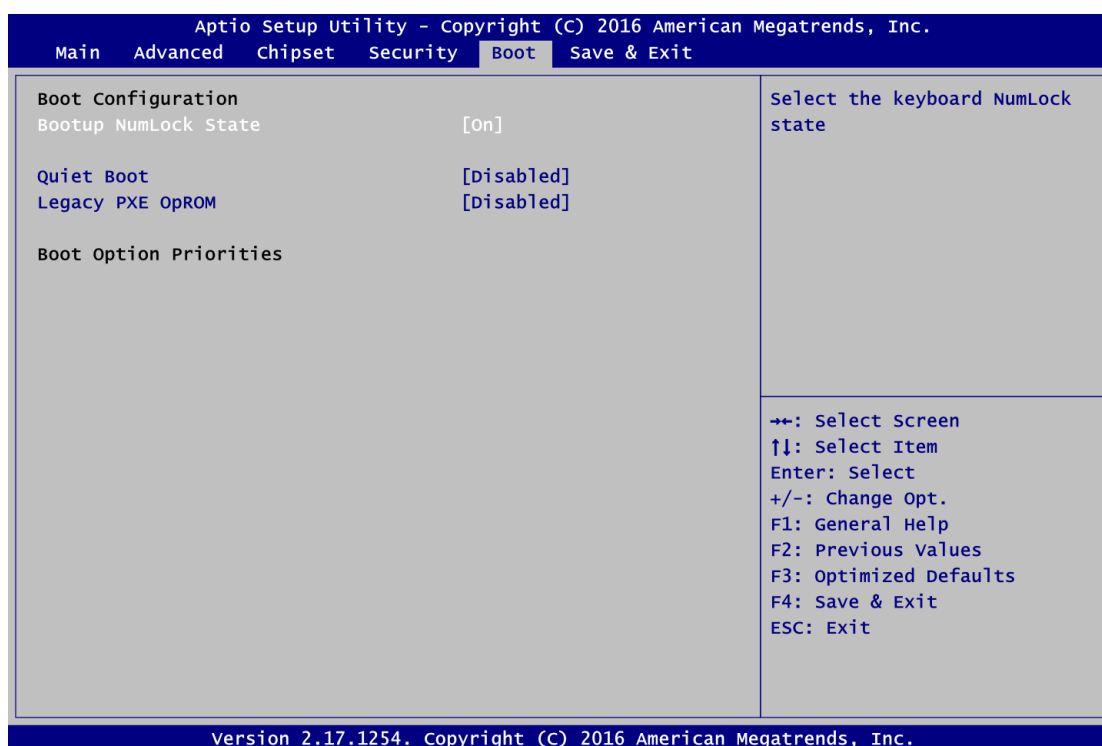

Bootup NumLock State

Use this item to select the power-on state for the keyboard NumLock.

Quiet Boot

Select to display either POST output messages or a splash screen during boot-up.

Legacy PXE OProm

Use this item to enable or disable the boot ROM function of the onboard LAN chip when the system boots up.

Boot Option Priorities

These are settings for boot priority. Specify the boot device priority sequence from the available devices.

4.8 Save & Exit Menu

The Save & Exit menu allows users to load your system configuration with optimal or fail-safe default values.

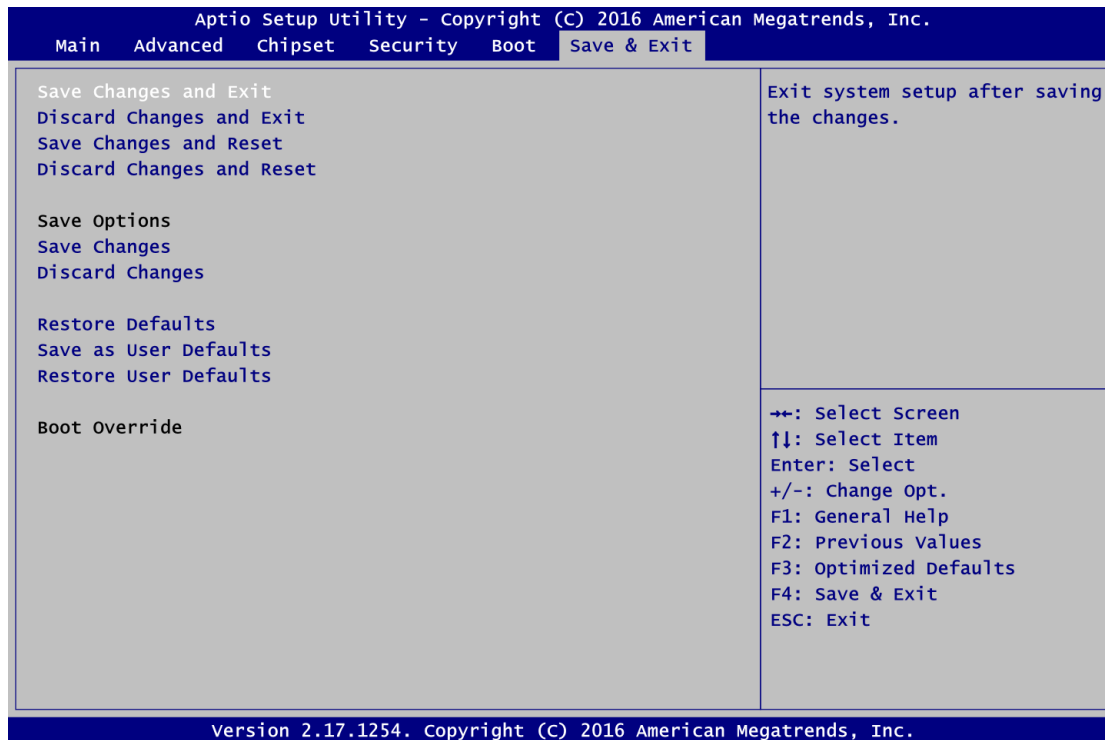

Save Changes and Exit

When you have completed the system configuration changes, select this option to leave Setup and return to Main Menu. Select Save Changes and Exit from the Save & Exit menu and press <Enter>. Select Yes to save changes and exit.

Discard Changes and Exit

Select this option to quit Setup without making any permanent changes to the system configuration and return to Main Menu. Select Discard Changes and Exit from the Save & Exit menu and press <Enter>. Select Yes to discard changes and exit.

Save Changes and Reset

When you have completed the system configuration changes, select this option to leave Setup and reboot the computer so the new system configuration parameters can take effect. Select Save Changes and Reset from the Save & Exit menu and press <Enter>. Select Yes to save changes and reset.

Discard Changes and Reset

Select this option to quit Setup without making any permanent changes to the system configuration and reboot the computer. Select Discard Changes and Reset from the Save & Exit menu and press <Enter>. Select Yes to discard changes and reset.

Save Changes

When you have completed the system configuration changes, select this option to save changes. Select Save Changes from the Save & Exit menu and press <Enter>. Select Yes to save changes.

Discard Changes

Select this option to quit Setup without making any permanent changes to the system configuration. Select Discard Changes from the Save & Exit menu and press <Enter>. Select Yes to discard changes.

Restore Defaults

It automatically sets all Setup options to a complete set of default settings when you select this option. Select Restore Defaults from the Save & Exit menu and press <Enter>.

Save as User Defaults

Select this option to save system configuration changes done so far as User Defaults. Select Save as User Defaults from the Save & Exit menu and press <Enter>.

Restore User Defaults

It automatically sets all Setup options to a complete set of User Defaults when you select this option. Select Restore User Defaults from the Save & Exit menu and press <Enter>.

Boot Override

Select a drive to immediately boot that device regardless of the current boot order.

This page is intentionally left blank.

APPENDIX A WATCHDOG TIMER

About Watchdog Timer

Software stability is major issue in most application. Some embedded systems are not watched by human for 24 hours. It is usually too slow to wait for someone to reboot when computer hangs. The systems need to be able to reset automatically when things go wrong. The watchdog timer gives us solution.

The watchdog timer is a counter that triggers a system reset when it counts down to zero from a preset value. The software starts counter with an initial value and must reset it periodically. If the counter ever reaches zero which means the software has crashed, the system will reboot.

How to Use Watchdog Timer

The I/O port base addresses of watchdog timer are 2E (hex) and 2F (hex). The 2E (hex) and 2F (hex) are address and data port respectively.

Assume that program A is put in a loop that must execute at least once every 10ms. Initialize watchdog timer with a value bigger than 10ms. If the software has no problems; watchdog timer will never expire because software will always restart the counter before it reaches zero.

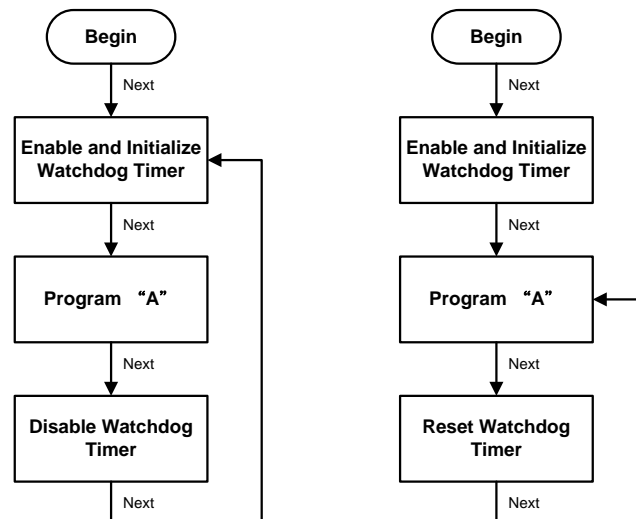

Sample Program

Assembly sample code:

;Enable WDT:

```
mov    dx,2Eh
mov    al,87          ;Un-lock super I/O
out    dx,al
out    dx,al
```

;Select Logic device:

```
mov    dx,2Eh
mov    al,07h
out    dx,al
mov    dx,2Fh
mov    al,08h
out    dx,al
```

;Activate WDT:

```
mov    dx,2Eh
mov    al,30h
out    dx,al
mov    dx,2Fh
mov    al,01h
out    dx,al
```

;Set Second or Minute :

```
mov    dx,2Eh
mov    al,0F5h
out    dx,al
mov    dx,2Fh
mov    al,Nh          ;N=00h or 08h(see below  Note)
out    dx,al
```

;Set base timer :

```
mov    dx,2Eh
mov    al,0F6h
out    dx,al
mov    dx,2Fh
mov    al,Mh          ;M=00h,01h,...FFh (hex),Value=0 to 255
```

```

out    dx,a1          ;(see below  Note)

;Disable WDT:
mov    dx,2Eh
mov    al,30h
out    dx,a1
mov    dx,2Fh
mov    al,00h        ;Can be disabled at any time
out    dx,a1

```

 **Note:**

If **N=00h**, the time base is set to second.

M = time value

00: Time-out Disable
01: Time-out occurs after 1 second
02: Time-out occurs after 2 seconds
03: Time-out occurs after 3 seconds
.
.
FFh: Time-out occurs after 255 seconds

If **N=08h**, the time base is set to minute.

M = time value

00: Time-out Disable
01: Time-out occurs after 1 minute
02: Time-out occurs after 2 minutes
03: Time-out occurs after 3 minutes
.
.
FFh: Time-out occurs after 255 minutes

This page is intentionally left blank.