

User Manual

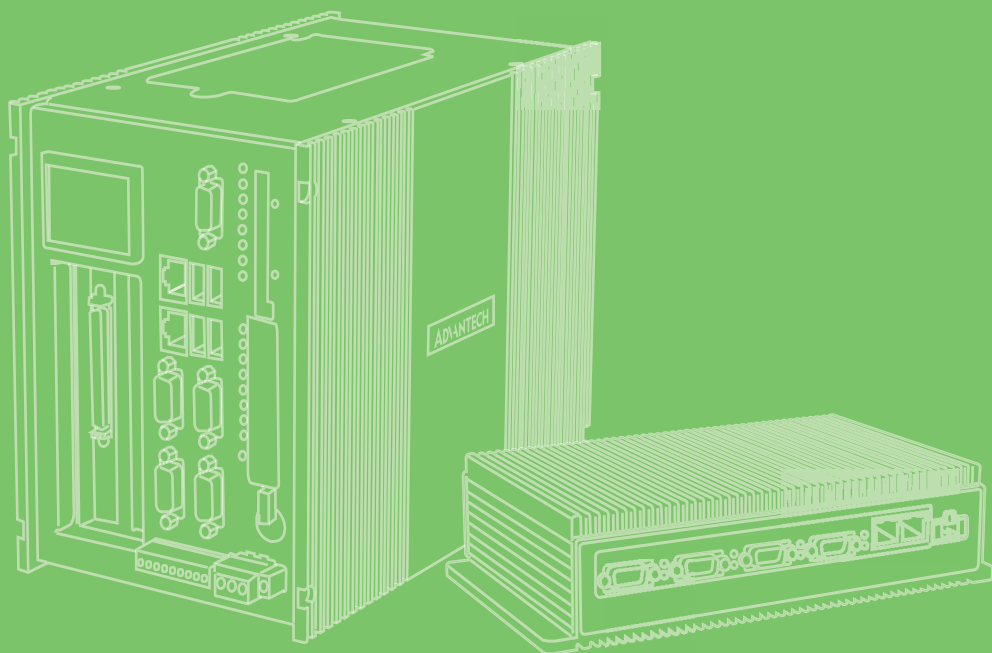

UNO-2272G

電腦

Intel® Atom™/Celeron® Palm-
Size Automation Computer with
1 x GbE, 2 x mPCIe, VGA/HDMI

ADVANTECH

Enabling an Intelligent Planet

BSMI RoHS 限用物質含有情況標示確認表

設備名稱：電腦 Equipment name		型號（型式）：UNO-2272G-J2AE（系列型號請參見次頁說明書） Type designation (Type)				
單元 Unit	限用物質及其化學符號 Restricted substances and its chemical symbols					
	鉛 Lead (Pb)	汞 Mercury (Hg)	鎘 Cadmium (Cd)	六價鉻 Hexavalent chromium (Cr ⁺⁶)	多溴聯苯 Polybrominated biphenyls (PBB)	多溴二苯醚 Polybrominated diphenyl ethers (PBDE)
電路板	—	○	○	○	○	○
內外殼 （外殼、內部 框架…等）	○	○	○	○	○	○
其它固定組件 （螺絲、夾 具、卡筍）	—	○	○	○	○	○
配件（線材）	○	○	○	○	○	○
記憶卡	—	○	○	○	○	○
備考 1. “超出 0.1 wt %” 及 “超出 0.01 wt %” 係指限用物質之百分比含量超出百分比含量基準值。 Note 1: “Exceeding 0.1 wt %” and “exceeding 0.01 wt %” indicate that the percentage content of the restricted substance exceeds the reference percentage value of presence condition.						
備考 2. “○” 係指該項限用物質之百分比含量未超出百分比含量基準值。 Note 2: “○” indicates that the percentage content of the restricted substance does not exceed the percentage of reference value of presence.						
備考 3. “—” 係指該項限用物質為排除項目。 Note 3: The “?” indicates that the restricted substance corresponds to the exemption.						

BSMI RoHS 限用物質含有情況標示確認表

設備名稱：電腦 Equipment name		型號（型式）： UNO-2272G（系列型號請參見次頁說明書） Type designation (Type)				
單元 Unit	限用物質及其化學符號 Restricted substances and its chemical symbols					
	鉛 Lead (Pb)	汞 Mercury (Hg)	鎘 Cadmium (Cd)	六價鉻 Hexavalent chromium (Cr ⁺⁶)	多溴聯苯 Polybrominated biphenyls (PBB)	多溴二苯醚 Polybrominated diphenyl ethers (PBDE)
電路板	—	○	○	○	○	○
內外殼 （外殼、內部 框架 … 等）	○	○	○	○	○	○
其它固定組件 （螺絲、夾 具、卡筍）	—	○	○	○	○	○
配件（線材）	○	○	○	○	○	○
記憶卡	—	○	○	○	○	○
備考 1. “超出 0.1 wt %” 及 “超出 0.01 wt %” 係指限用物質之百分比含量超出百分比含量基準值。 Note 1: “Exceeding 0.1 wt %” and “exceeding 0.01 wt %” indicate that the percentage content of the restricted substance exceeds the reference percentage value of presence condition.						
備考 2. “○” 係指該項限用物質之百分比含量未超出百分比含量基準值。 Note 2: “○” indicates that the percentage content of the restricted substance does not exceed the percentage of reference value of presence.						
備考 3. “—” 係指該項限用物質為排除項目。 Note 3: The “?” indicates that the restricted substance corresponds to the exemption.						

UNO-2272G
UNO-2272G-N2AE UNO-2272G-J2AE
UNO2272GN2A1401E-TUNO2272GJ2A1601E-T
UNO2272GN2A1402E-TUNO2272GJ2A1602E-T
UNO2272GN2A1403E-TUNO2272GJ2A1603E-T
UNO2272GN2A1404E-TUNO2272GJ2A1701E-T
UNO2272GN2A1405E-TUNO2272GJ2A1702E-T
UNO2272GN2A1501E-TUNO2272GJ2A1703E-T
UNO2272GN2A1502E-TUNO2272GJ2A1704E-T
UNO2272GN2A1503E-TUNO2272GJ2A1705E-T
UNO2272GN2A1601E-TUNO2272GJ2A1706E-T
UNO2272GN2A1602E-TUNO2272GJ2A1707E-T
UNO2272GN2A1701E-TUNO2272GJ2A1708E-T
UNO2272GN2A1702E-TUNO2272GJ2A1709E-T
UNO2272GN2A1703E-TUNO2272GJ2A1710E-T
UNO2272GN2A1704E-TUNO2272GJ2A1801E-T
UNO2272GN2A1705E-TUNO2272GJ2A1802E-T
UNO2272GN2A1706E-TUNO2272GJ2A1803E-T
UNO2272GN2A1707E-TUNO2272GJ2A1804E-T
UNO2272GN2A1708E-TUNO2272GJ2A1805E-T
UNO2272GN2A1709E-TUNO2272GJ2A1806E-T
UNO2272GN2A1710E-TUNO2272GJ2A1807E-T
UNO2272GN2A1801E-TUNO2272GJ2A1808E-T
UNO2272GN2A1802E-TUNO2272GJ2A1809E-T
UNO2272GN2A1803E-TUNO2272GJ2A1810E-T
UNO2272GN2A1804E-TUNO2272GJ2A1901E-T
UNO2272GN2A1805E-TUNO2272GJ2A1902E-T
UNO2272GN2A1806E-TUNO2272GJ2A1903E-T
UNO2272GN2A1807E-TUNO2272GJ2A1904E-T
UNO2272GN2A1808E-TUNO2272GJ2A1905E-T
UNO2272GN2A1809E-TUNO2272GJ2A1906E-T
UNO2272GN2A1810E-TUNO2272GJ2A1907E-T
UNO2272GN2A1901E-TUNO2272GJ2A1908E-T
UNO2272GN2A1902E-TUNO2272GJ2A1909E-T
UNO2272GN2A1903E-TUNO2272GJ2A1910E-T
UNO2272GN2A1904E-TUNO2272GJ2A2001E-T
UNO2272GN2A1905E-TUNO2272GJ2A2002E-T
UNO2272GN2A1906E-TUNO2272GJ2A2003E-T
UNO2272GN2A1907E-TUNO2272GJ2A2004E-T
UNO2272GN2A1908E-TUNO2272GJ2A2005E-T
UNO2272GN2A1909E-TUNO2272GJ2A2006E-T
UNO2272GN2A1910E-TUNO2272GJ2A2007E-T
UNO2272GJ2A2008E-T
UNO2272GJ2A2009E-T
UNO2272GJ2A2010E-T

Copyright

The documentation and the software included with this product are copyrighted 2018 by Advantech Co., Ltd. All rights are reserved. Advantech Co., Ltd. reserves the right to make improvements in the products described in this manual at any time without notice. No part of this manual may be reproduced, copied, translated or transmitted in any form or by any means without the prior written permission of Advantech Co., Ltd. Information provided in this manual is intended to be accurate and reliable. However, Advantech Co., Ltd. assumes no responsibility for its use, nor for any infringements of the rights of third parties, which may result from its use.

Acknowledgements

IBM, PC/AT, PS/2 and VGA are trademarks of International Business Machines Corporation.

Intel®, Core™ and Atom™ are the trademarks of Intel Corporation

Microsoft Windows and MS-DOS are registered trademarks of Microsoft Corp.

All other product names or trademarks are properties of their respective owners.

Support

For more information on this and other Advantech products, please visit our websites at: <http://www.advantech.com>

For technical support and service, please visit our support website at:
<http://support.advantech.com/>

Product Warranty (2 years)

Advantech warrants to you, the original purchaser, that each of its products will be free from defects in materials and workmanship for two years from the date of purchase.

This warranty does not apply to any products which have been repaired or altered by persons other than repair personnel authorized by Advantech, or which have been subject to misuse, abuse, accident or improper installation. Advantech assumes no liability under the terms of this warranty as a consequence of such events.

Because of Advantech's high quality-control standards and rigorous testing, most of our customers never need to use our repair service. If an Advantech product is defective, it will be repaired or replaced at no charge during the warranty period. For out-of-warranty repairs, you will be billed according to the cost of replacement materials, service time and freight. Please consult your dealer for more details.

If you think you have a defective product, follow these steps:

1. Collect all the information about the problem encountered. (For example, CPU speed, Advantech products used, other hardware and software used, etc.) Note anything abnormal and list any onscreen messages you get when the problem occurs.
2. Call your dealer and describe the problem. Please have your manual, product, and any helpful information readily available.
3. If your product is diagnosed as defective, obtain an RMA (return merchandise authorization) number from your dealer. This allows us to process your return more quickly.
4. Carefully pack the defective product, a fully-completed Repair and Replacement Order Card and a photocopy proof of purchase date (such as your sales receipt) in a shippable container. A product returned without proof of the purchase date is not eligible for warranty service.
5. Write the RMA number visibly on the outside of the package and ship it prepaid to your dealer.

Declaration of Conformity

CE

This product has passed the CE test for environmental specifications when shielded cables are used for external wiring. We recommend the use of shielded cables. This kind of cable is available from Advantech. Please contact your local supplier for ordering information.

FCC Class A

Note: This equipment has been tested and found to comply with the limits for a Class A digital device, pursuant to part 15 of the FCC Rules. These limits are designed to provide reasonable protection against harmful interference when the equipment is operated in a commercial environment. This equipment generates, uses, and can radiate radio frequency energy and, if not installed and used in accordance with the instruction manual, may cause harmful interference to radio communications. Operation of this equipment in a residential area is likely to cause harmful interference in which case the user will be required to correct the interference at his own expense.

Technical Support and Assistance

1. Visit the Advantech web site at www.advantech.com/support where you can find the latest information about the product.
2. Contact your distributor, sales representative, or Advantech's customer service center for technical support if you need additional assistance. Please have the following information ready before you call:
 - Product name and serial number
 - Description of your peripheral attachments
 - Description of your software (operating system, version, application software, etc.)
 - A complete description of the problem
 - The exact wording of any error messages

Safety Precaution - Static Electricity

Follow these simple precautions to protect yourself from harm and the products from damage.

- To avoid electrical shock, always disconnect the power from your PC chassis before working on it. Don't touch any components on the CPU card or other cards while the PC is on.
- Disconnect power before making any configuration changes. The sudden rush of power as you connect a jumper or install a card may damage sensitive electronic components.

Safety Instructions

1. Read these safety instructions carefully.
2. Keep this User Manual for later reference.
3. Disconnect this equipment from any AC outlet before cleaning. Use a damp cloth. Do not use liquid or spray detergents for cleaning.
4. For plug-in equipment, the power outlet socket must be located near the equipment and must be easily accessible.
5. Keep this equipment away from humidity.
6. Put this equipment on a reliable surface during installation. Dropping it or letting it fall may cause damage.
7. The openings on the enclosure are for air convection. Protect the equipment from overheating. **DO NOT COVER THE OPENINGS.**
8. Make sure the voltage of the power source is correct before connecting the equipment to the power outlet.
9. Position the power cord so that people cannot step on it. Do not place anything over the power cord.
10. All cautions and warnings on the equipment should be noted.
11. If the equipment is not used for a long time, disconnect it from the power source to avoid damage by transient overvoltage.
12. Never pour any liquid into an opening. This may cause fire or electrical shock.
13. Never open the equipment. For safety reasons, the equipment should be opened only by qualified service personnel.
14. If one of the following situations arises, get the equipment checked by service personnel:
 - The power cord or plug is damaged.
 - Liquid has penetrated into the equipment.
 - The equipment has been exposed to moisture.
 - The equipment does not work well, or you cannot get it to work according to the user's manual.
 - The equipment has been dropped and damaged.
 - The equipment has obvious signs of breakage.
15. **DO NOT LEAVE THIS EQUIPMENT IN AN ENVIRONMENT WHERE THE STORAGE TEMPERATURE MAY GO BELOW -20°C (-4° F) OR ABOVE 60°C (140°F) for UNO-2272G-N2AE and BELOW 0°C (32°F) OR ABOVE 50°C (122°F) for UNO-2272G-J2AE. THIS COULD DAMAGE THE EQUIPMENT. THE EQUIPMENT SHOULD BE IN A CONTROLLED ENVIRONMENT.**
16. **CAUTION: DANGER OF EXPLOSION IF BATTERY IS INCORRECTLY REPLACED. REPLACE ONLY WITH THE SAME OR EQUIVALENT TYPE RECOMMENDED BY THE MANUFACTURER, DISCARD USED BATTERIES ACCORDING TO THE MANUFACTURER'S INSTRUCTIONS.**
17. **ATTENTION: Danger d'explosion si la batterie est mal REMPLACÉ. REMPLACER UNIQUEMENT PAR LE MEME TYPE OU EQUIVALENT RECOMMANDÉ PAR LE FABRICANT, jeter les piles usagées SELON LES INSTRUCTIONS DU FABRICANT.**
18. The sound pressure level at the operator's position according to IEC 704-1:1982 is no more than 70 dB (A).

DISCLAIMER: This set of instructions is given according to IEC 704-1. Advantech disclaims all responsibility for the accuracy of any statements contained herein.

安全指示

1. 请仔细阅读此安全操作说明。
2. 请妥善保存此用户手册供日后参考。
3. 用湿抹布清洗设备前，请从插座拔下电源线。请不要使用液体或去污喷雾剂清洗设备。
4. 对于使用电源线的设备，设备周围必须有容易接触到的电源插座。
5. 请不要在潮湿环境中使用设备。
6. 请在安装前确保设备放置在可靠的平面上，意外跌落可能会导致设备损坏。
7. 设备外壳的开口是用于空气对流，从而防止设备过热。**请不要覆盖这些开口。**
8. 当您连接设备到电源插座上前，请确认电源插座的电压是否符合要求。
9. 请将电源线布置在人们不易绊到的位置，并不要在电源线上覆盖任何杂物。
10. 请注意设备上的所有警告标识。
11. 如果长时间不使用设备，请将其同电源插座断开，避免设备被超标的电压波动损坏。
12. 请不要让任何液体流入通风口，以免引起火灾或者短路。
13. 请不要自行打开设备。为了确保您的安全，请由经过认证的工程师来打开设备。
14. 如遇下列情况，请由专业人员来维修：
 - 电源线或者插头损坏；
 - 设备内部有液体流入；
 - 设备曾暴露在过于潮湿的环境中使用；
 - 设备无法正常工作，或您无法通过用户手册来使其正常工作；
 - 设备跌落或者损坏；
 - 设备有明显的外观破损。
15. 请不要把设备放置在超出我们建议的温度范围的环境，即 UNO-2272G-N2AE 不要低于 -20°C (-4°F) 或高于 60°C (140°F)；UNO-2272G-J2AE 不要低于 0°C (-32°F) 或高于 50°C (122°F)，否则可能会损坏设备。
16. **注意：**计算机配置了由电池供电的实时时钟电路，如果电池放置不正确，将有爆炸的危险。因此，只可以使用制造商推荐的同一种或者同等型号的电池进行替换。请按照制造商的指示处理旧电池。
17. 根据 IEC 704-1:1982 的规定，操作员所在位置的声压级不可高于 70dB(A)。
18. 限制区域：请勿将设备安装于限制区域使用。

免责声明：该安全指示符合 IEC 704-1 的要求。研华公司对其内容的准确性不承担任何法律责任。

Contents

Chapter 1	Overview	1
1.1	Introduction	2
1.2	Safety Precautions	2
1.3	Accessories	3
1.4	Specifications	3
Chapter 2	Hardware Functionality	5
2.1	Introduction	6
	Figure 2.1 Front Panel of UNO-2272G-N2AE	6
	Figure 2.2 Rear Panel of UNO-2272G-N2AE	6
	Figure 2.3 Front Panel of UNO-2272G-J2AE	6
	Figure 2.4 Rear Panel of UNO-2272G-J2AE	6
2.2	UNO-2272G Interface	7
	2.2.1 COM Port Interface (COM 1)	7
2.3	LAN: Ethernet Connector	7
2.4	Power Connector	7
2.5	USB Connector	7
2.6	RTC Battery Specification	7
2.7	Power Button/Power Management	8
2.8	Reset Button	8
2.9	HD Audio	8
2.10	PCI Express Mini Card Socket	8
Chapter 3	Initial Setup	11
3.1	Inserting a mSATA	12
3.2	Chassis Grounding	12
	Figure 3.1 Chassis Grounding Connection	12
3.3	Connecting Power	12
Appendix A	Syst. Settings & Pin Assignments ...	13
A.1	System I/O Address and Interrupt Assignment	14
	Table A.1: Interrupt Assignments	14
A.2	Board Connectors and Jumpers	15
	Figure A.1 Connector & Jumper Locations for UNO-2272G-N2AE(front)	15
	Table A.2: Connectors and Jumpers	15
	Figure A.2 Connector & Jumper Locations for UNO-2272G-J2AE(front)	15
	Table A.3: Connectors and Jumpers	15
A.3	RS-232 Standard Serial Port	16
	Table A.4: RS-232 Serial Port Pin Assignments	16
A.4	Power Connector (PWR)	16
	Table A.5: Power Connector Pin Assignments	16
A.5	USB Connector	17
	Table A.6: USB 2.0 Connector Pin Assignments	17
	Table A.7: USB 3.0 Connector Pin Assignments	17
A.6	HDMI Display Connector	18
	Table A.8: HDMI Display Connector	18

Chapter 1

Overview

This chapter provides an overview of UNO-2272G specifications.

Sections include:

- Introduction
- Safety precautions
- Accessories

1.1 Introduction

The UNO-2272G is an embedded Application Ready Platform (ARP) that can shorten development time while offering a wide array of networking interfaces capable of fulfilling the extensive needs of different projects. UNO-2272G includes Intel's latest Atom/Celeron technology and provides rich interfaces, including up to 1 serial port, 1 x GbE LAN, 3 x USB ports and Audio. The UNO-2272G supports one VGA or HDMI display depending on the model and also Advantech's latest iDoor technology.

The UNO-2272G can operate in a wide temperature range (from -20 to 60°C or -10 to 50°C depending on model). The UNO-2272G also uses Intel Atom/Celeron CPUs with great computing power and up to 2G DDR3 RAM built-in for heavy programs.

The UNO-2272G provides great expansion, including 2 x Mini-PCIe and SIM card support. With these expansions, UNO-2272G has great expandability from Wi-Fi, 3G, I/O expansion and industrial protocols with iDoor technology.

With multiple OS and driver support, such as Windows 7, WES7, and embedded Linux, users can integrate applications easily in an application ready platform that can provide versatile functions to fulfill diverse requirements.

1.2 Safety Precautions

The following sections tell how to make each connection. In most cases, you will simply need to connect a standard cable.

Warning! *Always disconnect the power cord from your chassis whenever you are working on it. Do not connect while the power is on. A sudden rush of power can damage sensitive electronic components. Only experienced electronics personnel should open the chassis.*



Warning! *Toujours à la terre pour éliminer toute charge d'électricité statique avant toucher UNO-2272G. Appareils électroniques modernes sont très sensibles à charges d'électricité statique. Utilisez un bracelet antistatique à tout moment. Placez tous composants électroniques sur une surface antistatique ou dans un statique-sac blindé.*



Caution! *Always ground yourself to remove any static electric charge before touching UNO-2272G. Modern electronic devices are very sensitive to static electric charges. Use a grounding wrist strap at all times. Place all electronic components on a static-dissipative surface or in a static-shielded bag.*



Caution! *Toujours débrancher le cordon d'alimentation de votre boîtier lorsque vous êtes travailler. Ne branchez pas lorsque l'appareil est allumé. Un afflux soudain de puissance peut endommager les composants électroniques sensibles. Seulement connu personnel de l'électronique devraient ouvrir le châssis.*



1.3 Accessories

Please refer below for the accessory list:

- Pin connector for power wiring (Advantech P/N: 1652002205)
- mPCIe screws (Advantech P/N: 1935020300)
- 4 PCS jumper (Advantech P/N: 1653302122)
- 4 Mounting Screws (Advantech P/N:1935040620)
- Driver DVD
- Warranty card

If anything is missing or damaged, contact your distributor or sales representative immediately.

1.4 Specifications

- Operating Temperature: -20 to 60°C(UNO-2272G-N2AE)
- Operating Temperature: -10 to 55°C(UNO-2272G-J2AE)
- Power Requirements: 24VDC + 20%
- Power Consumption: 12W (Typical), 20W (Max)
- System Hardware Specification
- CPU: Intel Atom Dual Core N2800 1.86GHz(UNO-2272G-N2AE)
- Intel Celeron Quad Core J1900 2GHz(UNO-2272G-J2AE)
- Memory:
 - UNO-2272G-N2AE Built in 2G DDR3 1600MHz RAM
 - UNO-2272G-J2AE Built in 2G DDR3L 1600MHz RAM
- Graphic Engine: Intel HD Graphic
- Ethernet:
 - Intel 82583V GbE, 802.10av, IEEE1588/802.1AS, 803.3az for UNO-2272GN2AE
 - Intel i210 GbE, 802.10av, IEEE1588/802.1AS, 803.3az for UNO-2272GJ2AE
- Storage:
 - UNO-2272G-N2AE use 1 x Full mSATA
 - UNO-2272G-J2AE use 1 x half mSATA
- Expansion:
 - 1x Full-size mPCIe slot, 1x Half-size mPCIe slot, mPCIe2.0(UNO-2272G-N2AE)
 - 2x Full-size mPCIe slot, mPCIe2.0(UNO-2272G-J2AE)
- Display:
 - 1 x VGA, support 1920 x 1200 @60Hz 24bpp for UNO-2272G-N2AE
 - 1 x HDMI, support 1920 x 1080 @60Hz 24bpp for UNO-2272G-NJAE

Chapter 2

Hardware Functionality

This chapter shows how to setup the UNO-2272G's hardware functions, including connecting peripherals, setting switches and indicators.

Sections include:

- Peripherals
- RS-232 Interface
- LAN / Ethernet Connector
- Power Connector
- Audio Connector
- USB Connector
- HDMI Display Connector
- Reset Button

2.1 Introduction

The following figures show the connectors on UNO-2272G. The following sections give you information about each peripheral.

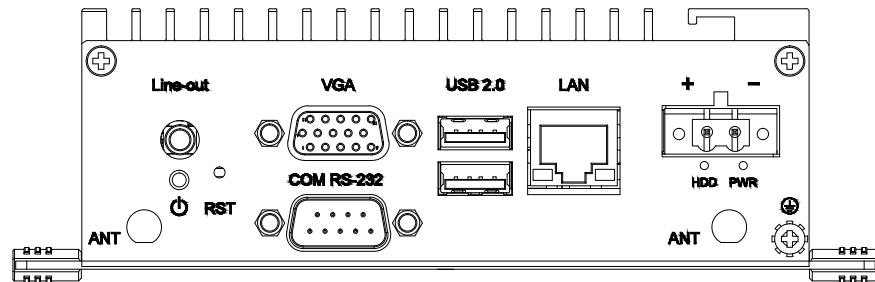

Figure 2.1 Front Panel of UNO-2272G-N2AE

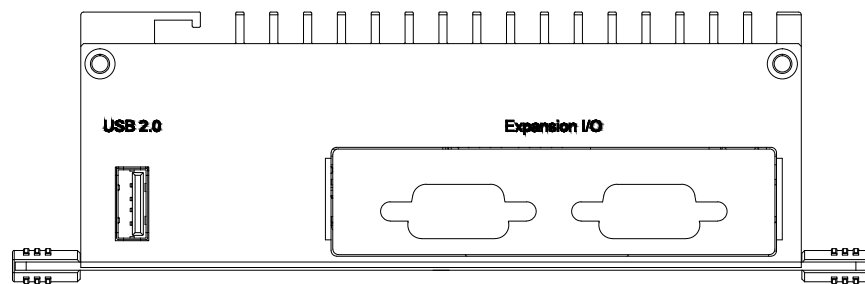

Figure 2.2 Rear Panel of UNO-2272G-N2AE

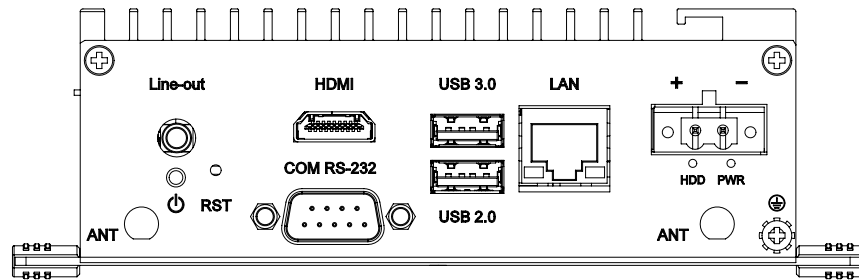

Figure 2.3 Front Panel of UNO-2272G-J2AE

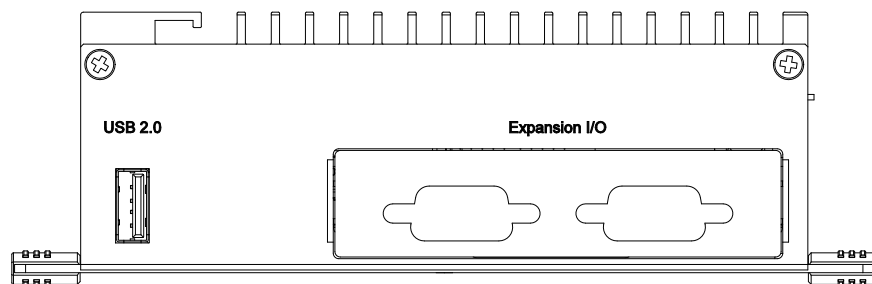

Figure 2.4 Rear Panel of UNO-2272G-J2AE

2.2 UNO-2272G Interface

UNO-2272G offers one standard RS-232 serial communication interface port: COM1. The IRQ and I/O address range of COM1 is listed below:

COM1: 3F8h, IRQ4

The setting can be adjusted in the BIOS page. The driver will be installed automatically during OS installation

2.2.1 COM Port Interface (COM 1)

For UNO-2272G-N2AE, 1 x RS-232, DB9, 50~115.2kbps.

For UNO-2272G-J2AE, 1 x RS-232 (RS-422/485 by BIOS option), DB9, 50 ~115.2kbps

Refer to Appendix A.3 for their pin assignments.

2.3 LAN: Ethernet Connector

UNO-2272Gs are equipped with one Gigabit LAN controller.

For the UNO-2272G-N2AE, the controller chip used is an Intel 82583V Ethernet controller that is fully compliant with IEEE 802.3u 10/100/1000 Base-T.

For the UNO-2272G-J2AE, the controller chip used is an Intel i210 Ethernet controller that is fully compliant with IEEE 802.3u 10/100/1000 Base-T.

The Ethernet port is a standard RJ-45 jack, and LED indicators are on the front to show its Link (Green LED) and Active (Yellow LED) status.

2.4 Power Connector

The UNO-2272G comes with a Phoenix connector that carries 24 V_{DC} external power input and features reversed wiring protection. Therefore, it will not cause any damage to the system by reversed wiring of the ground line and power line. Please refer to Appendix A.4

2.5 USB Connector

The USB interface supports Plug and Play, which enables you to connect or disconnect a device whenever you want without turning off the computer. The UNO-2272G provides three USB connectors, which gives complete Plug & Play and hot swapping for up to 127 external devices. The USB interface can be disabled in the system BIOS.

For the UNO-2272G-N2AE, there are three [3] USB ports which comply with USB EHCI, Rev. 2.0 compliant.

For the UNO-2272G-J2AE, there are three [3] USB ports, two [2] ports comply with USB EHCI, Rev. 2.0 compliant and one [1] port complies with USB EHCI, Rev. 3.0 compliant.

Refer to Appendix A.5 for its pin assignments.

2.6 RTC Battery Specification

The UNO-2272G has an RTC Battery to ensure the setting in BIOS and system clock can be kept, even when power is disconnected for a short time.

- **Type:** CR2032

- **Output Voltage:** 3 V_{DC}

2.7 Power Button/Power Management

Press the "PWR" button to power on or power off the UNO-2272G (ATX type). The UNO-2272G supports the ACPI (Advanced Configuration and Power Interface). Besides power on/off, it support multiple suspend modes, such as Power on Suspend (S1), Suspend to RAM (S3), Suspend to Disk (S4). In S3 and S4 suspend mode, the power consumption can be less than 2W, which meets the criteria of Energy Star.

2.8 Reset Button

Press the "Reset" button to activate the hardware reset function.

2.9 HD Audio

The UNO-2272G provides 1 phone jack connector for 7.1 channel output. Configure the function through the provided software utility.

The UNO-2272G-N2AE is equipped with the ALC892-GR High Definition Audio Codec.

The UNO-2272G-J2AE is equipped with the ALC888S-VD2-GR High Definition Audio Codec.

2.10 PCI Express Mini Card Socket

The UNO-2272G-N2AE supports two sockets for one full size and one half size PCI Express mini cards. The CN6 slot is the default defined ONLY for mSATA storage. The second interface (CN8) is the half size PCI Express mini card. The third (CN10) interface is mainly targeted at supporting iDoor technology/modules for diverse applications such as isolated COM port, Profibus, WLAN GPRS, 3G, mRAM and iDoor Module. Users can install the card easily using the optional kit.

Note! *An additional SIM card slot is disabled. Please note you still require 3G Mini-PCIe built-in SIM card slot module installed to be able to use 3G functions. (For model produced before June 2015)*



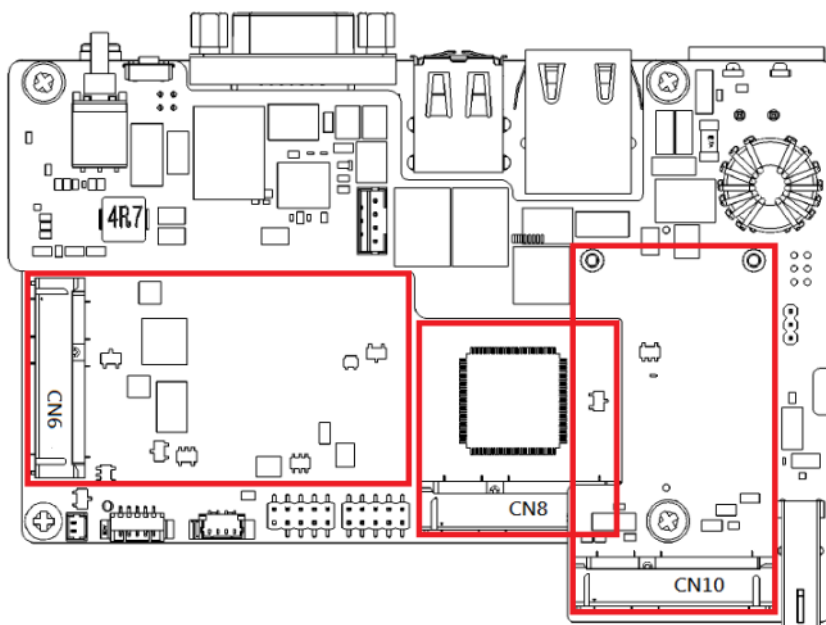

The UNO-2272G-J2AE supports two sockets for full size PCI Express mini cards. The CN15 slot is the default defined ONLY for half size mSATA storage.

The second interface (CN16) and third interface (CN10) are full size PCI Express mini cards. These two interfaces are mainly targeted at supporting iDoor technology/modules for diverse applications such as isolated COM port, Profibus, WLAN GPRS, 3G, mRAM and iDoor Module. Users can install the card easily using the optional kit.

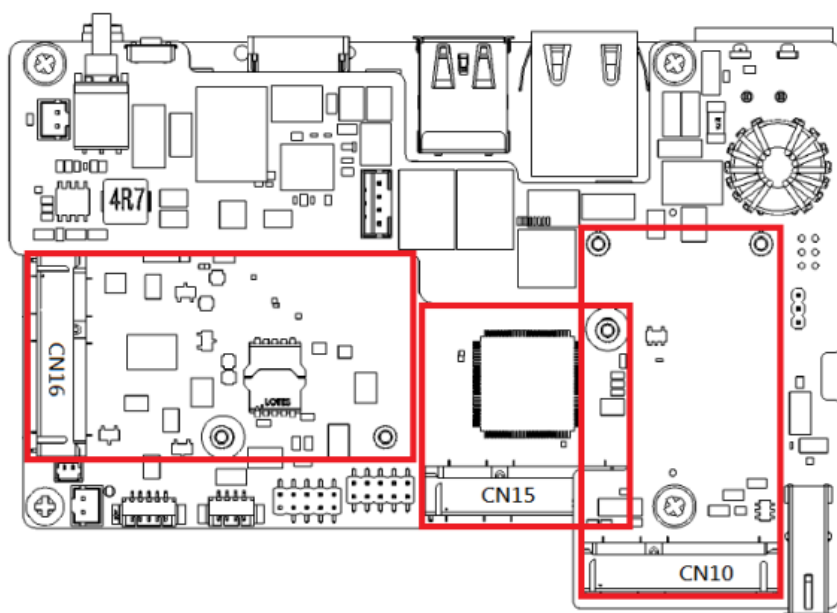

Chapter 3

Initial Setup

This chapter introduces how to initialize the UNO-2272G.

Sections include:

- Inserting a mSATA
- Chassis Grounding
- Connecting Power
- Installing a Wireless LAN Card and Antenna

3.1 Inserting a mSATA

1. Remove the power cord.
2. Unscrew the six screws in the bottom cover.
3. Plug a mSATA card with your OS and application program into the first mPCIe slot CN6 for UNO-2272G-N2AE or CN15 for UNO-2272G-J2AE
4. Screw the two screws on the board to fix mSATA.
5. Screw back the bottom cover.

3.2 Chassis Grounding

UNO-2272G provides good EMI protection and a stable grounding base. There is an easy-to-connect chassis grounding point to use.

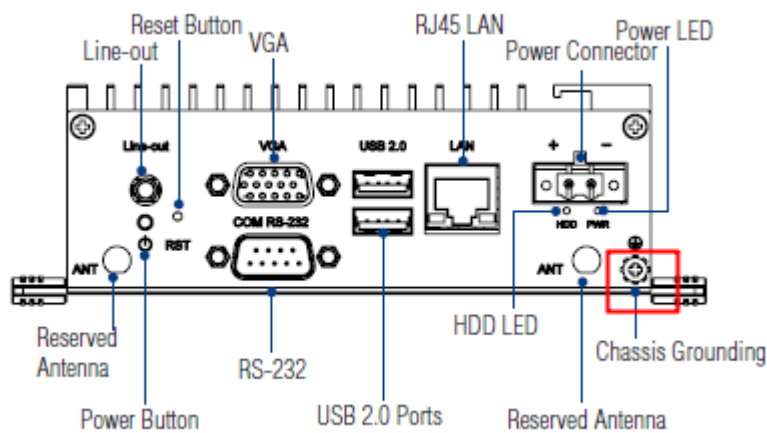

Figure 3.1 Chassis Grounding Connection

3.3 Connecting Power

This product is intended to be supplied by a Listed DC Power Source, rated 24Vdc, 1A minimum and Tma 60 degree C, if further assistance is required, please contact Advantech for more information.

Appendix **A**

Syst. Settings & Pin
Assignments

A.1 System I/O Address and Interrupt Assignment

Table A.1: Interrupt Assignments

Interrupt No.	Interrupt Source
NMI	Parity Error Detected
IRQ0	System Timer
IRQ1	Standard 101/102-Key or Microsoft Natural PS/2Keyboard
IRQ2	Interrupt from Controller 2 (Cascade)
IRQ3	Communications Port (COM2)
IRQ4	Communications Port (COM1)
IRQ6	Available
IRQ8	System CMOS/Real-Time Clock
IRQ9	Microsoft ACPI-Compliant System
IRQ12	PS/2 Compatible Mouse
IRQ13	Numeric Data Processor
IRQ14	Reserved
IRQ15	Reserved

A.2 Board Connectors and Jumpers

There are several connectors and jumpers on the UNO-2272G board. The following sections tell you how to configure the UNO-2272G hardware setting.

Figure A.1 shows the locations of UNO-2272G's connectors and jumpers.

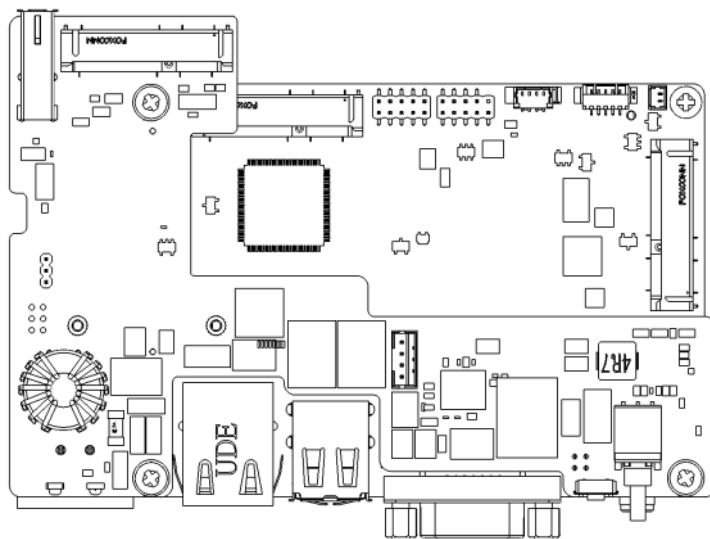

Figure A.1 Connector & Jumper Locations for UNO-2272G-N2AE(front)

Table A.2: Connectors and Jumpers

Label	Function
CN8 CN10	PCI Express Mini Card Socket
CN6	mSATA

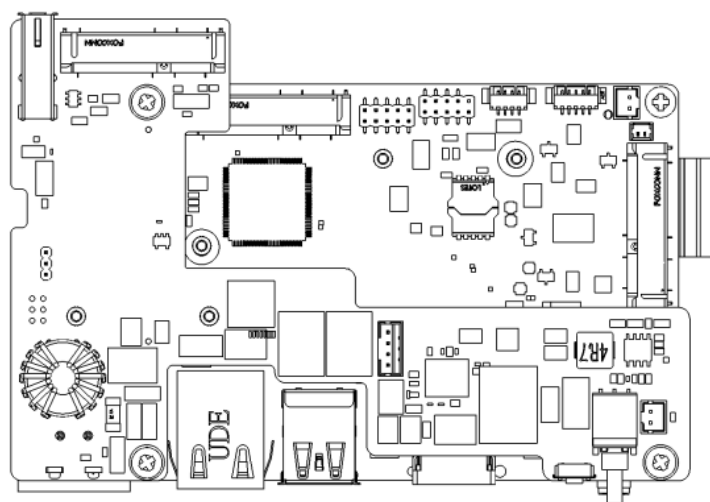

Figure A.2 Connector & Jumper Locations for UNO-2272G-J2AE(front)

Table A.3: Connectors and Jumpers

Label	Function
CN16 CN10	PCI Express Mini Card Socket
CN15	mSATA

A.3 RS-232 Standard Serial Port

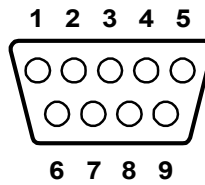

Table A.4: RS-232 Serial Port Pin Assignments

Pin	Pin Name
1	DCD
2	RxD
3	TxD
4	DTR
5	GND
6	DSR
7	RTS
8	CTS
9	RI

A.4 Power Connector (PWR)

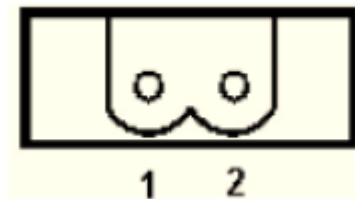

Table A.5: Power Connector Pin Assignments

Pin	Pin Name
1	V+ (24VDC)
2	V-

A.5 USB Connector

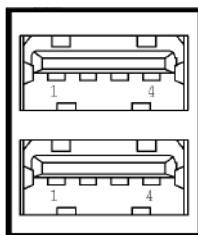

Table A.6: USB 2.0 Connector Pin Assignments

Pin	Signal Name	Cable Color
1	VCC	Red
2	DATA-	White
3	DATA+	Green
4	GND	Black

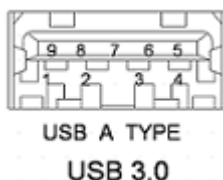

Table A.7: USB 3.0 Connector Pin Assignments

Pin	Signal Name	Description
1	VBUS	Power
2	D-	USB2.0 Differential Pair
3	D+	
4	GND	Ground for Power Return
5	StdA_SSRX-	SuperSpeed Receiver Differential Pair
6	StdA_SSRX+	
7	GND_DRIAN	Ground for Signal Return
8	StdA_SSTX-	SuperSpeed Transmitter Differential Pair
9	StdA_SSTX+	

A.6 HDMI Display Connector

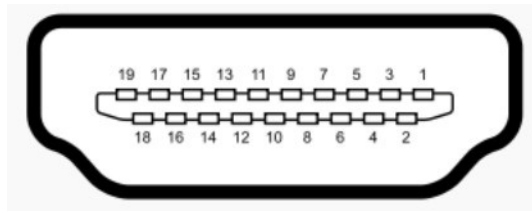

Table A.8: HDMI Display Connector

Pin	Signal	Pin	Signal
1	TMDS Data2+	2	TMDS Data2 Shield
3	TMDS Data2-	4	TMDS Data1+
5	TMDS Data1 Shield	6	TMDS Data1-
7	TMDS Data0+	8	TMDS Data0 Shield
9	TMDS Data0-	10	TMDS Clock+
11	TMDS Clock Shield	12	TMDS Clock-
13	CEC	14	Reserved
15	SCL	16	SDA
17	DDC/CEC/HEC Ground	18	+5 V Power (max 50 mA)
19	Hot Plug Detect		

www.advantech.com

Please verify specifications before quoting. This guide is intended for reference purposes only.

All product specifications are subject to change without notice.

No part of this publication may be reproduced in any form or by any means, electronic, photocopying, recording or otherwise, without prior written permission of the publisher.

All brand and product names are trademarks or registered trademarks of their respective companies.

© Advantech Co., Ltd. 2018