



User Manual

SOM-6897

COM Express Compact Module

ADVANTECH

Enabling an Intelligent Planet

Copyright

The documentation and the software included with this product are copyrighted 2018 by Advantech Co., Ltd. All rights are reserved. Advantech Co., Ltd. reserves the right to make improvements in the products described in this manual at any time without notice. No part of this manual may be reproduced, copied, translated or transmitted in any form or by any means without the prior written permission of Advantech Co., Ltd. Information provided in this manual is intended to be accurate and reliable. However, Advantech Co., Ltd. assumes no responsibility for its use, nor for any infringements of the rights of third parties, which may result from its use.

Acknowledgements

Intel is a trademark of Intel Corporation.

Microsoft Windows and MS-DOS are registered trademarks of Microsoft Corp.

All other product names or trademarks are properties of their respective owners.

Product Warranty (2 years)

Advantech warrants to you, the original purchaser, that each of its products will be free from defects in materials and workmanship for two years from the date of purchase.

This warranty does not apply to any products which have been repaired or altered by persons other than repair personnel authorized by Advantech, or which have been subject to misuse, abuse, accident or improper installation. Advantech assumes no liability under the terms of this warranty as a consequence of such events.

Because of Advantech's high quality-control standards and rigorous testing, most of our customers never need to use our repair service. If an Advantech product is defective, it will be repaired or replaced at no charge during the warranty period. For out-of-warranty repairs, you will be billed according to the cost of replacement materials, service time and freight. Please consult your dealer for more details.

If you think you have a defective product, follow these steps:

1. Collect all the information about the problem encountered. (For example, CPU speed, Advantech products used, other hardware and software used, etc.) Note anything abnormal and list any onscreen messages you get when the problem occurs.
2. Call your dealer and describe the problem. Please have your manual, product, and any helpful information readily available.
3. If your product is diagnosed as defective, obtain an RMA (return merchandise authorization) number from your dealer. This allows us to process your return more quickly.
4. Carefully pack the defective product, a fully-completed Repair and Replacement Order Card and a photocopy proof of purchase date (such as your sales receipt) in a shippable container. A product returned without proof of the purchase date is not eligible for warranty service.
5. Write the RMA number visibly on the outside of the package and ship it prepaid to your dealer.

Declaration of Conformity

CE

This product has passed the CE test for environmental specifications. Test conditions for passing included the equipment being operated within an industrial enclosure. In order to protect the product from being damaged by ESD (Electrostatic Discharge) and EMI leakage, we strongly recommend the use of CE-compliant industrial enclosure products.

FCC Class B

Note: This equipment has been tested and found to comply with the limits for a Class B digital device, pursuant to part 15 of the FCC Rules. These limits are designed to provide reasonable protection against harmful interference in a residential installation. This equipment generates, uses and can radiate radio frequency energy and, if not installed and used in accordance with the instructions, may cause harmful interference to radio communications. However, there is no guarantee that interference will not occur in a particular installation. If this equipment does cause harmful interference to radio or television reception, which can be determined by turning the equipment off and on, the user is encouraged to try to correct the interference by one or more of the following measures:

- Reorient or relocate the receiving antenna.
- Increase the separation between the equipment and receiver.
- Connect the equipment into an outlet on a circuit different from that to which the receiver is connected.
- Consult the dealer or an experienced radio/TV technician for help.

FM

This equipment has passed the FM certification. According to the National Fire Protection Association, work sites are classified into different classes, divisions and groups, based on hazard considerations. This equipment is compliant with the specifications of Class I, Division 2, Groups A, B, C and D indoor hazards.

Technical Support and Assistance

1. Visit the Advantech website at <http://support.advantech.com> where you can find the latest information about the product.
2. Contact your distributor, sales representative, or Advantech's customer service center for technical support if you need additional assistance. Please have the following information ready before you call:
 - Product name and serial number
 - Description of your peripheral attachments
 - Description of your software (operating system, version, application software, etc.)
 - A complete description of the problem
 - The exact wording of any error messages

Warnings, Cautions and Notes

Warning! Warnings indicate conditions, which if not observed, can cause personal injury!



Caution! Cautions are included to help you avoid damaging hardware or losing data.



Note! Notes provide optional additional information.



Document Feedback

To assist us in making improvements to this manual, we would welcome comments and constructive criticism. Please send all such - in writing to: support@advantech.com

Packing List

Before setting up the system, check that the items listed below are included and in good condition. If any item does not accord with the table, please contact your dealer immediately.

- SOM-6897 CPU module
- 1 x Heatsreader (1960073722N011)

Safety Instructions

1. Read these safety instructions carefully.
2. Keep this User Manual for later reference.
3. Disconnect this equipment from any AC outlet before cleaning. Use a damp cloth. Do not use liquid or spray detergents for cleaning.
4. For plug-in equipment, the power outlet socket must be located near the equipment and must be easily accessible.
5. Keep this equipment away from humidity.
6. Put this equipment on a reliable surface during installation. Dropping it or letting it fall may cause damage.
7. The openings on the enclosure are for air convection. Protect the equipment from overheating. **DO NOT COVER THE OPENINGS.**
8. Make sure the voltage of the power source is correct before connecting the equipment to the power outlet.
9. Position the power cord so that people cannot step on it. Do not place anything over the power cord.
10. All cautions and warnings on the equipment should be noted.
11. If the equipment is not used for a long time, disconnect it from the power source to avoid damage by transient overvoltage.
12. Never pour any liquid into an opening. This may cause fire or electrical shock.
13. Never open the equipment. For safety reasons, the equipment should be opened only by qualified service personnel.
14. If one of the following situations arises, get the equipment checked by service personnel:
 - The power cord or plug is damaged.
 - Liquid has penetrated into the equipment.
 - The equipment has been exposed to moisture.
 - The equipment does not work well, or you cannot get it to work according to the user's manual.
 - The equipment has been dropped and damaged.
 - The equipment has obvious signs of breakage.
15. **DO NOT LEAVE THIS EQUIPMENT IN AN ENVIRONMENT WHERE THE STORAGE TEMPERATURE MAY GO BELOW -20° C (-4° F) OR ABOVE 60° C (140° F). THIS COULD DAMAGE THE EQUIPMENT. THE EQUIPMENT SHOULD BE IN A CONTROLLED ENVIRONMENT.**
16. **CAUTION: DANGER OF EXPLOSION IF BATTERY IS INCORRECTLY REPLACED. REPLACE ONLY WITH THE SAME OR EQUIVALENT TYPE RECOMMENDED BY THE MANUFACTURER, DISCARD USED BATTERIES ACCORDING TO THE MANUFACTURER'S INSTRUCTIONS.**

The sound pressure level at the operator's position according to IEC 704-1:1982 is no more than 70 dB (A).

DISCLAIMER: This set of instructions is given according to IEC 704-1. Advantech disclaims all responsibility for the accuracy of any statements contained herein.

Safety Precaution - Static Electricity

Follow these simple precautions to protect yourself from harm and the products from damage.

- To avoid electrical shock, always disconnect the power from your PC chassis before you work on it. Don't touch any components on the CPU card or other cards while the PC is on.
- Disconnect power before making any configuration changes. The sudden rush of power as you connect a jumper or install a card may damage sensitive electronic components.

Contents

Chapter 1	General Information	1
1.1	Introduction	2
1.2	Specifications	2
1.2.1	Board Information	2
1.2.2	System Information	2
1.2.3	Display	3
1.2.4	Expansion Interface	3
1.2.5	I/O	4
1.2.6	iManager 2.0	4
1.2.7	Mechanical and Environmental Specification	4
1.3	Functional Block Diagram	5
Chapter 2	Mechanical Information	7
2.1	Board Information.....	8
	Figure 2.1 Board Chips Identify - Front.....	8
	Figure 2.2 Board Chips Identify - Back	8
2.2	Mechanical Drawing.....	9
	Figure 2.3 Board Mechanical Drawing - Front	9
	Figure 2.4 Board Mechanical Drawing - Back	9
2.3	Assembly Drawing	10
	Figure 2.5 Assembly Drawing (For Reference Only)	10
Chapter 3	BIOS Operation	11
3.1	Entering Setup	12
3.1.1	Main Setup.....	13
3.1.2	Advanced BIOS Features Setup.....	14
3.1.3	Chipset.....	30
3.1.4	Security Setting.....	42
3.1.5	Boot Settings.....	43
3.1.6	Save & Exit	44
Chapter 4	S/W Introduction & Installation	47
4.1	S/W Introduction.....	48
4.2	Driver Installation	48
4.2.1	Windows Driver Setup	48
4.2.2	Other OS.....	48
4.3	Advantech iManager	49
Appendix A	Pin Assignment	51
A.1	SOM-6897 Type 6 Pin Assignment.....	52
Appendix B	Watchdog Timer	57
B.1	Programming the Watchdog Timer	58

Appendix C	Programming GPIO.....	59
C.1	GPIO Register.....	60
Appendix D	System Assignments.....	61
D.1	System I/O Ports.....	62
	Table D.1: System I/O ports.....	62
D.2	DMA Channel Assignments.....	63
	Table D.2: DMA Channel Assignments.....	63
D.3	Interrupt Assignments.....	63
	Table D.3: Interrupt Assignments.....	63
D.4	1st MB Memory Map.....	64
	Table D.4: 1st MB Memory Map.....	64

Chapter 1

General Information

This chapter gives background information on the SOM-6897 CPU Computer on Module.

Sections include:

- Introduction
- Specification
- Functional Block Diagram

1.1 Introduction

SOM-6897 is a COM Express Compact module with pin-out Type 6 that fully complies with the PICMG (PCI Industrial Computer Manufacturers Group) COM.0 R2.1 specification. The CPU module uses an Intel 6th Generation Core i processor and other peripheral chips to fulfill a basic size 95x95mm COM Express form factor. SOM-6897 features a 15 watt TDP and is equipped with a power-saving ULV-SoC on new 14nm micro architecture. It brings 15% performance improvements and 20% improvements on 3D graphics over previous models. SOM-6897 is equipped with the integrated Intel Gen 9 graphics micro architecture, supplying up to three independently operated 4K displays via DisplayPort. It also supports HEVC, VP8, VP9 and VDENC decoding/encoding in hardware. SOM-6897 provides interfaces such as PCI Express Gen 3, SATA Gen 3, and USB3.0. Moreover, 5 PCIe x1 (with LAN) or 1 PCIe x4 and 4 PCIe x1 (with LAN) can be supported at a time to make the IO design more flexible. In addition, SOM-6897 added a mounting hole around processor to strengthen the board structure and avoid board bending.

Advantech iManager was designed to satisfy a lot of embedded application requirements such as multi-level watchdog timer, voltage and temperature monitoring, and thermal protection through processor throttling, as well as LCD backlight on/off, brightness control, and embedded storage information. Combined with Advantech SUSI Access, it can remotely monitor and control devices via the internet for easy maintenance. All Advantech COM Express modules integrate iManager and SUSI Access to benefit customer's applications. SOM-6897 is suitable for computing intensive, thermal sensitive, graphics/media intense, and I/O demanding applications.

1.2 Specifications

1.2.1 Board Information

- **Pin Definition:** PICMG COM.0 R2.1 Type 6 pin-out definition
- **Form Factor:** PICMG COM.0 R2.1 Compact Module 95 x 95 mm

1.2.2 System Information

- **CPU:** 6th Gen Intel® Core Processors

CPU	Standard Freq.	Max. Turbo Freq.	Core	Cache (MB)	TDP(W)
i7-6600U	2.6GHz	3.4GHz	2	4	15
i5-6300U	2.4GHz	3.0GHz	2	3	15
i3-6100U	2.3GHz	NA	2	3	15
Celeron 3955U	2.0GHz	NA	2	2	15

- **Memory:** 2 x SODIMM sockets for DDR3L-1600, up to 16 GB
- **BIOS:** AMI UEFI
- **Power management:** Supports power saving modes including Normal / Standby / Suspend modes. ACPI 2.0 compliant.

1.2.3 Display

- **Graphic Core:** Intel® Gen9 HD Graphics supportong DX11.1, OGL4.4, OCL1.2, and MPEG2, AVC/H.264, VC-1 HW decode/encode/transcode acceleration.

CPU	Graphics Core	Base Freq.	Max Freq.
i7-6600U	Intel® HD Graphics 520	300MHz	1.05 GHz
i5-6300U	Intel® HD Graphics 520	100MHz	1GHz
i3-6100U	Intel® HD Graphics 520	300MHz	1GHz
Celeron 3955U	Intel® HD Graphics 510	300MHz	900MHz

- **VGA:** Resolution up to 1920 x 1200
- **LVDS:** Single and dual channel 18/24-bit resolutions up to 1920 x 1200 @ 60 Hz
- **HDMI/DVI/DP:** 1 x port, plus 2 x optional by removing VGA, configurable to HDMI1.4/DVI/Displayport 1.2.
Resolution: HDMI up to 4096 x 2160 @24Hz
DVI up to 1920 x 1080 @ 60 Hz
DP up to 3840 x 2160 @ 60Hz 24 bpp or 4096 x 2304 @ 60Hz 24 bpp
- **Dual Display:** VGA + LVDS, VGA + HDMI/DVI/DP, LVDS + HDMI/DVI/DP, HDMI/DVI/DP + HDMI/DVI/DP
- **Triple Display:** LVDS + DP + DP/HDMI, LVDS + DP + VGA, LVDS + HDMI + HDMI, DP + DP + DP, DP + HDMI +HDMI, DVI + DP + HDMI, VGA + DP + HDMI

1.2.4 Expansion Interface

- **PCI Express x1:** 5 PCIe x1 or 4 PCIe x1 + 1 PCIe x4
(support up to 5 devices and 8 lanes)
To PCIe Gen2* (5.0 GT/s) specification, several configurable combinations may need BIOS modifies. Please contact Advantech sales or FAE for more detail.
(PCIe x1 Port #7 option with SATA2)

	PCIe #0-3				PCIe #4-7	
Option 1	x4				x4	
Option 2	x4		x2		x2	
Option 3	x4		x2		x1	x1
Option 4	x4		x1	x1	x1	x1
Option 5	x2	x2		x2		x2
Option 6	x2	x2		x1	x1	x1
Default	x1	x1	x1	x1	x1	

- **Audio Interface:** Intel HD Audio interface
- **LPC Bus:** Yes(24MHz)
- **SMBus:** Yes
- **I2C Bus:** Yes
- **SPI:** Supports SPI BIOS only

1.2.5 I/O

- **Ethernet:** Intel I219LM Gigabit LAN supports 10/100/1000 Mbps Speed.
- **SATA:** Supports 3 ports SATA Gen3 (6 Gb/s)
(option with PCIe x1 port #7 can be 4 ports SATA).
- **USB Interface:** Supports 4 x ports USB 3.0, 8 x ports USB 2.0.
- **Serial Port:** Supports 2 x ports and a 2-wire serial port.
- **Express Card:** 2 x ports.
- **Panel Control:** Supports panel backlight on/off control, brightness control.
- **Thermal Protection:** Supports thermal shutdown or CPU throttling.
- **Watchdog Timer:** 65536 level timer interval, from 0~65535 sec, multi-level, multi-option watchdog timer.
- **Smart Fan:** 1 x port on module, 1 x port on carrier board.
- **GPIO:** 8-bit GPIO.
- **Hardware Monitor:** Vin, 5VSB, RTC battery.
- **TPM:** BOM option, default not available.

1.2.6 iManager 2.0

Refer to section 4.3.

1.2.7 Mechanical and Environmental Specification

- **Dimensions:** 95 x 95 mm (3.74" x 3.74")
- **Power Type and Supply Voltage:**
 - ATX: +8.5~20V and +4.75~5.25VSB (standby power)
 - AT: +8.5~20V
 - CMOS Battery: +3.3V
- **Power Requirement:**
 - Test condition: SOM-6897C3-U3A1E (i3-6100U), DDR3L-1600 16GB, WIN8.1 64-bit, under 12V and 5VSB input power supply
 - Idle: 2.76W
 - Max: 23.44W (Burn-in V6.0 Pro)
- **Temperature Specification:**
 - Operating: 0 ~ 60° C (32 ~ 140° F)
 - Storage: -40 ~ 85° C (-40 ~ 185° F)
- **Humidity Specification:**
 - Operating: 40° C @ 95% relative humidity, non-condensing
 - Storage: 60° C @ 95% relative humidity, non-condensing

1.3 Functional Block Diagram

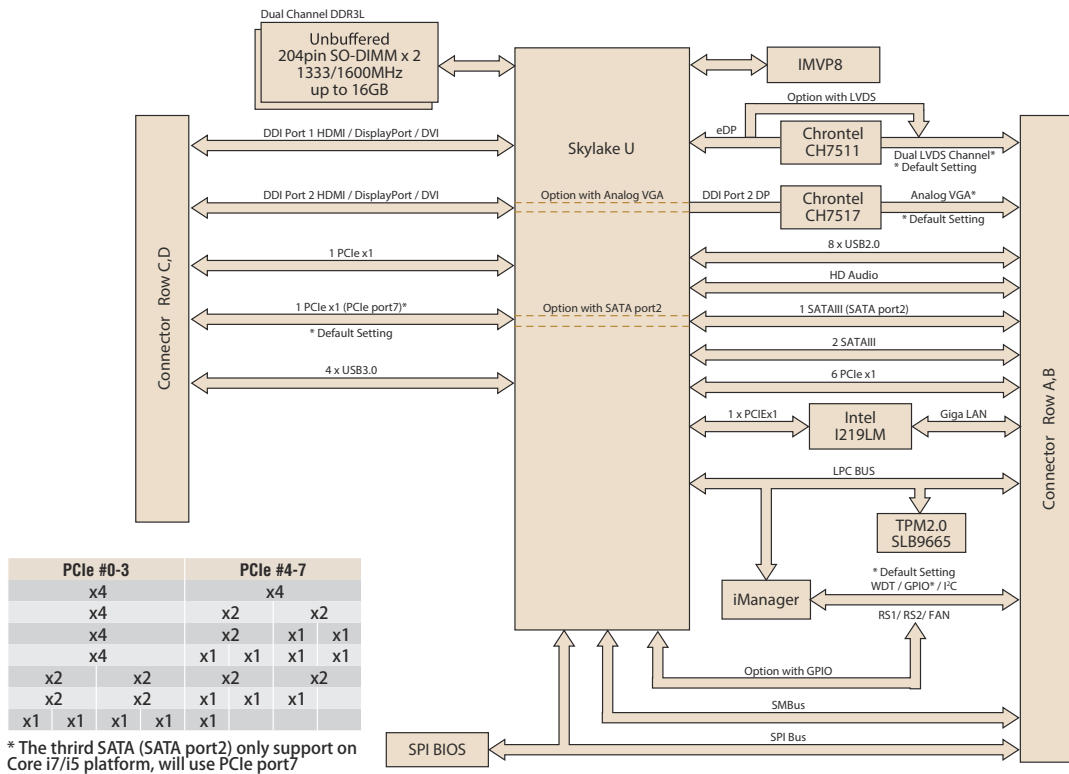

Chapter 2

Mechanical Information

This chapter gives mechanical information on the SOM-6897 CPU Computer on Module.

Sections include:

- Board Information
- Mechanical Drawing
- Assembly Drawing

2.1 Board Information

The figures below indicate the main chips on SOM-6897 Computer-on-Module. Please aware of these positions while designing your own carrier board to avoid mechanical issues, as well as designing thermal solution contact points for best thermal dissipation performance.

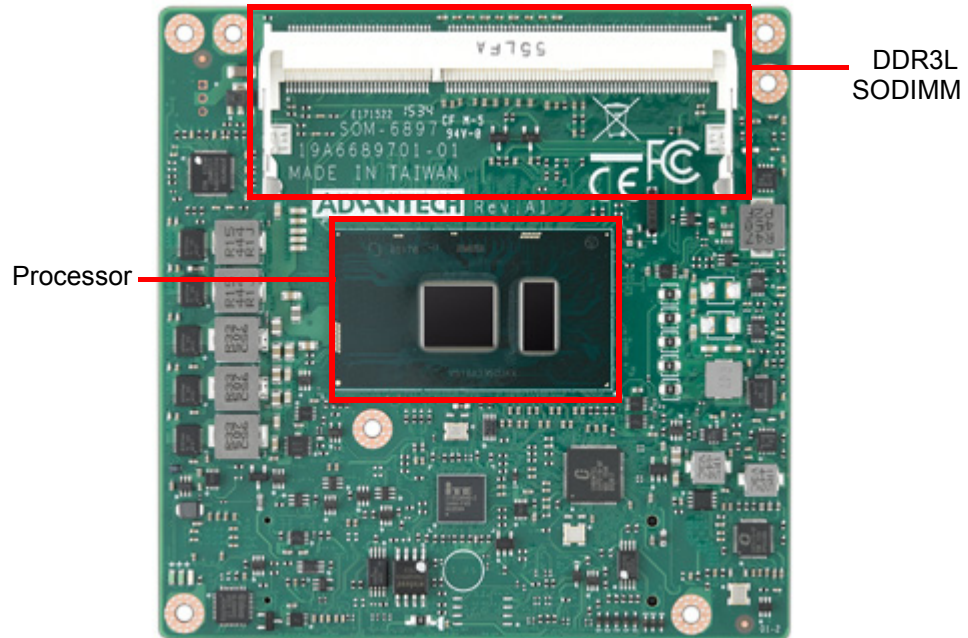

Figure 2.1 Board Chips Identify - Front

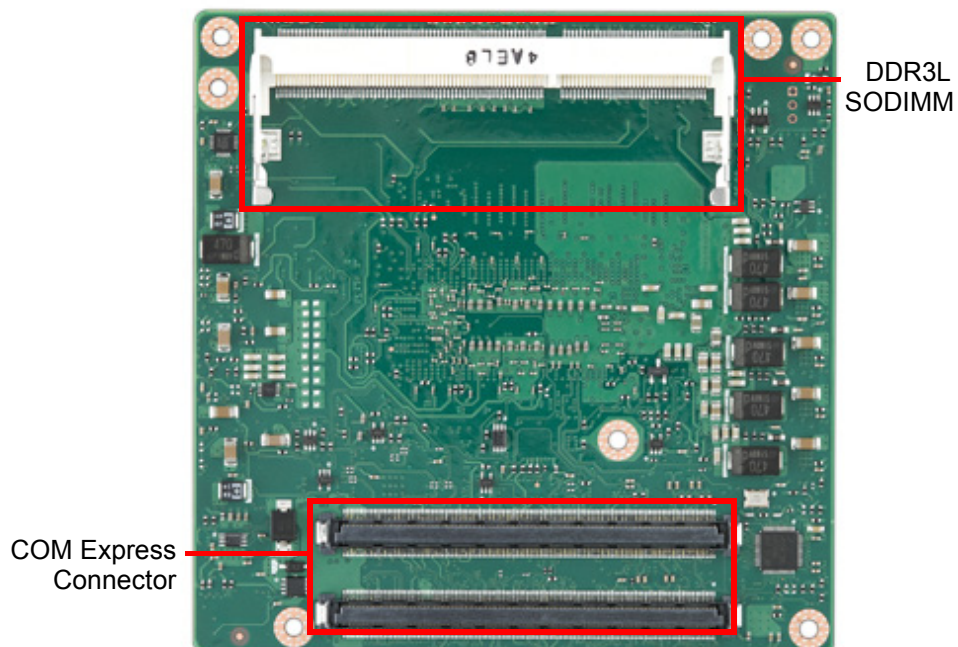

Figure 2.2 Board Chips Identify - Back

2.2 Mechanical Drawing

For more details about 2D/3D models, please look on the Advantech COM support service website <http://com.advantech.com>.

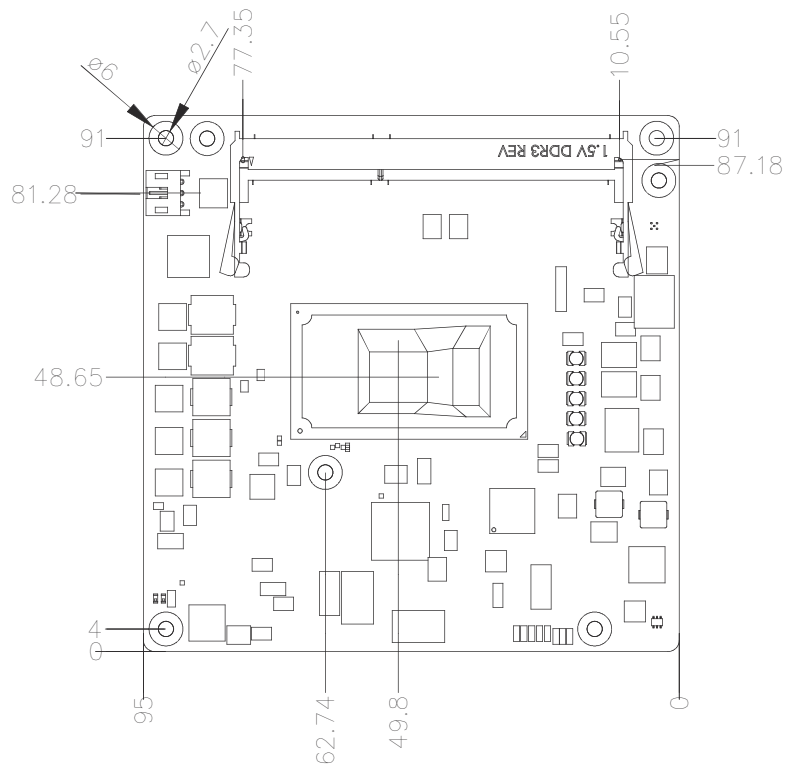

Figure 2.3 Board Mechanical Drawing - Front

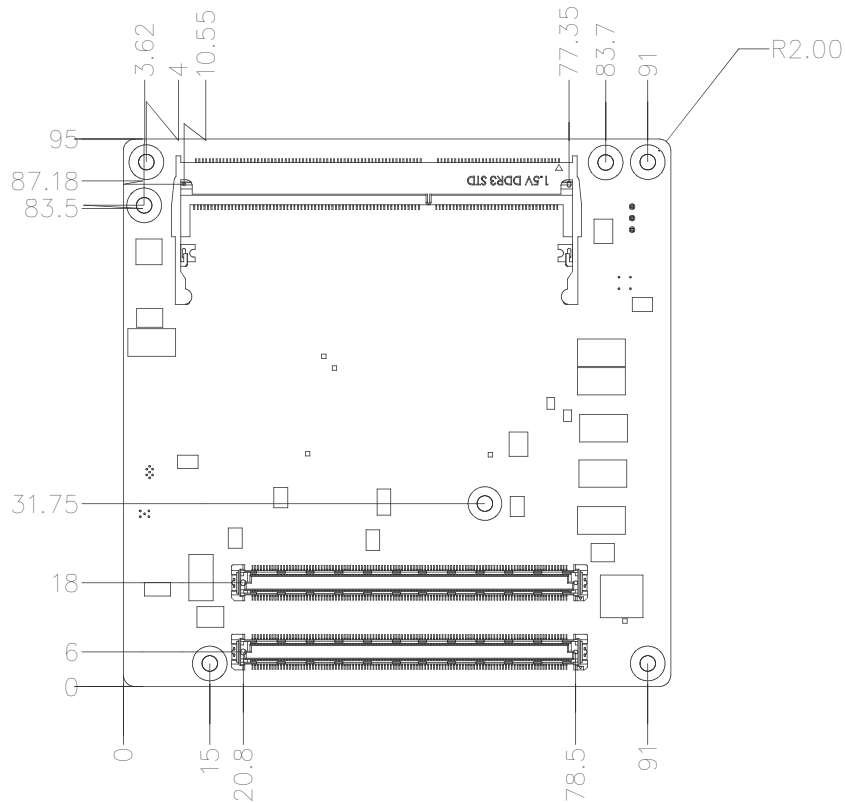

Figure 2.4 Board Mechanical Drawing - Back

2.3 Assembly Drawing

These figures demonstrate the assembly order from the thermal module, COM module to the carrier board.

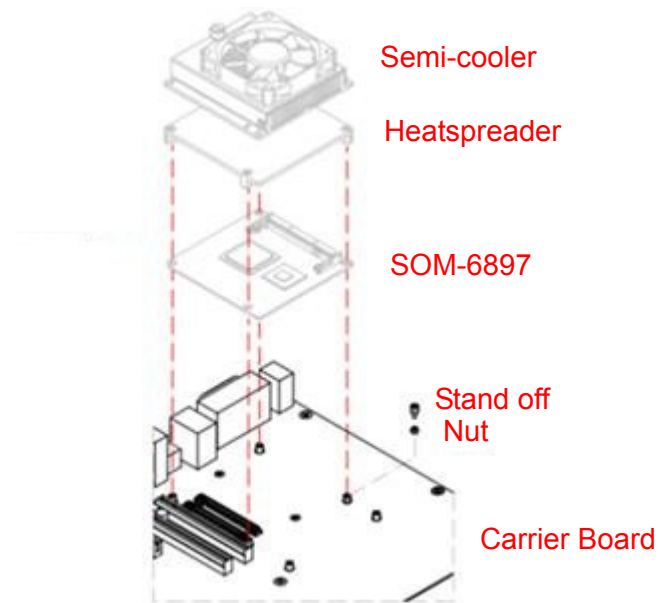

Figure 2.5 Assembly Drawing (For Reference Only)

There are 3 reserved screw holes for SOM-6897 to be pre-assembled with the heat spreader.

Chapter 3

BIOS Operation

This chapter gives BIOS setup information for the SOM-6897 CPU Computer on Module.

Sections include:

- Introduction
- Entering Setup
- Hot / Operation Key
- Exit BIOS Setup Utility

3.1 Entering Setup

SOM-6897 BIOS has been stored into a flash ROM which is inserted into a BIOS socket on the board. With the BIOS Setup program, users can modify BIOS settings and control various system features. This chapter describes the basic navigation of the SOM-6897 BIOS setup screens.

Advantech will have revisions for product optimization, and users can re-flash the latest BIOS through the AFU utility. Please contact Advantech sales or FAE for more details.

Turn on the computer and then press <ESC> or to enter Setup menu.



SOM-6897 BIOS has a built-in Setup program that allows users to modify the basic system configuration. This information is stored in flash ROM so it retains the Setup information when the power is turned off.

3.1.1 Main Setup

When users first enter the BIOS Setup Utility, they will enter the main setup screen. Users can always return to the Main setup screen by selecting the Main tab. There are two Main Setup options. They are described in this section. The Main BIOS setup screen is shown below.



The Main BIOS setup screen has two main frames. The left frame displays all the options that can be configured. Grayed-out options cannot be configured; options in blue can. The right frame displays the key legend.

Above the key legend is an area reserved for a text message. When an option is selected in the left frame, it is highlighted in white. Often a text message will accompany it.

■ System time / System date

Use this option to change the system time and date. Highlight System Time or System Date using the <Arrow> keys. Enter new values through the keyboard. Press the <Tab> key or the <Arrow> keys to move between fields.

- System Date: mm/dd/yyyy
- System Time: hh/mm/ss

3.1.2 Advanced BIOS Features Setup

Select the Advanced tab from the SOM-6897 setup screen to enter the Advanced BIOS Setup screen. Users can select any item in the left frame of the screen, such as CPU Configuration, to go to the sub menu for that item. Users can display an Advanced BIOS Setup option by highlighting it using the <Arrow> keys. All Advanced BIOS Setup options are described in this section. The Advanced BIOS Setup screens are shown below. The sub menus are described on the following pages.

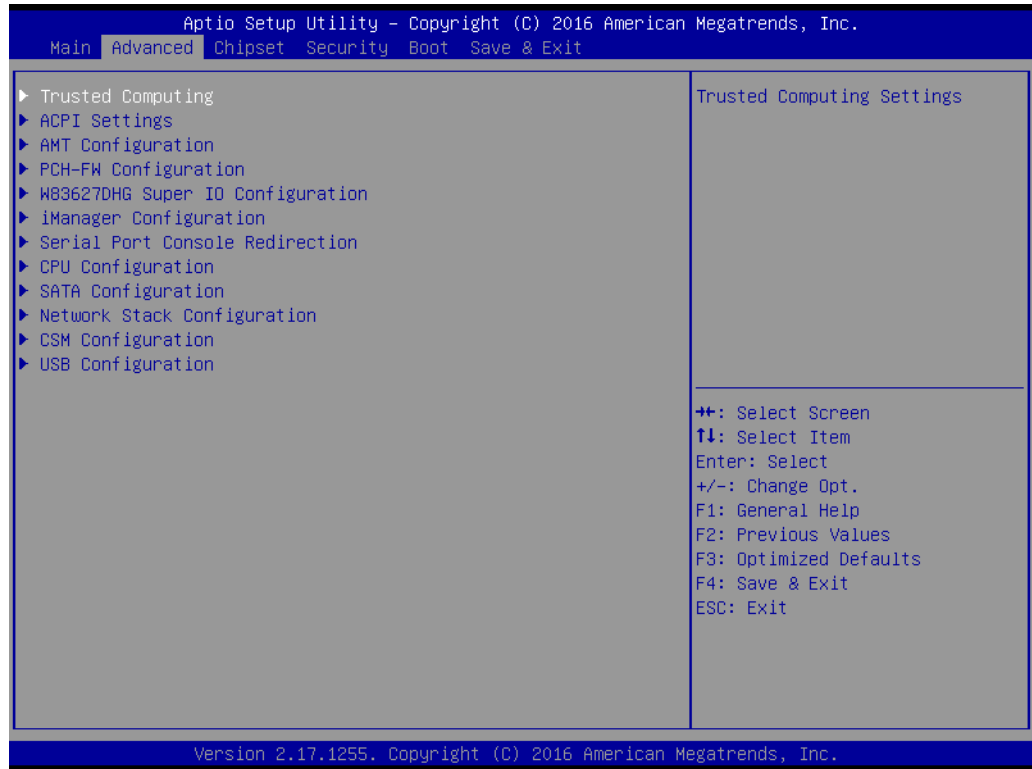

3.1.2.1 Trusted Computing

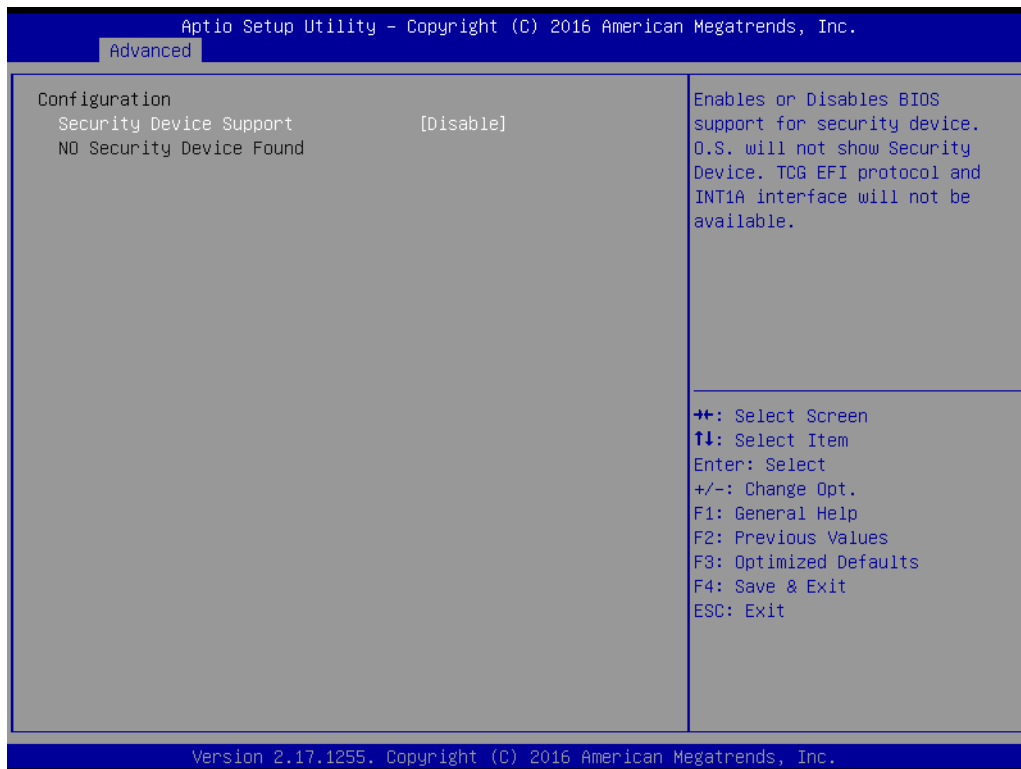

■ Security Device Support

Enable or disable BIOS support for security devices. OS will not show security device. TCG EFI protocol and INT1A interface will not be available.

3.1.2.2 ACPI Settings

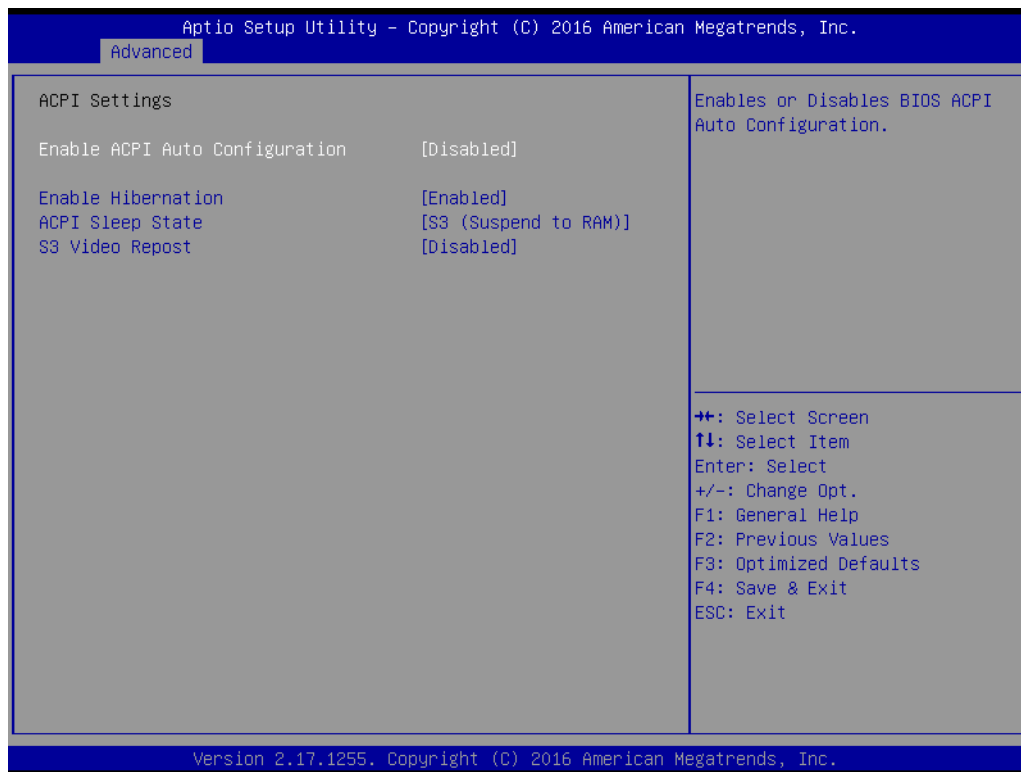

- **Enable ACPI Auto Configuration**
This item allows users to enable or disable BIOS ACPI auto configuration.
- **Enable Hibernation**
This item allows users to enable or disable system ability to hibernate (OS/S4 Sleep State). This option may be not effective with some OS.
- **ACPI Sleep State**
This item allows users to select the highest ACPI sleep state the system will enter when the suspend button is pressed.
- **S3 Video Repost**
This item allows users to enable or disable S3 Video Repost.

3.1.2.3 AMT Configuration

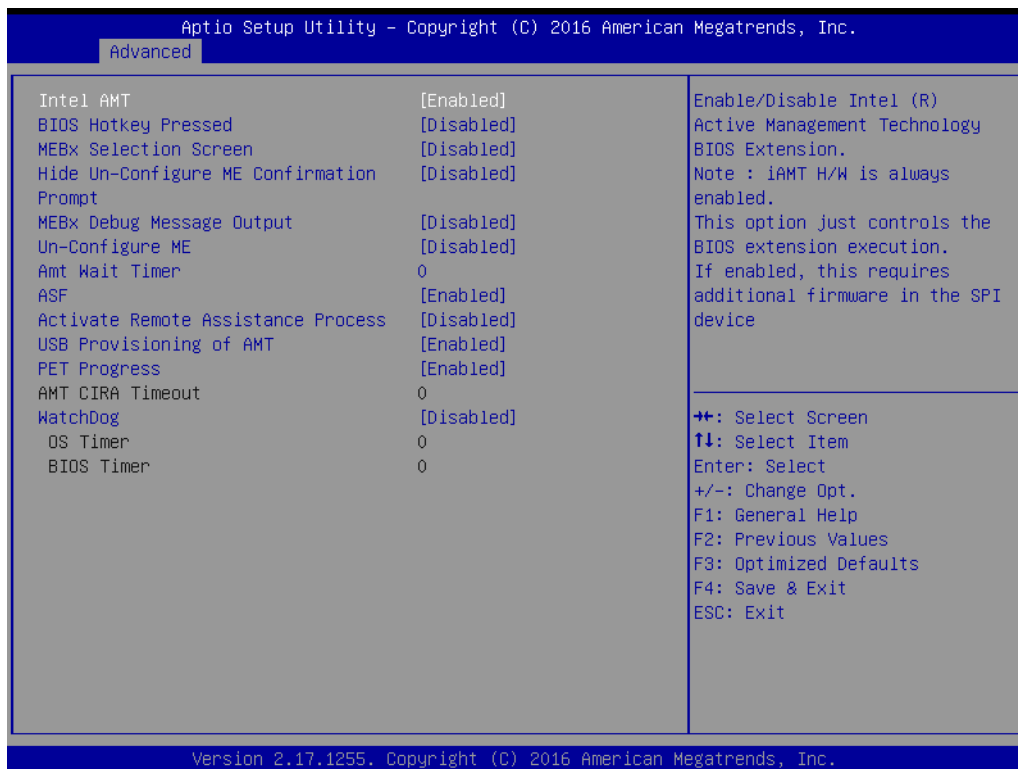

- **Intel AMT**
Enable or disable Intel ® Active Management Technology BIOS Extension. Note: iAMT H/W is always enabled. This option just controls the BIOS extension execution. If enabled, this requires additional firmware in the SPI device.
- **BIOS Hotkey Pressed**
OEMFlag Bit 1: Enable or disable BIOS hotkey press.
- **MEBx Selection Screen**
OEMFlag Bit 2: Enable or disable selection screen.
- **Hide Un-Configuration ME Confirmation Prompt**
OEMFlag Bit 6: Hide Un-configure ME without password confirmation prompt.
- **MEBx Debug Message Output**
OEMFlag Bit 14: Enable debug message output.
- **Un-Configure ME**
OEMFlag Bit 15: Un-Configure ME without password.
- **Amt Wait Timer**
Set timer to wait before sending ASF_GET_BOOT_OPTIONS.
- **ASF**
Enable or disable BIOS Alert specification format.
- **Activate Remote Assistance Process**
Trigger CIRA boot.
- **USB Provisioning of AMT**
Enable or disable of AMT USB provisioning.
- **PET Progress**
This item for users to enable or disable PET events progress to receive PET events or not.

- **WatchDog**
Enable or disable watchdog timer.

3.1.2.4 PCH-FW Configuration

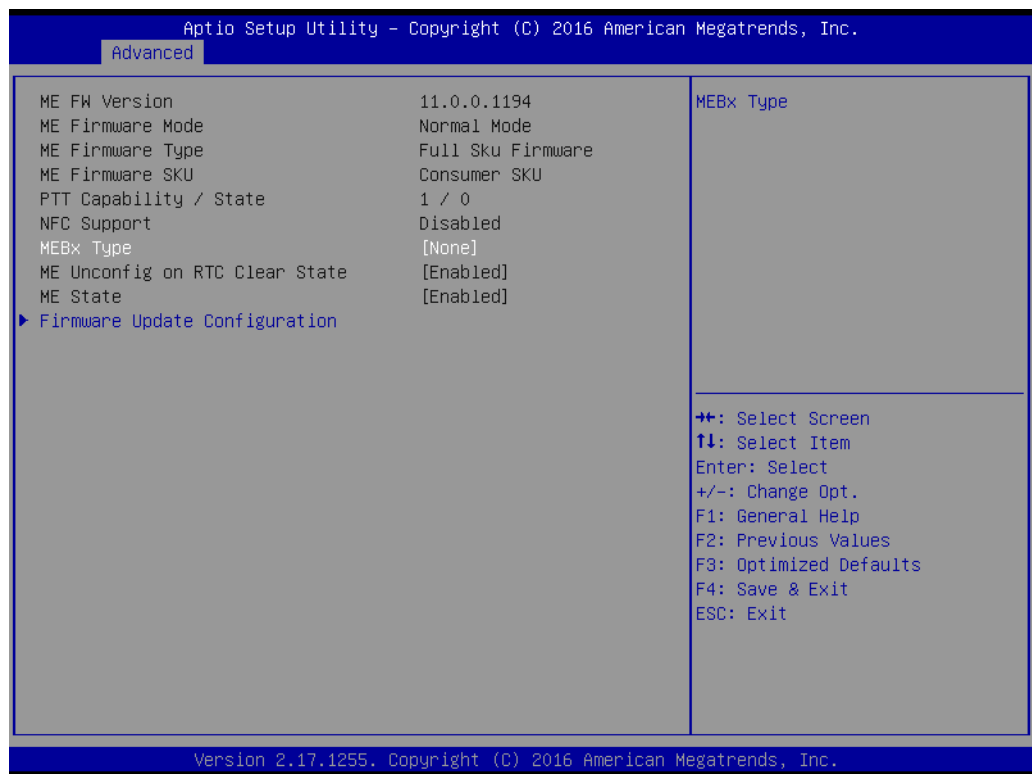

- **MEBx Type**
MEBx Type
- **ME Unconfig on RTC Clear State**
Disabling this option will cause ME not to unconfigure on RTC clear state.
- **ME State**
Sets ME to soft temporary disabled.
- **Firmware Update Configuration**
Configures management engine technology parameters.

3.1.2.5 W83627DHG Super IO Configuration

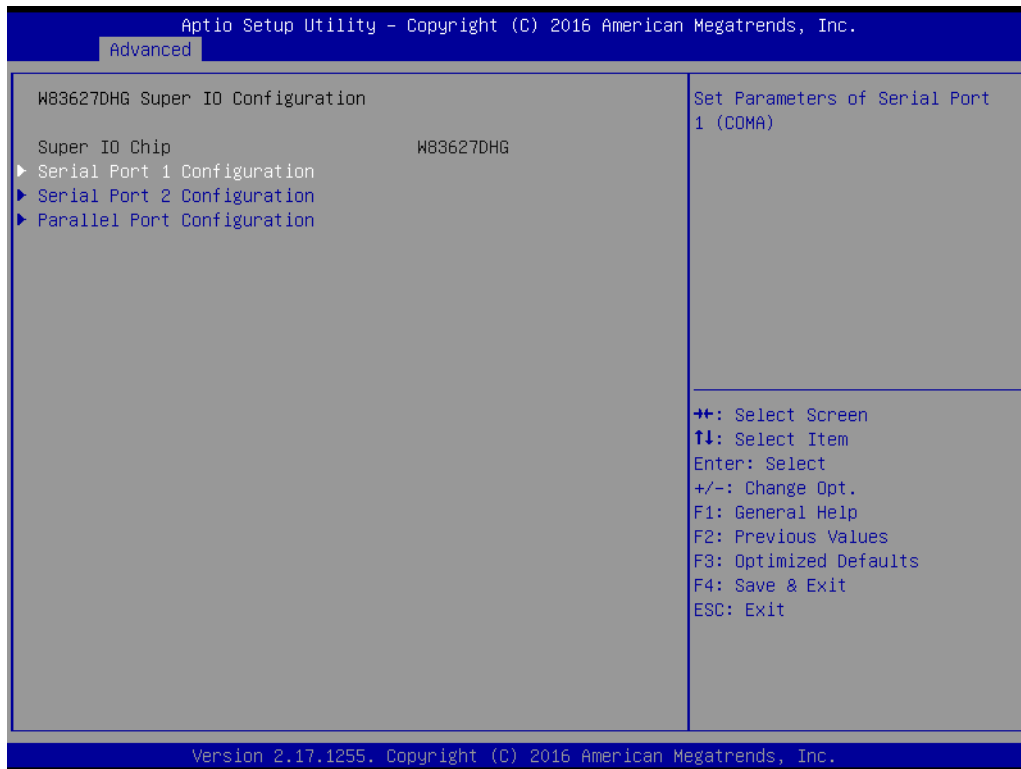

- **Serial Port 1 Configuration**
Set parameters of serial Port 1 (COMA).
- **Serial Port 2 Configuration**
Set parameters of serial Port 2 (COMB).
- **Parallel Port Configuration**
Set parameters of parallel Port (LPT/ LPTE).

■ Serial Port 1 Configuration

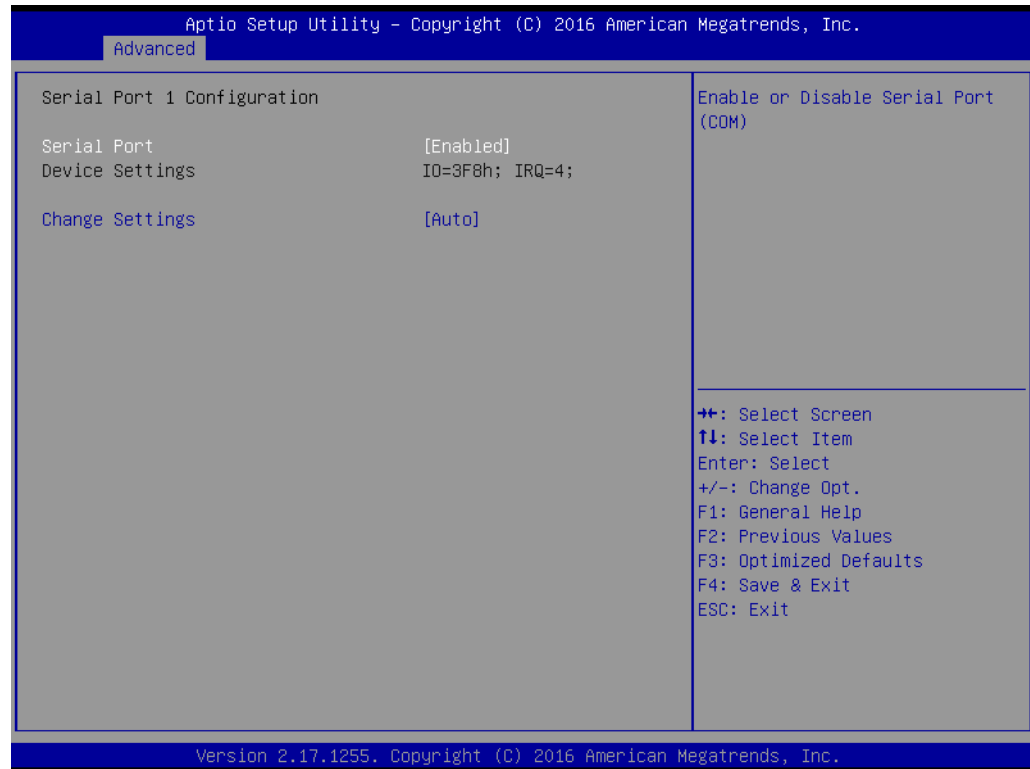

- **Serial Port**
Enable or disable Serial Port (COM).
- **Change Settings**
Select an optimal setting for Super IO device.

■ Serial Port 2 Configuration

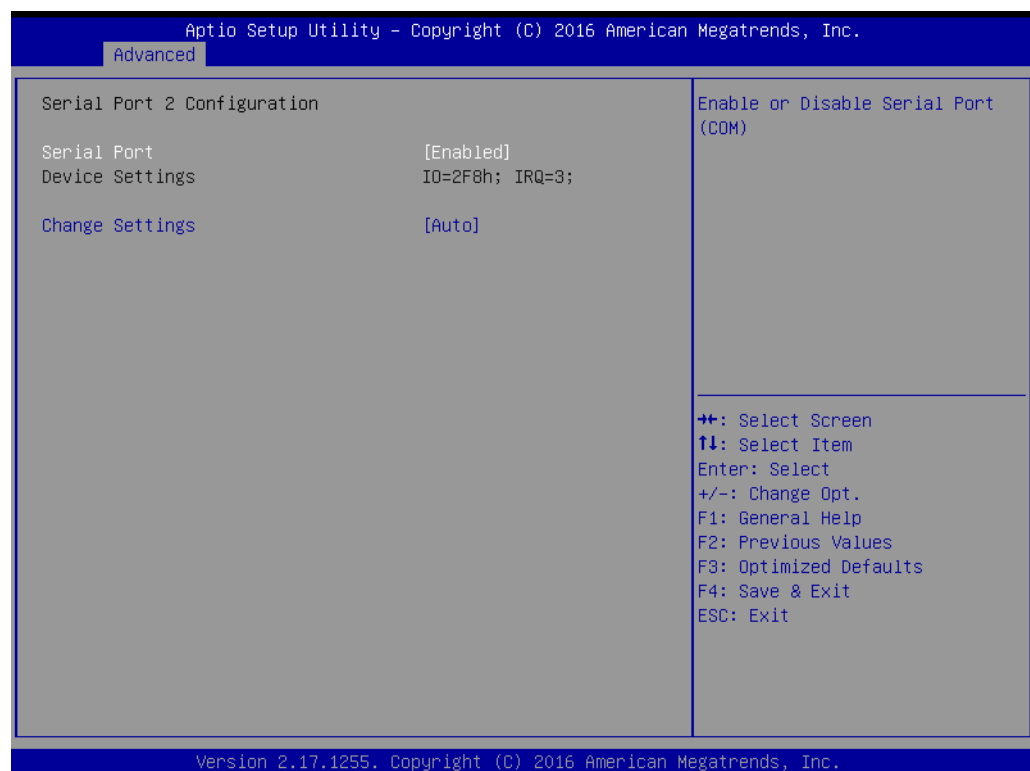

- **Serial Port**
Enable or disable Serial Port (COM).
- **Change Settings**
Select an optimal setting for Super IO device.
- **Parallel Port Configuration**

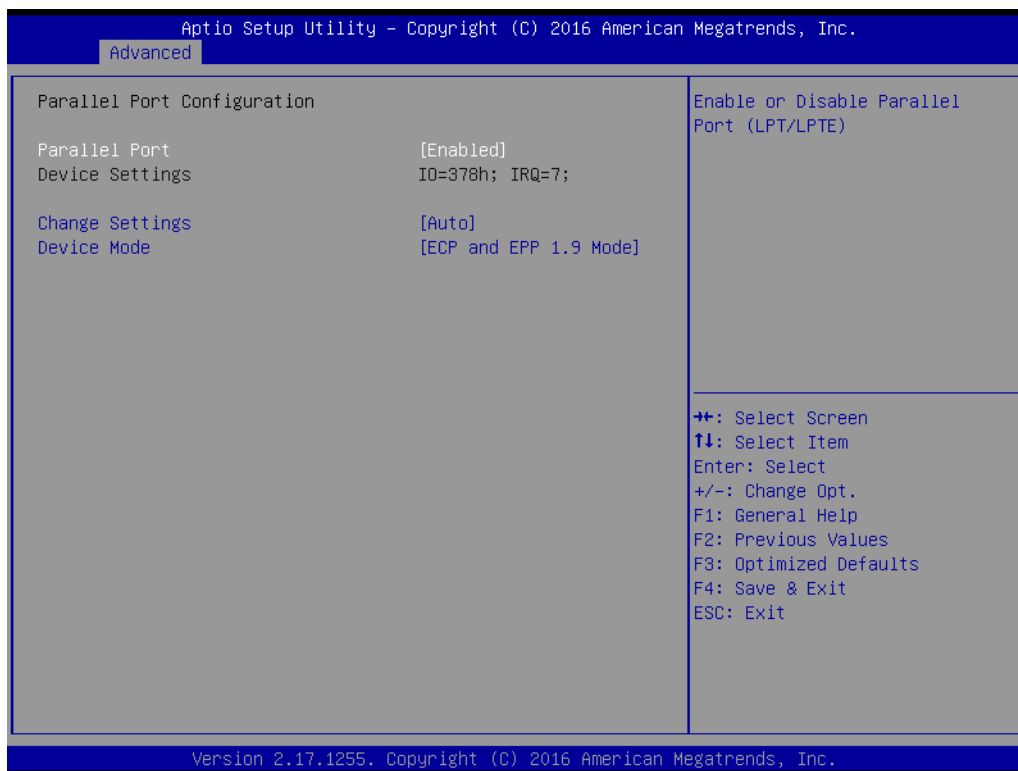

- **Parallel Port**
Enable or disable parallel port (LPT/LPTE).
- **Change Settings**
Select an optimal setting for Super IO device.
- **Device Mode**
Change the printer port mode.

3.1.2.6 iManager Configuration

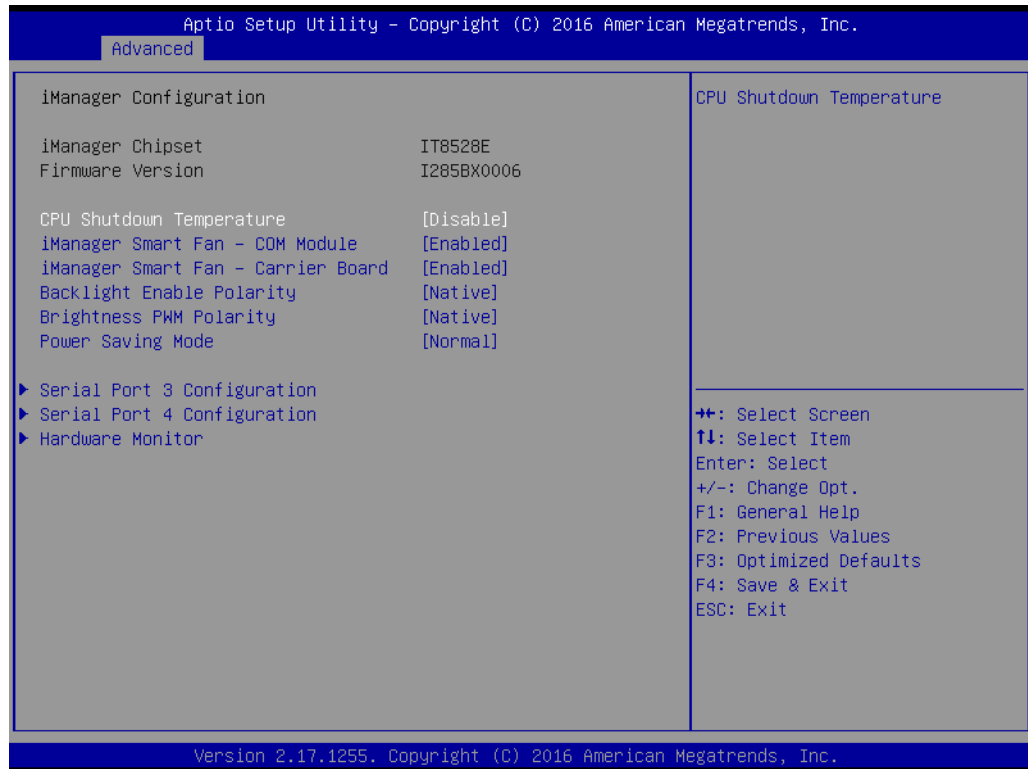

- **CPU Shutdown Temperature**
CPU shutdown temperature.
- **iManager Smart Fan - COM Module**
Controls iManager smart FAN function.
- **iManager Smart Fan - Carrier Board**
Controls iManager Smart FAN carrier board function.
- **Backlight Enable Polarity**
Switches Backlight Enable Polarity to native or invert.
- **Brightness PWM Polarity**
Backlight control brightness PWM polarity for native or invert.
- **Power Saving Mode**
Selects ite8518 power saving mode.
- **Serial Port 3 Configuration**
Sets parameters of serial port 3 (COMA).
- **Serial Port 4 Configuration**
Sets parameters of serial port 4 (COMB).
- **Hardware Monitor**
Monitors hardware status.

■ Serial Port 3 Configuration

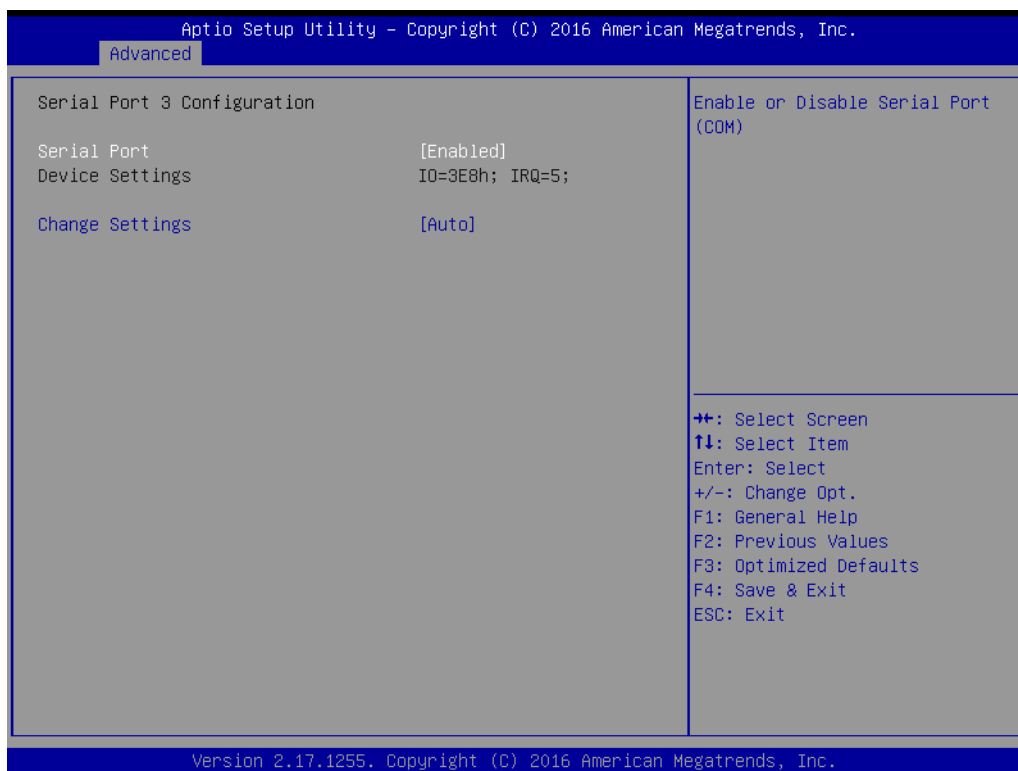

– Serial Port

Enable or disables serial port (COM).

– Change Settings

Select an optimal setting for Super IO device.

■ Serial Port 4 Configuration

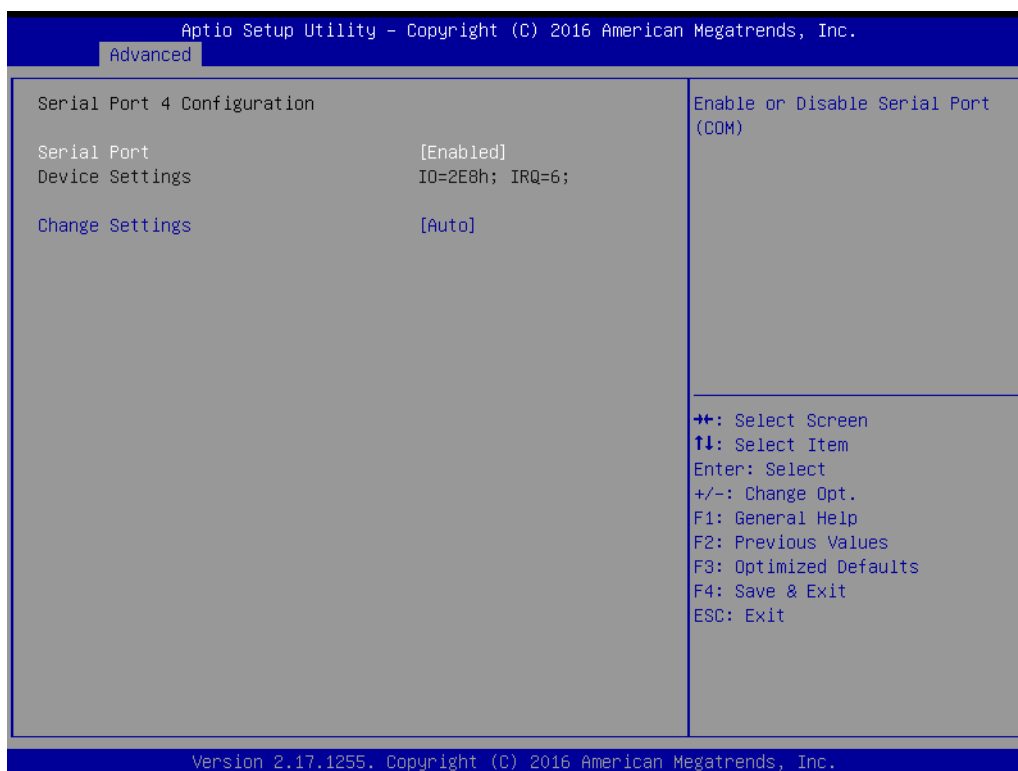

- **Serial Port**
Enable or disables. serial port (COM).
- **Change Settings**
Selects an optimal setting for Super IO device.

■ **Hardware Monitor**

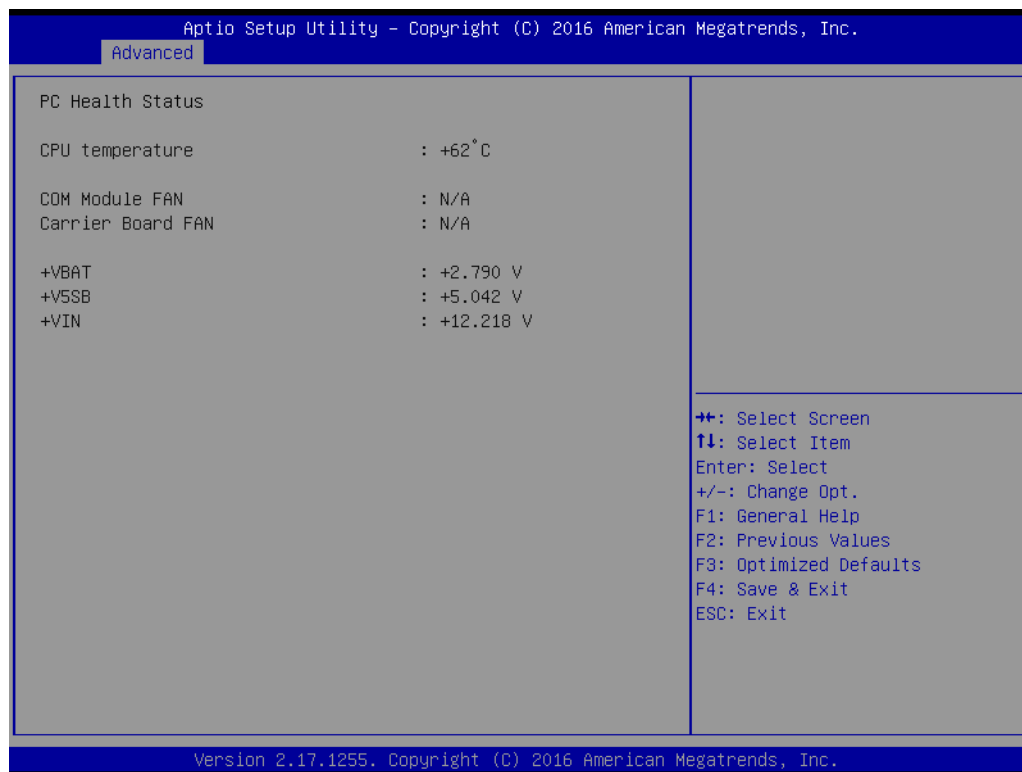

3.1.2.7 Serial Port Console Redirection

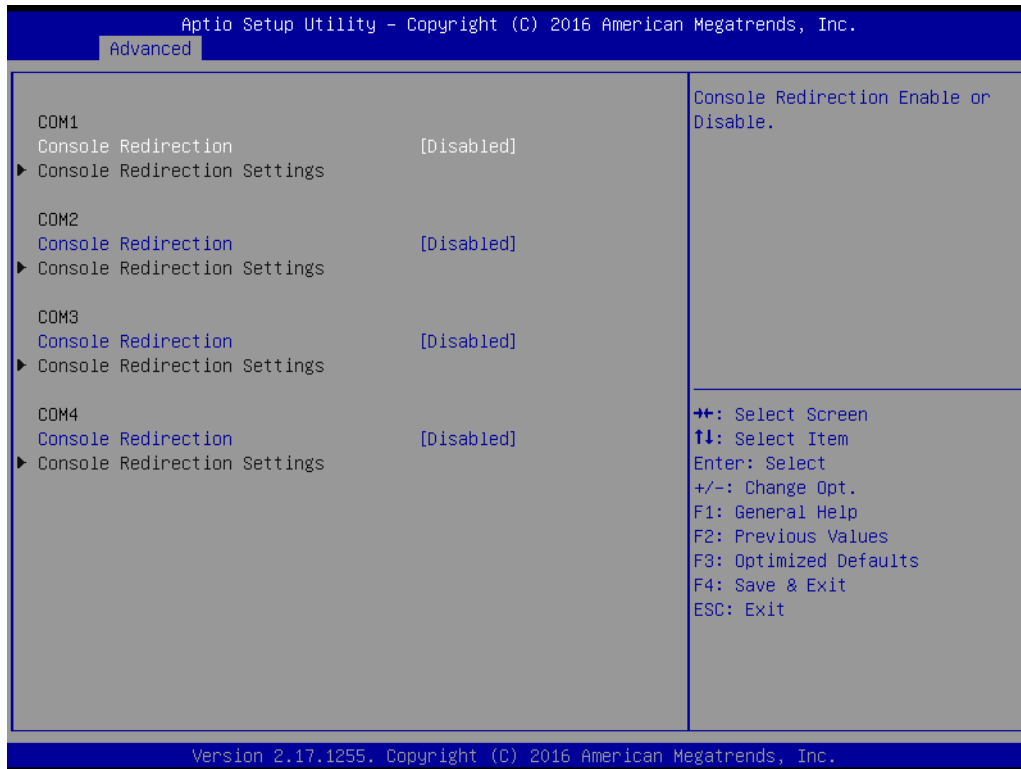

- **COM1**
Console Redirection
Console Redirection enable or disable
- **COM2**
Console Redirection
Console Redirection enable or disable
- **COM3**
Console Redirection
Console Redirection enable or disable
- **COM4**
Console Redirection
Console Redirection enable or disable

3.1.2.8 CPU Configuration

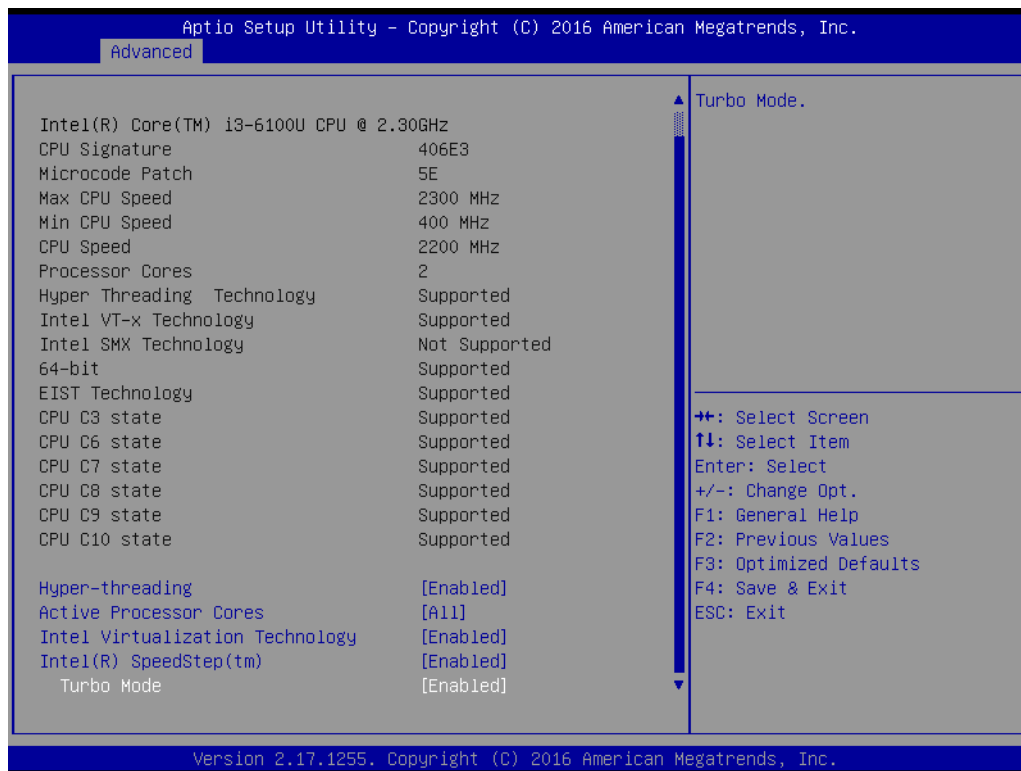
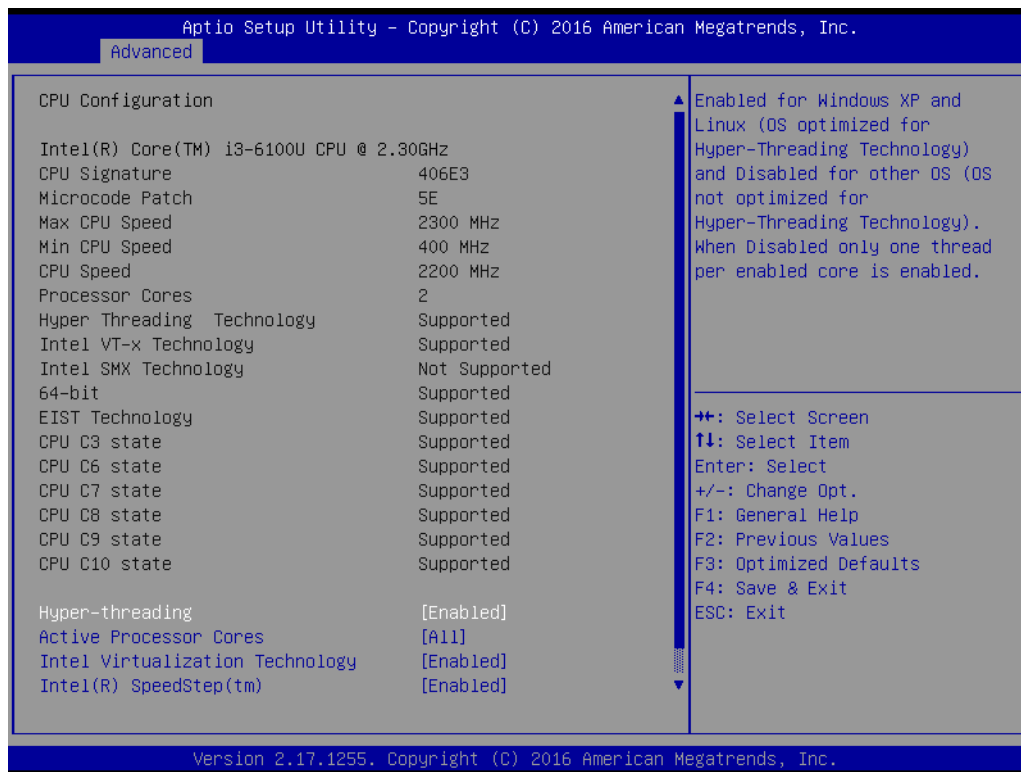

- **Hyper-Threading**

This item allows users to enable for Windows XP and Linux (OS optimized for Hyper Threading technology) and disable for other OS (OS not optimized for Hyper Threading technology). When disabled only one thread per enabled core is activated.

- **Active Processor Cores**
This item allows users to set how many processor cores should be active.
- **Intel Virtualization Technology**
When enabled, a VMM can utilize additional hardware capabilities provided by vanderpool technology.
- **Intel(R) SpeedStep(tm)**
Allows more than two frequency ranges to be supported.
- **Turbo Mode**
Turbo Mode.

3.1.2.9 SATA Configuration

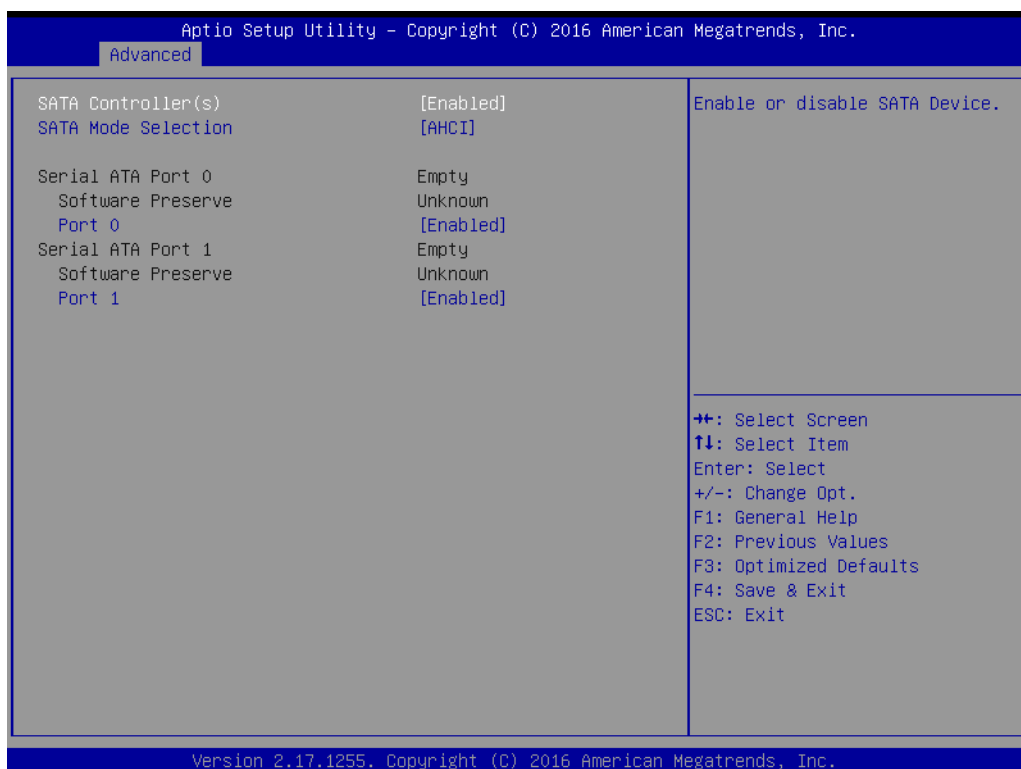

- **SATA Controller (S)**
Enable or disable SATA device.
- **SATA Mode Selection**
Determines how SATA controller (s) operate.
- **Port 0**
Enable or disable SATA port.
- **Port 1**
Enable or disable SATA port.

3.1.2.10 Network Stack Configuration



- **Network Stack**
Enable or disable UEFI Network Stack.

3.1.2.11 CSM Configuration

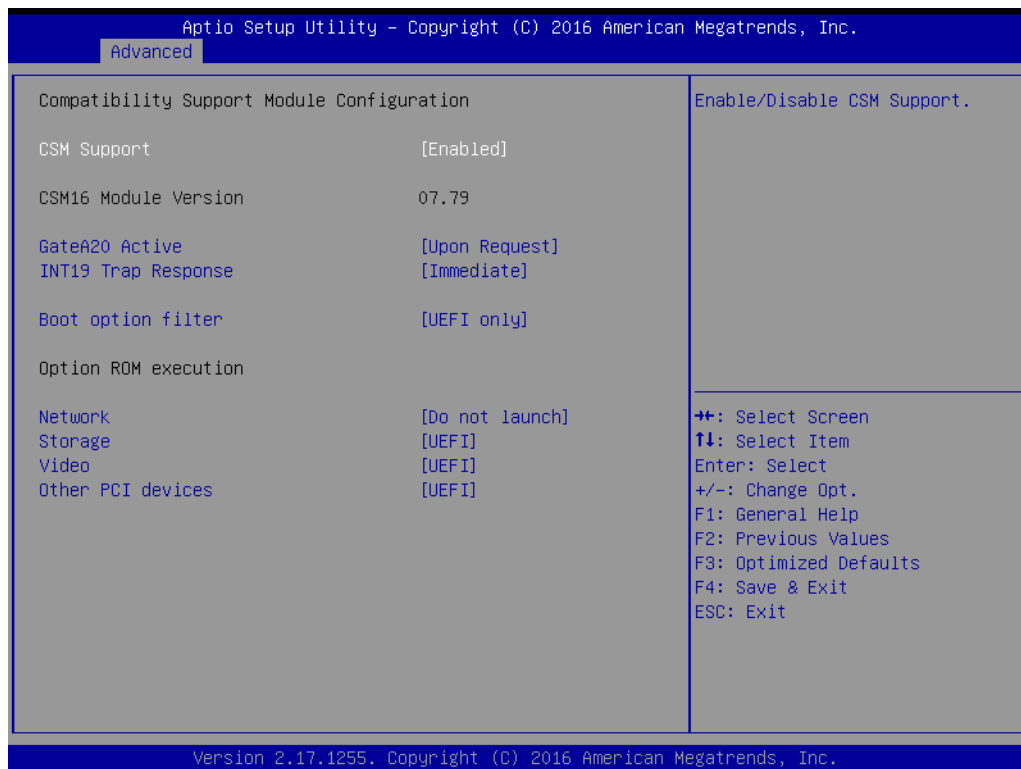

- **CSM Support**
Enable or disable CSM support.

- **GateA20 Active**
UPON Request- GA20 can be disabled using BIOS services. Do not allow disabling GA20; this option is useful when any RT code is executed above 1MB.
- **INT19 Trap Response**
BIOS reaction on INT19 trapping by option ROM: IMMEDIATE – execute the trap right away; POSTPONED – execute the trap during legacy boot.
- **Boot option filter**
This option controls legacy/UEFI ROMs priority.
- **Network**
Controls the execution of UEFI and legacy PXE OpROM.
- **Storage**
Controls the execution of UEFI and legacy storage OpROM.
- **Video**
Controls the execution of UEFI and legacy video OpROM.
- **Other PCI devices**
Determines OpROM execution policy for devices other than network, storage, or video.

3.1.2.12 USB Configuration

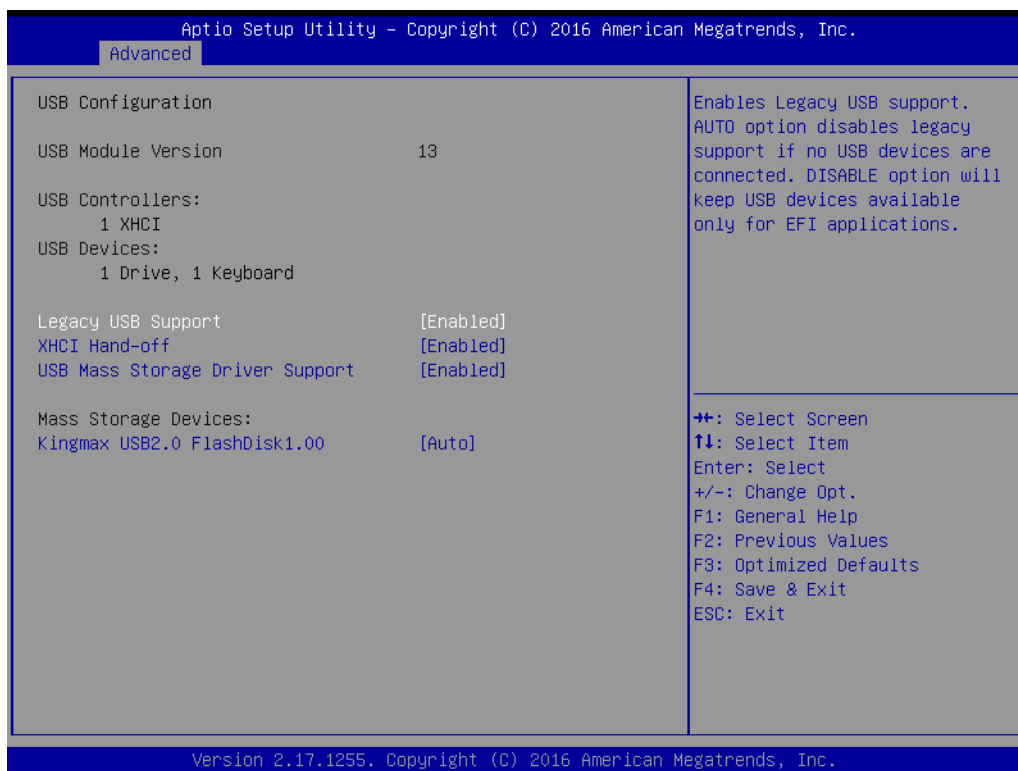

- **Legacy USB Support**
Enables Legacy USB support. Auto option disables legacy support if no USB devices are connected. Disable option will keep USB devices available only for EFI applications.
- **XHCI Hand-off**
This is a workaround for OS without XHCI ownership change should be claimed by XHCI driver.
- **USB Mass Storage Driver Support**
Enable or disable USB Mass Storage Driver Support.

3.1.3 Chipset

Select the chipset tab from the SOM-6897 setup screen to enter the chipset BIOS Setup screen. You can display a chipset BIOS setup option by highlighting it using the <Arrow> keys. All Plug and Play BIOS setup options are described in this section. The Plug and Play BIOS Setup screen is shown below.

3.1.3.1 System Agent Bridge Name

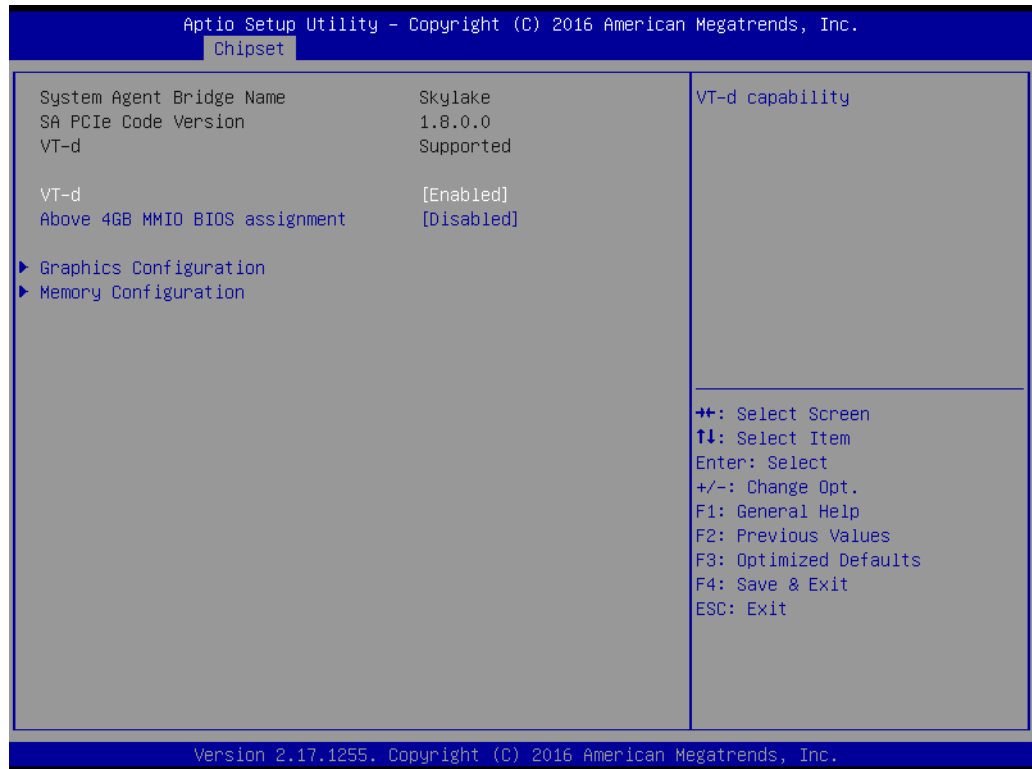

- **VT-d**
VT-d capability.
- **Above 4GB MMIO BIOS assignment**
Enable or disable above 4GB memory mapped IO BIOS assignment. This is disabled automatically when aperture size is set to 2048MB.

■ Graphics Configuration

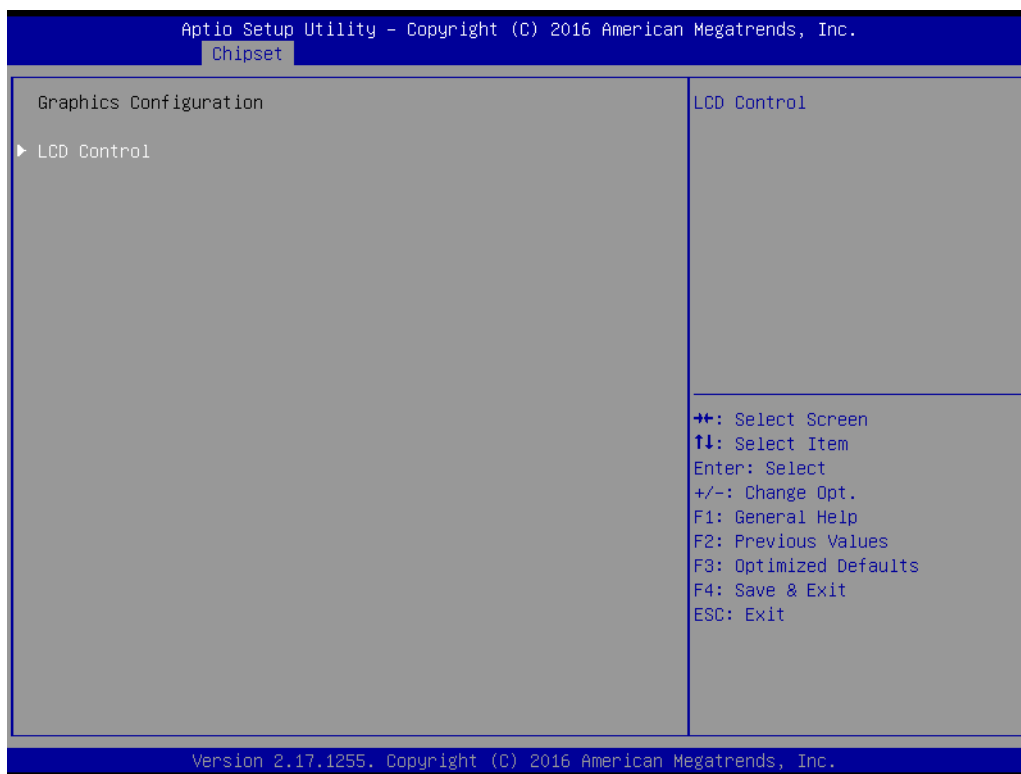

– LCD Control

This item allows customers to performs LCD control.

LCD Control

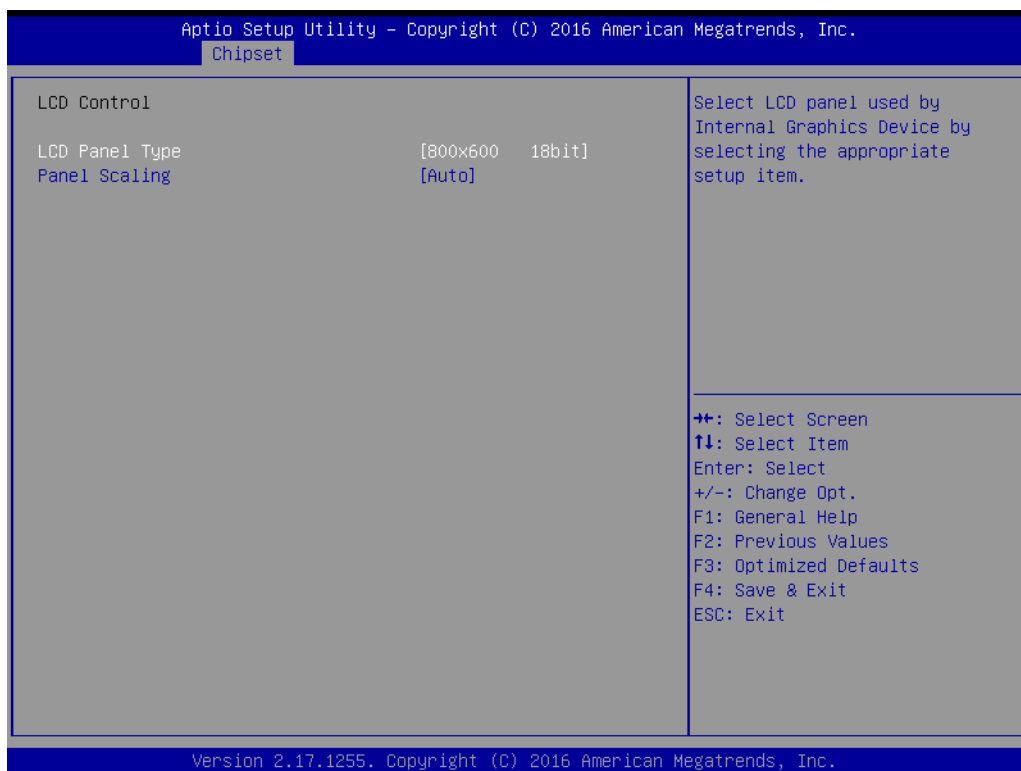

LCD Panel Type

Select an LCD panel used by Internal Graphics Device by selecting the appropriate setup item.

Panel Scaling

Select an LCD panel used by internal graphics device.

■ Memory Configuration

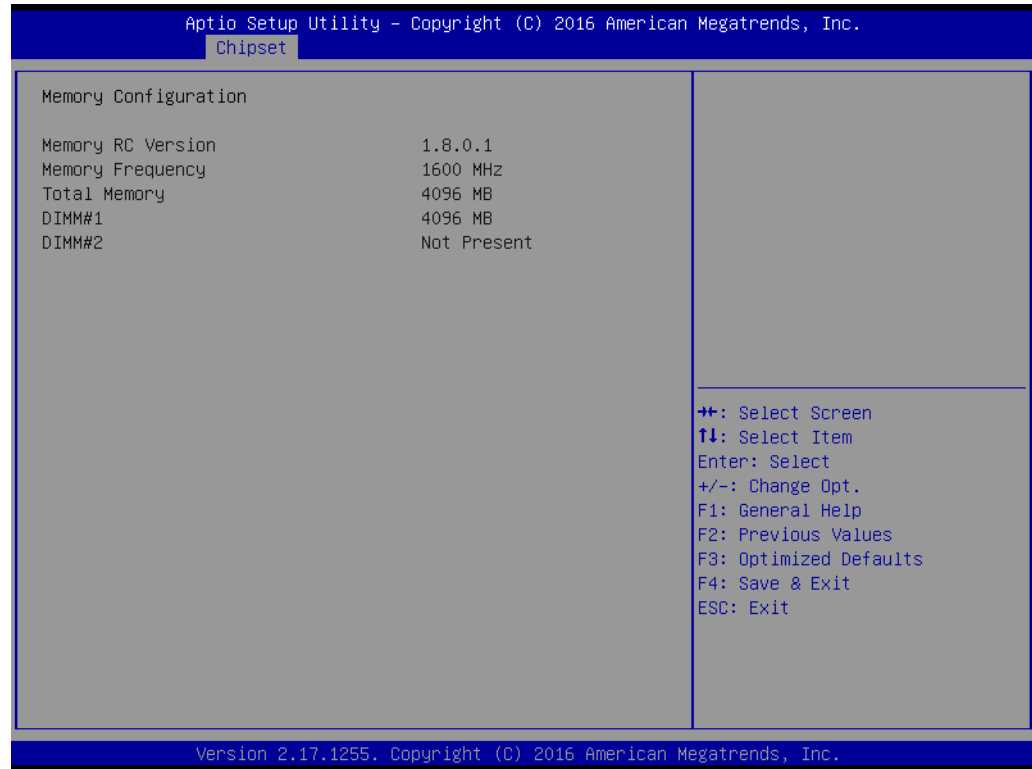

3.1.3.2 PCH-IO Configuration

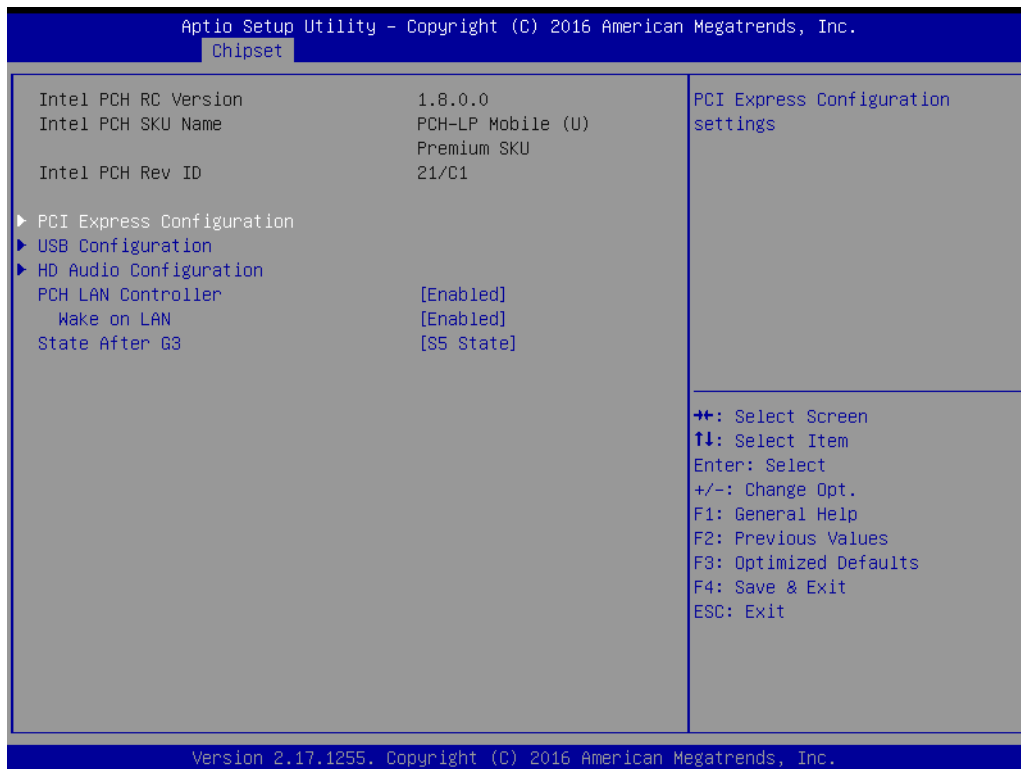

- **PCI Express Configuration**
PCI Express configuration settings.
- **USB Configuration**
USB Configuration settings.
- **HD Audio Configuration**
HD Audio subsystem configuration settings.
- **PCH LAN Controller**
Enable or disable onboard NIC.
- **Wake on LAN**
Enable or disable integrated LAN to wake the system. (The wake on LAN cannot be disabled if ME is on at Sx state.)
- **State After G3**
Specify what state to go to when power is re-applied after a power failure (G3 state).

■ PCI Express Configuration

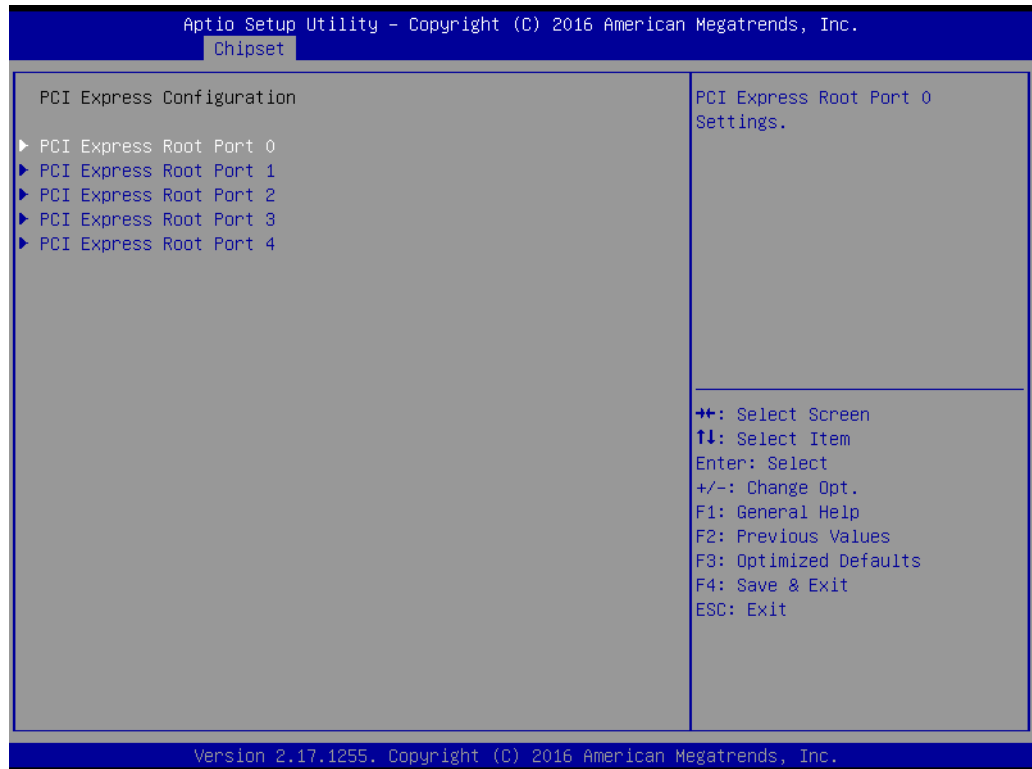

- **PCI Express Root Port 0**
PCI Express Root Port 0 settings.
- **PCI Express Root Port 1**
PCI Express Root Port 1 settings.
- **PCI Express Root Port 2**
PCI Express Root Port 2 settings.
- **PCI Express Root Port 4**
PCI Express Root Port 4 settings.

– PCI Express Root Port 0

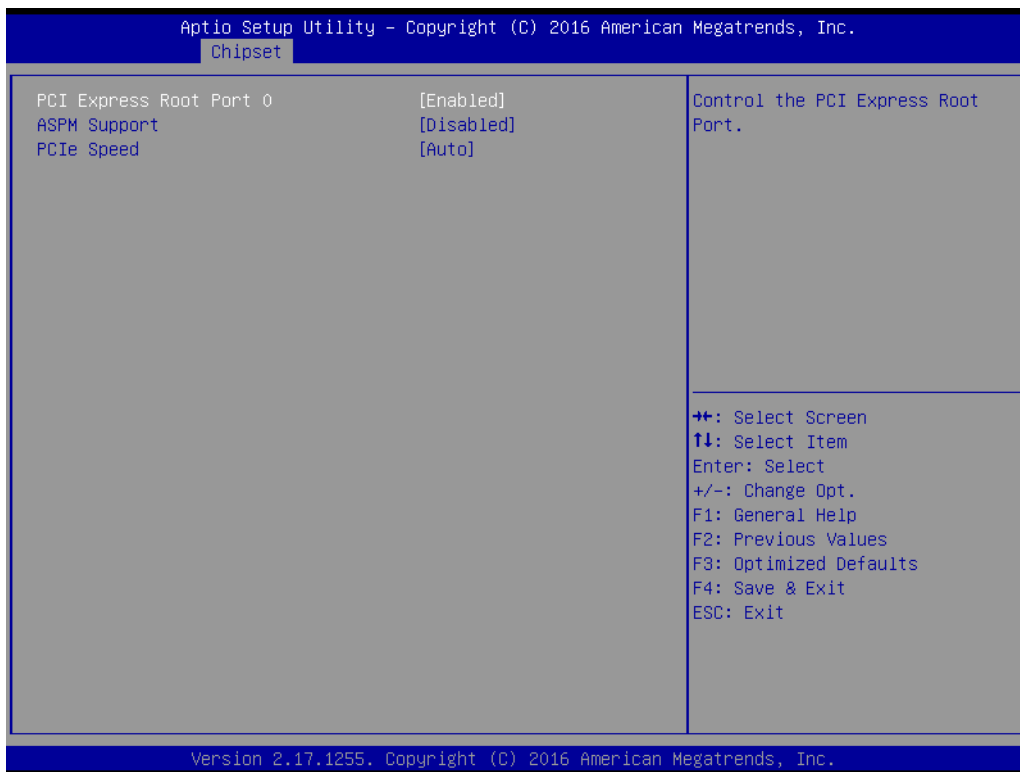

PCI Express Root Port 0

Control the PCI Express Root Port.

ASPM Support

Set the ASPM level: Force L0s – Force all links to L0s state.

Auto – BIOS auto configure

Disable – disable ASPM.

PCIe Speed

Select PCI Express port speed.

– PCI Express Root Port 1

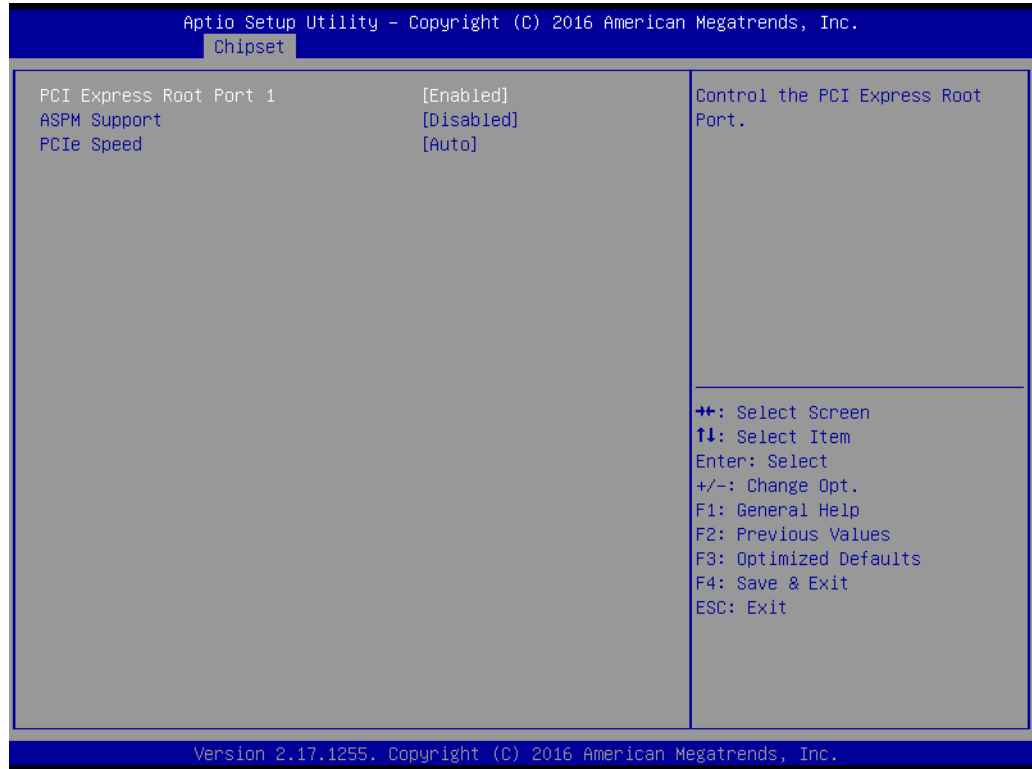

PCI Express Root Port 1

Control the PCI Express Root Port.

ASPM Support

Set the ASPM level: Force L0s – Force all links to L0s state.

Auto – BIOS auto configure

Disable – disable ASPM.

PCIe Speed

Select PCI Express port speed.

– PCI Express Root Port 2

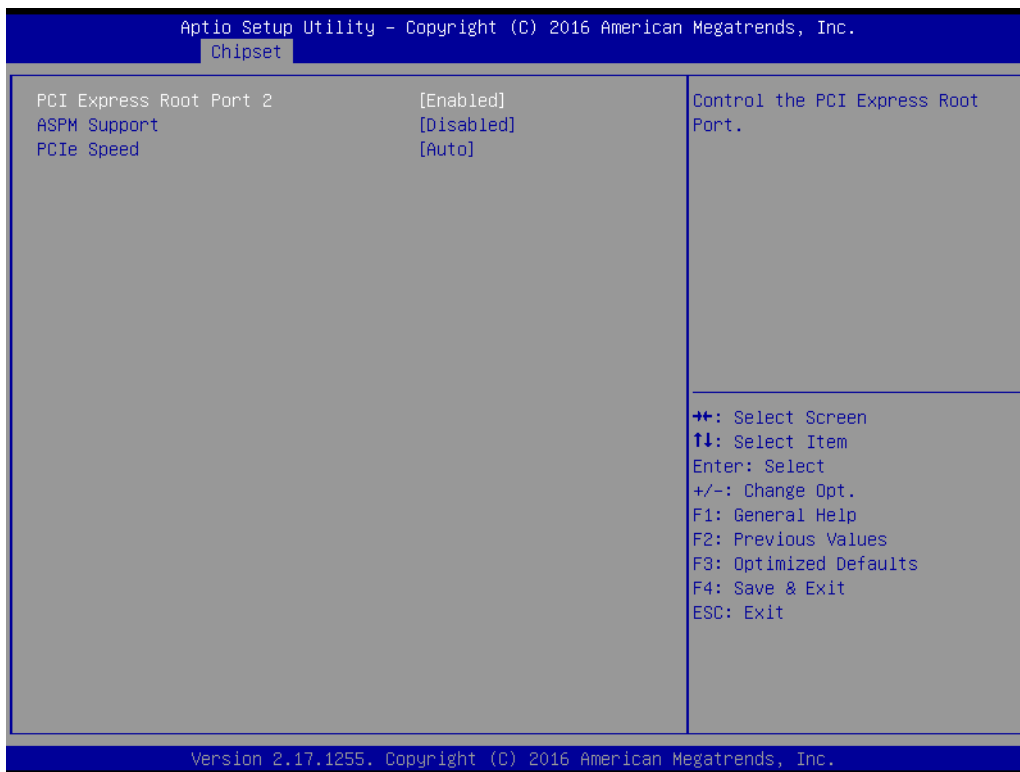

PCI Express Root Port 2

This item allows users to enable or disable PCI Express Root Port.

ASPM

This item allows users to select PCI Express Active State Power Management settings.

PCIe Speed

This item allows users to select PCIe Speed.

Detect Non-Compliance Device

Detect Non-Compliance Device PCI Express Device. If enabled, it will take more time during POST.

– PCI Express Root Port 3

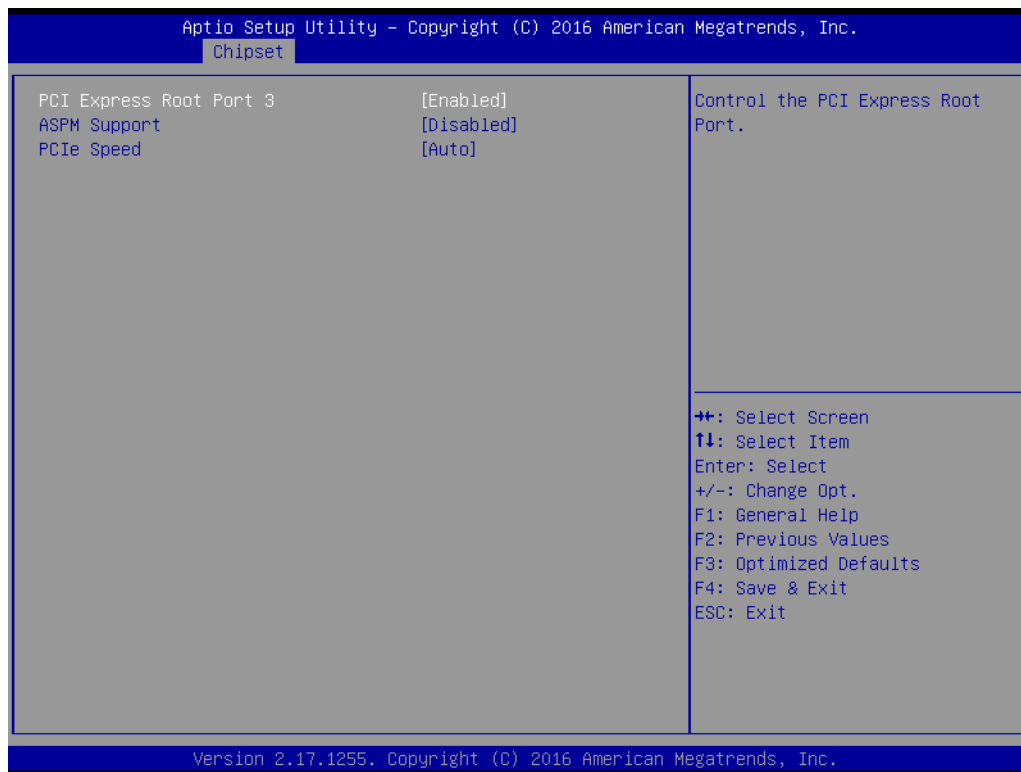

PCI Express Root Port 3

Controls the PCI Express Root Port.

ASPM Support

Set the ASPM level: Force L0s - Force all links to L0s state.

Auto - BIOS auto configure

Disable - disables ASPM.

PCIe Speed

Select PCI Express port speed.

– PCI Express Root Port 4

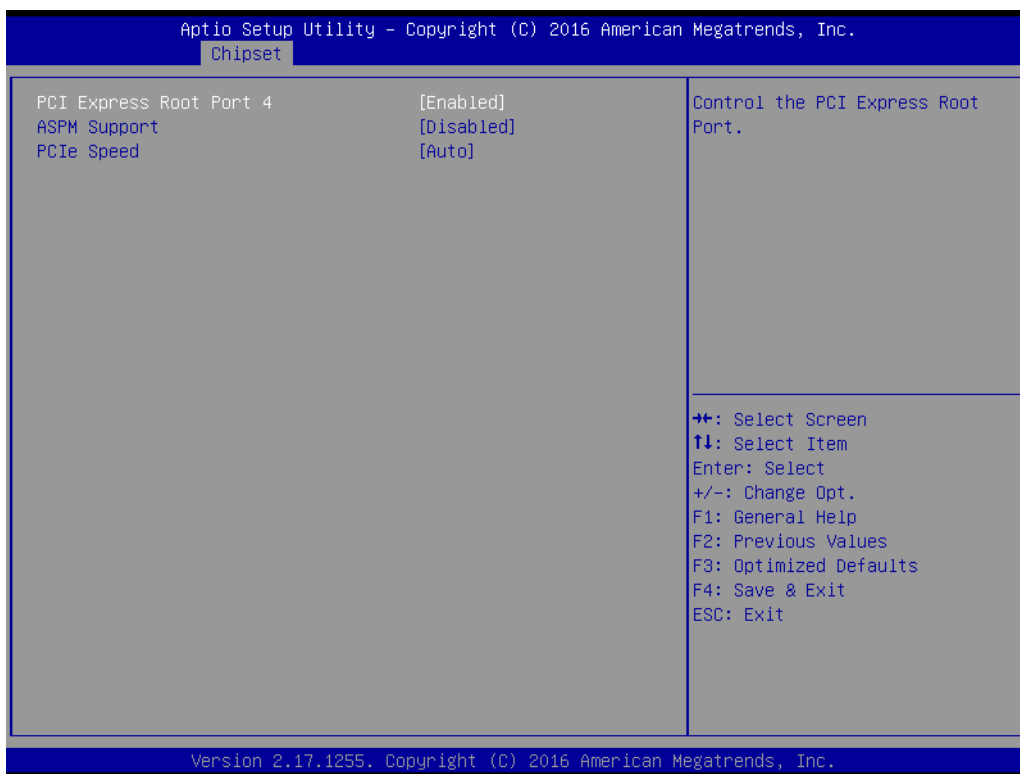

PCI Express Root Port 4

Controls the PCI Express Root Port.

ASPM Support

Set the ASPM level: Force L0s - Force all links to L0s state.

Auto - BIOS auto configure

Disable - disable ASPM.

PCIe Speed

Select PCI Express port speed.

■ USB Configuration



– XHCI Disable Compliance Mode

Options to disable compliance mode. Default is FALSE which does not disable compliance mode. Set TRUE to disable compliance mode.

■ HD Audio Configuration

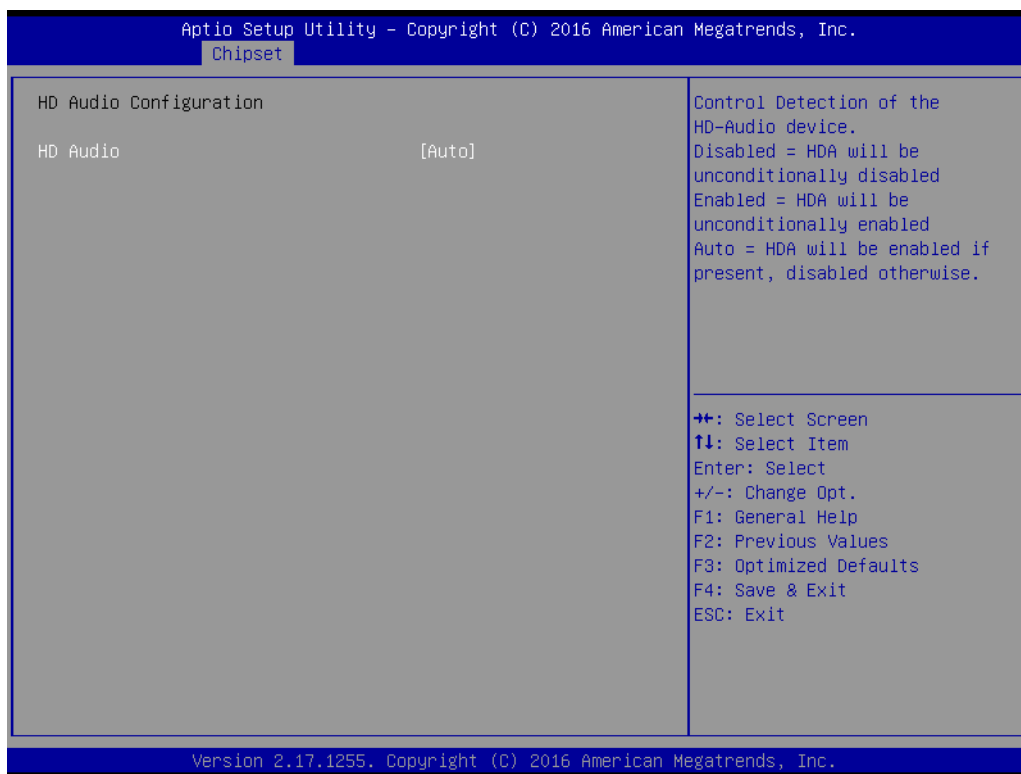

– HD Audio

Control detection of the HD-Audio device.

Disable = HDA will be unconditionally disabled.

Enable = HDA will be unconditionally enabled.

Auto = HDA will be enabled if present, disabled otherwise.

3.1.4 Security Setting

Select Security Setup from the SOM-6897 Setup main BIOS setup menu. All Security Setup options, such as password protection is described in this section. To access the sub menu for the following items, select the item and press <Enter>:

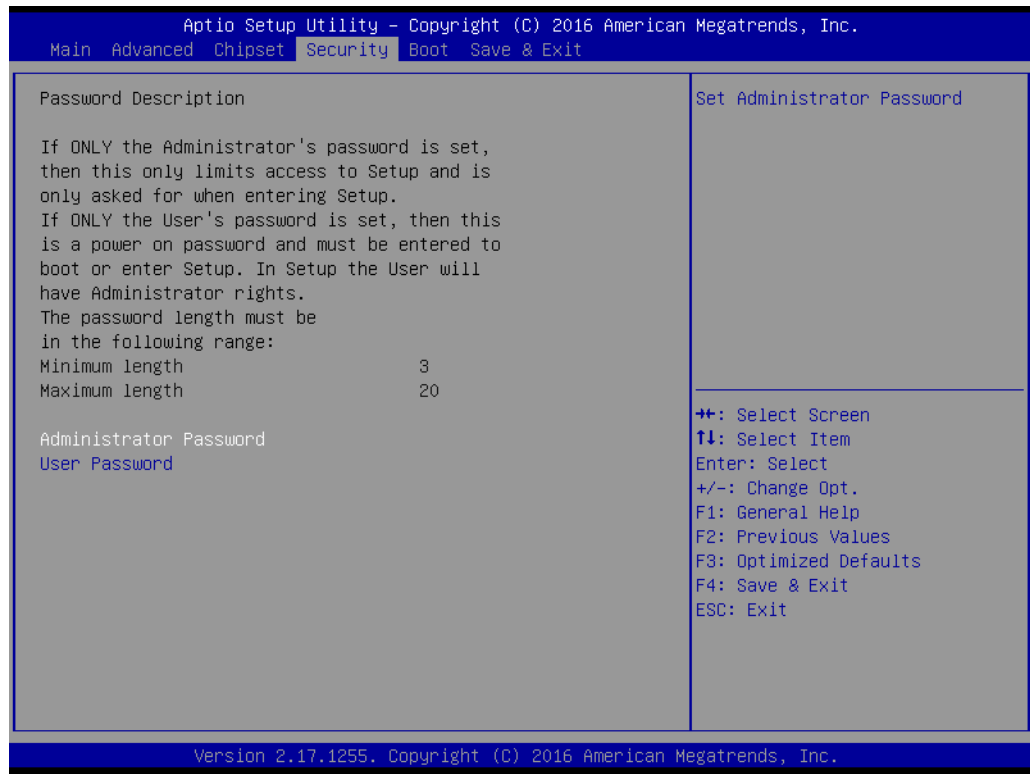

Change Administrator / User Password: Select this option and press <ENTER> to access the sub menu, and then type in the password.

3.1.5 Boot Settings

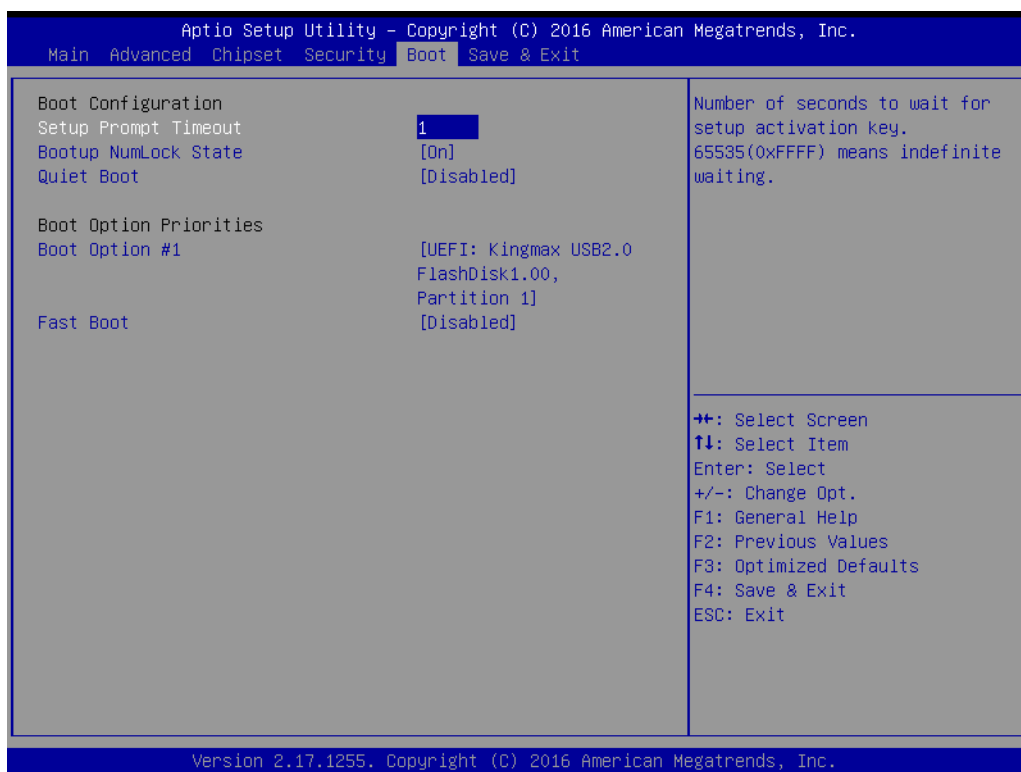

- **Setup Prompt Timeout**
This item allows users to select the number of seconds to wait for setup activation key. 65535 (0xFFFF) means indefinite waiting.
- **Bootup NumLock State**
This item allows users to select the keyboard Numlock state.
- **Quiet Boot**
This item allows users to enable or disable quiet boot option.
- **Boot Option #1**
Sets the system boot order.
- **Fast Boot**
This item allows users to enable or disable boot with initialization of a minimal set of devices required to launch active boot option. Has no effect for BBS boot options.

3.1.6 Save & Exit

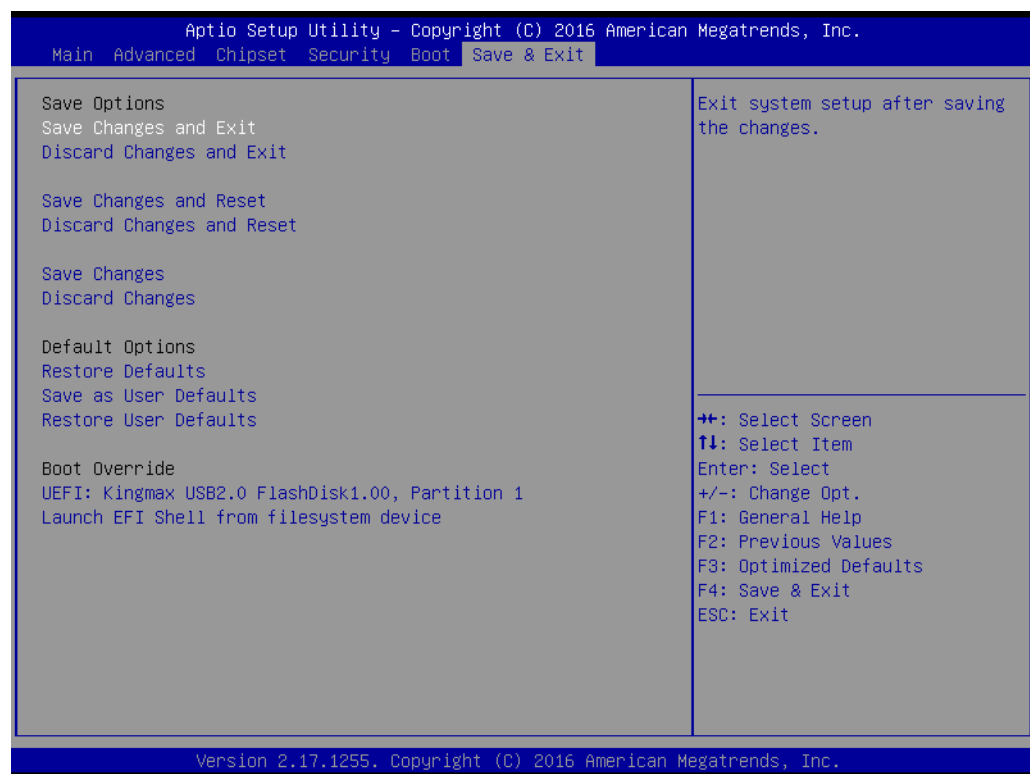

3.1.6.1 Save Changes and Exit

When users have completed system configuration, select this option to save changes, exit BIOS setup menu and reboot the computer if necessary to take effect all system configuration parameters.

3.1.6.2 Discard Changes and Exit

Select this option to quit Setup without making any permanent changes to the system configuration.

3.1.6.3 Save Changes and Reset

When users have completed system configuration, select this option to save changes, exit BIOS setup menu and reboot the computer to take effect on all system configuration parameters.

3.1.6.4 Discard Changes and Reset

Select this option to quit Setup without making any permanent changes to the system configuration and reboot the computer.

3.1.6.5 Save Changes

When users have completed system configuration, select this option to save changes without exit BIOS setup menu.

3.1.6.6 Discard Changes

Select this option to discard any current changes and load previous system configuration.

3.1.6.7 Restore Defaults

The SOM-6897 automatically configures all setup items to optimal settings when users select this option. Optimal Defaults are designed for maximum system performance, but may not work best for all computer applications. In particular, do not use the Optimal Defaults if the user's computer is experiencing system configuration problems.

3.1.6.8 Save User Defaults

When users have completed system configuration, select this option to save changes as user defaults without exit BIOS setup menu.

3.1.6.9 Restore User Defaults

The users can select this option to restore user defaults.

3.1.6.10 Windows Boot Manager (P0: WDC WD5000AAKX-00ERMA0)

3.1.6.11 Launch EFI Shell from file system device

This items attempts to Launch EFI Shell application (Shell.efi) from one of the available file system devices.

Chapter 4

S/W Introduction & Installation

Sections include:

- S/W Introduction
- Driver Installation
- Advantech iManager

4.1 S/W Introduction

The mission of Advantech Embedded Software Services is to "Enhance quality of life with Advantech platforms and Microsoft Windows embedded technology." We enable Windows Embedded software products on Advantech platforms to more effectively support the embedded computing community. Customers are freed from the hassle of dealing with multiple vendors (Hardware suppliers, System integrators, Embedded OS distributor) for projects. Our goal is to make Windows Embedded Software solutions easily and widely available to the embedded computing community.

4.2 Driver Installation

The Intel Chipset Software Installation (CSI) utility installs the Windows INF files that outline to the operating system how the chipset components will be configured.

4.2.1 Windows Driver Setup

To install the drivers on a windows-based OS, please connect to the internet and go to <http://support.advantech.com.tw> to download the drivers that you want to install and follow Driver Setup instructions to complete the installation.











4.2.2 Other OS

To install the drivers for Linux or other OS, please connect to the internet and go to <http://support.advantech.com.tw> to download the setup file.

4.3 Advantech iManager

Advantech's platforms come equipped with iManager, a micro controller that provides embedded features for system integrators. Embedded features have been moved from the OS/BIOS level to the board level, to increase reliability and simplify integration.

iManager runs whether the operating system is running or not; it can count the boot times and running hours of the device, monitor device health, and provide an advanced watchdog to handle errors as they happen. iManager also comes with a secure & encrypted EEPROM for storing important security keys or other customer information. All the embedded functions are configured through the API and provide corresponding utilities to demonstrate. These APIs comply with PICMG EAPI (Embedded Application Programmable Interface) specifications and makes these embedded features easier to integrate, speed development schedules, and provide customer's with software continuity while upgrading hardware. More details of how to use the APIs and utilities, please refer to the Advantech iManager 2.0 Software API User Manual.

Control	Monitor
 <p>GPIO</p> <p>General Purpose Input/Output is a flexible parallel interface that allows a variety of custom connections. It allows users to monitor the level of signal input or set the output status to switch on/off a device. Our API also provides Programmable GPIO, which allows developers to dynamically set the GPIO input or output status.</p>	 <p>Watchdog</p> <p>A watchdog timer (WDT) is a device that performs a specific operation after a certain period of time if something goes wrong and the system does not recover on its own. A watchdog timer can be programmed to perform a warm boot (restarting the system) after a certain number of seconds.</p>
 <p>SMBus</p> <p>SMBus is the System Management Bus defined by Intel® Corporation in 1995. It is used in personal computers and servers for low-speed system management communications. The SMBus API allows a developer to interface a embedded system environment and transfer serial messages using the SMBus protocols, allowing multiple simultaneous device control.</p>	 <p>Hardware Monitor</p> <p>The Hardware Monitor (HWM) API is a system health supervision API that inspects certain condition indexes, such as fan speed, temperature and voltage.</p>
 <p>I2C</p> <p>I2C is a bi-directional two wire bus that was developed by Philips for use in their televisions in the 1980s. The I2C API allows a developer to interface with an embedded system environment and transfer serial messages using the I2C protocols, allowing multiple simultaneous device control.</p>	 <p>Hardware Control</p> <p>The Hardware Control API allows developers to set the PWM (Pulse Width Modulation) value to adjust fan speed or other devices; it can also be used to adjust the LCD brightness.</p>
Display	Power Saving
 <p>Brightness Control</p> <p>The Brightness Control API allows a developer to interface with an embedded device to easily control brightness.</p>	 <p>CPU Speed</p> <p>Make use of Intel SpeedStep technology to reduce power consumption. The system will automatically adjust the CPU Speed depending on system loading.</p>
 <p>Backlight</p> <p>The Backlight API allows a developer to control the backlight (screen) on/off in an embedded device.</p>	 <p>System Throttling</p> <p>Refers to a series of methods for reducing power consumption in computers by lowering the clock frequency. These APIs allow the user to lower the clock from 67.5% to 12.5%.</p>

Appendix **A**

Pin Assignment

This appendix gives you the information about the hardware pin assignment of the SOM-6897 CPU System on Module.

Sections include:

- SOM-6897 Type 6 Pin Assignment

A.1 SOM-6897 Type 6 Pin Assignment

This section gives SOM-6897 pin assignment on COM Express connector which compliant with COMR.0 R2.1 Type 6 pin-out definitions. More details about how to use these pins and get design reference, please contact to Advantech for design guides, checklists, reference schematics, and other hardware/software support.

SOM-6897 Row A,B			
A1	GND (FIXED)	B1	GND (FIXED)
A2	GBE0_MDI3-	B2	GBE0_ACT#
A3	GBE0_MDI3+	B3	LPC_FRAME#
A4	GBE0_LINK100#	B4	LPC_AD0
A5	GBE0_LINK1000#	B5	LPC_AD1
A6	GBE0_MDI2-	B6	LPC_AD2
A7	GBE0_MDI2+	B7	LPC_AD3
A8	GBE0_LINK#	B8	N/A
A9	GBE0_MDI1-	B9	N/A
A10	GBE0_MDI1+	B10	LPC_CLK
A11	GND (FIXED)	B11	GND (FIXED)
A12	GBE0_MDI0-	B12	PWRBTN#
A13	GBE0_MDI0+	B13	SMB_CK
A14	N/A	B14	SMB_DAT
A15	SUS_S3#	B15	SMB_ALERT#
A16	SATA0_TX+	B16	SATA1_TX+
A17	SATA0_TX-	B17	SATA1_TX-
A18	SUS_S4#	B18	SUS_STAT#
A19	SATA0_RX+	B19	SATA1_RX+
A20	SATA0_RX-	B20	SATA1_RX-
A21	GND (FIXED)	B21	GND (FIXED)
A22	SATA2_TX+	B22	SATA3_TX+
A23	SATA2_TX-	B23	SATA3_TX-
A24	SUS_S5#	B24	PWR_OK
A25	SATA2_RX+	B25	SATA3_RX+
A26	SATA2_RX-	B26	SATA3_RX-
A27	BATLOW#	B27	WDT
A28	(S)ATA_ACT#	B28	AC/HDA_SDIN2
A29	AC/HDA_SYNC	B29	AC/HDA_SDIN1
A30	AC/HDA_RST#	B30	AC/HDA_SDIN0
A31	GND (FIXED)	B31	GND (FIXED)
A32	AC/HDA_BITCLK	B32	SPKR
A33	AC/HDA_SDOUT	B33	I2C_CK
A34	BIOS_DIS0#	B34	I2C_DAT
A35	THRMTRIP#	B35	THRM#
A36	USB6-	B36	USB7-
A37	USB6+	B37	USB7+
A38	USB_6_7_OC#	B38	USB_4_5_OC#
A39	USB4-	B39	USB5-
A40	USB4+	B40	USB5+
A41	GND (FIXED)	B41	GND (FIXED)

A42	USB2-	B42	USB3-
A43	USB2+	B43	USB3+
A44	USB_2_3_OC#	B44	USB_0_1_OC#
A45	USB0-	B45	USB1-
A46	USB0+	B46	USB1+
A47	VCC_RTC	B47	EXCD1_PERST#
A48	EXCD0_PERST#	B48	EXCD1_CPPE#
A49	EXCD0_CPPE#	B49	SYS_RESET#
A50	LPC_SERIRQ	B50	CB_RESET#
A51	GND (FIXED)	B51	GND (FIXED)
A52	PCIE_TX5+	B52	PCIE_RX5+
A53	PCIE_TX5-	B53	PCIE_RX5-
A54	GPIO	B54	GPO1
A55	PCIE_TX4+	B55	PCIE_RX4+
A56	PCIE_TX4-	B56	PCIE_RX4-
A57	GND	B57	GPO2
A58	PCIE_TX3+ (if C25 stuffed)	B58	PCIE_RX3+ (if R545 stuffed)
A59	PCIE_TX3- (if C24 stuffed)	B59	PCIE_RX3- (if R546 stuffed)
A60	GND (FIXED)	B60	GND (FIXED)
A61	PCIE_TX2+	B61	PCIE_RX2+
A62	PCIE_TX2-	B62	PCIE_RX2-
A63	GPI1	B63	GPO3
A64	PCIE_TX1+	B64	PCIE_RX1+
A65	PCIE_TX1-	B65	PCIE_RX1-
A66	GND	B66	WAKE0#
A67	GPI2	B67	WAKE1#
A68	PCIE_TX0+	B68	PCIE_RX0+
A69	PCIE_TX0-	B69	PCIE_RX0-
A70	GND (FIXED)	B70	GND (FIXED)
A71	LVDS_A0+	B71	LVDS_B0+
A72	LVDS_A0-	B72	LVDS_B0-
A73	LVDS_A1+	B73	LVDS_B1+
A74	LVDS_A1-	B74	LVDS_B1-
A75	LVDS_A2+	B75	LVDS_B2+
A76	LVDS_A2-	B76	LVDS_B2-
A77	LVDS_VDD_EN	B77	LVDS_B3+
A78	LVDS_A3+	B78	LVDS_B3-
A79	LVDS_A3-	B79	LVDS_BKLT_EN
A80	GND (FIXED)	B80	GND (FIXED)
A81	LVDS_A_CK+	B81	LVDS_B_CK+
A82	LVDS_A_CK-	B82	LVDS_B_CK-
A83	LVDS_I2C_CK	B83	LVDS_BKLT_CTRL
A84	LVDS_I2C_DAT	B84	VCC_5V_SBY
A85	GPI3	B85	VCC_5V_SBY
A86	RSVD(KBD_RST# if R472 stuffed)	B86	VCC_5V_SBY
A87	N/A	B87	VCC_5V_SBY
A88	PCIE_CLK_REF+	B88	BIOS_DIS1#
A89	PCIE_CLK_REF-	B89	VGA_RED

A90	GND (FIXED)	B90	GND (FIXED)
A91	SPI_POWER	B91	VGA_GRN
A92	SPI_MISO	B92	VGA_BLU
A93	GPO0	B93	VGA_HSYNC
A94	SPI_CLK	B94	VGA_VSYNC
A95	SPI_MOSI	B95	VGA_I2C_CK
A96	N/A	B96	VGA_I2C_DAT
A97	TYPE10#	B97	SPI_CS#
A98	SER0_TX	B98	RSVD
A99	SER0_RX	B99	RSVD
A100	GND (FIXED)	B100	GND (FIXED)
A101	SER1_TX	B101	FAN_PWMOUT
A102	SER1_RX	B102	FAN_TACHIN
A103	LID#	B103	SLEEP#
A104	VCC_12V	B104	VCC_12V
A105	VCC_12V	B105	VCC_12V
A106	VCC_12V	B106	VCC_12V
A107	VCC_12V	B107	VCC_12V
A108	VCC_12V	B108	VCC_12V
A109	VCC_12V	B109	VCC_12V
A110	GND (FIXED)	B110	GND (FIXED)
SOM-6897 Row C,D			
C1	GND (FIXED)	D1	GND (FIXED)
C2	GND	D2	GND
C3	USB_SSRX0-	D3	USB_SSTX0-
C4	USB_SSRX0+	D4	USB_SSTX0+
C5	GND	D5	GND
C6	USB_SSRX1-	D6	USB_SSTX1-
C7	USB_SSRX1+	D7	USB_SSTX1+
C8	GND	D8	GND
C9	N/A	D9	N/A
C10	N/A	D10	N/A
C11	GND (FIXED)	D11	GND (FIXED)
C12	N/A	D12	N/A
C13	N/A	D13	N/A
C14	GND	D14	GND
C15	N/A	D15	DDI1_CTRLCLK_AUX+
C16	N/A	D16	DDI1_CTRLDATA_AUX-
C17	RSVD	D17	RSVD
C18	RSVD	D18	RSVD
C19	N/A	D19	N/A
C20	N/A	D20	N/A
C21	GND (FIXED)	D21	GND (FIXED)
C22	N/A	D22	N/A
C23	N/A	D23	N/A
C24	DDI1_HPD	D24	RSVD
C25	N/A	D25	RSVD

C26	N/A	D26	DDI1_PAIR0+
C27	RSVD	D27	DDI1_PAIR0-
C28	RSVD	D28	RSVD
C29	N/A	D29	DDI1_PAIR1+
C30	N/A	D30	DDI1_PAIR1-
C31	GND (FIXED)	D31	GND (FIXED)
C32	DDI2_CTRLCLK_AUX+ (if R108 stuffed)	D32	DDI1_PAIR2+
C33	DDI2_CTRLCLK_AUX- (if R109 stuffed)	D33	DDI1_PAIR2-
C34	DDI2_DDC_AUX_SEL (if R108/R109 stuffed)	D34	DDI1_DDC_AUX_SEL
C35	RSVD	D35	RSVD
C36	N/A	D36	DDI1_PAIR3+
C37	N/A	D37	DDI1_PAIR3-
C38	N/A	D38	RSVD
C39	N/A	D39	DDI2_PAIR0+ (if R6 stuffed)
C40	N/A	D40	DDI2_PAIR0- (if R5 stuffed)
C41	GND (FIXED)	D41	GND (FIXED)
C42	N/A	D42	DDI2_PAIR1+ (if R8 stuffed)
C43	N/A	D43	DDI2_PAIR1- (if R7 stuffed)
C44	N/A	D44	DDI2_HPDP (if R544 stuffed)
C45	RSVD	D45	RSVD
C46	N/A	D46	DDI2_PAIR2+ (if R5/R6/R7/R8 stuffed)
C47	N/A	D47	DDI2_PAIR2- (if R5/R6/R7/R8 stuffed)
C48	RSVD	D48	RSVD
C49	N/A	D49	DDI2_PAIR3+ (if R5/R6/R7/R8 stuffed)
C50	N/A	D50	DDI2_PAIR3- (if R5/R6/R7/R8 stuffed)
C51	GND (FIXED)	D51	GND (FIXED)
C52	PCIE_RX16+ (if R140 stuffed)	D52	PCIE_TX16+ (if C13 stuffed)
C53	PCIE_RX16- (if R139 stuffed)	D53	PCIE_TX16- (if C12 stuffed)
C54	TYPE0#	D54	N/A
C55	PCIE_RX17+ (if R140/R139 stuffed)	D55	PCIE_TX17+ (if C13/C12 stuffed)
C56	PCIE_RX17- (if R140/R139 stuffed)	D56	PCIE_TX17- (if C13/C12 stuffed)
C57	TYPE1#	D57	TYPE2#
C58	PCIE_RX18+ (if R140/R139 stuffed)	D58	PCIE_TX18+ (if C13/C12 stuffed)
C59	PCIE_RX18- (if R140/R139 stuffed)	D59	PCIE_TX18- (if C13/C12 stuffed)
C60	GND (FIXED)	D60	GND (FIXED)
C61	PCIE_RX19+ (if R140/R139 stuffed)	D61	PCIE_TX19+ (if C13/C12 stuffed)
C62	PCIE_RX19- (if R140/R139 stuffed)	D62	PCIE_TX19- (if C13/C12 stuffed)
C63	RSVD	D63	RSVD

C64	RSVD	D64	RSVD
C65	N/A	D65	N/A
C66	N/A	D66	N/A
C67	RSVD	D67	GND
C68	N/A	D68	N/A
C69	N/A	D69	N/A
C70	GND (FIXED)	D70	GND (FIXED)
C71	N/A	D71	N/A
C72	N/A	D72	N/A
C73	GND	D73	GND
C74	N/A	D74	N/A
C75	N/A	D75	N/A
C76	GND	D76	GND
C77	RSVD	D77	RSVD
C78	N/A	D78	N/A
C79	N/A	D79	N/A
C80	GND (FIXED)	D80	GND (FIXED)
C81	N/A	D81	N/A
C82	N/A	D82	N/A
C83	RSVD	D83	RSVD
C84	GND	D84	GND
C85	N/A	D85	N/A
C86	N/A	D86	N/A
C87	GND	D87	GND
C88	N/A	D88	N/A
C89	N/A	D89	N/A
C90	GND (FIXED)	D90	GND (FIXED)
C91	N/A	D91	N/A
C92	N/A	D92	N/A
C93	GND	D93	GND
C94	N/A	D94	N/A
C95	N/A	D95	N/A
C96	GND	D96	GND
C97	RSVD	D97	N/A
C98	N/A	D98	N/A
C99	N/A	D99	N/A
C100	GND (FIXED)	D100	GND (FIXED)
C101	N/A	D101	N/A
C102	N/A	D102	N/A
C103	GND	D103	GND
C104	VCC_12V	D104	VCC_12V
C105	VCC_12V	D105	VCC_12V
C106	VCC_12V	D106	VCC_12V
C107	VCC_12V	D107	VCC_12V
C108	VCC_12V	D108	VCC_12V
C109	VCC_12V	D109	VCC_12V
C110	GND (FIXED)	D110	GND (FIXED)

Appendix **B**

Watchdog Timer

This appendix gives you the information about the watchdog timer programming on the SOM-6897 CPU System on Module.

Sections include:

- Watchdog Timer Programming

B.1 Programming the Watchdog Timer

Trigger Event	Note
IRQ	(BIOS setting default disable)**
NMI	N/A
SCI	Power button event
Power Off	Support
H/W Restart	Support
WDT Pin Activate	Support

** WDT new driver support automatically selects available IRQ number from BIOS, and then sets EC. Only Win XP, Win7 and Win8 supports it.

In other OS, it will still use IRQ number from BIOS setting as usual.

For details, please refer to *iManager & Software API User Manual*:

Appendix **C**

Programming GPIO

This Appendix gives the illustration of the General Purpose Input and Output pin setting.

Sections include:

- System I/O Ports

C.1 GPIO Register

GPIO Byte Mapping	H/W Pin Name
BIT0	GPO0
BIT1	GPO1
BIT2	GPO2
BIT3	GPO3
BIT4	GPI0
BIT5	GPI1
BIT6	GPI2
BIT7	GPI3

For details, please refer to *iManager & Software API User Manual*.

Appendix **D**

System Assignments

This appendix gives you the information about the system resource allocation on the SOM-6897 CPU System on Module.

Sections include:

- System I/O ports
- DMA Channel Assignments
- Interrupt Assignments
- Memory Map

D.1 System I/O Ports

Table D.1: System I/O ports

Addr.Range(Hex)	Device
0000-0CF7	PCI Express Root Complex
0020-0021	Programmable interrupt controller
0024-0025	Programmable interrupt controller
0028-0029	Programmable interrupt controller
002C-002D	Programmable interrupt controller
002E-002F	Motherboard resources
0030-0031	Programmable interrupt controller
0034-0035	Programmable interrupt controller
0038-0039	Programmable interrupt controller
003C-003D	Programmable interrupt controller
0040-0043	System timer
004E-004F	Motherboard resources
0050-0053	System timer
0060-0060	Standard PS/2 Keyboard
0061-0061	Motherboard resources
0062-0062	Microsoft ACPI-Compliant Embedded Controller
0063-0063	Motherboard resources
0064-0064	Standard PS/2 Keyboard
0065-0065	Motherboard resources
0066-0066	Microsoft ACPI-Compliant Embedded Controller
0067-0067	Motherboard resources
0070-0070	Motherboard resources
0070-0077	System CMOS/real time clock
0080-0080	Motherboard resources
0092-0092	Motherboard resources
00A0-00A1	Programmable interrupt controller
00A4-00A5	Programmable interrupt controller
00A8-00A9	Programmable interrupt controller
00AC-00AD	Programmable interrupt controller
00B0-00B1	Programmable interrupt controller
00B2-00B3	Motherboard resources
00B4-00B5	Programmable interrupt controller
00B8-00B9	Programmable interrupt controller
00BC-00BD	Programmable interrupt controller
029C-029D	Motherboard resources
02E8-02EF	Communications Port (COM4)
02F8-02FF	Communications Port (COM2)
0378-037F	Printer Port (LPT1)
03E8-03EF	Communications Port (COM3)
03F8-03FF	Communications Port (COM1)
04D0-04D1	Programmable interrupt controller
0680-069F	Motherboard resources
0778-077F	Printer Port (LPT1)

Table D.1: System I/O ports

0A00-0A0F	Motherboard resources
0A10-0A1F	Motherboard resources
0D00-FFFF	PCI Express Root Complex
164E-164F	Motherboard resources
1800-18FE	Motherboard resources
1854-1857	Motherboard resources
F000-F03F	Intel(R) HD Graphics 520
F040-F05F	Mobile 6th Generation Intel(R) Processor Family I/O SMBUS – 9D23
F060-F07F	Standard SATA AHCI Controller
F080-F083	Standard SATA AHCI Controller
F090-F097	Standard SATA AHCI Controller
FF00-FFFE	Motherboard resources
FFFF-FFFF	Motherboard resources

D.2 DMA Channel Assignments

Table D.2: DMA Channel Assignments

Channel	Function
3	Printer Port (LPT1)

D.3 Interrupt Assignments

Table D.3: Interrupt Assignments

Interrupt#	Interrupt Source
IRQ 0	System Timer
IRQ 1	Standard PS/2 Keyboard
IRQ 3	Communications Port (COM2)
IRQ 4	Communications Port (COM1)
IRQ 5	Communications Port (COM3)
IRQ 6	Communications Port (COM4)
IRQ 8	System CMOS/real time clock
IRQ 12	Microsoft PS/2 Mouse
IRQ 14	Motherboard resources
IRQ 11	Mobile 6th Generation Intel(R) Processor Family I/O Thermal sub-system – 9D31
IRQ 11	Mobile 6th Generation Intel(R) Processor Family I/O SMBUS – 9D23
IRQ 16	High Definition Audio Controller
IRQ 16	Standard SATA AHCI Controller
IRQ 81~511	Microsoft ACPI-Compliant System
IRQ FFFFFFFB (-5)	Intel(R) Management Engine Interface
IRQ FFFFFFFC (-4)	Intel(R) USB 3.0 eXtensible Host onroller

Table D.3: Interrupt Assignments

IRQ FFFFFFFD (-3)	Intel(R) HD Graphics 520
IRQ FFFFFFFE (-2)	Intel(R) I210 Ethernet Connection I219-LM

D.4 1st MB Memory Map

Table D.4: 1st MB Memory Map

Addr. Range (Hex)	Device
0x000A0000-0x000BFFFF	PCI Express Root Complex
0x90000000-0xDFFFFFFF	PCI Express Root Complex
0xC0000000-0xDEFFFFFF	Intel(R) HD Graphics 520
0xDE000000-0xCFFFFFFF	Intel(R) HD Graphics 520
0xDF000000-0xDF01FFFF	Intel(R) I210 Ethernet Connection I219-LM
0xDF020000-0xDF02FFFF	High Definition Audio Controller
0xDF030000-0xDF03FFFF	Intel(R) USB 3.0 eXtensible Host controller
0xDF040000-0xDF043FFF	High Definition Audio Controller
0xDF044000-0xDF047FFF	Mobile 6th Generation Intel(R) Processor Family I/O PMC - 9D21
0xDF048000-0xDF049FFF	Standard SATA AHCI Controller
0xDF04A000-0xDF04A0FF	Mobile 6th Generation Intel(R) Processor Family I/O SMBUS - 9D23
0xDF04B000-0xDF04B7FF	Standard SATA AHCI Controller
0xDF04C000-0xDF04C0FF	Standard SATA AHCI Controller
0xDF04E000-0xDF04EFFF	Mobile 6th Generation Intel(R) Processor Family I/O Thermal subsystem - 9D31
0xDFFE0000-0xDFFFFFFF	Motherboard resources
0xE0000000-0xEFFFFFFF	Motherboard resources
0xFD000000-0xFDABFFFF	Motherboard resources
0xFD000000-0xFE77FFFF	PCI Express Root Complex
0xFDAC0000-0xFDACFFFF	Motherboard resources
0xFDAD0000-0xFDADFFFF	Motherboard resources
0xFDAE0000-0xFDAEFFFF	Motherboard resources
0xFDAF0000-0xFDAFFFFF	Motherboard resources
0xFDB00000-0xFDFFFFFF	Motherboard resources
0xFE000000-0xFE01FFFF	Motherboard resources
0xFE028000-0xFE028FFF	Motherboard resources
0xFE028000-0xFE028FFF	Motherboard resources
0xFE029000-0xFE029FFF	Motherboard resources
0xFE036000-0xFE03BFFF	Motherboard resources
0xFE03D000-0xFE03FFFF	Motherboard resources
0xFE40F000-0xFE40FFFF	Intel(R) Management Engine Interface
0xFE410000-0xFE47FFFF	Motherboard resources
0xFED00000-0xFED003FF	High precision event timer
0xFED00000-0xFED003FF	Motherboard resources
0xFED00000-0xFED003FF	0xFED00000-0xFED003FF
0xFED10000-0xFED17FFF	Motherboard resources

Table D.4: 1st MB Memory Map	
0xFED18000-0xFED18FFF	Motherboard resources
0xFED19000-0xFED19FFF	Motherboard resources
0xFED20000-0xFED3FFFF	Motherboard resources
0xFED45000-0xFED8FFFF	Motherboard resources
0xFED90000-0xFED93FFF	Motherboard resources
0xFEE00000-0xFEEFFFFFFF	Motherboard resources
0xFF000000-0xFFFFFFFF	Intel(R) 82802 Firmware Hub Device
0xFF000000-0xFFFFFFFF	Motherboard resources

ADVANTECH

Enabling an Intelligent Planet

www.advantech.com

Please verify specifications before quoting. This guide is intended for reference purposes only.

All product specifications are subject to change without notice.

No part of this publication may be reproduced in any form or by any means, electronic, photocopying, recording or otherwise, without prior written permission of the publisher.

All brand and product names are trademarks or registered trademarks of their respective companies.

© Advantech Co., Ltd. 2018