



User Manual

SOM-6883

CPU Computer on Module

ADVANTECH

Enabling an Intelligent Planet

Copyright

The documentation and the software included with this product are copyrighted 2021 by Advantech Co., Ltd. All rights are reserved. Advantech Co., Ltd. reserves the right to make improvements in the products described in this manual at any time without notice. No part of this manual may be reproduced, copied, translated or transmitted in any form or by any means without the prior written permission of Advantech Co., Ltd. Information provided in this manual is intended to be accurate and reliable. However, Advantech Co., Ltd. assumes no responsibility for its use, nor for any infringements of the rights of third parties, which may result from its use.

Acknowledgments

AMD is a trademark of the AMD Corporation.

Microsoft Windows and MS-DOS are registered trademarks of Microsoft Corp.

All other product names or trademarks are properties of their respective owners.

Product Warranty (2 years)

Advantech warrants to you, the original purchaser, that each of its products will be free from defects in materials and workmanship for two years from the date of purchase.

This warranty does not apply to any products which have been repaired or altered by persons other than repair personnel authorized by Advantech, or which have been subject to misuse, abuse, accident or improper installation. Advantech assumes no liability under the terms of this warranty as a consequence of such events.

Because of Advantech's high quality-control standards and rigorous testing, most of our customers never need to use our repair service. If an Advantech product is defective, it will be repaired or replaced at no charge during the warranty period. For out-of-warranty repairs, you will be billed according to the cost of replacement materials, service time and freight. Please consult your dealer for more details.

If you think you have a defective product, follow these steps:

1. Collect all the information about the problem encountered. (For example, CPU speed, Advantech products used, other hardware and software used, etc.) Note anything abnormal and list any onscreen messages you get when the problem occurs.
2. Call your dealer and describe the problem. Please have your manual, product, and any helpful information readily available.
3. If your product is diagnosed as defective, obtain a return merchandise authorization (RMA) number from your dealer. This allows us to process your return more quickly.
4. Carefully pack the defective product, a fully-completed Repair and Replacement Order Card and a photocopy proof of purchase date (such as your sales receipt) in a shippable container. A product returned without proof of the purchase date is not eligible for warranty service.
5. Write the RMA number visibly on the outside of the package and ship it prepaid to your dealer.

Declaration of Conformity

CE

This product has passed the CE test for environmental specifications when shielded cables are used for external wiring. We recommend the use of shielded cables. This type of cable is available from Advantech. Please contact your local supplier for ordering information.

Test conditions for passing also include operating the equipment within an industrial enclosure. In order to protect the product from damage caused by electrostatic discharge (ESD) and EMI leakage, we strongly recommend the use of CE-compliant industrial enclosure products.

FCC Class B

This equipment has been tested and found to comply with the limits for a Class B digital device, pursuant to part 15 of the FCC Rules. These limits are designed to provide reasonable protection against harmful interference in a residential installation. This equipment generates, uses, and can radiate radio frequency energy and, if not installed and used in accordance with the instruction manual, may cause harmful interference to radio communications. However, there is no guarantee that interference will not occur in a particular installation. If this equipment does cause harmful interference to radio or television reception, which can be determined by turning the equipment off and on, the user is encouraged to try to correct the interference by one or more of the following measures:

- Reorient or relocate the receiving antenna
- Increase the separation between the equipment and receiver
- Connect the equipment to an outlet on a circuit different from that to which the receiver is connected
- Consult the dealer or an experienced radio/TV technician for assistance

FM

This equipment has passed the FM certification. According to the National Fire Protection Association, work sites are classified into different classes, divisions and groups, based on hazard considerations. This equipment is compliant with the specifications of Class I, Division 2, Groups A, B, C, and D indoor hazards.

Technical Support and Assistance

1. Visit the Advantech website at <http://support.advantech.com> to find the latest product information.
2. Contact your distributor, sales representative, or Advantech's customer service center for technical support if you need additional assistance. Please have the following information ready before you call:
 - Product name and serial number
 - Description of your peripheral attachments
 - Description of your software (operating system, version, application software, etc.)
 - A complete description of the problem
 - The exact wording of any error messages

Warnings, Cautions, and Notes

Warning! Warnings indicate conditions, which if not observed, that can cause personal injury!



Caution! Cautions should be noted to avoid damaging hardware or losing data. e.g.



There is a danger of a new battery exploding if it is incorrectly installed. Do not attempt to recharge, force open, or heat the battery. Replace the battery only with the same or equivalent type recommended by the manufacturer. Discard used batteries according to the manufacturer's instructions.

Note! Notes provide optional additional information.



Document Feedback

To assist us in making improvements to this manual, we welcome comments and constructive criticism. Please send all such in writing to: support@advantech.com

Safety Precaution — Static Electricity

Follow these simple precautions to protect yourself from harm and the products from damage:

- To avoid electrical shock, always disconnect the power from your PC chassis before you work on it. Don't touch any components on the CPU card or other cards while the PC is on.
- Disconnect power before making any configuration changes. The sudden rush of power as you connect a jumper or install a card may damage sensitive electronic components.

Safety Instructions

1. Read these safety instructions carefully.
2. Keep this User Manual for later reference.
3. Disconnect this equipment from any AC outlet before cleaning. Use a damp cloth. Do not use liquid or spray detergents for cleaning.
4. For plug-in equipment, the power outlet socket must be located near the equipment and must be easily accessible.
5. Keep this equipment away from humidity.
6. Put this equipment on a reliable surface during installation. Dropping it or letting it fall may cause damage.
7. The openings on the enclosure are for air convection. Protect the equipment from overheating. **DO NOT COVER THE OPENINGS.**
8. Make sure the voltage of the power source is correct before connecting the equipment to the power outlet.
9. Position the power cord so that people cannot step on it. Do not place anything over the power cord.
10. All cautions and warnings on the equipment should be noted.
11. If the equipment is not used for a long time, disconnect it from the power source to avoid damage by transient overvoltage.
12. Never pour any liquid into an opening. This may cause fire or electrical shock.
13. Never open the equipment. For safety reasons, the equipment should be opened only by qualified service personnel.
14. If one of the following situations arises, get the equipment checked by service personnel:
 - The power cord or plug is damaged
 - Liquid has penetrated into the equipment
 - The equipment has been exposed to moisture
 - The equipment does not work well, or you cannot get it to work according to the user's manual
 - The equipment has been dropped and damaged
 - The equipment has obvious signs of breakage
15. **DO NOT LEAVE THIS EQUIPMENT IN AN ENVIRONMENT WHERE THE STORAGE TEMPERATURE MAY DROP BELOW -20 °C (-4 °F) OR RISE ABOVE 60 °C (140 °F). THIS COULD DAMAGE THE EQUIPMENT. THE EQUIPMENT SHOULD BE KEPT IN A CONTROLLED ENVIRONMENT.**
16. **CAUTION: DANGER OF EXPLOSION IF BATTERY IS INCORRECTLY REPLACED. REPLACE ONLY WITH THE SAME OR EQUIVALENT TYPE RECOMMENDED BY THE MANUFACTURER, DISCARD USED BATTERIES ACCORDING TO THE MANUFACTURER'S INSTRUCTIONS.**
17. The sound pressure level at the operator's position according to IEC 704-1:1982 is no more than 70 dB (A).

DISCLAIMER: This set of instructions is given according to IEC 704-1. Advantech disclaims all responsibility for the accuracy of any statements contained herein.

Contents

Chapter 1	General Information	1
1.1	Introduction	2
1.2	Functional Block Diagram	4
1.3	Product Specifications.....	5
1.3.1	Compliance.....	5
1.3.2	Feature List.....	5
1.3.3	Processor System.....	6
1.3.4	Graphics/Audio	6
1.3.5	Expansion Interface	7
1.3.6	LPC.....	7
1.3.7	Serial Bus.....	7
1.3.8	I/O	7
1.3.9	Power Management.....	9
1.3.10	Environment.....	10
1.3.11	MTBF	10
1.3.12	OS Support (SW Chapter Duplicate)	10
1.3.13	Advantech iManager	10
1.3.14	Power Consumption.....	11
1.3.15	Performance	11
1.3.16	Selection Guide w/P/N.....	12
1.3.17	Packing list.....	12
1.3.18	Development Board	12
1.3.19	Optional Accessories	12
1.3.20	Pin Description.....	13
Chapter 2	Mechanical Information	15
2.1	Board Information.....	16
	Figure 2.1 Board Chips Diagram – Front.....	16
	Figure 2.2 Board Chips Diagram – Rear	16
2.1.1	Connector List.....	17
	Table 2.1: FAN1 Fan	17
2.2	Mechanical Diagram	17
	Figure 2.3 Board Mechanical Drawing – Front	17
	Figure 2.4 Board Mechanical Diagram – Rear	18
	Figure 2.5 Board Mechanical Diagram – Side	18
2.3	Exploded Diagram.....	19
	Figure 2.6 Assembly Diagram	19
2.4	Assembly Diagram	20
	Figure 2.7 10 TGL-UP3 4C Height and Tolerance Diagram	20
Chapter 3	AMI BIOS	21
3.1	Introduction	22
	Figure 3.1 Setup Program Initial Screen.....	22
3.2	Entering Setup	23
3.3	Main Setup.....	23
	Figure 3.2 Main Setup Screen	23
3.4	Advanced BIOS Features Setup	24
	Figure 3.3 Advanced BIOS Features Setup Screen	24
3.4.1	RC ACPI Settings	25
	Figure 3.4 RC ACPI Settings	25
3.4.2	CPU Configuration	26

	Figure 3.5 CPU Configuration_1	26
	Figure 3.6 Active Processor Core Setting	27
3.4.3	Power & Performance.....	28
	Figure 3.7 Power & Performance	28
	Figure 3.8 CPU- Power Management Control.....	29
	Figure 3.9 Configurable TDP Boot Mode	30
	Figure 3.10 ConfigTDP Turbo Activation Ratio	30
	Figure 3.11 GT- Power Management Control	31
3.4.4	PCH-FW Configuration.....	32
	Figure 3.12PCH-FW Configuration.....	32
	Figure 3.13 Firmware Update Configuration	33
3.4.5	Trusted Computing	33
	Figure 3.14 Trusted Computing.....	33
3.4.6	ACPI Settings	34
	Figure 3.15 ACPI Settings.....	34
3.4.7	Embedded Controller.....	35
	Figure 3.16 Embedded Controller	35
	Figure 3.17 Serial Port 1 Configurations	36
	Figure 3.18 Serial Port 2 Configurations	37
	Figure 3.19 Hardware Monitor.....	38
3.4.8	Serial Port Console Redirection.....	38
	Figure 3.20 Serial Port Console Redirection	38
	Figure 3.21 Terminal Type Settings	39
	Figure 3.22 Terminal Type Settings	39
	Figure 3.23 Data Bits Settings.....	40
	Figure 3.24 Parity Settings	40
	Figure 3.25 Stop Bits Settings	41
	Figure 3.26 Flow Control Settings	41
	Figure 3.27 Putty KeyPad Settings.....	42
3.4.9	USB Configuration	43
	Figure 3.28 USB Configuration.....	43
	Figure 3.29 USB Transfer Time-out Settings	44
	Figure 3.30 Device Power-up Delay Settings.....	44
3.4.10	NVMe Configuration	45
	Figure 3.31 NVMe Configuration	45
3.4.11	Network Stack Configuration	46
	Figure 3.32 Network Stack Configuration.....	46
	Figure 3.33 Network Stack Configuration Settings.....	46
3.5	Chipset Settings.....	47
	Figure 3.34 Chipset Setup.....	47
3.5.1	System Agent (SA) Configuration.....	48
	Figure 3.35 System Agent (SA) Configuration	48
	Figure 3.36 Memory Configuration.....	49
	Figure 3.37 Graphics Configuration.....	49
	Figure 3.38 Primary Display	50
	Figure 3.39 Internal Graphics Settings.....	50
	Figure 3.40 GTT Size Settings	51
	Figure 3.41 Aperture Size Settings.....	51
	Figure 3.42 DVMT Pre-Allocated Settings.....	52
	Figure 3.43 DVMT Toal Gfx Mem Settings.....	52
	Figure 3.44 PM Support Settings	53
	Figure 3.45 LCD Control Setting	54
	Figure 3.46 Color Depth and Packing Format Settings.....	54
	Figure 3.47 Dual LVDS Mode Settings.....	55
	Figure 3.48 LCD Panel Type	55
	Figure 3.49 LVDS Clock Spreading Settings.....	56
	Figure 3.50 LVDS Swing Level Settings.....	56
3.5.2	PCH-IO Configuration.....	57
	Figure 3.51 PCH-IO Configuration	57
	Figure 3.52 PCI Express Configuration	58

	Figure 3.53 PCI Express Root Port 0 Configuration	59
	Figure 3.54 SATA And RST Configuration	60
	Figure 3.55 USB Configuration	61
	Figure 3.56 Security Configuration Settings	62
	Figure 3.57 HD Audio Configuration	63
	Figure 3.58 Security Configuration Settings	64
	Figure 3.59 Serial I/O Configuration Settings	65
3.5.3	Security Settings	66
	Figure 3.60 Security Setup	66
3.5.4	Boot Settings.....	67
	Figure 3.61 Security Setup	67
3.5.5	Save & Exit	68
	Figure 3.62 Security Setup	68

Chapter 4 S/W Introduction and Installation69

4.1	S/W Introduction.....	70
4.2	Driver Installation	70
	4.2.1 Windows Driver Setup	70
	4.2.2 Other OS.....	70
4.3	Advantech iManager	71

Appendix A Pin Assignment73

A.1	SOM-6883 Type 6 Pin Assignment.....	74
-----	-------------------------------------	----

Appendix B Watchdog Timer79

B.1	Programming the Watchdog Timer	80
-----	--------------------------------------	----

Appendix C Programming GPIO81

C.1	GPIO Register.....	82
-----	--------------------	----

Appendix D System Assignments83

D.1	System I/O Ports	84
	Table D.1: System I/O ports	84
D.2	Interrupt Assignments	85
	Table D.2: Interrupt Assignments.....	85
D.3	1st MB Memory Map	85
	Table D.3: 1st MB Memory Map	85

Chapter 1

General Information

This chapter details the SOM-6883 CPU Computer on Module background information.

Sections include:

- Introduction
- Functional Block Diagram
- Product Specifications

1.1 Introduction

Advantech's SOM-6883 series feature 11th Gen Intel® Core™/Celeron processors that leverage 14nm process technology. These solutions support DDR4 3200MT/s with 1.2V power design, up to 16GB memory down, and 32GB SO-DIMM. In addition, SOM-6883 augments memory capacity configuration via an i7-1185G7E SKU upgrade to quad-core. SOM-6883 further provides super speed I/O technology — such as 2.5Gbase-T TSN LAN, PCIe Gen 4, and USB 3.2 Gen 2.

This solution also integrates 11th Gen. Intel® Core™ processors Iris® Xe Graphics to empower up to four independent 4K displays or two 8K HDR ports.

This device features Advantech's iManager (SUSI4). This software meets embedded application requirements by providing a multi-level watchdog timer, voltage and temperature monitoring, thermal protection, and mitigation via processor throttling, LCD backlight on/off and brightness control, and embedded storage for customized information. When combined with Advantech WISE-DeviceOn, it can remotely monitor and control devices.

Acronyms	
Term	Define
AC'97	Audio CODEC (Coder-Decoder)
ACPI	Advanced Configuration Power Interface – standard for implementing power saving modes in PC-AT systems
BIOS	Basic Input Output System – firmware in PC-AT system that is used to initialize system components before handing control over to the operating system
CAN	Controller-area network (CAN or CAN-bus) is a vehicle bus standard designed to allow micro-controllers to communicate with each other within a vehicle without a host computer
DDI	Digital Display Interface – Contains DisplayPort, HDMI/DVI, and SDVO
EAPI	Embedded Application Programmable Interface Software interface for COM Express [®] specific industrial function <ul style="list-style-type: none"> ■ System information ■ Watchdog timer ■ I2C Bus ■ Flat Panel brightness control ■ User storage area ■ GPIO
GbE	Gigabit Ethernet
GPIO	General purpose input output
HDA	Intel High Definition Audio (HD Audio) refers to the specification released by Intel [®] in 2004 for delivering high definition audio that is capable of playing back more channels at higher quality than AC'97
I2C	Inter-Integrated Circuit – 2 wire (clock and data) signaling scheme allowing communication between integrated circuit, primarily used to read and load register values
ME	Management Engine
PC-AT	“Personal Computer – Advanced Technology” – an IBM trademark term used to refer to Intel based personal computer in 1990s
PEG	PCI Express Graphics
RTC	Real Time Clock – battery backed circuit in PC-AT systems that keeps system time and date as well as certain system setup parameters
SPD	Serial Presence Detect – refers to serial EEPROM on DRAMs that has DRAM Module configuration information
TPM	Trusted Platform Module, chip to enhance the security features of a computer system
UEFI	Unified Extensible Firmware Interface
WDT	Watchdog Timer

1.2 Functional Block Diagram

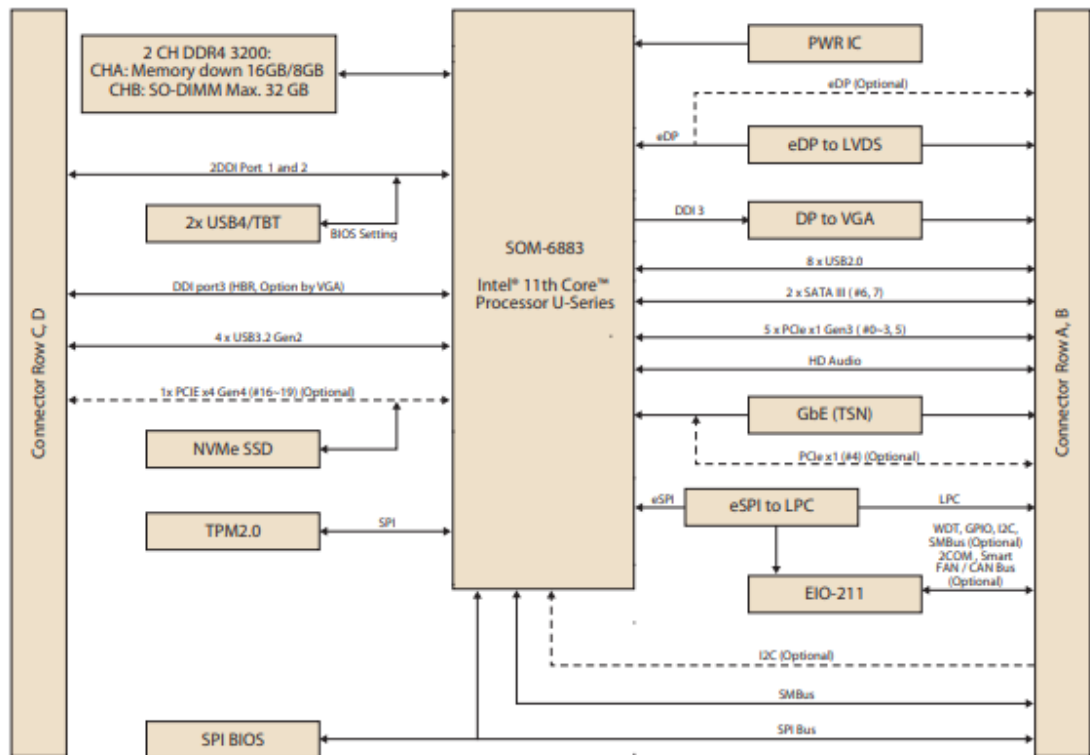

1.3 Product Specifications

1.3.1 Compliance

- PICMG COM.0 (COM Express) Revision 3.0
- Compact Size – 95 x 95 mm (3.7 x 3.7 in)
- Pin-out type 6 compatible

1.3.2 Feature List

Feature Type	Connector Row	Feature	Type 6 Define		SOM-6883
			Max.	Min.	
Display	A-B	LVDS Channel A (18/24-bit)	1	0	1
	A-B	LVDS Channel B (18/24-bit)	1	0	1
	A-B	eDP (muxed on LVDS Channel A)	1	0	1
	A-B	VGA	1	0	1
Expansion	A-B	PCI Express x1	6	1	6
	A-B	LPC	1	1	1
Serial	A-B	SMBus	1	1	1
	A-B	I2C Bus	1	1	1
	A-B	Serial Port	2	0	2
	A-B	CAN Bus (mixed on SER1)	1	0	1
I/O	A-B	LAN Port 0 (Gigabit Ethernet)	1	1	1
	A-B	SATA	4	1	2
	A-B	USB 2.0	8	4	8
	A-B	USB Client	1	0	0
	A-B	HD Audio	1	0	1
	A-B	SPI Bus	2	1	1
	A-B	General Purpose I/O (GPIO)	8	8	8
	A-B	SDIO (muxed on GPIO)	1	0	0
	A-B	Express Card Support	2	1	2
	A-B	Watchdog Timer Output	1	0	1
	A-B	Speaker Out	1	1	1
	A-B	External BIOS ROM Support	2	0	2
	A-B	Power Button Support	1	1	1
	A-B	Power Good	1	1	1
	A-B	VCC_5V_SBY Contacts	4	4	4
	A-B	Sleep	1	0	1
	A-B	Thermal Protection	1	0	1
	A-B	Lid Input	1	0	1
	A-B	Battery Low Alarm	1	0	1
	A-B	Suspend/Wake Signals	3	0	3
A-B	Fan PWM / Tachometer	2	0	2	
A-B	Trusted Platform Modules	1	0	1	
Display	C-D	Digital Display Interfaces 1 - 3	3	0	3

Feature Type	Connector Row	Feature	Type 6 Define		SOM-6883
			Max.	Min.	
I/O	C-D	PEG (PCI Express x16)	1	0	0
	C-D	PCI Express x1	2	0	2
	C-D	USB 3.0 (Gen2, 10Gbps)	4	0	4
	C-D	Rapid Shutdown	1	0	1

1.3.3 Processor System

CPU	Std. Freq.	Max. Turbo Freq.	Core	Cache (MB)	TDP(W)
i7-1185G7E	1.8GHz	4.4GHz	4	12	15*
i5-1145G7E	1.5GHz	4.1GHz	4	8	15*
i3-1115G4E	2.2GHz	3.9GHz	2	6	15*
Celeron® 6305E	1.8GHz	N/A	2	4	15
i7-1185GRE	1.8GHz	4.4GHz	4	12	15*
i5-1145GRE	1.5GHz	4.1GHz	4	8	15*
i3-1115GRE	2.2GHz	3.9GHz	2	6	15*

*TDP can be configured up to 28W or down to 12W.

1.3.4 Graphics/Audio

Iris® Xe Graphics uses high-performance, low-power HW acceleration for video decoding operations to accommodate multiple video codecs.

The HW encode is exposed via the graphics driver using the following APIs:

- Intel Media SDK
- MFT (Media Foundation Transform) filters

Iris® Xe Graphics supports full HW accelerated video encoding for AVC/MPEG2/HEVC/VP8/JPEG.

CPU	Graphic Core	Base Freq.	Max Freq.
i7-1185G7E	Iris® Xe Graphics	1.8GHz	4.4GHz
i5-1145G7E	Iris® Xe Graphics	1.5GHz	4.1GHz
i3-1115G4E	Iris® Xe Graphics	2.2GHz	3.9GHz
Celeron® 6305E	Intel® UHD Graphics	1.8GHz	N/A
i7-1185GRE	Iris® Xe Graphics	1.8GHz	4.4GHz
i5-1145GRE	Iris® Xe Graphics	1.5GHz	4.1GHz
i3-1115GRE	Intel® UHD Graphics	2.2GHz	3.9GHz

1.3.5 Expansion Interface

PCIe x1

PCI Express x1: Supports 5 x ports PCIe x1 and is compliant with PCIe Gen3 (8.0 GT/s) specifications. It is configurable to PCIe x4 or PCIe x2. Several configurable combinations may need BIOS modifications. Please contact Advantech sales or FAE for further details.

Type 6		Row A,B					Row C,D		
		P0	P1	P2	P3	P4	P5	P6	P7
Default	Config.	X1	X1	X1	X1	2.5G LAN	X1	SATA#0	SATA#1
Option 1		X1	X1	X2		X1	X1	X2	
Option 2		X2		X2		X2		X2	
Option 3		X4				X4			

1.3.6 LPC

Supports Low Pin Count (LPC) 1.1 specifications without DMA or bus mastering. Supports connection to Super I/O, embedded controller, or TPM. The LPC clock is 24MHz.

1.3.7 Serial Bus

1.3.7.1 SMBus

Supports SMBus 2.0 specifications with alert pin.

1.3.7.2 I2C Bus

Supports I2C bus 7/10-bit address modes at both 100 and 400KHz.

1.3.8 I/O

1.3.8.1 Gigabit Ethernet

Ethernet: Intel I225IT Gigabit LAN supports 10/100/1000/2.5G Mbps Speed.

1.3.8.2 SATA

Supports up to 2 x ports SATA Gen 3 (6.0 Gb/s), backward compliant to SATA Gen 2 (3.0 Gb/s) and Gen 1 (1.5 Gb/s). The maximum data rate is 600 MB/s. It supports AHCI 1.3 and 1.3.1 mode.

1.3.8.3 USB 3.0 (3.1 Gen 2) and USB 2.0

SOM-6883 supports 4 x USB 3.2 Gen 2 (10 Gbps) ports and 8 x USB 2.0 (480 Mbps) ports. These are backwards compatible with USB 1.x. USB 3.1 supports LPM (U0, U1, U2, and U3) manageability to conserve power.

Notice: Use a certified cable to maximize USB 3.2 Gen 2 performance.

1.3.8.4 USB 3.1

Type 6	P0	P1	P2	P3
SoC	P0	P1	P2	P3
Type 6	USB_OC#01		USB_OC#23	
SoC USB_OC#	USB_OC#01		USB_OC#23	

1.3.8.5 USB 2.0

Type 6	P0	P1	P2	P3	P4	P5	P6	P7
SoC	P0	P1	P2	P3	P4	P5	P6	P7
Type 6	USB_OC#01		USB_OC#23		USB_OC#45		USB_OC#67	
SoC USB_OC#	USB_OC#01		USB_OC#23		USB_OC#45		USB_OC#67	

1.3.8.6 SPI Bus

Supports BIOS flash only. The SPI clock can be 17, 30, or 48MHz; with a capacity up to 16MB.

1.3.8.7 GPIO

8 x programmable general purpose input or output (GPIO).

1.3.8.8 Watchdog

Supports multi-level watchdog time-out output. Provides 1-65535 level, from 100 milliseconds to 109.22 minutes interval.

1.3.8.9 Serial Port

2 x 16550 UART compliant 2-wire serial port (Tx/Rx):

- Programmable FIFO or character mode
- 16-byte FIFO buffer on transmitter and receiver in FIFO mode
- Programmable serial-interface characteristics: 5, 6, 7, or 8-bit character
- Even, odd, or no parity bit selectable
- 1, 1.5, or 2 stop bit selectable
- Baud rate up to 115.2K

1.3.8.10 TPM

Supports TPM 2.0 module by default.

1.3.8.11 Smart Fan

Supports 2 x fan PWM control signals and 2 x tachometer inputs for fan speed detection. Provides 1 x on module with connector and 1 x on carrier board to meet PICMG COM Express R3.0 specifications.

1.3.8.12 BIOS

There is a BIOS chip on the module by default. Users can place the BIOS chip on a carrier boards with appropriate designs and jumper settings on BIOS_DIS#[1:0].

BIOS_DIS0#	BIOS_DIS#1	Boot up destination/function
Open	Open	Boot from Module's SPI BIOS
Open	GND	SPI_CS0# to Carrier Board, SPI_CS1# to Module
GND	GND	SPI_CS0# to Module, SPI_CS1# to Carrier Board

Notice: We recommend going to the BIOS setup menu and loading the default settings during the first boot up if the system COMS are cleared.

1.3.8.13 Clear CMOS

Setting Type	Jumper Setting	Clear RTC CMOS (Time and Date)	BIOS Setting Load Default
Default Settings	Without jumper	V	N/A
Optional Settings	Jumper 1-2	V	V

*Contact local AE for support

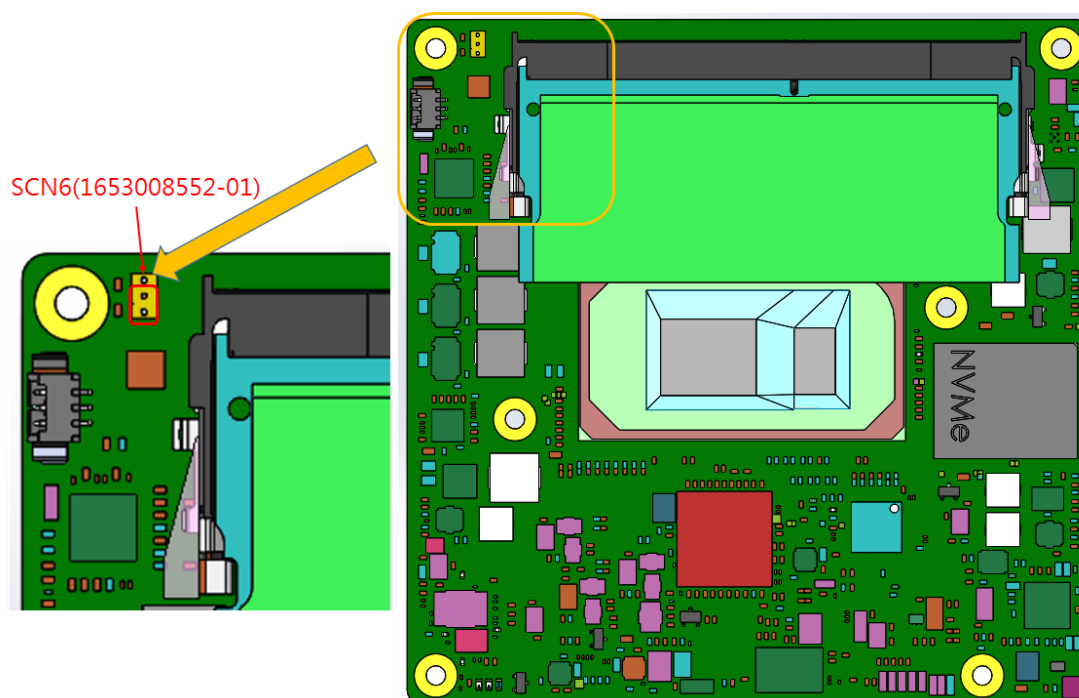

1.3.9 Power Management

1.3.9.1 Power Supply

Supports both ATX and AT power modes. The VSB function is for suspend power and is optional if not required by standby (suspend-to-RAM) support. The RTC Battery is optional if keeping the time and date is not required.

- VCC: 8.5 ~ 20V
- VSB: 4.75 ~ 5.25V (Suspend power)
- RTC Battery Power: 2.0 ~ 3.3V

1.3.9.2 PWROK

Power OK (PWROK) measures the main power supply. A high value indicates sufficient power. This signal can be used to delay module startup in order to program the time of carrier based FPGAs or other configurable devices.

1.3.9.3 Power Sequence

Adheres to PICMG COM Express R3.0 specifications.

1.3.9.4 Wake Event

Diverse wake-up event support allows users to apply the solution to different scenarios:

- Wake-on-LAN (WOL): Wake to S0 from S3/S4/S5

- USB Wake: Wake to S0 from S3/S4
- PCIe Device Wake: According to user inquiry and BIOS customization
- LPC Wake: According to user inquiry and BIOS customization

1.3.9.5 Advantech S5 ECO Mode (Deep Sleep Mode)

Advantech iManager features a mechanism that allows the system to enter a very low suspended power mode, or “S5 ECO mode”. In this mode, the module will cut power entering the chipset — including suspend and active power — and keep an on-module controller active. In this mode, the device will only consume 50mW to enable a longer battery pack lifespan. This mode is enabled using BIOS. In this mode the system (or module) needs to use the power button to boot up.

1.3.10 Environment

1.3.10.1 Temperature

- Operating: 0 ~ 60 °C (32 ~ 140 °F), with an active heat sink under 0.7m/s air flow chamber
- Storage: -40 ~ 85 °C (-40 ~ 185 °F)

1.3.10.2 Humidity

- Operating: 40 °C @ 95% relative humidity, non-condensing
- Storage: 60 °C @ 95% relative humidity, non-condensing

1.3.10.3 Vibrations

- IEC60068-2-64: Random vibration test during operation at 3.5 Grms

1.3.10.4 Drop Test (Shock)

- Federal Standard 101 method 5007 test procedure with standard packing

1.3.10.5 EMC

- CE EN55022 Class B and FCC Certifications: validated using standard development boards on an Advantech chassis

1.3.11 MTBF

- Please refer to the Advantech SOM-6883 Series Reliability Prediction Report No: TBD. (Estimated date: TBD)

1.3.12 OS Support (SW Chapter Duplicate)

Connect to Internet and visit this website: <http://support.advantech.com.tw> to download a setup file and install drivers.

1.3.13 Advantech iManager

iManager supports APIs for GPIO, smart-fan control, multi-stage watchdog timer, and output, temperature sensor, hardware monitor, etc. Follow by PICMG EAPI 1.0 specification to enable backwards compatibility.

1.3.14 Power Consumption

Power Consumption Table (Watt.)						
VCC=12V, VSB=5V	Active Power Domain			Suspend Power Domain		Mechanical off
Power State	S0 Max. Load	S0 Burn-in	S0 Idle	S5	S5 Deep Sleep	RTC (uA)
SOM-6883C7A-S8A1	54.099W	39.654W	7.834W	1.494W	0.23W	6.19uA

Hardware Configurations:

1. MB: SOM-6883C7A-S8A1 (PCB: A101-2)
2. DRAM: Total 48GB (Micron 32GB DDR4 3200 SO 1 x pcs)
3. Carrier board: SOM-DB5830 A201-2

Test Condition:

1. Test temperature: 25 °C/77 °F
2. Test voltage: rated voltage DC +12.0V
3. Test loading:
 - Maximum load mode: Running programs
 - Idle mode: DUT power management off and not running any program
4. OS: Windows 10 Enterprise

1.3.15 Performance

Please refer to the “Advantech COM Performance and Power Consumption Table” for reference performance and/or benchmark data.

1.3.16 Selection Guide w/P/N

P/N	CPU	Cores	CPU TDP	Onboard Memory	Onboard NVMe	PCIe x4 GEN4	eDP/ LVDS	ECC Memory Supported	IBECC Supported	Power	Thermal Solution	Operating Temperature
SOM-6883C7A-S8A1	Core™ i7-1185G7E	4	15W	16GB	32GB	N/A	LVDS	N/A	N/A	AT/ATX	Active	0 ~ 60 °C (32 ~ 140 °F)
SOM-6883C7-S8A1	Core™ i7-1185G7E	4	15W	16GB	N/A	Yes	LVDS	N/A	N/A	AT/ATX	Active	0 ~ 60 °C(32 ~ 140 °F)
SOM-6883C5-S5A1	Core™ i5-1145G7E	4	15W	8GB	N/A	Yes	LVDS	N/A	N/A	AT/ATX	Active	0 ~ 60 °C(32 ~ 140 °F)
SOM-6883C3-U2A1	Core™ i3-1115G4E	2	15W	N/A	N/A	Yes	LVDS	N/A	N/A	AT/ATX	Active	0 ~ 60 °C(32 ~ 140 °F)
SOM-6883C3A-U2A1	Core™ i3-1115G4E	2	15W	N/A	N/A	Yes	eDP	N/A	N/A	AT/ATX	Active	0 ~ 60 °C(32 ~ 140 °F)
SOM-6883CR-S8A1	Celeron® 6305E	2	15W	N/A	N/A	Yes	LVDS	N/A	N/A	AT/ATX	Active	0 ~ 60 °C(32 ~ 140 °F)
SOM-6883R7X-S8A1	Core™ i7-1185GRE	4	15W	16GB	32GB	N/A	LVDS	Yes	Yes	AT/ATX	Active	-40 ~ 85 °C (-40 ~ 185 °F)
SOM-6883R5X-S5A1	Core™ i5-1145GRE	4	15W	8GB	N/A	Yes	LVDS	Yes	Yes	AT/ATX	Active	-40 ~ 85 °C (-40 ~ 185 °F)
SOM-6883R3X-U2A1	Core™ i3-1115GRE	2	15W	NA	N/A	Yes	LVDS	Yes	Yes	AT/ATX	Active	-40 ~ 85 °C(-40 ~ 185 °F)
SOM-6883C3B-U2A1 (for MZ10)	Core™ i3-1115G4E	4	15W	16GB	32GB	N/A	LVDS	Yes	N/A	AT/ATX	Active	0 ~ 60 °C(32 ~ 140 °F)

1.3.17 Packing list

Part No.	Description	Quantity
1970004766T001	SOM-6883 Heatspreader	1pcs

1.3.18 Development Board

Part No.	Description
SOM-DB5830-00A2	COMe Devel.Board COMe R3.0 Type6 pin-out

1.3.19 Optional Accessories

Part No.	Description
1970004870T001	Semi-Cooler 95 x 95 x 33 mm/3.7 x 3.7 x 1.29 in with 12V Fan
1970004871T001	QFCS 95 x 95 x 26 mm/3.7 x 3.7 x 1.02 in

1.3.20 Pin Description

Advantech provides checklists for schematic design and layout routing. The schematic checklist details pin electrical properties and connections for different scenarios. The checklist also specifies layout constraints and recommendations for trace length and impedance.

Please contact Advantech for further support.

Chapter 2

Mechanical Information

This chapter details SOM-6883 CPU Computer on Module mechanical information

Sections include:

- Board Information
- Mechanical Drawing
- Assembly Drawing

2.1 Board Information

The figures below show the main chips on the SOM-6883 Computer-on-Module. To avoid mechanical damage and improve heat dissipation performance — please keep these positions in mind when designing carrier boards.

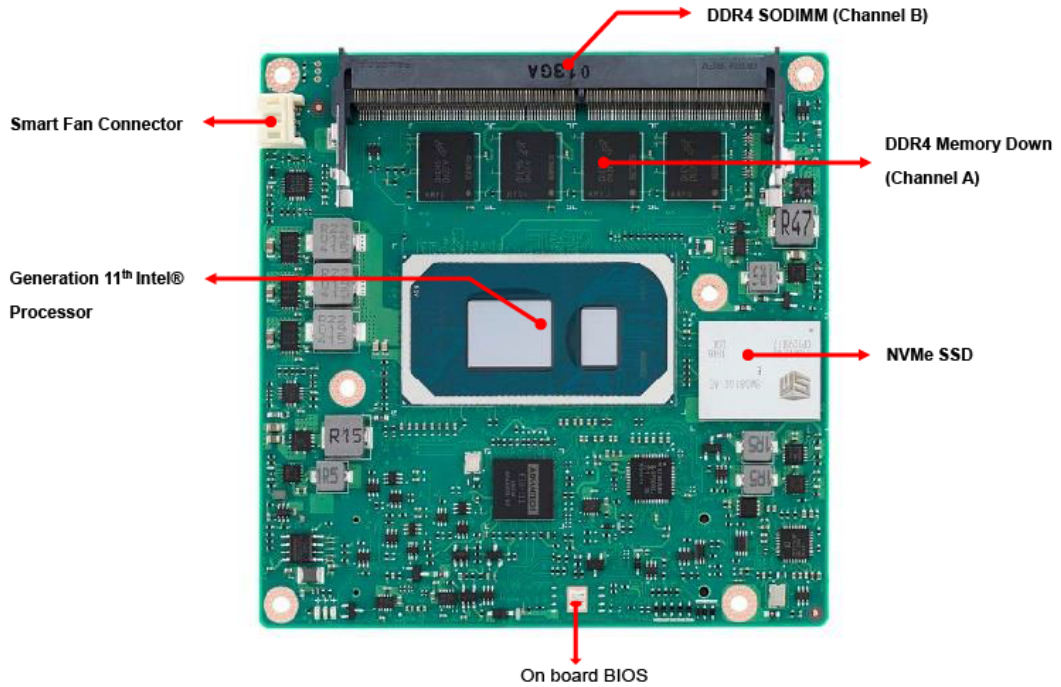

Figure 2.1 Board Chips Diagram – Front

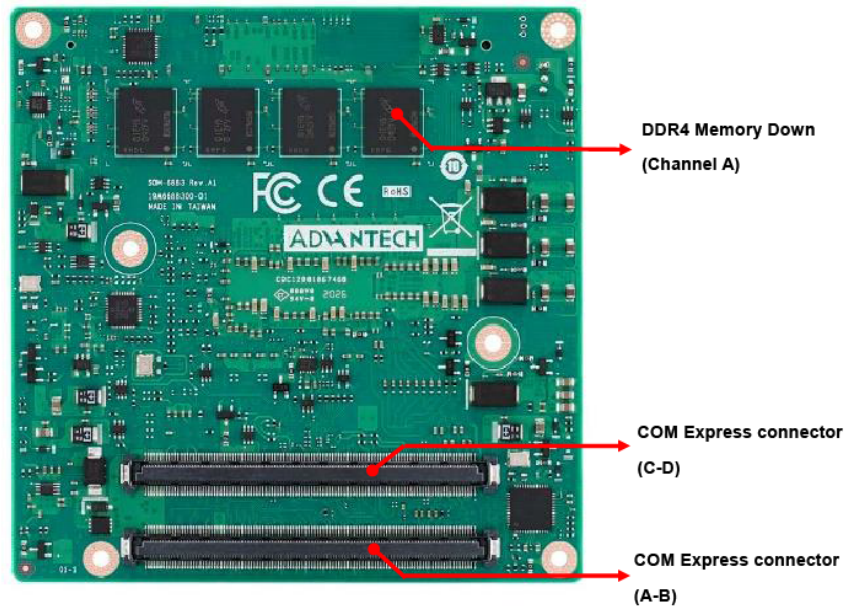
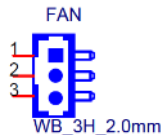

Figure 2.2 Board Chips Diagram – Rear

2.1.1 Connector List

Table 2.1: FAN1 Fan

FAN1	Fan
Description	Wafer 1.25 mm 3P 90D(M)DIP 53261-0371
Pin	Pin Name
1	Fan Tacho-Input
2	Fan Out
3	GND



2.2 Mechanical Diagram

For further details or information regarding 2D/3D models, please visit the Advantech COM support service website <http://com.advantech.com>.

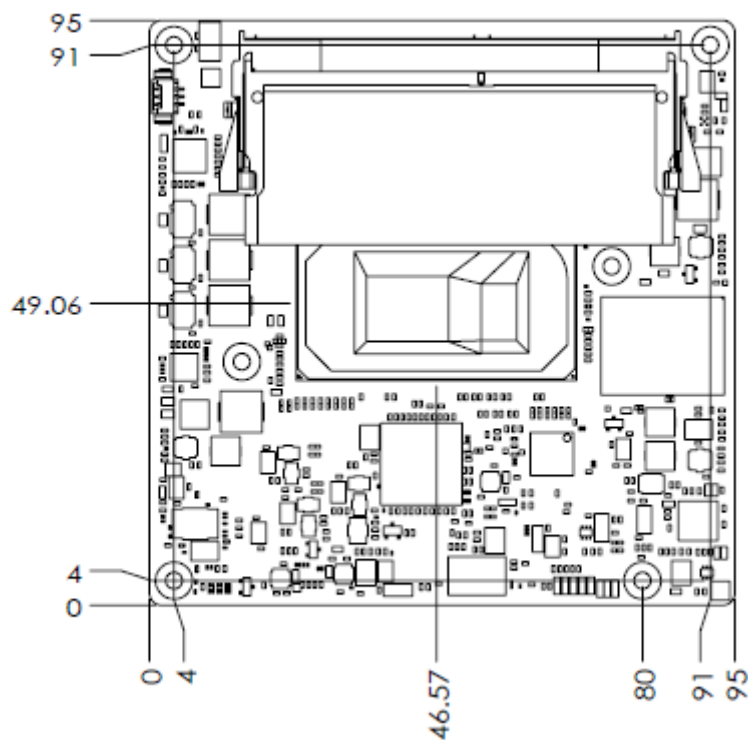

Figure 2.3 Board Mechanical Drawing – Front

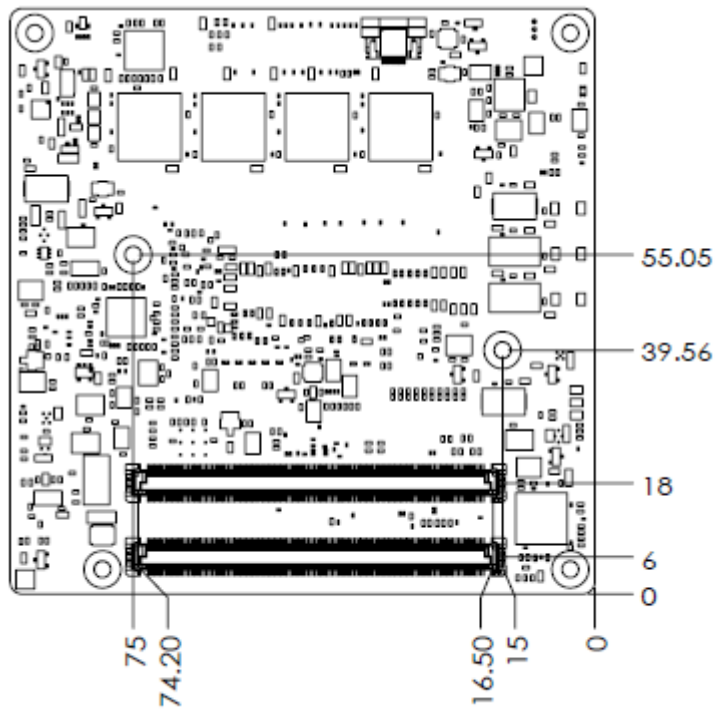

Figure 2.4 Board Mechanical Diagram – Rear

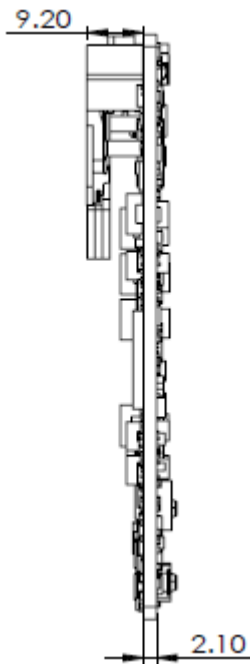

Figure 2.5 Board Mechanical Diagram – Side

2.3 Exploded Diagram

These figures demonstrate the thermal module assembly order — from COM module to carrier board.

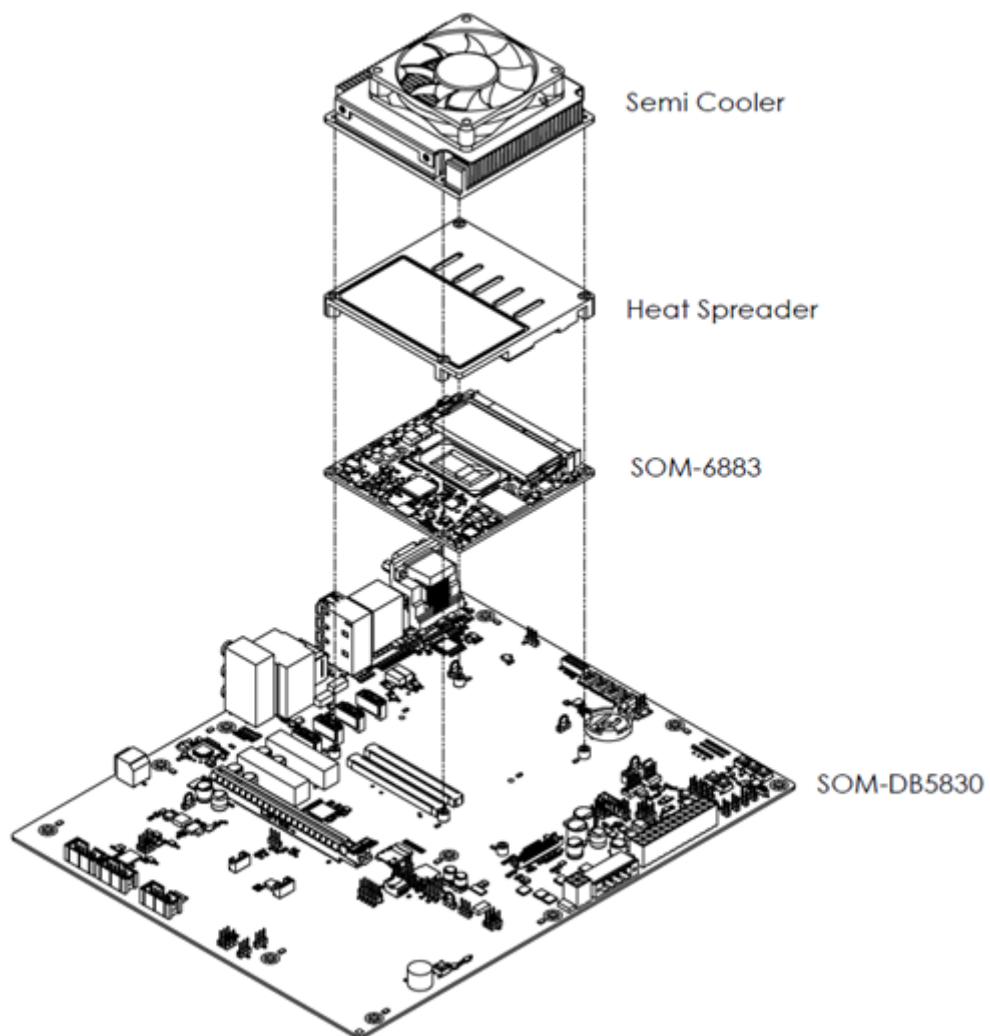

Figure 2.6 Assembly Diagram

There are 4 x reserved screw holes on SOM-6883 used in heat spreader assembly.

2.4 Assembly Diagram

Please consider the CPU and chip height tolerance when designing your thermal solution.

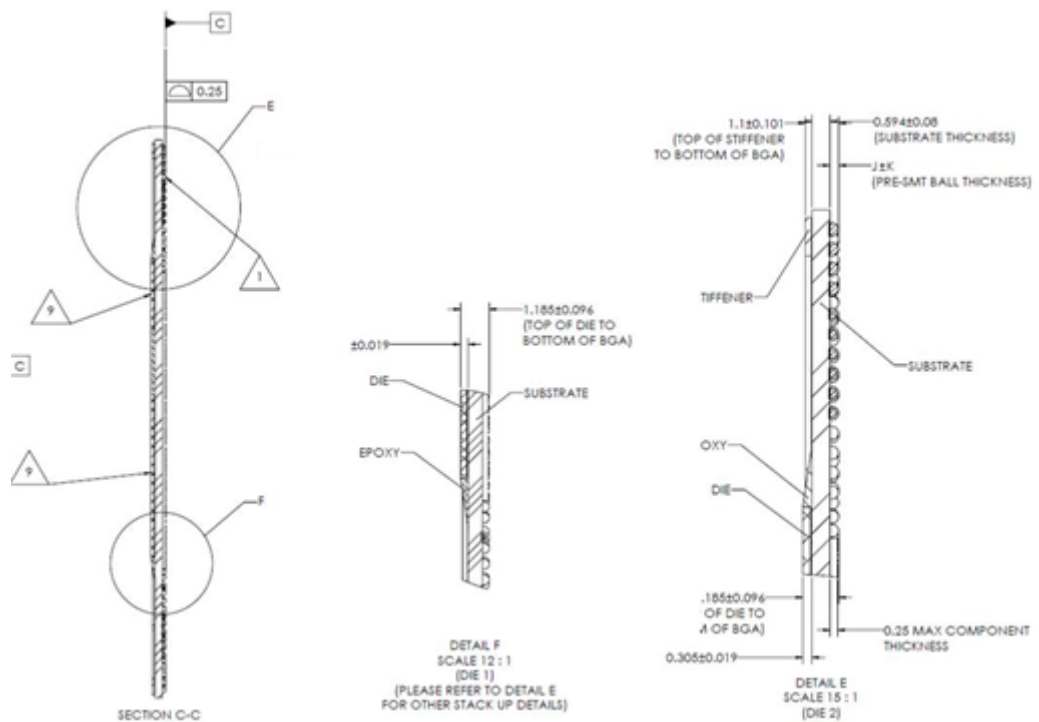

Figure 2.7 10 TGL-UP3 4C Height and Tolerance Diagram

(For all other SKUs please contact to Advantech sales or FAE for further details.)

Chapter 3

AMI BIOS

This chapter details SOM-6883 BIOS setup information.

Sections include:

- Introduction
- Entering Setup
- Hot/operation Key
- Exit BIOS Setup Utility

3.1 Introduction

AMI BIOS has been integrated into many motherboards for over a decade. With the AMI BIOS Setup Utility, users can modify BIOS settings and control various system features. This chapter describes the basic navigation of the BIOS Setup Utility.

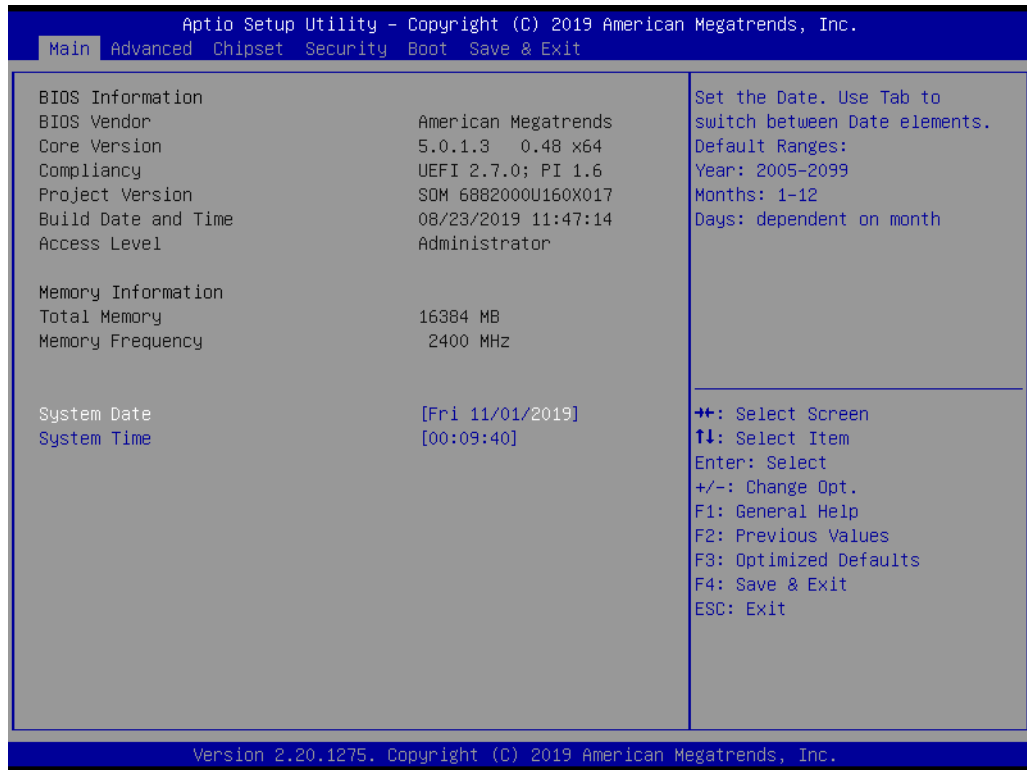

Figure 3.1 Setup Program Initial Screen

AMI's BIOS ROM has a built-in Setup program that allows users to modify the basic system configuration. This information is stored in flash ROM so it retains the Setup information when the power is turned off.

3.2 Entering Setup

Turn on the computer and then press or <ESC> to enter the Setup menu.

3.3 Main Setup

When users first enter the BIOS Setup Utility they enter the Main setup screen. Users can always return to the Main setup screen by selecting the Main tab. There are two Main Setup options. They are described in this section. The Main BIOS Setup screen is shown below.



Figure 3.2 Main Setup Screen

The Main BIOS setup screen has two main frames. The left frame displays all the options that can be configured. Grayed-out options cannot be configured; options in blue can. The right frame displays the key legend.

Above the key legend is an area reserved for a text message. When an option is selected in the left frame, it is highlighted in white. Often a text message will accompany it.

■ System time/System date

Use this option to change the system time and date. Highlight System Time or System Date using the <Arrow> keys. Enter new values through the keyboard. Press the <Tab> key or the <Arrow> keys to move between fields. The date must be entered in MM/DD/YY format. The time must be entered in HH:MM:SS format.

3.4 Advanced BIOS Features Setup

Select the Advanced tab from the SOM-6883 setup screen to enter the Advanced BIOS Setup screen. Users can select any item in the left frame of the screen, such as CPU Configuration, to go to the sub menu for that item. Users can display an Advanced BIOS Setup option by highlighting it using the <Arrow> keys. All Advanced BIOS Setup options are described in this section. The Advanced BIOS Setup screens are shown below. The sub menus are described on the following pages.

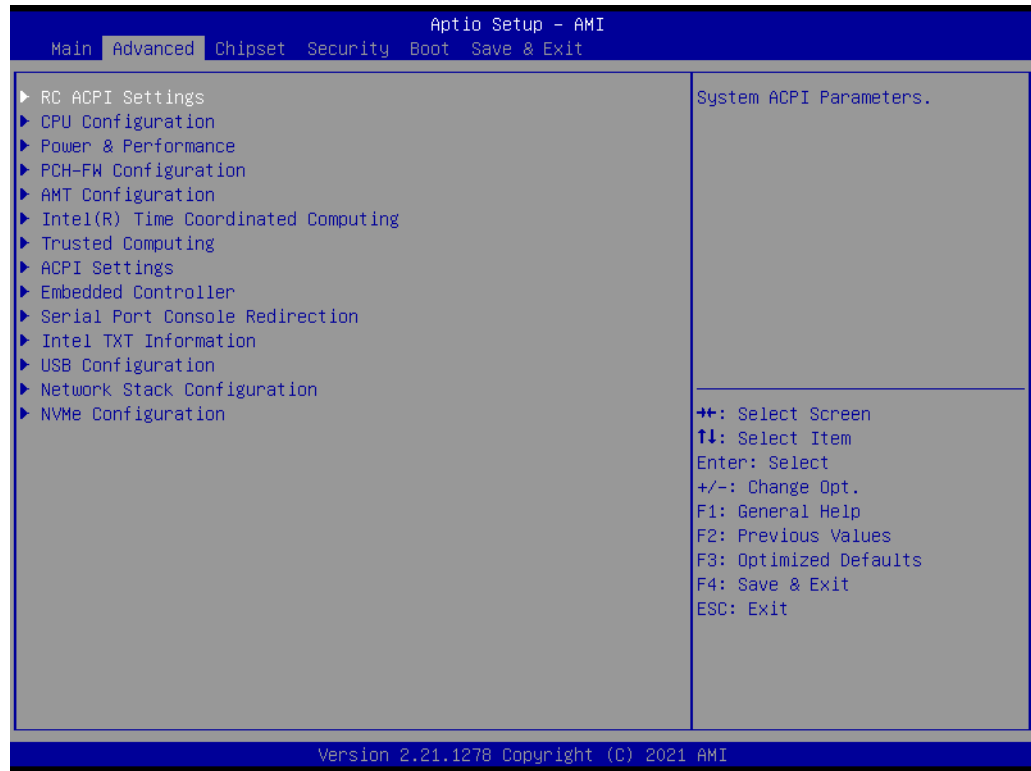

Figure 3.3 Advanced BIOS Features Setup Screen

3.4.1 RC ACPI Settings



Figure 3.4 RC ACPI Settings

3.4.2 CPU Configuration

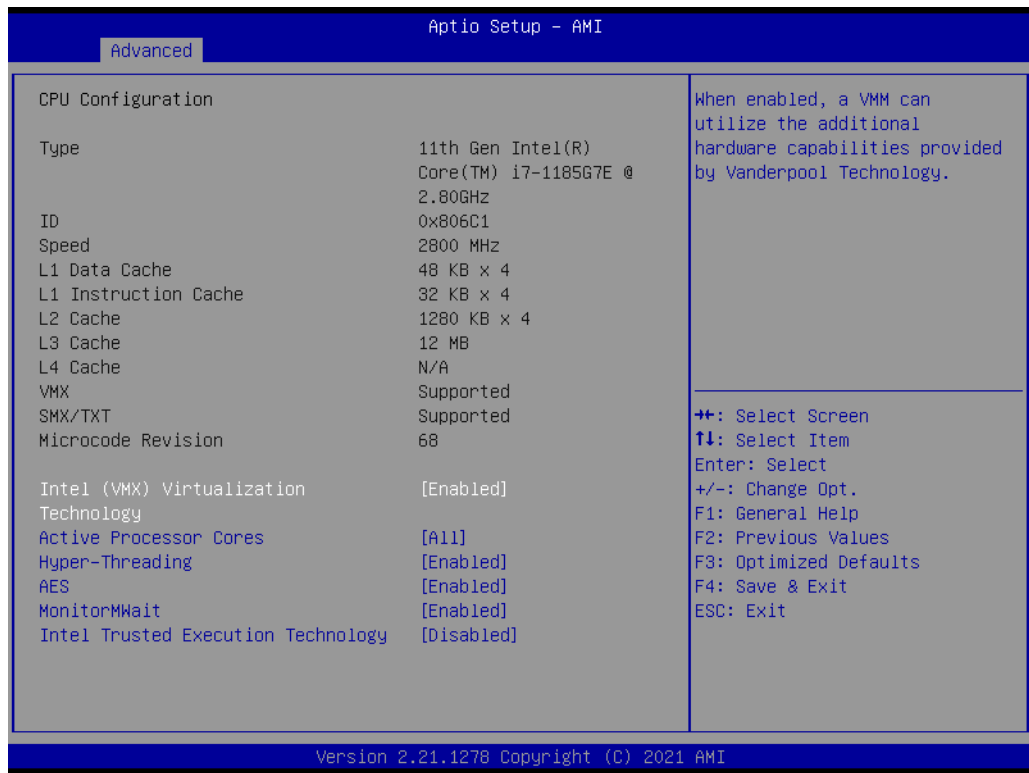

Figure 3.5 CPU Configuration_1

- Intel (VMX) Virtualization Technology
- Active Processor Core

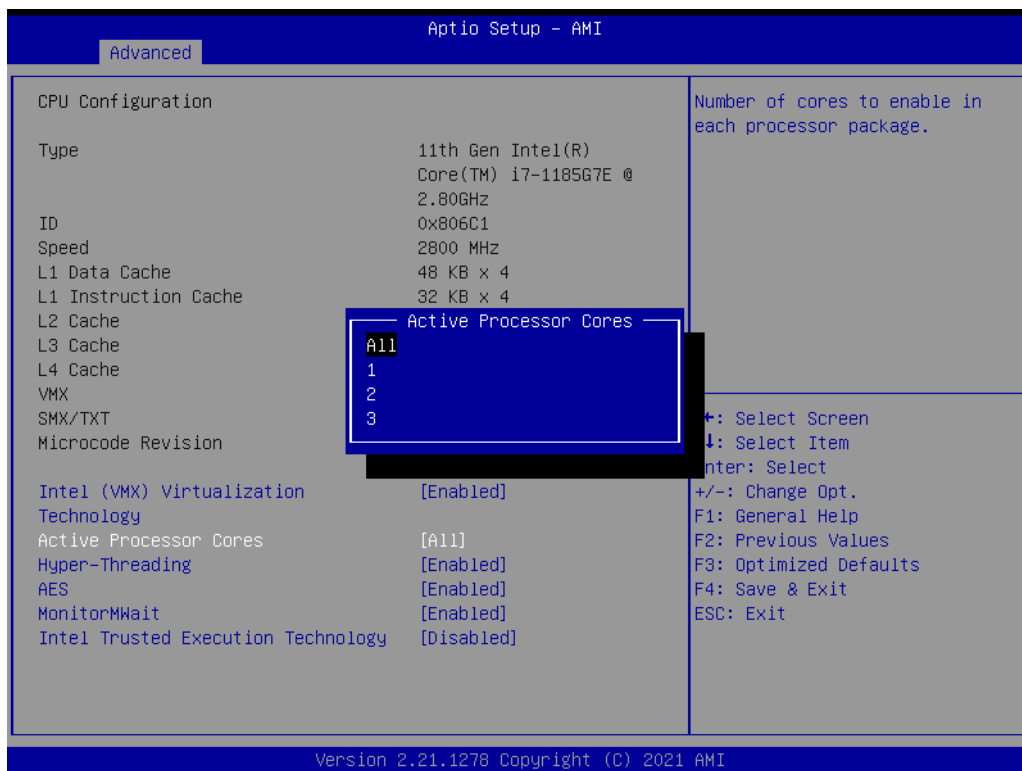

Figure 3.6 Active Processor Core Setting

- **Hyper-Threading**
- **AES**
- **MonitorMWait**
- **Intel Trusted Execution Technology**

3.4.3 Power & Performance



Figure 3.7 Power & Performance

- CPU- Power Management Control
- GT- Power Management Control



Figure 3.8 CPU- Power Management Control

- **Boot performance mode**
- **Intel® SpeedStep™**
- **Turbo Mode**
- **Config TDP Configurations**



Figure 3.9 Configurable TDP Boot Mode

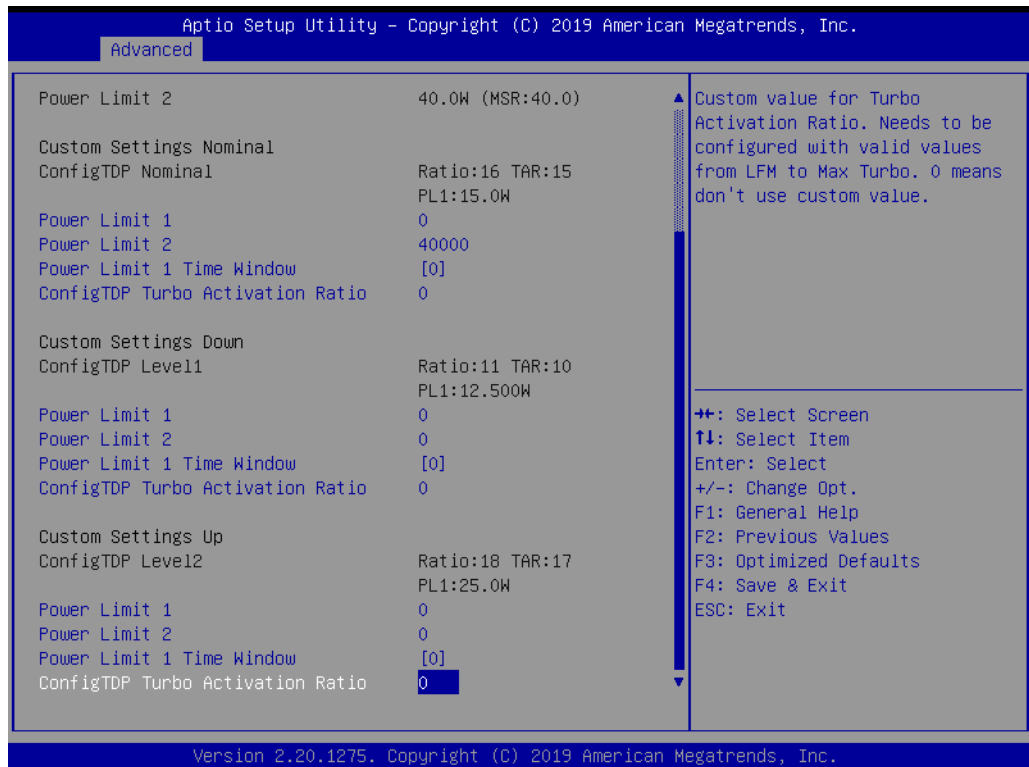

Figure 3.10 ConfigTDP Turbo Activation Ratio

GT- Power Management Control



Figure 3.11 GT- Power Management Control

- **RC6 (Render Standby)**
Check to enable render standby support.

3.4.4 PCH-FW Configuration

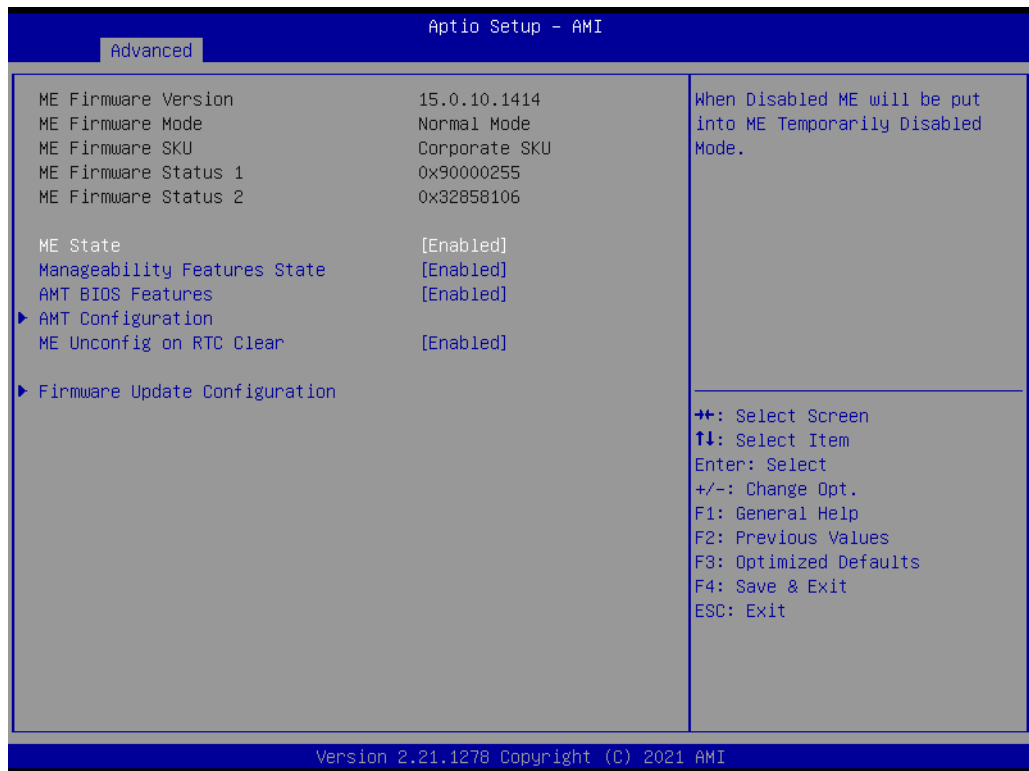

Figure 3.12 PCH-FW Configuration

- **ME Firmware**
 - Version
 - Mode
 - SKU
 - Status 1
 - Status 2
- **ME State**
- **ME Unconfig on RTC Clear**
- **Firmware Update Configuration**



Figure 3.13 Firmware Update Configuration

3.4.5 Trusted Computing



Figure 3.14 Trusted Computing

3.4.6 ACPI Settings

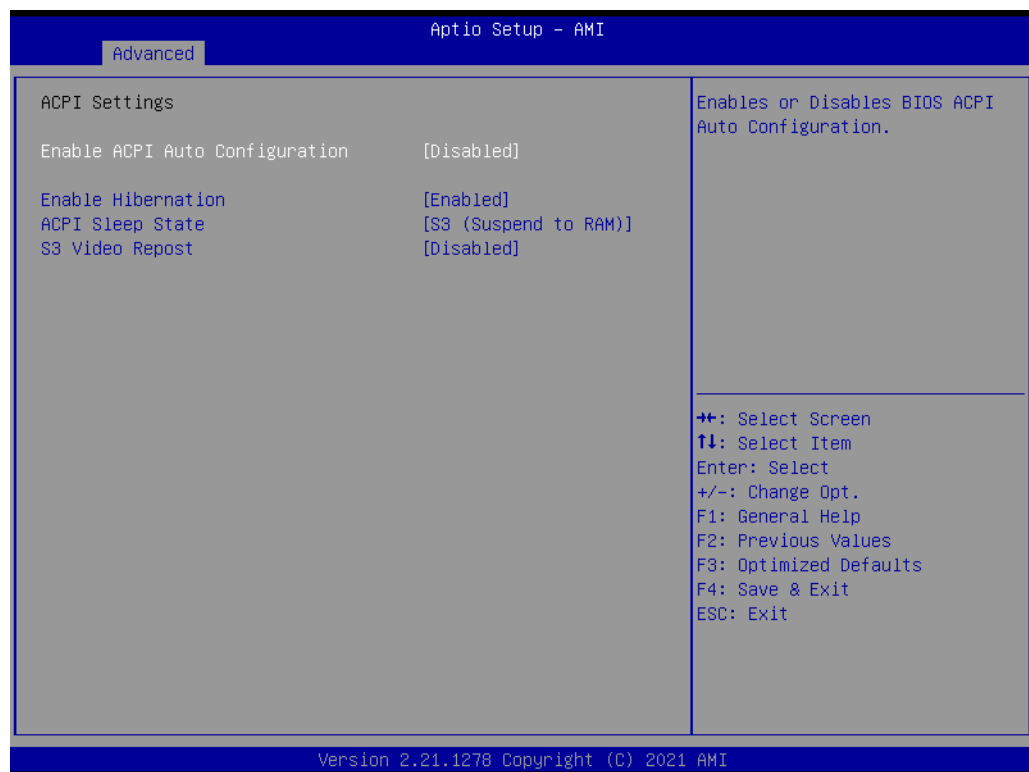

Figure 3.15 ACPI Settings

- Enable ACPI Auto Configuration
- Enable Hibernation
- ACPI Sleep State
- S3 Video Repost

3.4.7 Embedded Controller

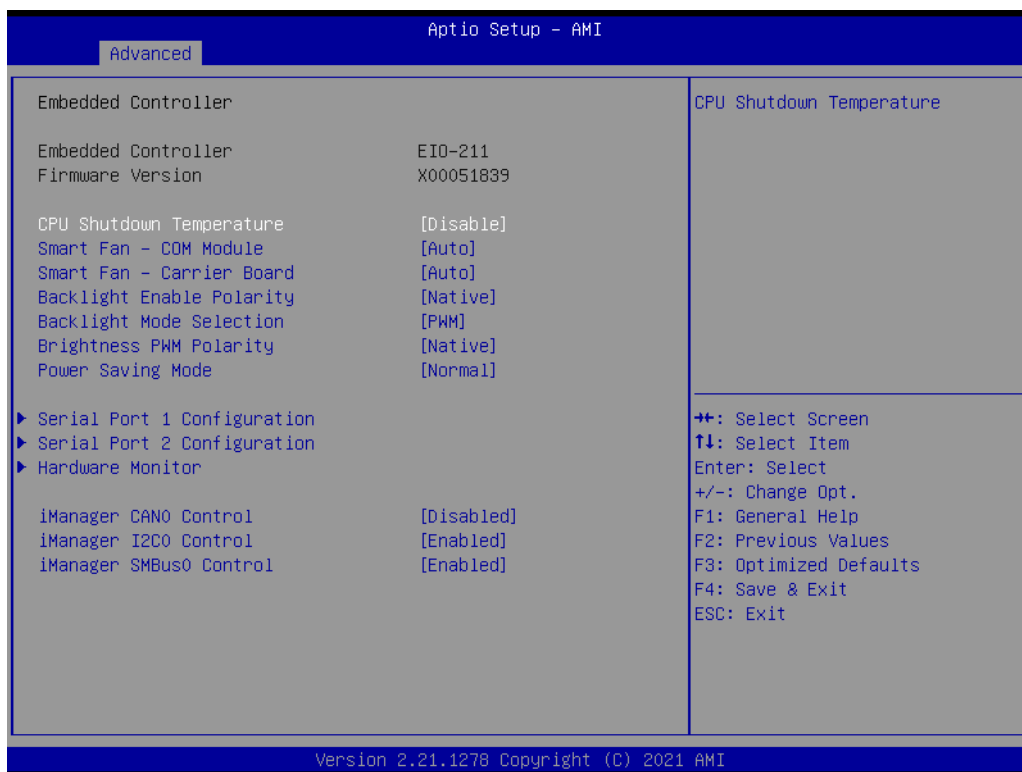

Figure 3.16 Embedded Controller

- CPU Shutdown Temperature
- Smart Fan – COM Module
- Smart Fan – Carrier Board.
- Backlight Enable Polarity
- Backlight Mode Selection
- Brightness PWM Polarity
- Power Saving Mode
- Serial Port 1 Configuration
- Serial Port 2 Configuration
- Hardware Monitor

Serial Port 1 Configuration

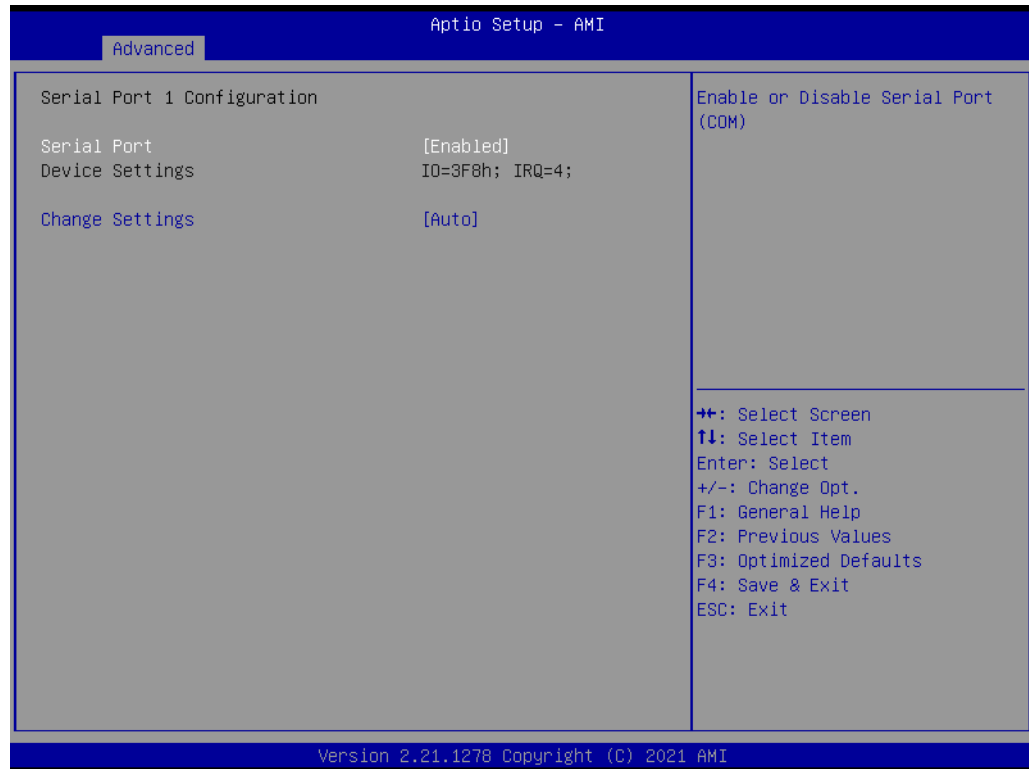

Figure 3.17 Serial Port 1 Configurations

- **Serial Port**
- **Change Settings**

Serial Port 2 Configuration

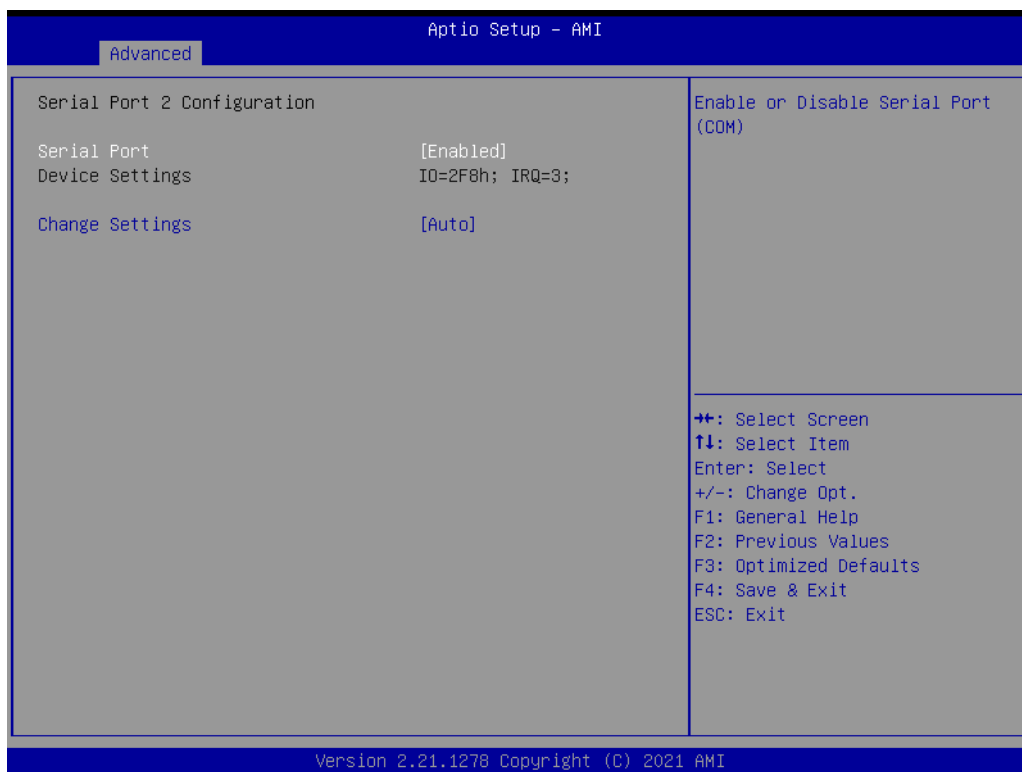

Figure 3.18 Serial Port 2 Configurations

- **Serial Port**
- **Change Settings**

Hardware Monitor

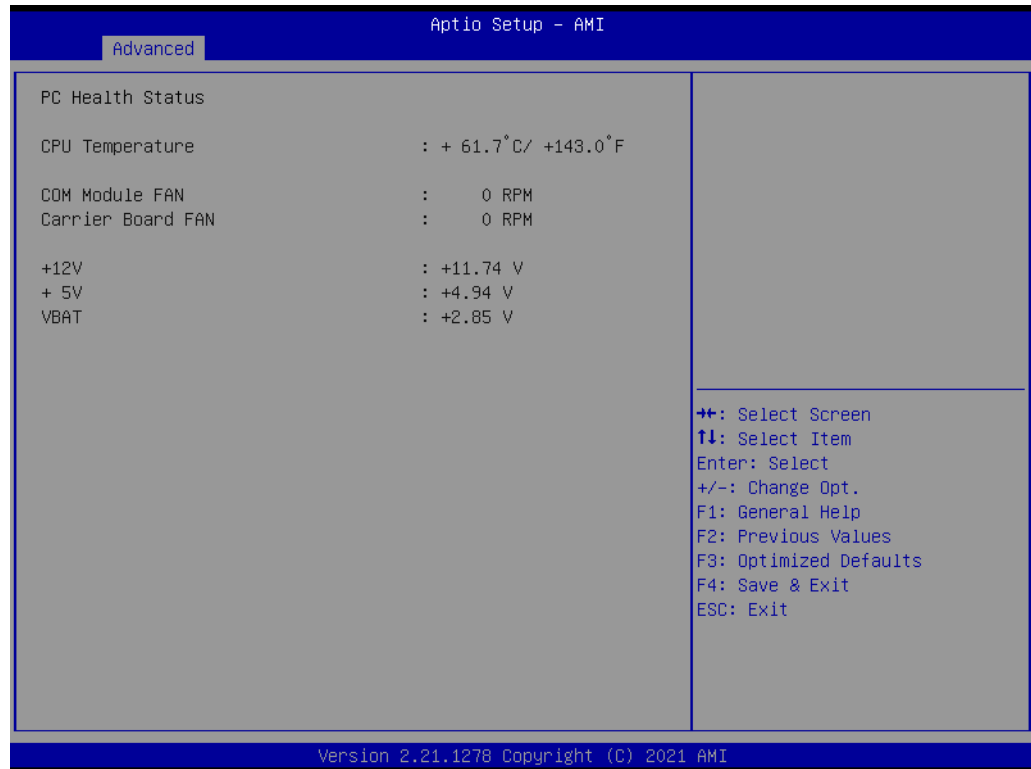

Figure 3.19 Hardware Monitor

3.4.8 Serial Port Console Redirection

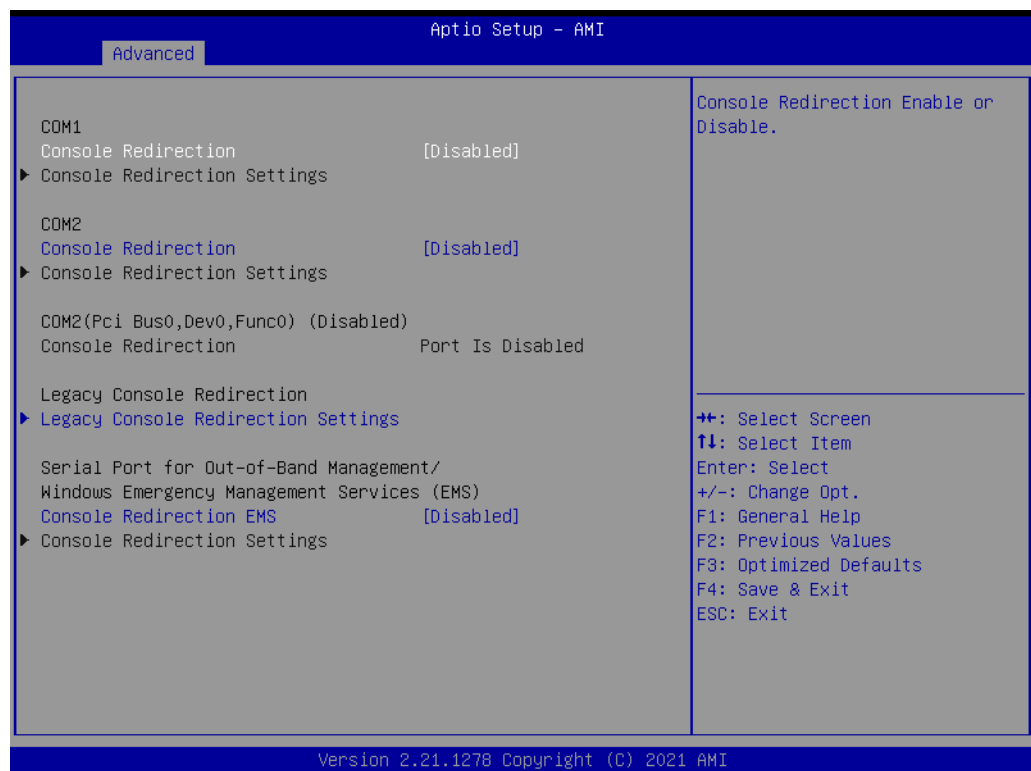

Figure 3.20 Serial Port Console Redirection

■ COM1 Console Redirection

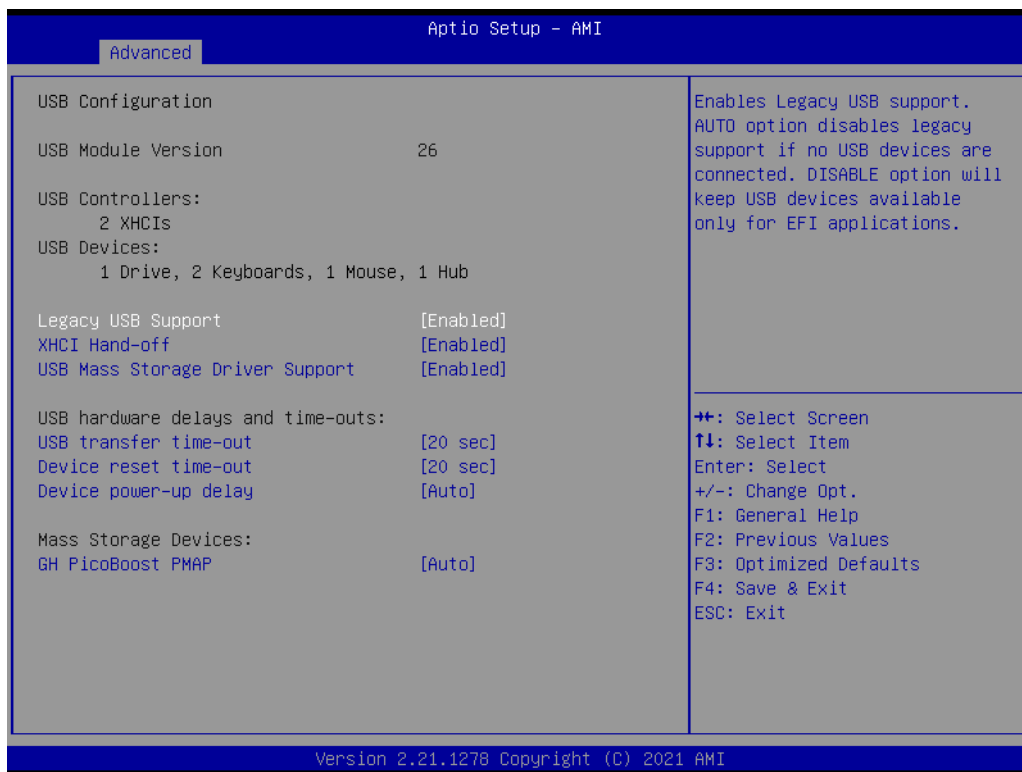

Figure 3.21 Terminal Type Settings



Figure 3.22 Terminal Type Settings

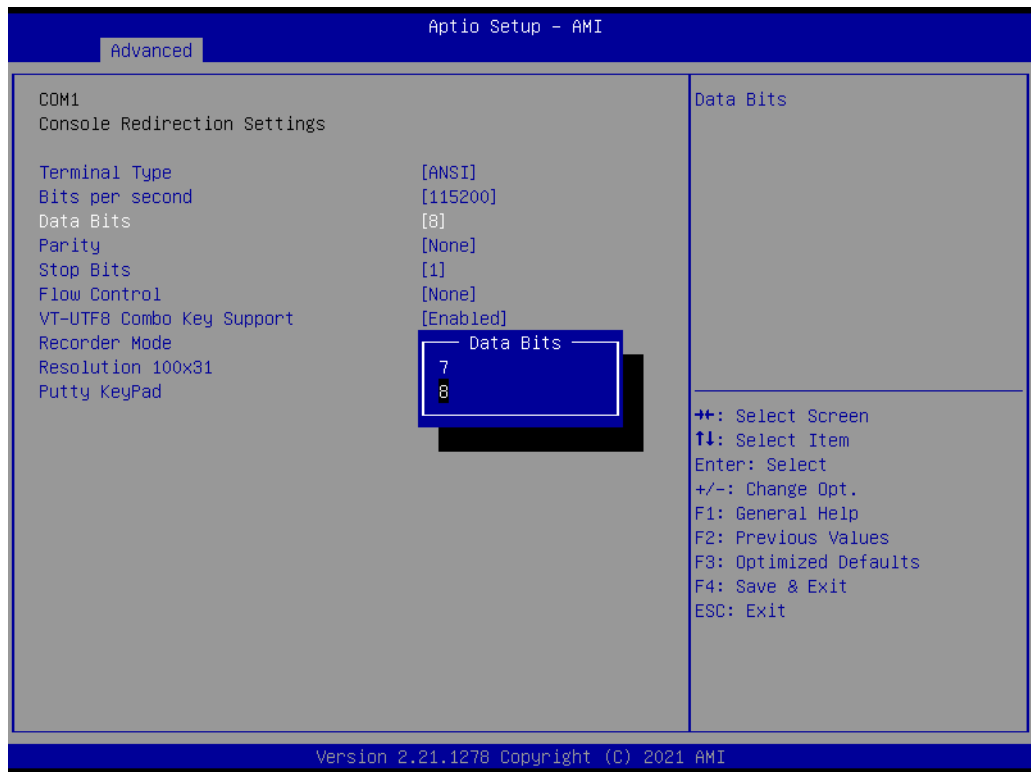

Figure 3.23 Data Bits Settings



Figure 3.24 Parity Settings

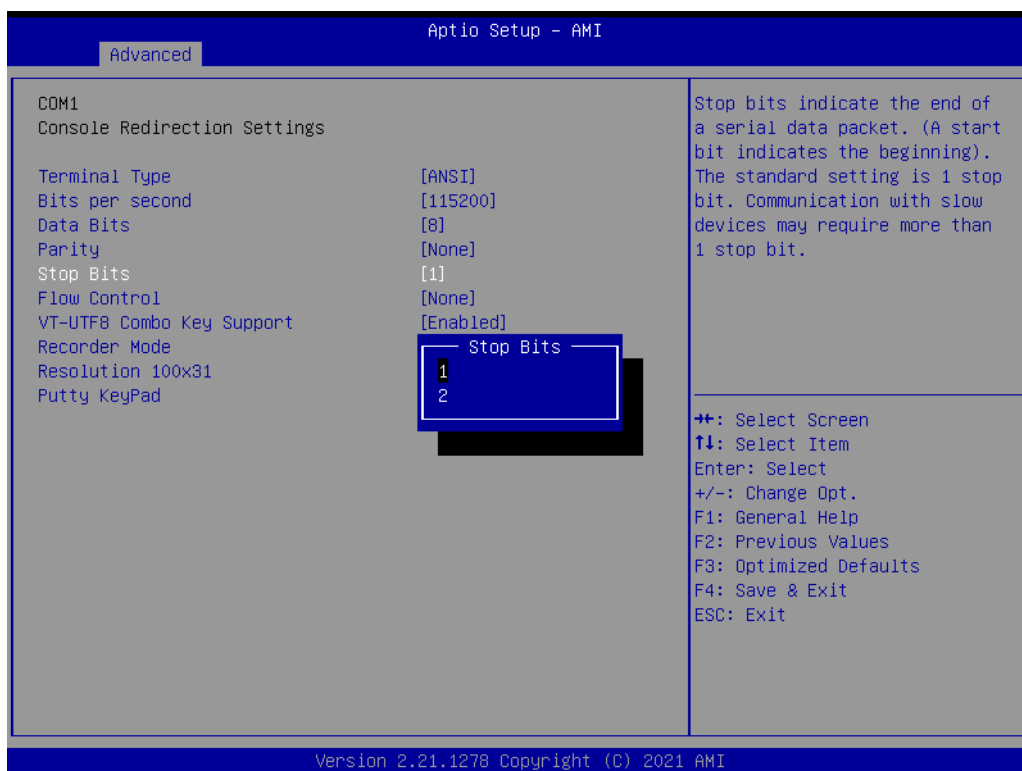

Figure 3.25 Stop Bits Settings

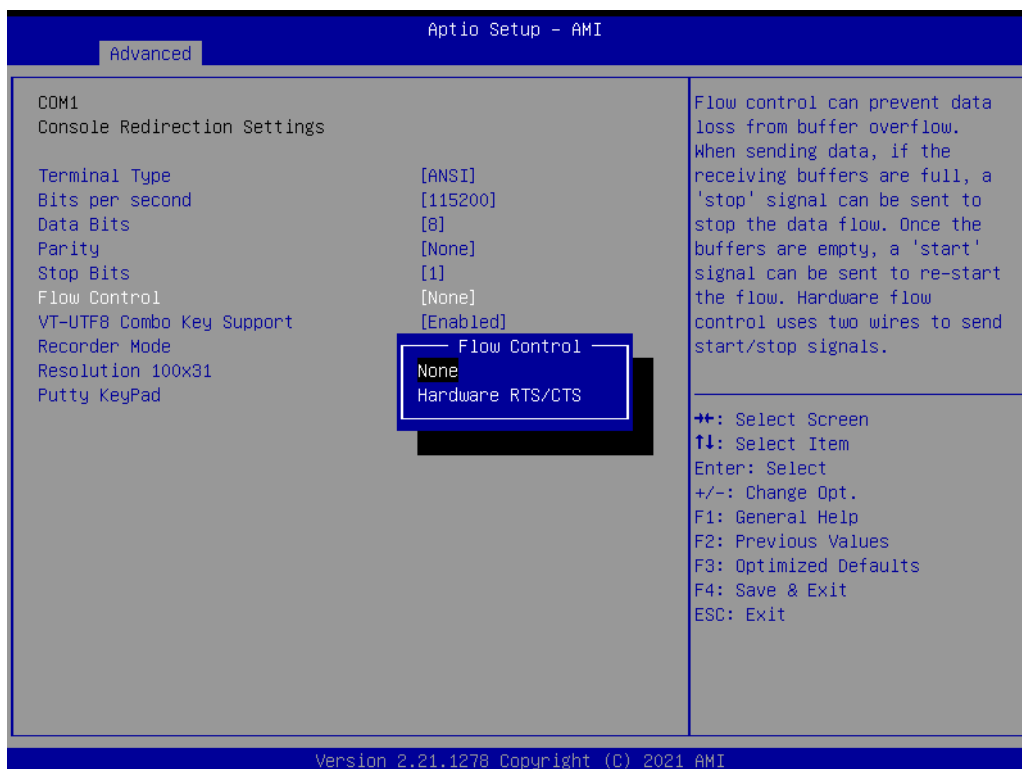

Figure 3.26 Flow Control Settings

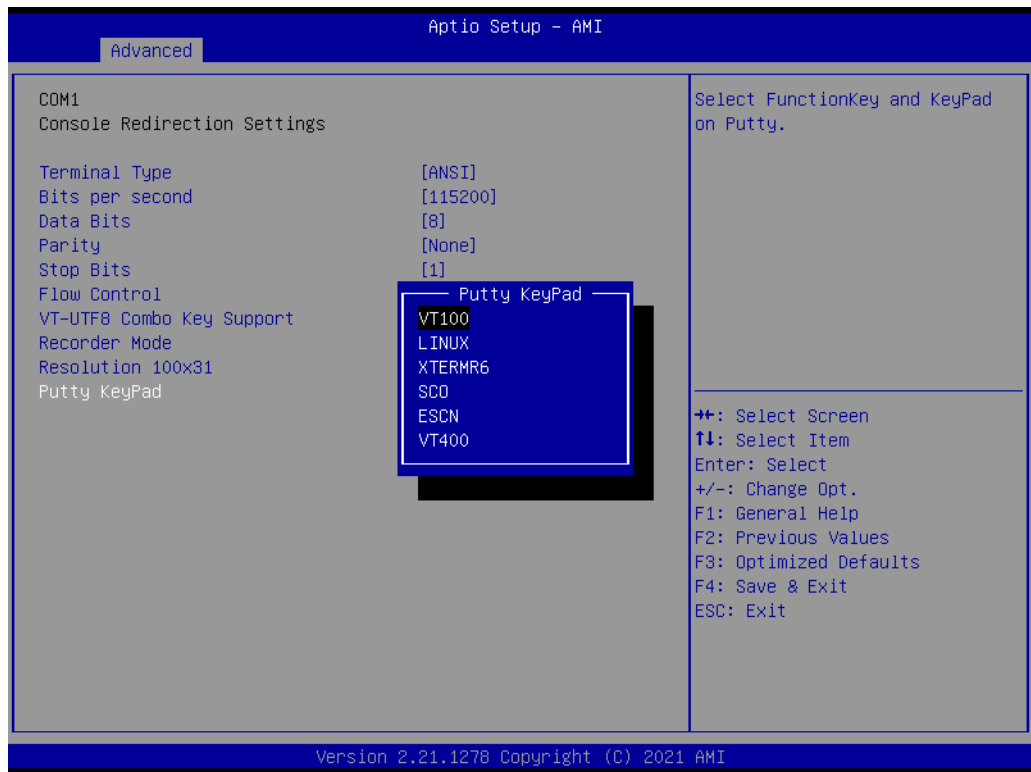

Figure 3.27 Putty KeyPad Settings

- **COM2 Console Redirection**
- **COM3 Console Redirection**
- **COM4 Console Redirection**
- **Legacy Console Redirection Settings**
- **Console Redirection**

3.4.9 USB Configuration

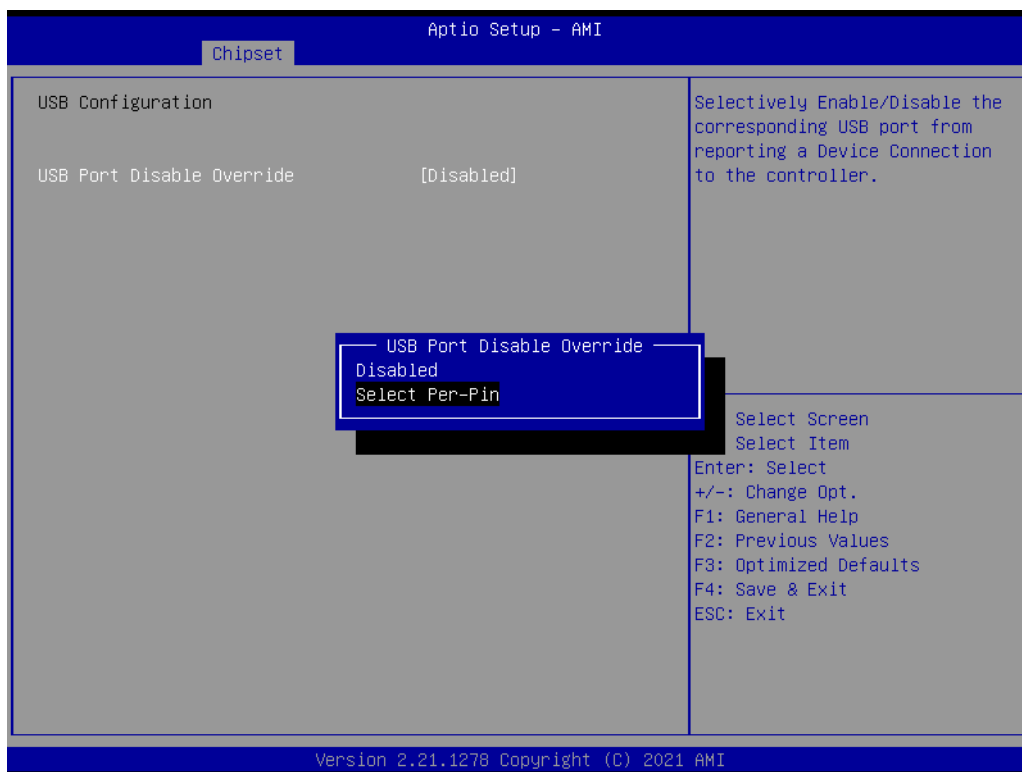

Figure 3.28 USB Configuration

- **Legacy USB Support**
Enables Legacy USB support. Auto option disables legacy support if no USB devices are connected. Disable option will keep USB devices available only for EFI applications:
 - XHCI Hand-off
 - USB Mass Storage Driver Support
 - USB transfer time-out

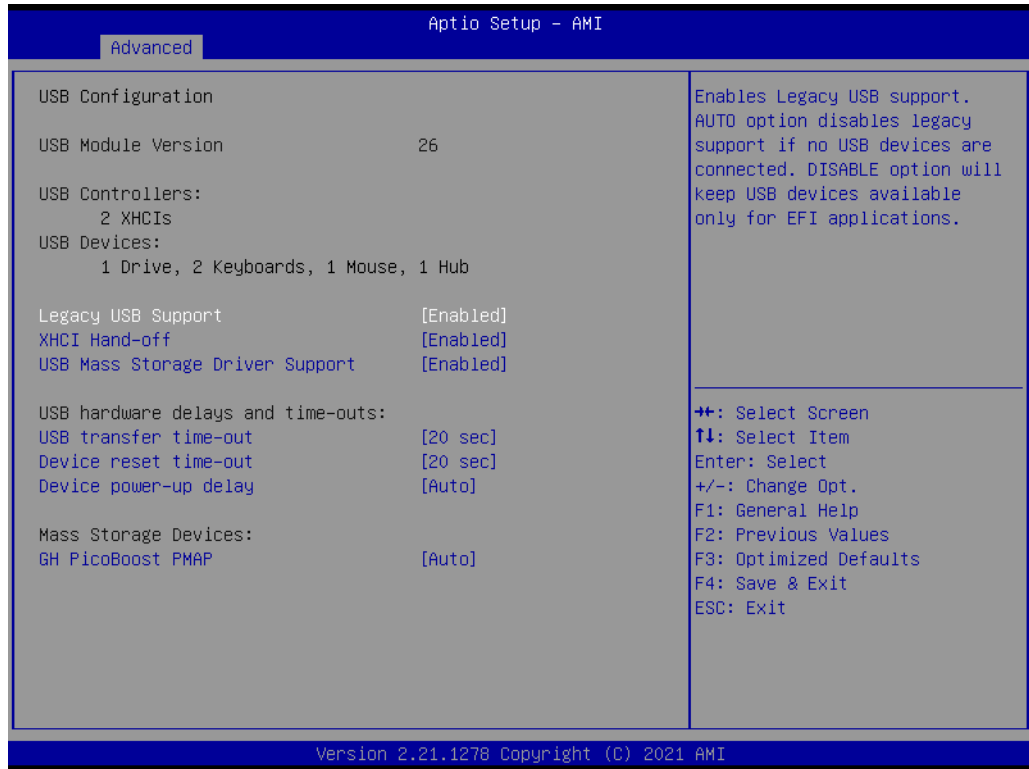

Figure 3.29 USB Transfer Time-out Settings

- **Device reset time-out**
- **Device power-up delay**

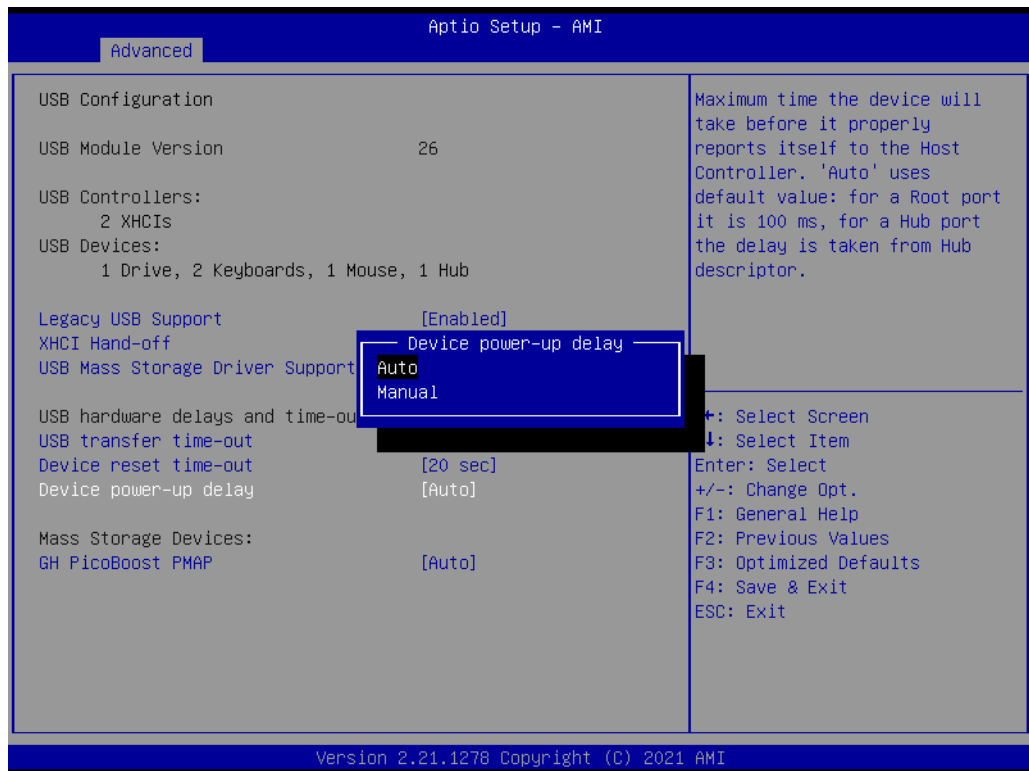

Figure 3.30 Device Power-up Delay Settings

3.4.10 NVMe Configuration

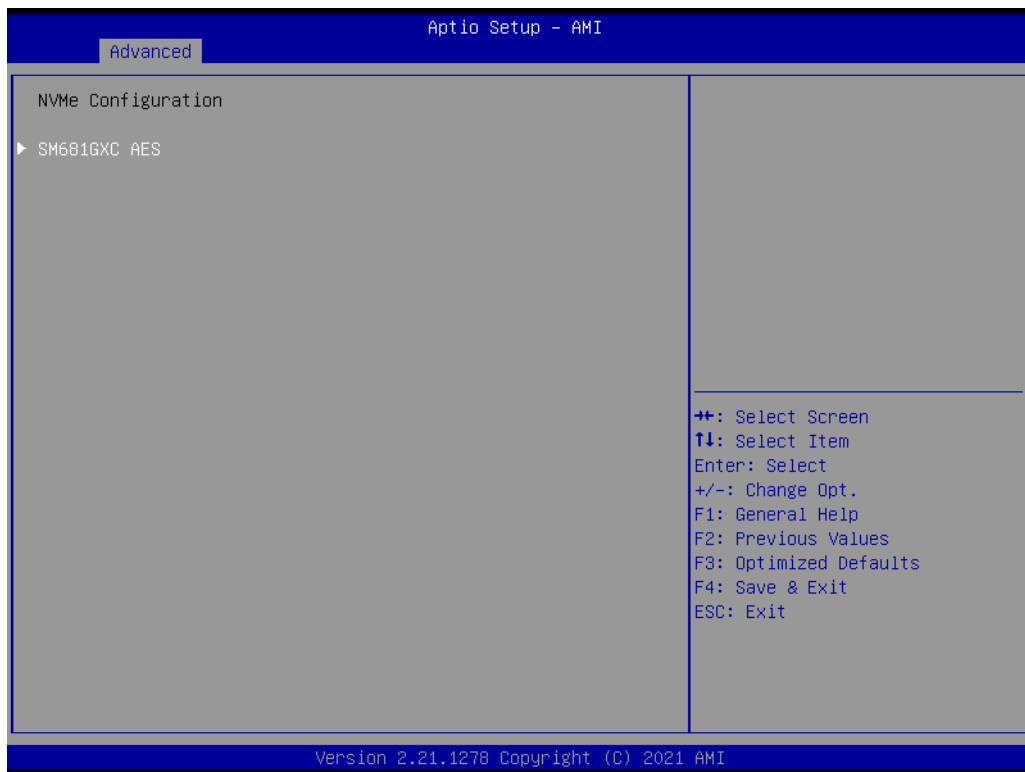

Figure 3.31 NVMe Configuration

3.4.11 Network Stack Configuration

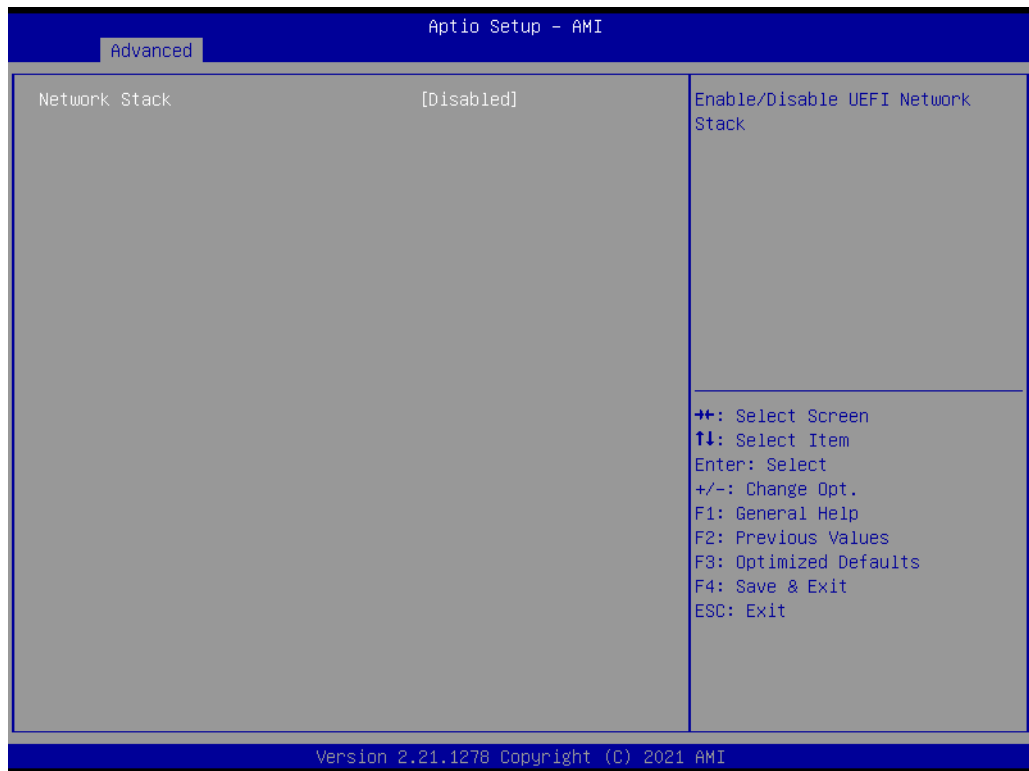

Figure 3.32 Network Stack Configuration

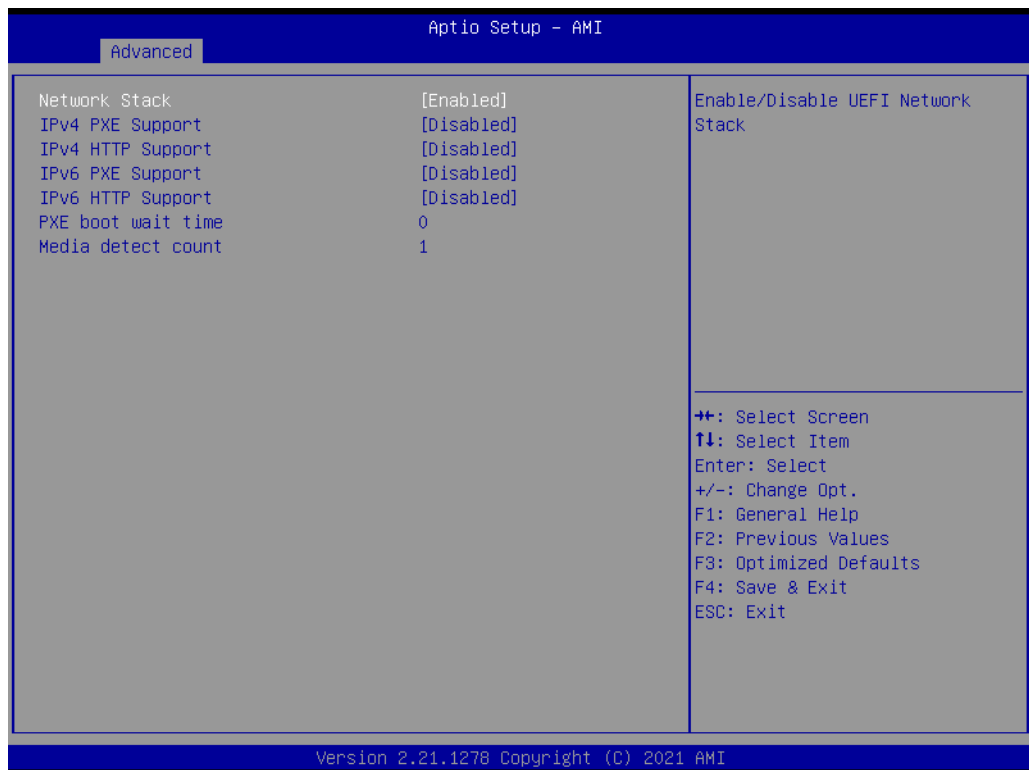

Figure 3.33 Network Stack Configuration Settings

3.5 Chipset Settings

Select the chipset tab from the SOM-6883 setup screen to enter the chipset BIOS Setup screen. You can display a chipset BIOS setup option by highlighting it using the <Arrow> keys. All Plug and Play BIOS setup options are described in this section. The Plug and Play BIOS Setup screen is shown below.

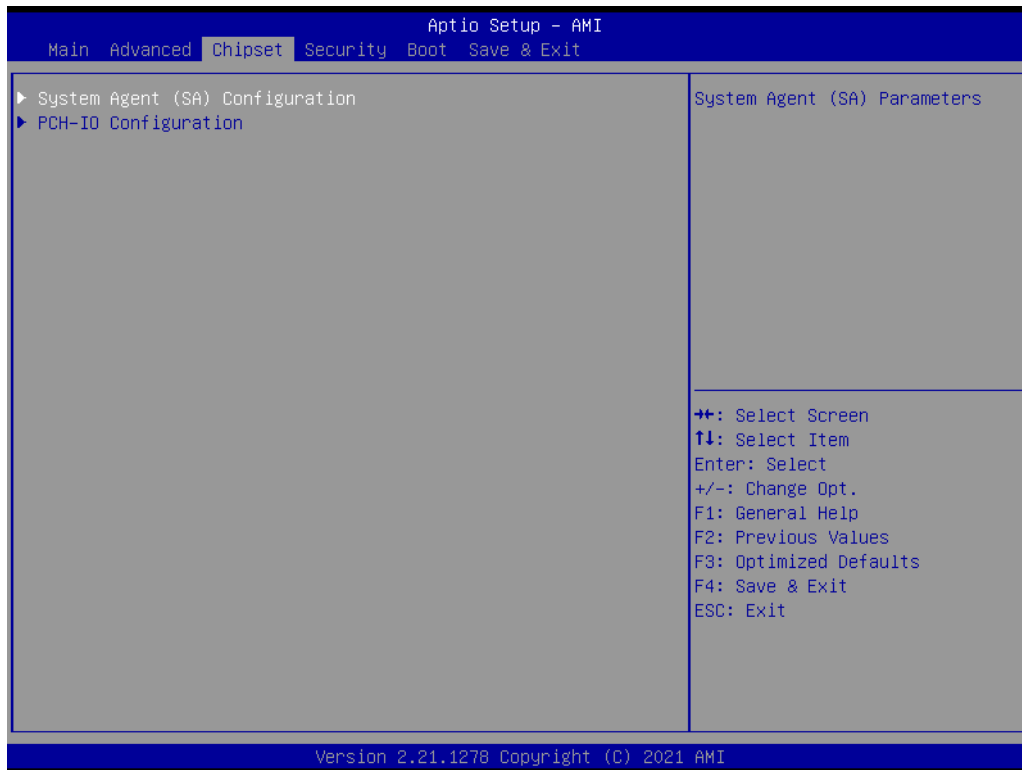

Figure 3.34 Chipset Setup

- **System Agent (SA) Configuration**
- **PCH-IO Configuration**

3.5.1 System Agent (SA) Configuration



Figure 3.35 System Agent (SA) Configuration

- Memory Configuration
- Graphics Configuration
- VT-d

Memory Configuration

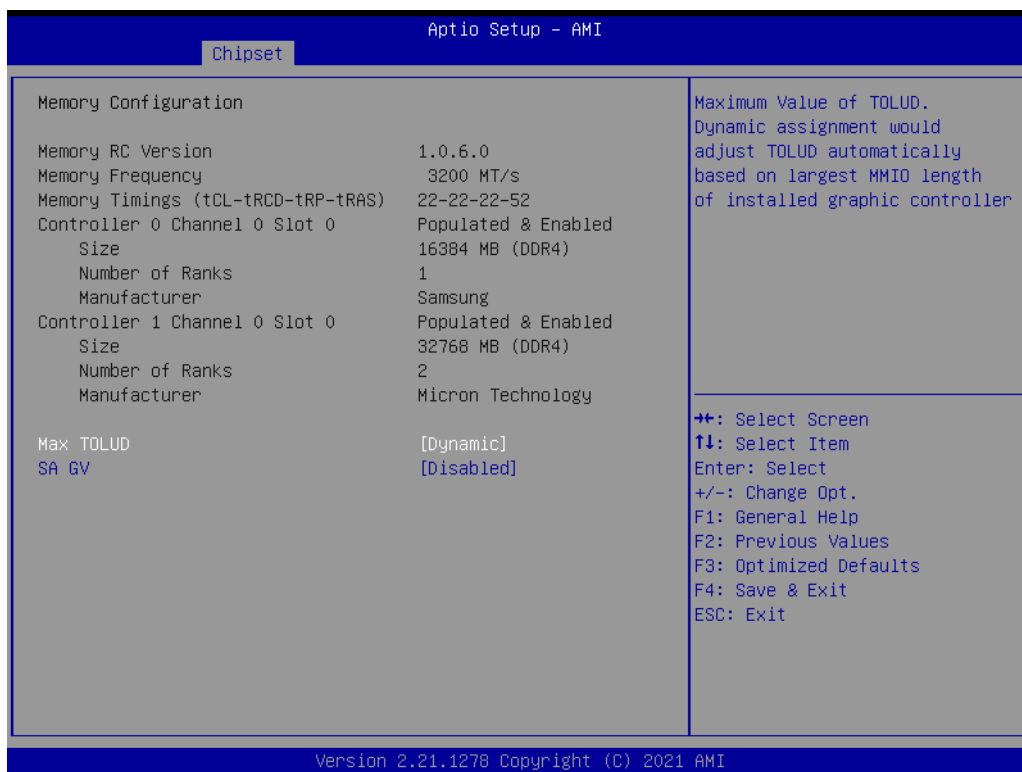

Figure 3.36 Memory Configuration

Graphics Configuration

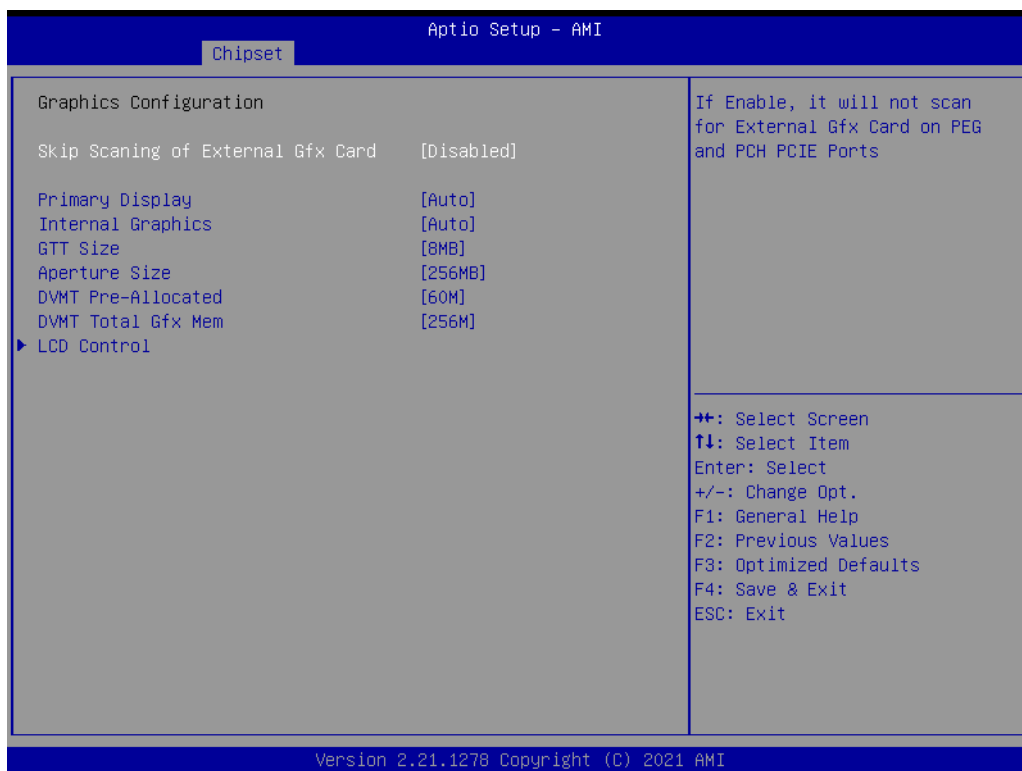

Figure 3.37 Graphics Configuration

Primary Display

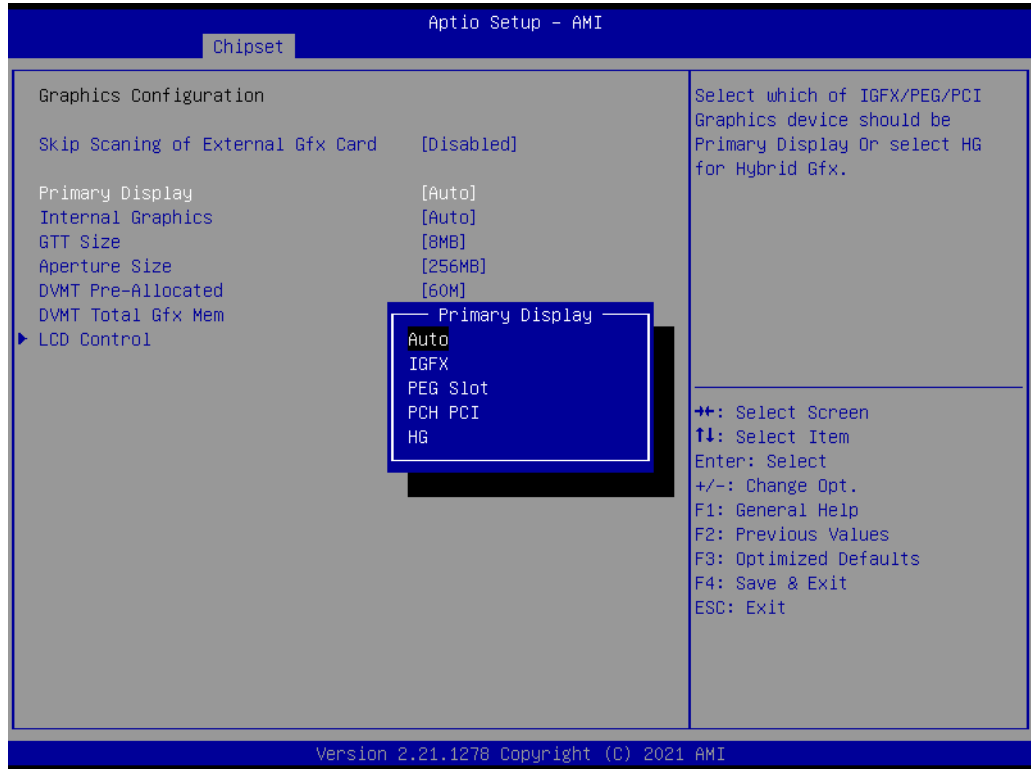

Figure 3.38 Primary Display

Internal Graphics

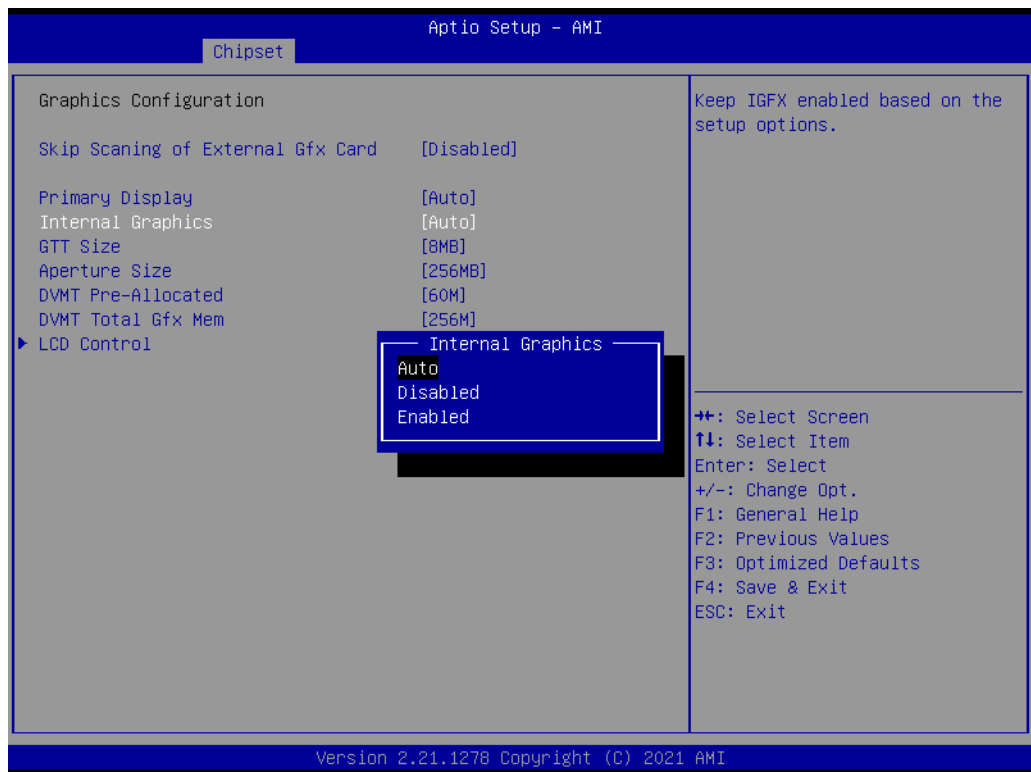

Figure 3.39 Internal Graphics Settings

GTT Size

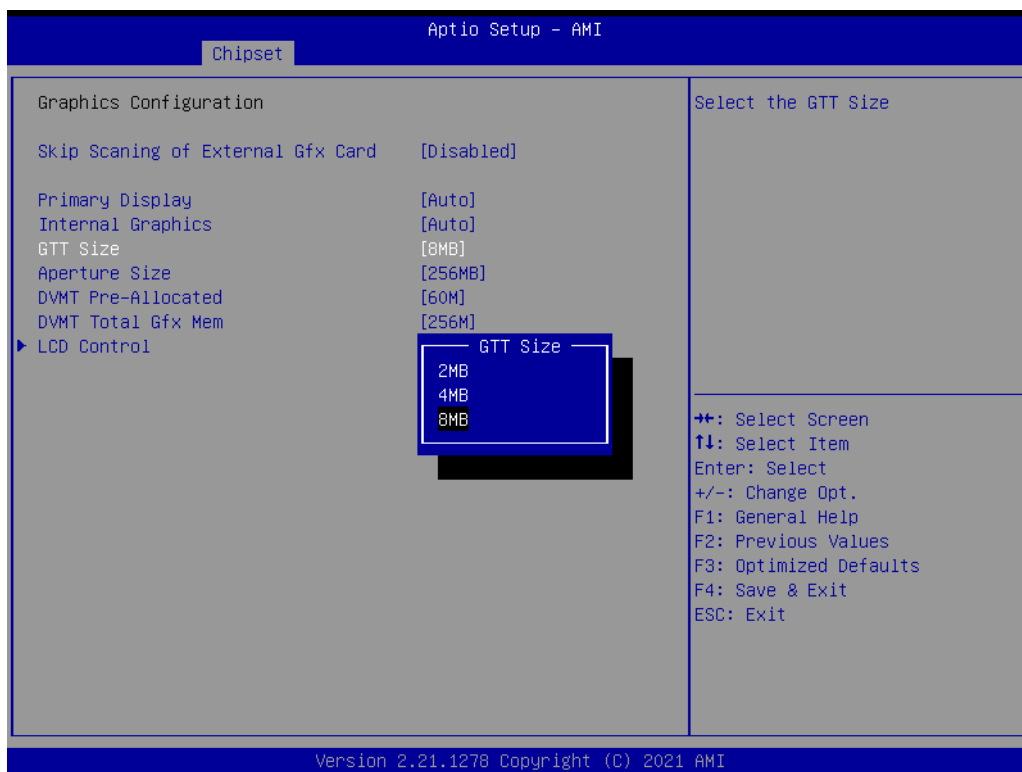

Figure 3.40 GTT Size Settings

Aperture Size

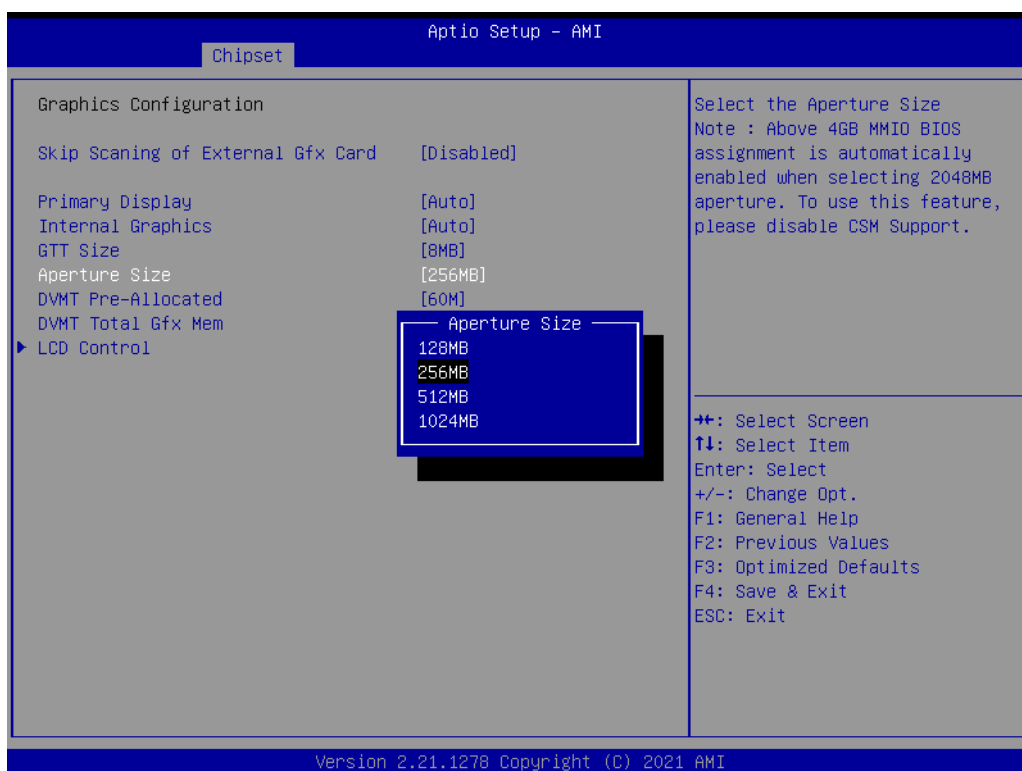

Figure 3.41 Aperture Size Settings

DVMT Pre-Allocated

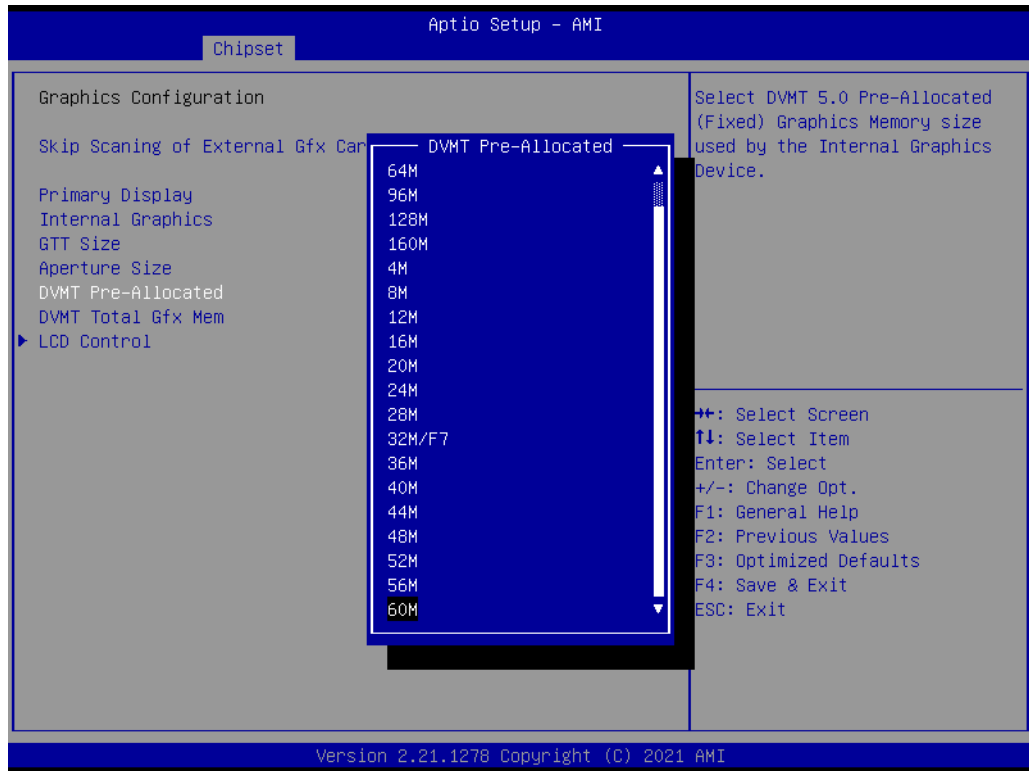

Figure 3.42 DVMT Pre-Allocated Settings

DVMT Total Gfx Mem

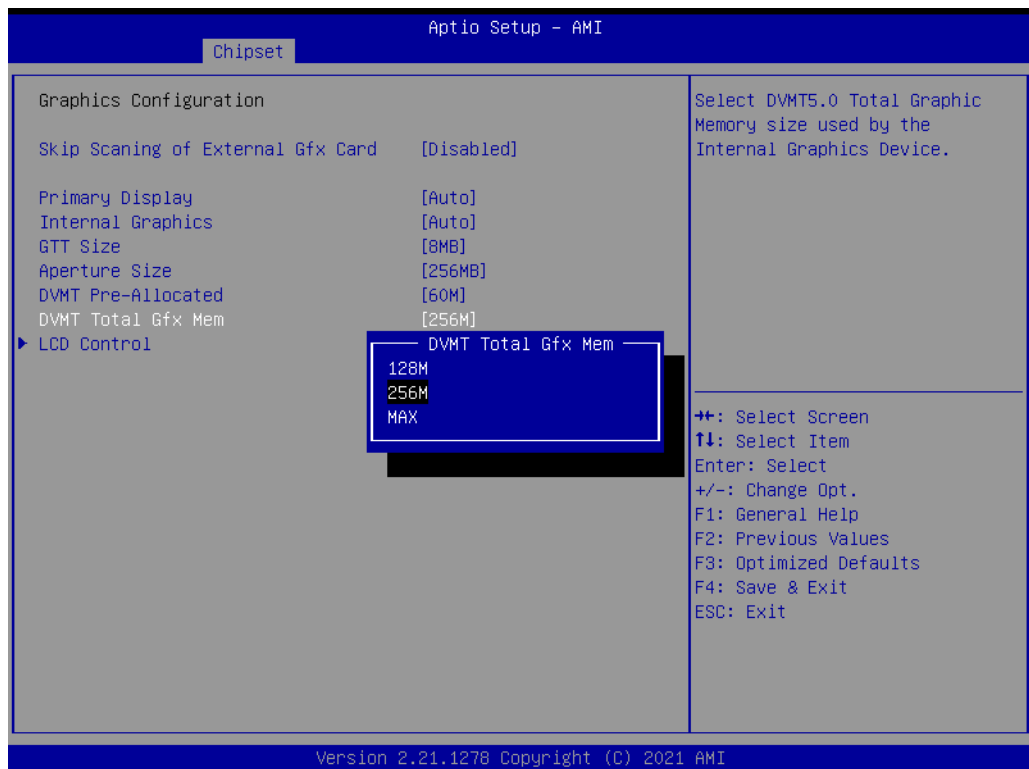

Figure 3.43 DVMT Total Gfx Mem Settings

PM Support

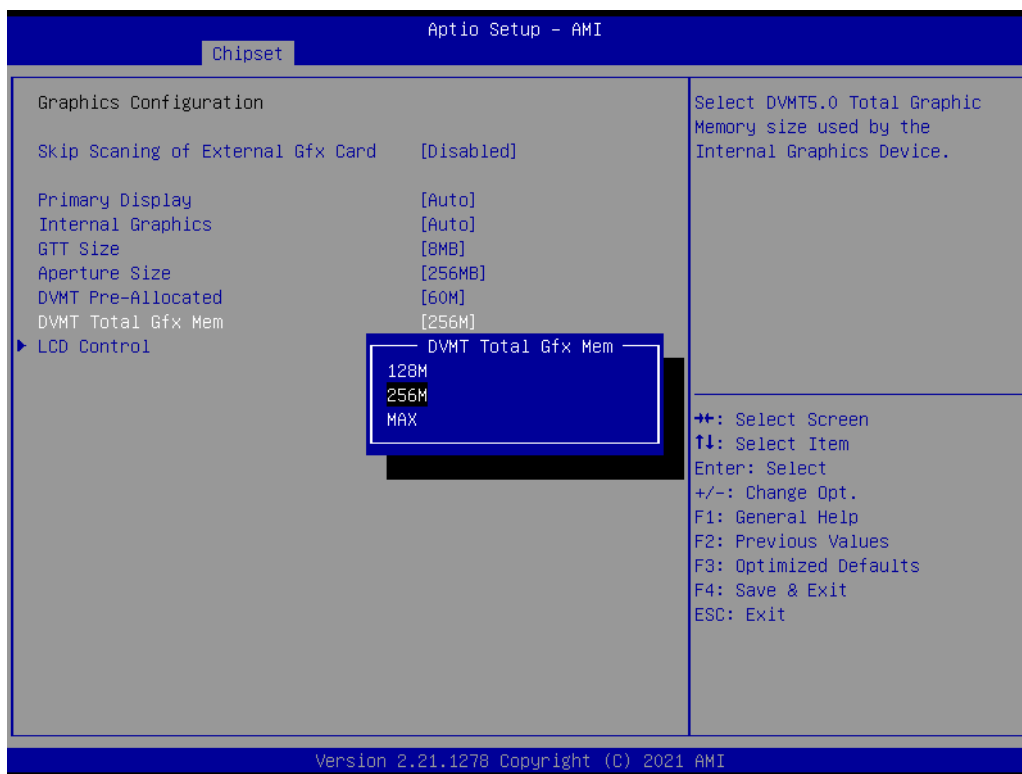

Figure 3.44 PM Support Settings

- PAVP Enable
- PAVP Enable
- LCD Control

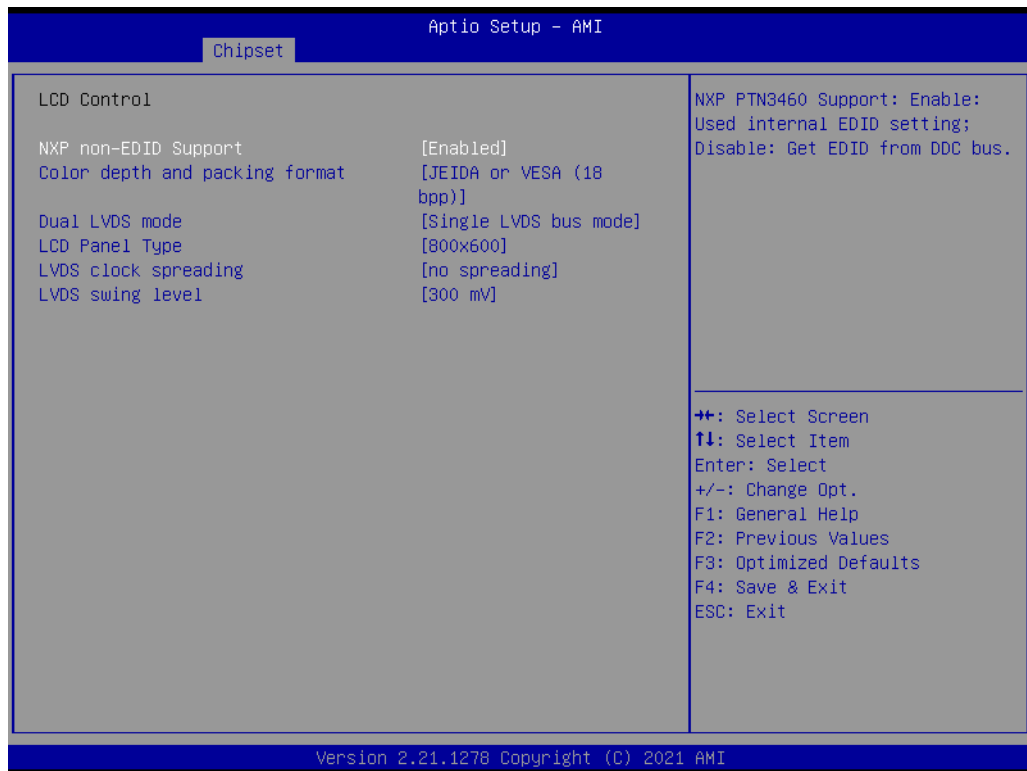

Figure 3.45 LCD Control Setting

- **NXP non-EDID Support**
- **Color depth and packing format**

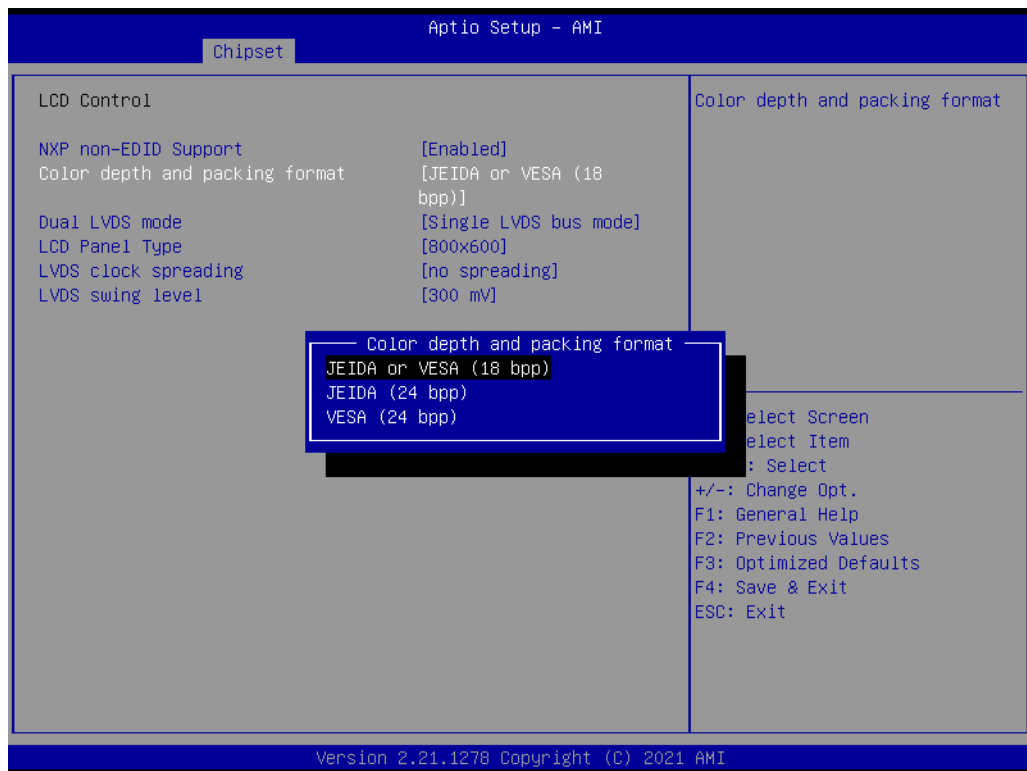

Figure 3.46 Color Depth and Packing Format Settings

Dual LVDS mode

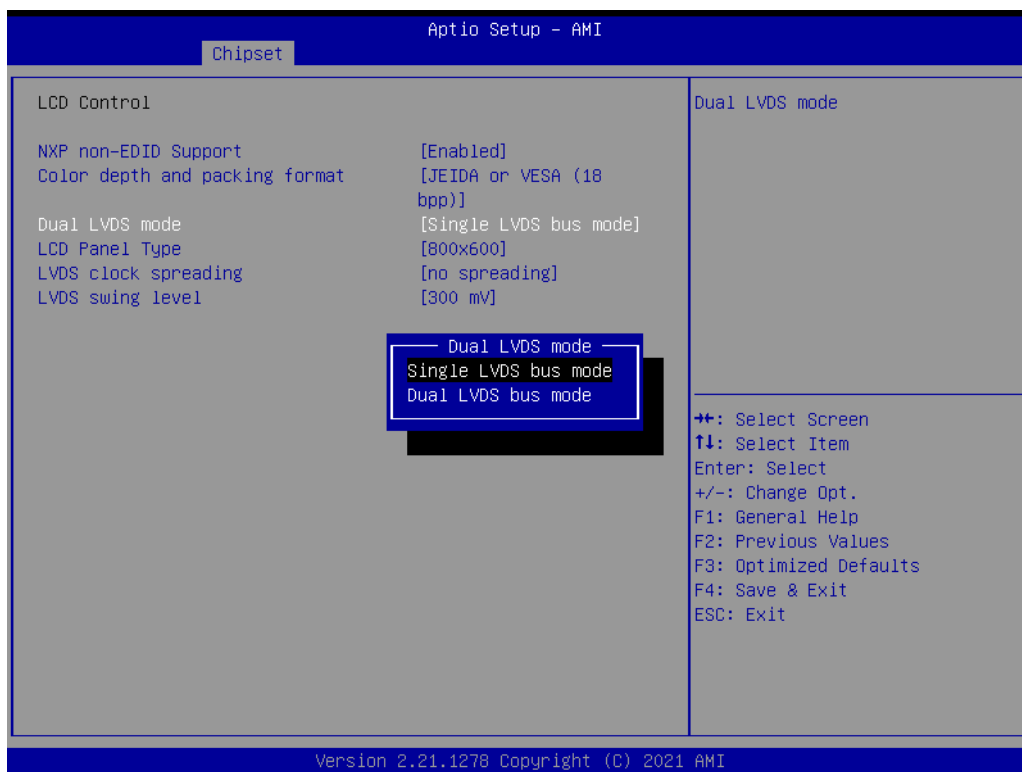

Figure 3.47 Dual LVDS Mode Settings

LCD Panel Type

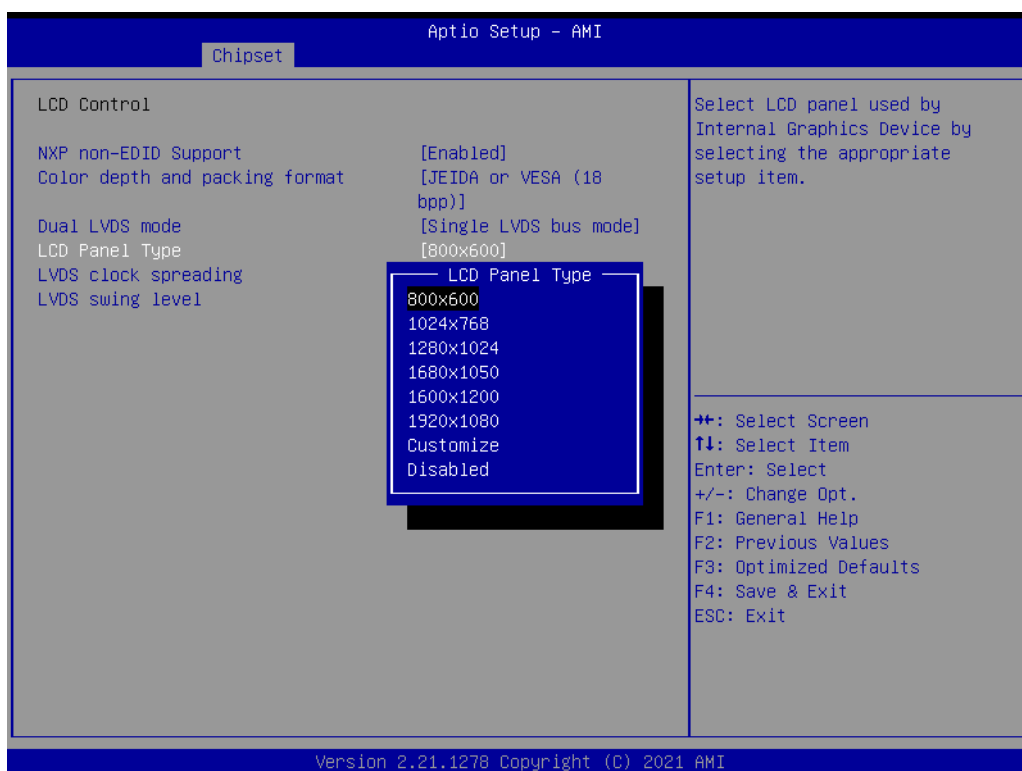

Figure 3.48 LCD Panel Type

LVDS clock spreading

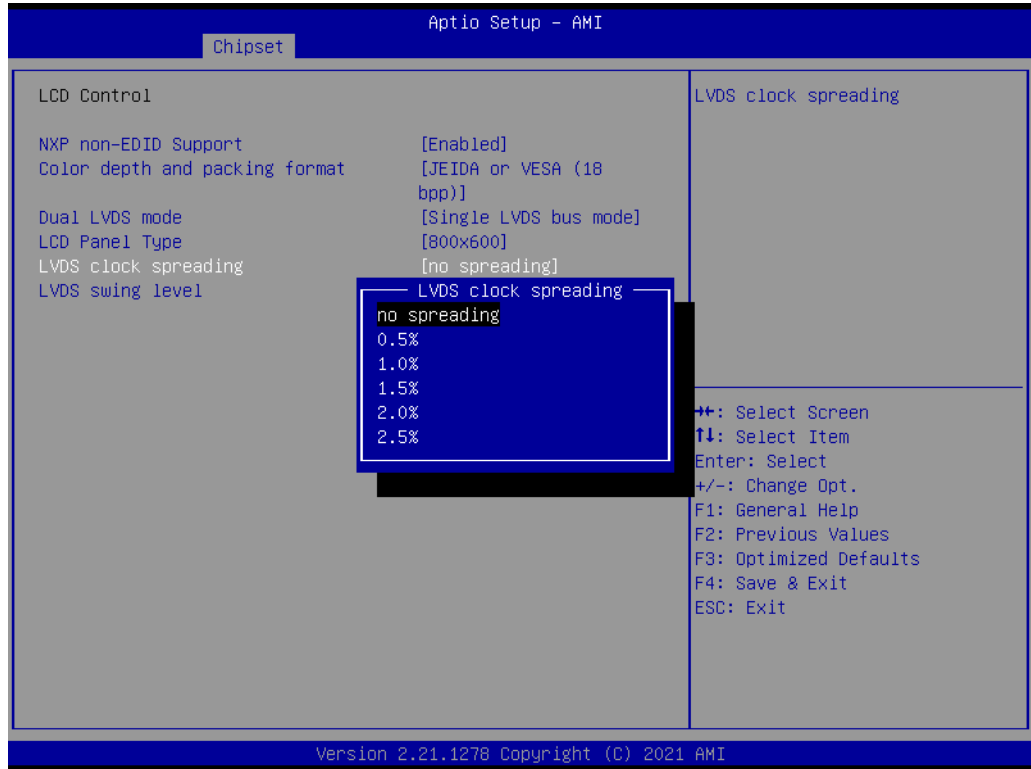

Figure 3.49 LVDS Clock Spreading Settings

LVDS swing level

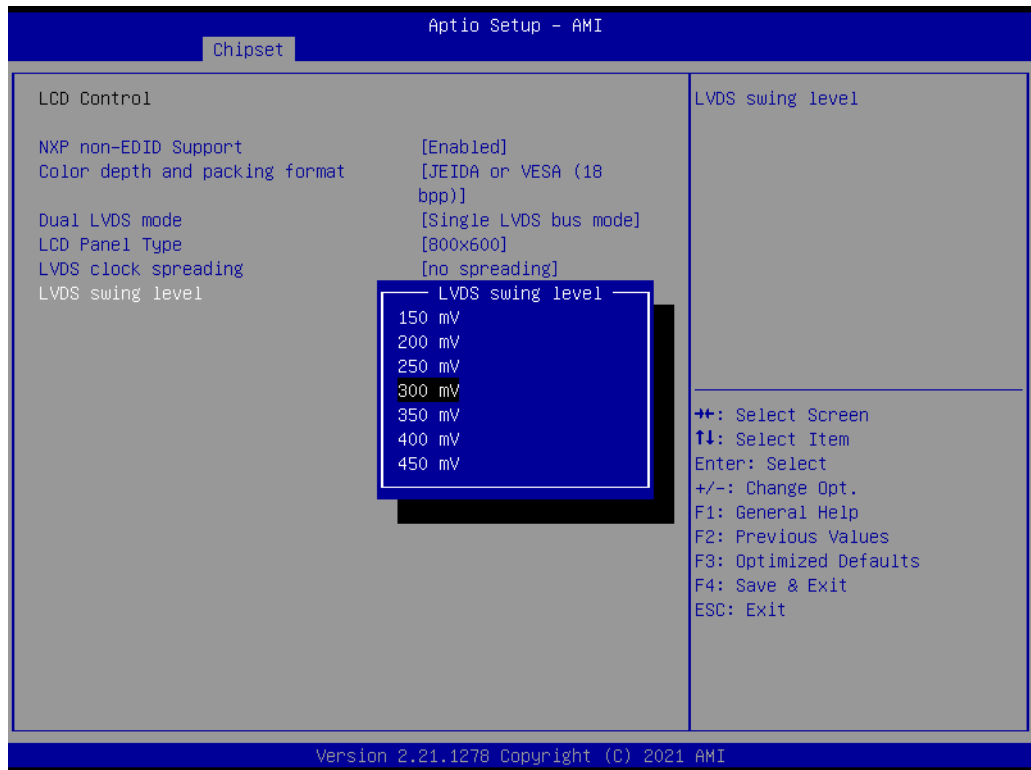

Figure 3.50 LVDS Swing Level Settings

3.5.2 PCH-IO Configuration



Figure 3.51 PCH-IO Configuration

- **PCI Express Configuration**
- **SATA And RST Configuration**
- **USB Configuration**
- **Security Configuration**
- **HD Audio Configuration**
- **SerialIo Configuration**
- **SCS Configuration**
 - PCH LAN Controller
 - Wake on LAN Enable
 - Serial IRQ Mode
 - State After G3
 - PCIe PII SSC

PCI Express Configuration

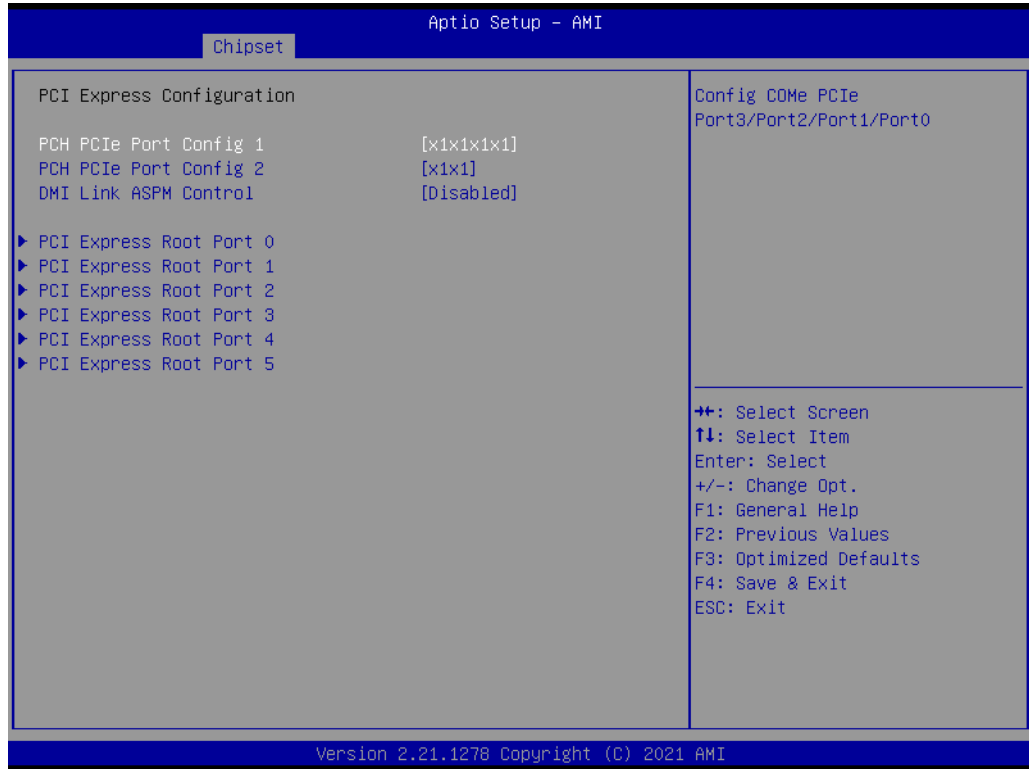

Figure 3.52 PCI Express Configuration

- **PCI Express Root Port 0**
PCI Express Root Port 0 settings.
- **PCI Express Root Port 1**
PCI Express Root Port 1 settings.
- **PCI Express Root Port 2**
PCI Express Root Port 2 settings.
- **PCI Express Root Port 3**
PCI Express Root Port 3 settings.
- **PCI Express Root Port 4**
PCI Express Root Port 4 settings.
- **PCI Express Root Port 5**
PCI Express Root Port 2 settings.

PCI Express Root Port 0 Configuration

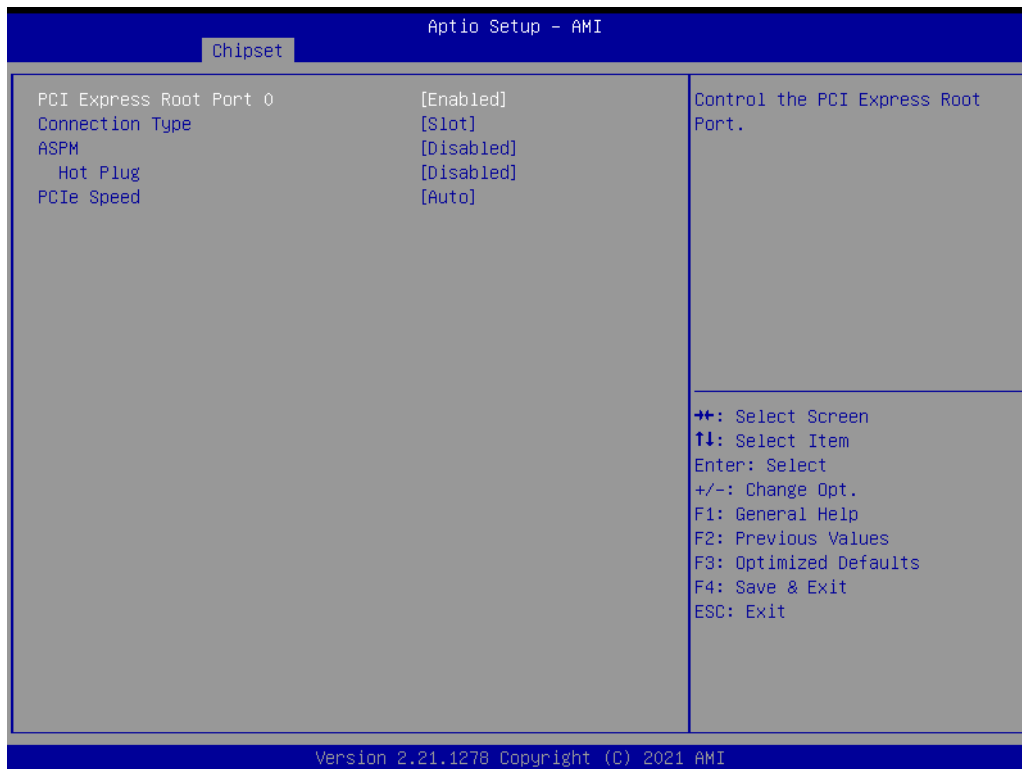

Figure 3.53 PCI Express Root Port 0 Configuration

- **PCI Express Root Port 0**
- **ASPM**
 - Hot Plug
- **PCIe Speed**

SATA And RST Configuration

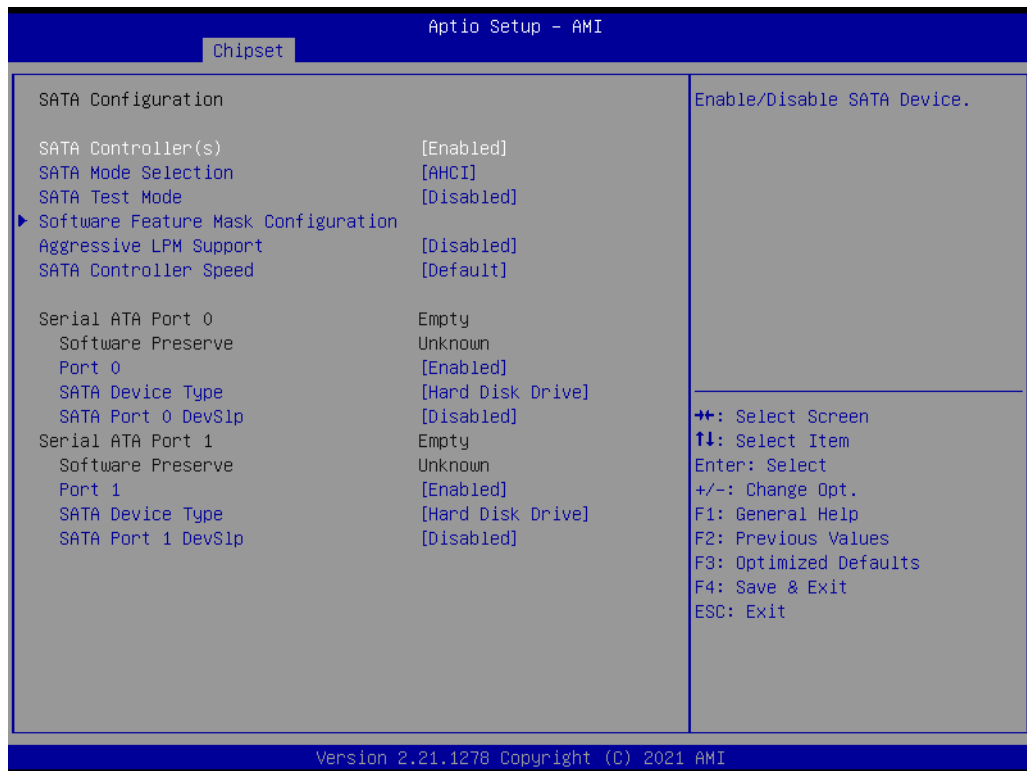

Figure 3.54 SATA And RST Configuration

- **SATA Controller(s)**
Enable/Disable SATA Device.
- **SATA Mode Selection**
Determines how SATA controller(s) operate.
- **Software Feature Mask Configuration**
Enable/Disable SATA Device.
- **Aggressive LPM Support**
- **SATA Controller Speed**
Indicates the maximum speed the SATA controller can support.
- **Port 0**
Enable or Disable SATA port.
 - SATA Device Type
 - SATA Port 0 DevSlp
- **Port 1**
Enable or Disable SATA port.
- **SATA Device Type**
- **SATA Port 0 DevSlp**

USB Configuration

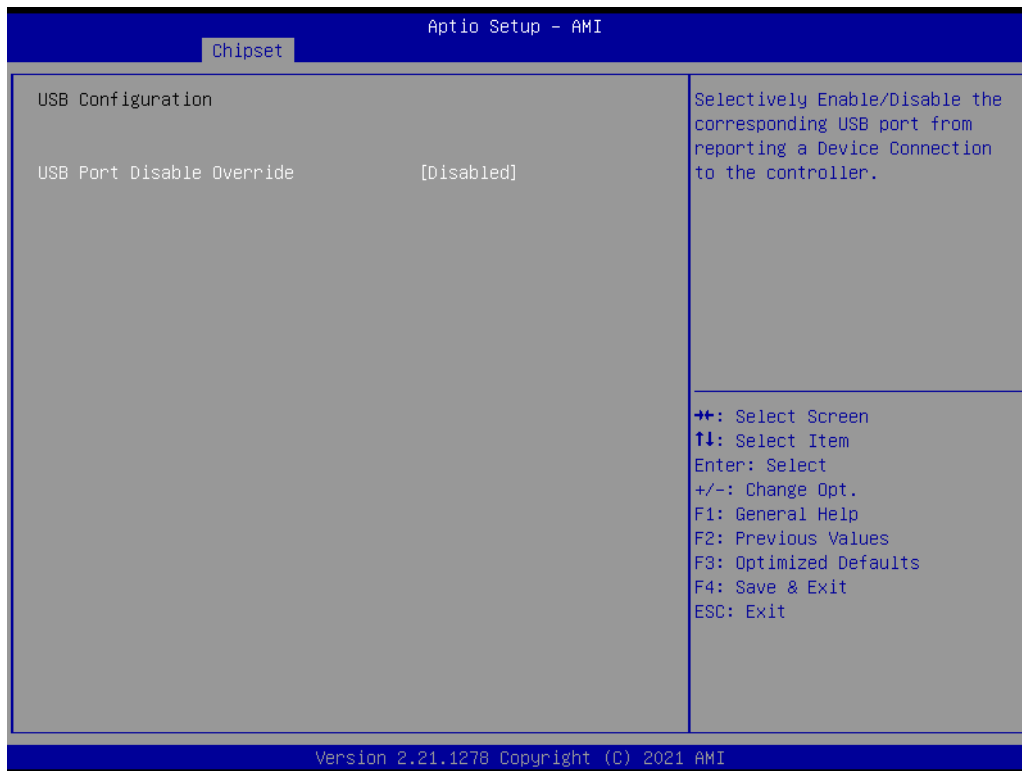

Figure 3.55 USB Configuration

■ XHCI Disable Compliance Mode

Options to disable Compliance Mode.

Default is False to not disable Compliance Mode. Set TRUE to disable Compliance Mode.

Security Configuration

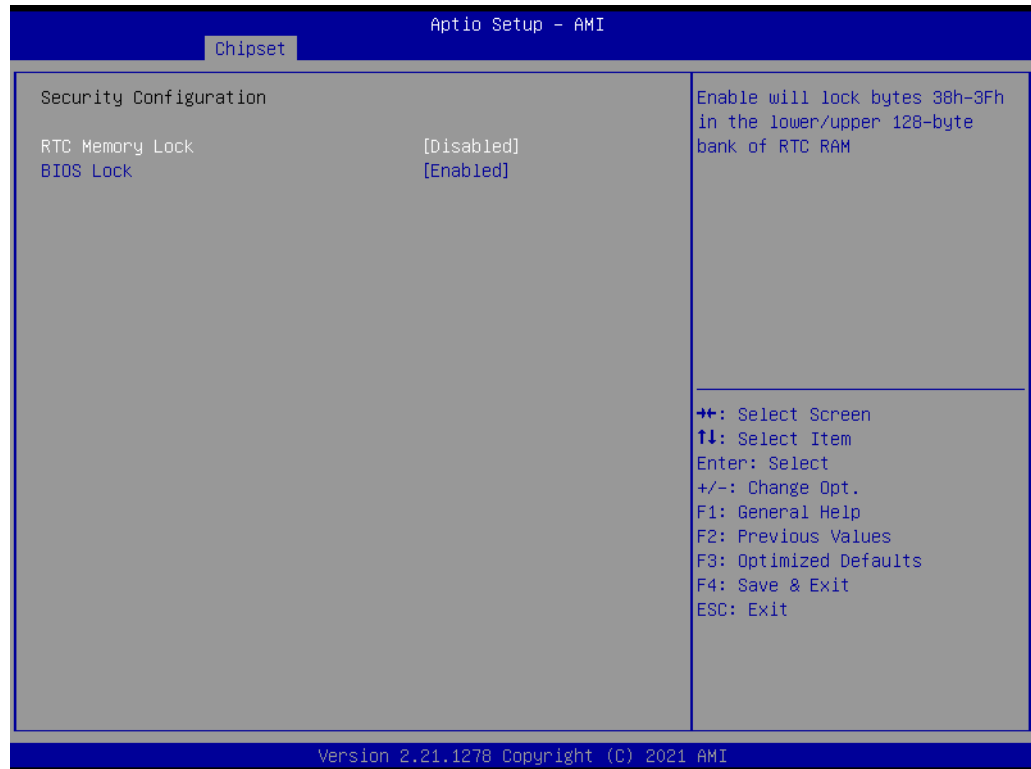

Figure 3.56 Security Configuration Settings

HD Audio Configuration

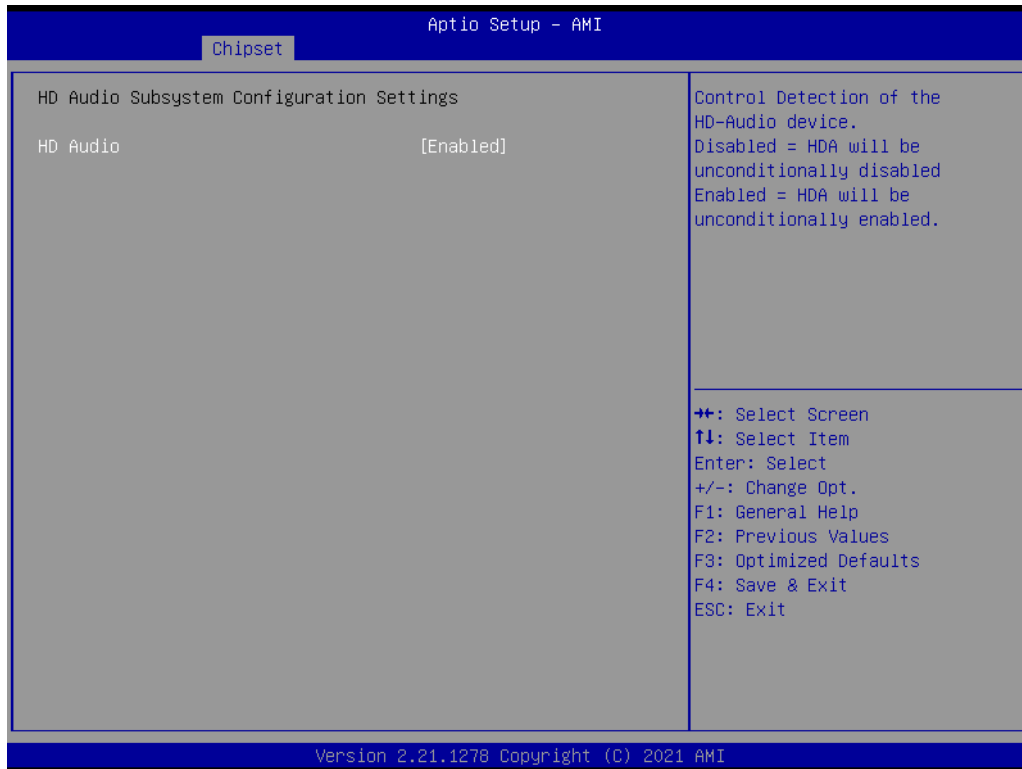

Figure 3.57 HD Audio Configuration

■ HD Audio

Control Detection of the HD-Audio device.

- Disabled= HDA will be unconditionally disabled
- Enabled= HDA will be unconditionally enabled
- Auto= HDA will be enabled if present, disabled otherwise

Security Configuration

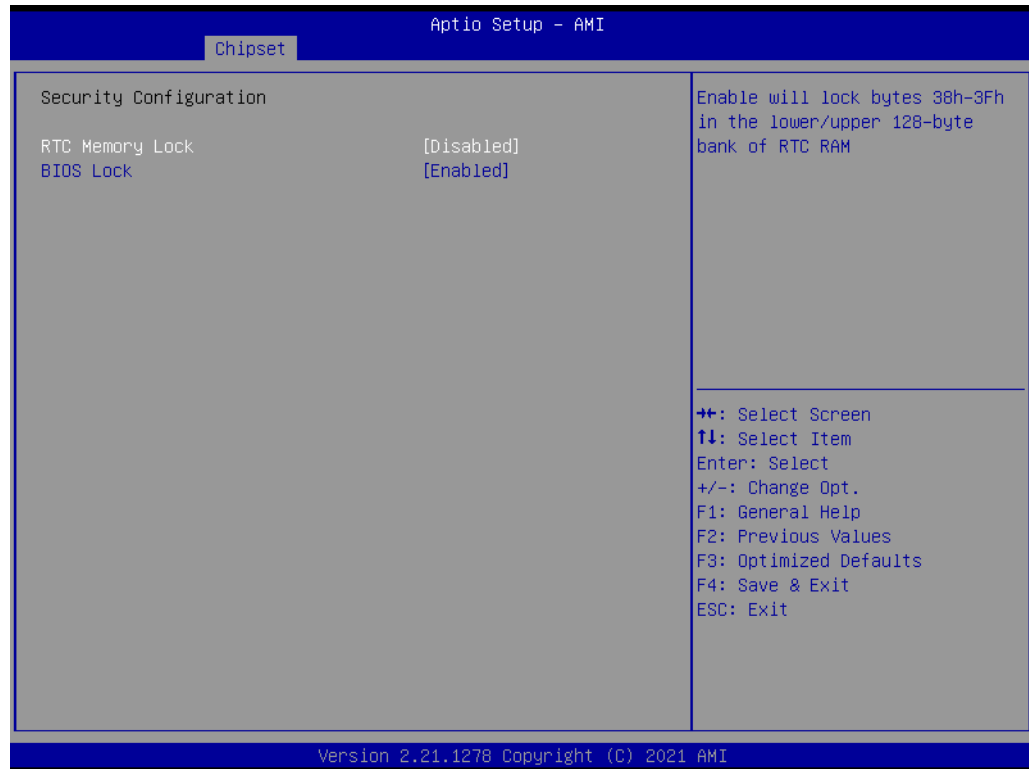

Figure 3.58 Security Configuration Settings

- **RTC Memory Lock**
- **BIOS Lock**

Serial I/O Configuration

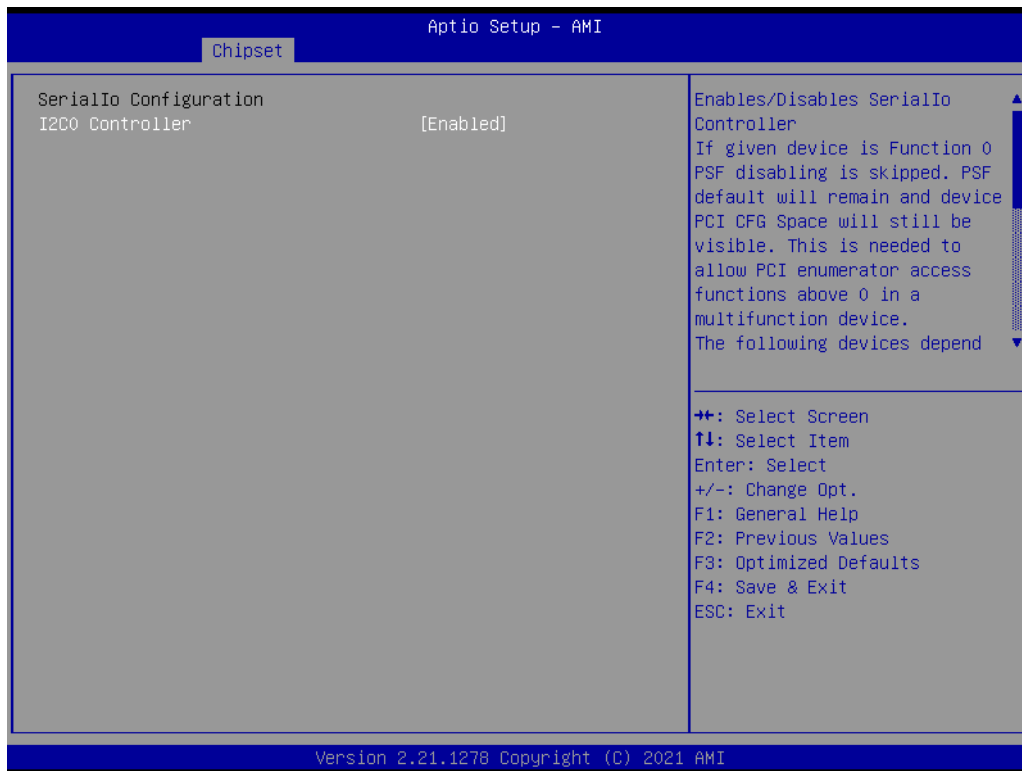

Figure 3.59 Serial I/O Configuration Settings

3.5.3 Security Settings

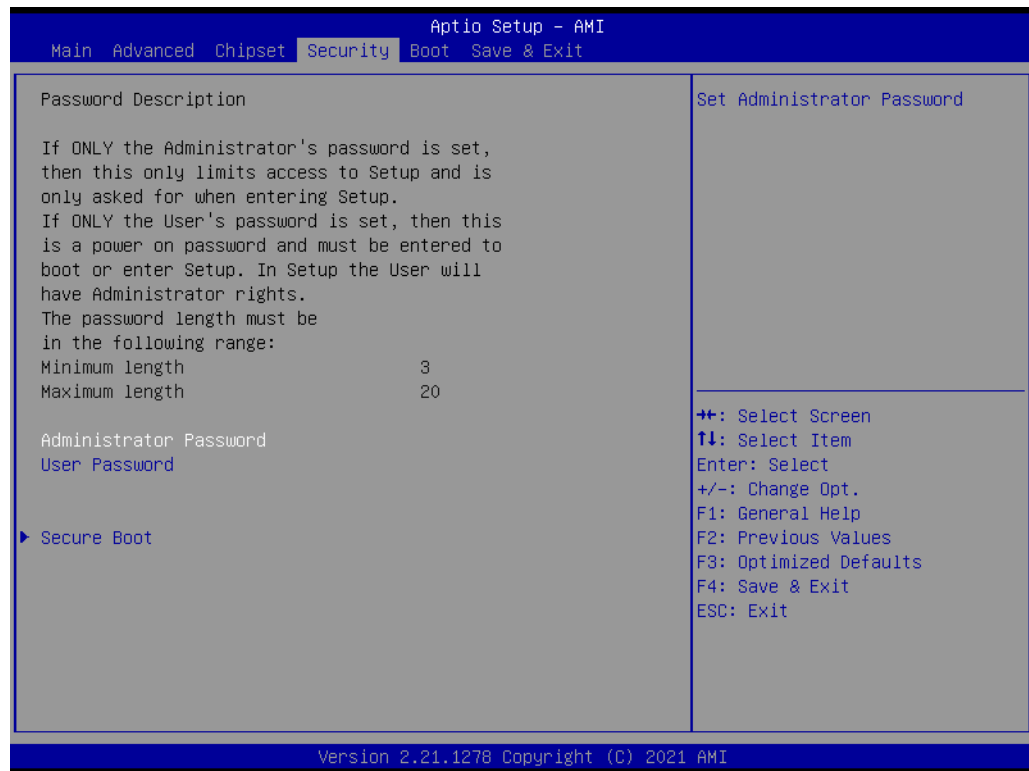

Figure 3.60 Security Setup

Select Security Setup from the SOM-6883 Setup main BIOS setup menu. All Security Setup options, such as password protection, are described in this section. To access the sub menu for the following items, select the item and press <Enter>:

Change Administrator/User Password: Select this option and press <ENTER> to access the sub menu, and then type in the password.

3.5.4 Boot Settings

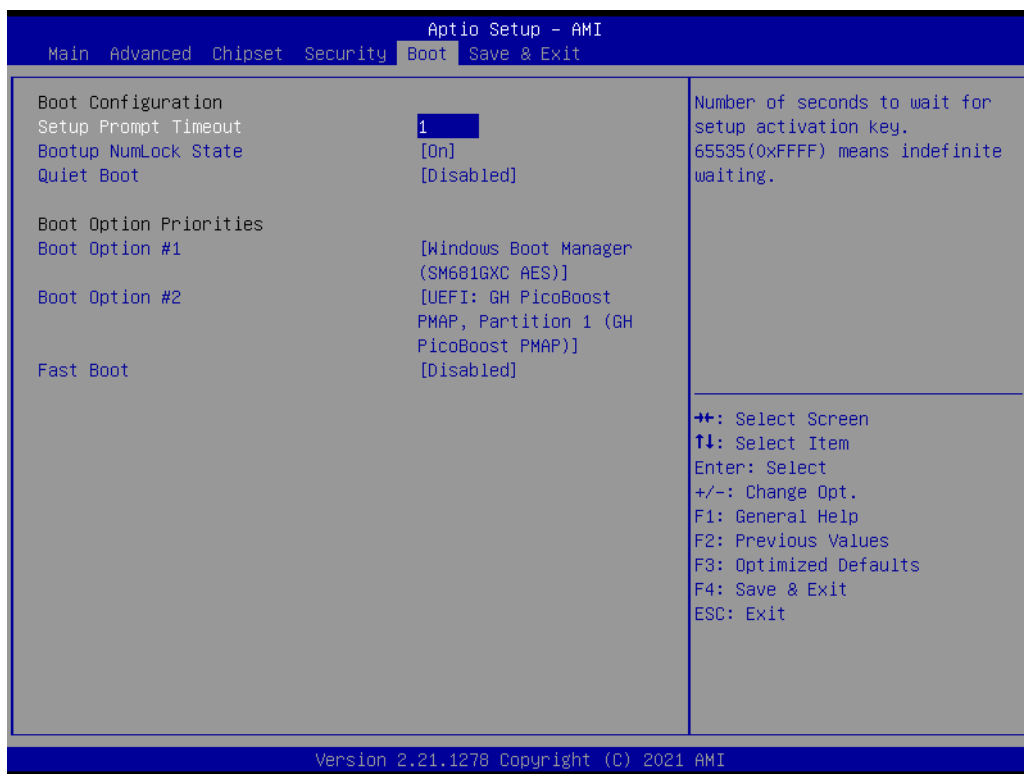

Figure 3.61 Security Setup

- Setup Prompt Timeout
- Bootup NumLock State
- Quiet Boot
- Boot option#1
- Fast Boot

3.5.5 Save & Exit

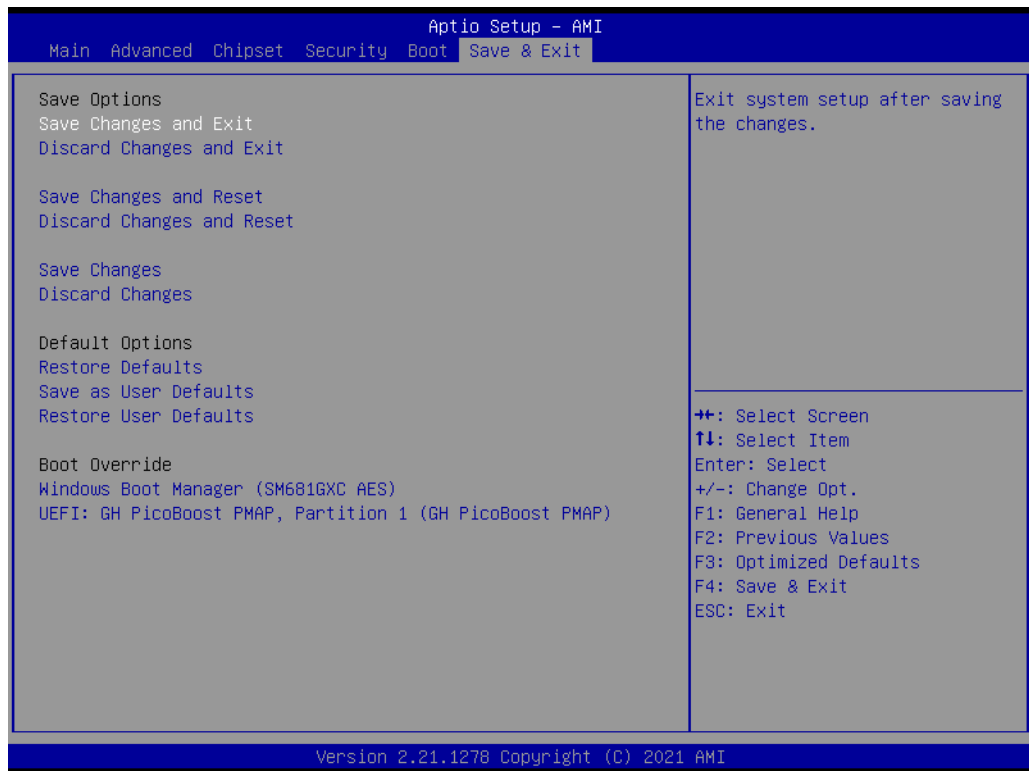

Figure 3.62 Security Setup

- **Save Changes and Exit**
- **Discard Changes and Exit**
- **Save Changes and Reset**
- **Discard Changes and Reset**
- **Save Changes**
- **Discard Changes**
- **Restore Defaults**
- **Save User Defaults**
- **Restore User Defaults**

Chapter 4

S/W Introduction and Installation

- S/W Introduction
- Driver Installation
- Advantech iManager

4.1 S/W Introduction

Advantech Embedded Software Services' mission is to "Enhance quality of life with Advantech platforms and Microsoft Windows embedded technology." We enable Windows Embedded software products on Advantech platforms to more effectively support the embedded computing community. Customers are freed from the hassle of dealing with multiple vendors (Hardware suppliers, System integrators, Embedded OS distributor) for projects. Our goal is to make Windows Embedded Software solutions easily and widely available to the embedded computing community.

4.2 Driver Installation

The Intel Chipset Software Installation (CSI) utility installs the Windows INF files that outline how the operating system and chipset components will be configured.

4.2.1 Windows Driver Setup

SOM-6883 supports Windows* 10 Enterprise. To install the drivers on a windows-based operation system, please connect to internet and browse the website <http://support.advantech.com.tw> and download the drivers that you want to install and follow Driver Setup instructions to complete the installation.

4.2.2 Other OS

SOM-6883 supports Linux:

Ubuntu (by Request)

Wind River VxWorks* 7.0(by Request)

4.3 Advantech iManager

Advantech's platforms come equipped with iManager, a micro controller that provides embedded features for system integrators. Embedded features have been moved from the OS/BIOS level to the board level to increase reliability and simplify integration.

iManager runs whether the operating system is running or not; it can count the boot times and running hours of the device, monitor device health, and provide an advanced watchdog to handle errors. iManager also comes with a secure and encrypted EEPROM for storing important security keys or other customer defined information. All the embedded functions are configured through API and provide corresponding utilities. These APIs comply with PICMG EAPI (Embedded Application Programmable Interface) specifications and unify in the same structures. This makes these embedded features easier to integrate, speed up development, and provide software continuity during hardware upgrade. Please refer to Advantech iManager 2.0 Software API User Manual for more details.

Control



GPIO

General Purpose Input/Output is a flexible parallel interface that allows a variety of custom connections. It allows users to monitor the level of signal input or set the output status to switch on/off a device. Our API also provides Programmable GPIO, which allows developers to dynamically set the GPIO input or output status.



SMBus

SMBus is the System Management Bus defined by Intel® Corporation in 1995. It is used in personal computers and servers for low-speed system management communications. The SMBus API allows a developer to interface a embedded system environment and transfer serial messages using the SMBus protocols, allowing multiple simultaneous device control.



I2C

I2C is a bi-directional two wire bus that was developed by Philips for use in their televisions in the 1980s. The I2C API allows a developer to interface with an embedded system environment and transfer serial messages using the I2C protocols, allowing multiple simultaneous device control.

Display



Brightness Control

The Brightness Control API allows a developer to interface with an embedded device to easily control brightness.



Backlight

The Backlight API allows a developer to control the backlight (screen) on/off in an embedded device.

Monitor



Watchdog

A watchdog timer (WDT) is a device that performs a specific operation after a certain period of time if something goes wrong and the system does not recover on its own. A watchdog timer can be programmed to perform a warm boot (restarting the system) after a certain number of seconds.



Hardware Monitor

The Hardware Monitor (HWM) API is a system health supervision API that inspects certain condition indexes, such as fan speed, temperature and voltage.



Hardware Control

The Hardware Control API allows developers to set the PWM (Pulse Width Modulation) value to adjust fan speed or other devices; it can also be used to adjust the LCD brightness.

Power Saving



CPU Speed

Make use of Intel SpeedStep technology to reduce power power consumption. The system will automatically adjust the CPU Speed depending on system loading.



System Throttling

Refers to a series of methods for reducing power consumption in computers by lowering the clock frequency. These APIs allow the user to lower the clock from 87.5% to 12.5%.

Appendix **A**

Pin Assignment

This appendix details the SOM-6883 hardware pin assignment

Sections include:

- SOM-6883 Type 6 Pin Assignment

A.1 SOM-6883 Type 6 Pin Assignment

This section surveys SOM-6883's pin assignment on COM Express connector. It is compliant with COMR.0 R3.0 Type 6 pin-out definitions. Contact Advantech to acquire further pin usage details or a design reference. Likewise, please contact Advantech for a design guide, checklist, reference schematic, and other hardware/software support.

SOM-6883 Row A, B			
A1	GND (FIXED)	B1	GND (FIXED)
A2	GBE0_MDI3-	B2	GBE0_ACT#
A3	GBE0_MDI3+	B3	LPC_FRAME#
A4	GBE0_LINK100#	B4	LPC_AD0
A5	GBE0_LINK1000#	B5	LPC_AD1
A6	GBE0_MDI2-	B6	LPC_AD2
A7	GBE0_MDI2+	B7	LPC_AD3
A8	GBE0_LINK#	B8	N/A
A9	GBE0_MDI1-	B9	N/A
A10	GBE0_MDI1+	B10	LPC_CLK
A11	GND (FIXED)	B11	GND (FIXED)
A12	GBE0_MDI0-	B12	PWRBTN#
A13	GBE0_MDI0+	B13	SMB_CK
A14	N/A	B14	SMB_DAT
A15	SUS_S3#	B15	SMB_ALERT#
A16	SATA0_TX+	B16	SATA1_TX+
A17	SATA0_TX-	B17	SATA1_TX-
A18	SUS_S4#	B18	SUS_STAT#
A19	SATA0_RX+	B19	SATA1_RX+
A20	SATA0_RX-	B20	SATA1_RX-
A21	GND (FIXED)	B21	GND (FIXED)
A22	SATA2_TX+	B22	N/A
A23	SATA2_TX-	B23	N/A
A24	SUS_S5#	B24	PWR_OK
A25	SATA2_RX+	B25	N/A
A26	SATA2_RX-	B26	N/A
A27	BATLOW#	B27	WDT
A28	(S)ATA_ACT#	B28	N/A
A29	HDA_SYNC	B29	HDA_SDIN1
A30	HDA_RST#	B30	HDA_SDIN0
A31	GND (FIXED)	B31	GND (FIXED)
A32	HDA_BITCLK	B32	SPKR
A33	HDA_SDOUT	B33	I2C_CK
A34	BIOS_DIS0#	B34	I2C_DAT
A35	THRMTRIP#	B35	THRM#
A36	USB6-	B36	USB7-
A37	USB6+	B37	USB7+
A38	USB_6_7_OC#	B38	USB_4_5_OC#
A39	USB4-	B39	USB5-
A40	USB4+	B40	USB5+

A41	GND (FIXED)	B41	GND (FIXED)
A42	USB2-	B42	USB3-
A43	USB2+	B43	USB3+
A44	USB_2_3_OC#	B44	USB_0_1_OC#
A45	USB0-	B45	USB1-
A46	USB0+	B46	USB1+
A47	VCC_RTC	B47	N/A
A48	RSVD	B48	USB_HOST_PRSNT
A49	N/A	B49	SYS_RESET#
A50	LPC_SERIRQ	B50	CB_RESET#
A51	GND (FIXED)	B51	GND (FIXED)
A52	PCIE_TX5+	B52	PCIE_RX5+
A53	PCIE_TX5-	B53	PCIE_RX5-
A54	GPI0	B54	GPO1
A55	PCIE_TX4+	B55	PCIE_RX4+
A56	PCIE_TX4-	B56	PCIE_RX4-
A57	GND	B57	GPO2
A58	PCIE_TX3+	B58	PCIE_RX3+
A59	PCIE_TX3-	B59	PCIE_RX3-
A60	GND (FIXED)	B60	GND (FIXED)
A61	PCIE_TX2+	B61	PCIE_RX2+
A62	PCIE_TX2-	B62	PCIE_RX2-
A63	GPI1	B63	GPO3
A64	PCIE_TX1+	B64	PCIE_RX1+
A65	PCIE_TX1-	B65	PCIE_RX1-
A66	GND	B66	WAKE0#
A67	GPI2	B67	WAKE1#
A68	PCIE_TX0+	B68	PCIE_RX0+
A69	PCIE_TX0-	B69	PCIE_RX0-
A70	GND (FIXED)	B70	GND (FIXED)
A71	LVDS_A0+	B71	LVDS_B0+
A72	LVDS_A0-	B72	LVDS_B0-
A73	LVDS_A1+	B73	LVDS_B1+
A74	LVDS_A1-	B74	LVDS_B1-
A75	LVDS_A2+	B75	LVDS_B2+
A76	LVDS_A2-	B76	LVDS_B2-
A77	LVDS_VDD_EN	B77	LVDS_B3+
A78	LVDS_A3+	B78	LVDS_B3-
A79	LVDS_A3-	B79	LVDS_BKLT_EN
A80	GND (FIXED)	B80	GND (FIXED)
A81	LVDS_A_CK+	B81	LVDS_B_CK+
A82	LVDS_A_CK-	B82	LVDS_B_CK-
A83	LVDS_I2C_CK	B83	LVDS_BKLT_CTRL
A84	LVDS_I2C_DAT	B84	VCC_5V_SBY
A85	GPI3	B85	VCC_5V_SBY
A86	N/A (*Note)	B86	VCC_5V_SBY
A87	eDP_HPD	B87	VCC_5V_SBY
A88	PCIE_CLK_REF+	B88	BIOS_DIS1#

A89	PCIE_CLK_REF-	B89	VGA_RED
A90	GND (FIXED)	B90	GND (FIXED)
A91	SPI_POWER	B91	VGA_GRN
A92	SPI_MISO	B92	VGA_BLU
A93	GPO0	B93	VGA_HSYNC
A94	SPI_CLK	B94	VGA_VSYNC
A95	SPI_MOSI	B95	VGA_I2C_CK
A96	TPM_PP	B96	VGA_I2C_DAT
A97	N/A	B97	SPI_CS#
A98	SER0_TX	B98	N/A
A99	SER0_RX	B99	N/A
A100	GND (FIXED)	B100	GND (FIXED)
A101	SER1_TX	B101	FAN_PWMOUT
A102	SER1_RX	B102	FAN_TACHIN
A103	LID#	B103	SLEEP#
A104	VCC_12V	B104	VCC_12V
A105	VCC_12V	B105	VCC_12V
A106	VCC_12V	B106	VCC_12V
A107	VCC_12V	B107	VCC_12V
A108	VCC_12V	B108	VCC_12V
A109	VCC_12V	B109	VCC_12V
A110	GND (FIXED)	B110	GND (FIXED)

SOM-6883 Row C, D

C1	GND (FIXED)	D1	GND (FIXED)
C2	GND	D2	GND
C3	USB_SSRX0-	D3	USB_SSTX0-
C4	USB_SSRX0+	D4	USB_SSTX0+
C5	GND	D5	GND
C6	USB_SSRX1-	D6	USB_SSTX1-
C7	USB_SSRX1+	D7	USB_SSTX1+
C8	GND	D8	GND
C9	USB_SSRX2-	D9	USB_SSTX2-
C10	USB_SSRX2+	D10	USB_SSTX2+
C11	GND (FIXED)	D11	GND (FIXED)
C12	USB_SSRX3-	D12	USB_SSTX3-
C13	USB_SSRX3+	D13	USB_SSTX3+
C14	GND	D14	GND
C15	N/A	D15	DDI1_CTRLCLK_AUX+
C16	N/A	D16	DDI1_CTRLDATA_AUX-
C17	N/A	D17	N/A
C18	N/A	D18	N/A
C19	PCIE_RX6+	D19	PCIE_TX6+
C20	PCIE_RX6-	D20	PCIE_TX6-
C21	GND (FIXED)	D21	GND (FIXED)
C22	PCIE_RX7+	D22	PCIE_TX7+
C23	PCIE_RX7-	D23	PCIE_TX7-
C24	DDI1_HPD	D24	N/A
C25	N/A	D25	N/A

C26	N/A	D26	DDI1_PAIR0+
C27	N/A	D27	DDI1_PAIR0-
C28	N/A	D28	N/A
C29	N/A	D29	DDI1_PAIR1+
C30	N/A	D30	DDI1_PAIR1-
C31	GND (FIXED)	D31	GND (FIXED)
C32	DDI2_CTRLCLK_AUX+	D32	DDI1_PAIR2+
C33	DDI2_CTRLDATA_AUX-	D33	DDI1_PAIR2-
C34	DDI2_DDC_AUX_SEL	D34	DDI1_DDC_AUX_SEL
C35	N/A	D35	N/A
C36	N/A	D36	DDI1_PAIR3+
C37	N/A	D37	DDI1_PAIR3-
C38	N/A	D38	N/A
C39	N/A	D39	DDI2_PAIR0+
C40	N/A	D40	DDI2_PAIR0-
C41	GND (FIXED)	D41	GND (FIXED)
C42	N/A	D42	DDI2_PAIR1+
C43	N/A	D43	DDI2_PAIR1-
C44	N/A	D44	DDI2_HPD
C45	N/A	D45	N/A
C46	N/A	D46	DDI2_PAIR2+
C47	N/A	D47	DDI2_PAIR2-
C48	N/A	D48	N/A
C49	N/A	D49	DDI2_PAIR3+
C50	N/A	D50	DDI2_PAIR3-
C51	GND (FIXED)	D51	GND (FIXED)
C52	N/A	D52	N/A
C53	N/A	D53	N/A
C54	N/A	D54	N/A
C55	N/A	D55	N/A
C56	N/A	D56	N/A
C57	N/A	D57	TYPE2# (GND)
C58	N/A	D58	N/A
C59	N/A	D59	N/A
C60	GND (FIXED)	D60	GND (FIXED)
C61	N/A	D61	N/A
C62	N/A	D62	N/A
C63	N/A	D63	N/A
C64	N/A	D64	N/A
C65	N/A	D65	N/A
C66	N/A	D66	N/A
C67	RAPID_SHUTDOWN	D67	GND
C68	N/A	D68	N/A
C69	N/A	D69	N/A
C70	GND (FIXED)	D70	GND (FIXED)
C71	N/A	D71	N/A
C72	N/A	D72	N/A
C73	GND	D73	GND

C74	N/A	D74	N/A
C75	N/A	D75	N/A
C76	GND	D76	GND
C77	N/A	D77	N/A
C78	N/A	D78	N/A
C79	N/A	D79	N/A
C80	GND (FIXED)	D80	GND (FIXED)
C81	N/A	D81	N/A
C82	N/A	D82	N/A
C83	N/A	D83	N/A
C84	GND	D84	GND
C85	N/A	D85	N/A
C86	N/A	D86	N/A
C87	GND	D87	GND
C88	N/A	D88	N/A
C89	N/A	D89	N/A
C90	GND (FIXED)	D90	GND (FIXED)
C91	N/A	D91	N/A
C92	N/A	D92	N/A
C93	GND	D93	GND
C94	N/A	D94	N/A
C95	N/A	D95	N/A
C96	GND	D96	GND
C97	N/A	D97	RSVD
C98	N/A	D98	N/A
C99	N/A	D99	N/A
C100	GND (FIXED)	D100	GND (FIXED)
C101	N/A	D101	N/A
C102	N/A	D102	N/A
C103	GND	D103	GND
C104	VCC_12V	D104	VCC_12V
C105	VCC_12V	D105	VCC_12V
C106	VCC_12V	D106	VCC_12V
C107	VCC_12V	D107	VCC_12V
C108	VCC_12V	D108	VCC_12V
C109	VCC_12V	D109	VCC_12V
C110	GND (FIXED)	D110	GND (FIXED)

*Note: A86 could be an optional pin reserved for SD_PWR_EN. Please contact FAE for details.

Appendix **B**

Watchdog Timer

This appendix details watchdog timer programming information for the SOM-6883 CPU System on Module.

Sections include:

- Watchdog Timer Programming

B.1 Programming the Watchdog Timer

Trigger Event	Note
IRQ	(BIOS setting default disable)**
NMI	N/A
SCI	Support
Power Off	Support
H/W Restart	Support
WDT Pin Activate	Support

** WDT new driver support automatically selects available IRQ numbers from BIOS, and then sets the EC. This is only supported in Windows 10.

Other OS use IRQ numbers from the BIOS settings.

For details, please refer to the iManager & Software API User Manual.

Appendix **C**

Programming GPIO

This appendix diagrams General Purpose Input and Output pin settings.

Sections include:

- System I/O ports

C.1 GPIO Register

GPIO Byte Mapping	H/W Pin Name
BIT0	GPI 0
BIT1	GPI 1
BIT2	GPI 2
BIT3	GPI 3
BIT4	GPO 0
BIT5	GPO 1
BIT6	GPO 2
BIT7	GPO 3

For details, please refer to iManager & Software API User Manual.

Appendix **D**

System Assignments

This appendix details the SOM-6883 system resource allocation.

Sections include:

- System I/O ports
- DMA Channel Assignments
- Interrupt Assignments
- 1st MB Memory Map

D.1 System I/O Ports

Table D.1: System I/O ports

Addr.Range(Hex)	Device
0299-029A	Motherboard resources
02C0-02DF	Motherboard resources
02A0-02BF	Motherboard resources
0290-02AD	Motherboard resources
0060-006F	Motherboard resources
0200-027F	Motherboard resources
0300-037F	Motherboard resources
0280-028F	Motherboard resources
02F0-02F7	Motherboard resources
002E-002F	Motherboard resources
004E-004F	Motherboard resources
0061-0061	Motherboard resources
0063-0063	Motherboard resources
0065-0065	Motherboard resources
0067-0067	Motherboard resources
0070-0070	Motherboard resources
0080-0080	Motherboard resources
0092-0092	Motherboard resources
00B2-00B3	Motherboard resources
0680-069F	Motherboard resources
164E-164F	Motherboard resources
0062-0062	Microsoft ACPI-Compliant Embedded Controller
0066-0066	Microsoft ACPI-Compliant Embedded Controller
0020-0021	Programmable interrupt controller
0024-0025	Programmable interrupt controller
0028-0029	Programmable interrupt controller
002C-002D	Programmable interrupt controller
0030-0031	Programmable interrupt controller
0034-0035	Programmable interrupt controller
0038-0039	Programmable interrupt controller
003C-003D	Programmable interrupt controller
00A0-00A1	Programmable interrupt controller
00A4-00A5	Programmable interrupt controller
00A8-00A9	Programmable interrupt controller
00AC-00AD	Programmable interrupt controller
00B0-00B1	Programmable interrupt controller
00B4-00B5	Programmable interrupt controller
00B8-00B9	Programmable interrupt controller
00BC-00BD	Programmable interrupt controller
04D0-04D1	Programmable interrupt controller
1854-1857	Motherboard resources
3090-3097	Standard SATA AHCI Controller
3080-3083	Standard SATA AHCI Controller

Table D.1: System I/O ports

3060-307F	Standard SATA AHCI Controller
03F8-03FF	Communications Port (COM1)
02F8-02FF	Communications Port (COM2)
1800-18FE	Motherboard resources
0000-0CF7	PCI Express Root Complex
0D00-FFFF	PCI Express Root Complex
FFF8-FFFF	Intel® Active Management Technology - SOL (COM3)
0040-0043	System timer
0050-0053	System timer
2000-20FE	Motherboard resources
3000-303F	Intel® Iris® Xe Graphics
EFA0-EFBF	Intel® SMBus - A0A3

D.2 Interrupt Assignments

Table D.2: Interrupt Assignments

Interrupt#	Interrupt Source
IRQ 0	System Timer
IRQ 3	Communications Port (COM2)
IRQ 4	Communications Port (COM1)
IRQ 6	Motherboard resources
IRQ 14	Intel® GPIO Controller - 34C5
IRQ 16	High Definition Audio Controller
IRQ 19	Intel® Active Management Technology - SOL (COM3)
IRQ 28	Trusted Platform Module 2.0
IRQ54-511	Microsoft ACPI-Compliant System
IRQ 4294967292	Standard SATA AHCI Controller
IRQ 4294967275(-9)	Intel® Ethernet Controller (3) I225-LM
IRQ 4294967293	Intel® PCI Express Root Port #9 - A0B0
IRQ 4294967283(-91)	Standard NVM Express Controller
IRQ 4294967273	Intel® Management Engine Interface
IRQ 4294967280	Intel® Iris® Xe Graphics
IRQ 4294967294	PCI Express Root Port
IRQ 4294967274	Intel® GNA Scoring Accelerator module

D.3 1st MB Memory Map

Table D.3: 1st MB Memory Map

Addr. Range (Hex)	Device
0xFEDC0000-0xFEDC7FFF	Motherboard resources
0xFEDA0000-0xFEDA0FFF	Motherboard resources
0xFEDA1000-0xFEDA1FFF	Motherboard resources
0xC0000000-0xCFFFFFFF	Motherboard resources
0xFED20000-0xFED7FFFF	Motherboard resources

Table D.3: 1st MB Memory Map

0xFED90000-0xFED93FFF	Motherboard resources
0xFED45000-0xFED8FFFF	Motherboard resources
0xFEE00000-0xFEEFFFFFFF	Motherboard resources
0x50700000-0x50701FFF	Standard SATA AHCI Controller
0x50703000-0x507030FF	Standard SATA AHCI Controller
0x50702000-0x507027FF	Standard SATA AHCI Controller
0xFED00000-0xFED003FF	High precision event timer
0x50500000-0x505FFFFFFF	Intel® Ethernet Controller (3) I225-LM
0x504FC000-0x504FFFFFFF	Intel® Ethernet Controller (3) I225-LM
0xFE000000-0xFE01FFFF	Motherboard resources
0xFE04C000-0xFE04FFFF	Motherboard resources
0xFE050000-0xFE0AFFFF	Motherboard resources
0xFE0D0000-0xFE0FFFFFFF	Motherboard resources
0xFE200000-0xFE7FFFFFFF	Motherboard resources
0xFF000000-0xFFFFFFFF	Motherboard resources
0xFD000000-0xFD68FFFF	Motherboard resources
0xFD6B0000-0xFD6CFFFF	Motherboard resources
0xFD6F0000-0xFDFFFFFFF	Motherboard resources
0x50400000-0x505FFFFFFF	Intel® PCI Express Root Port #9 - A0B0
0x50600000-0x50603FFF	Standard NVM Express Controller
0xA0000-0xBFFFF	PCI Express Root Complex
0xE0000-0xE3FFF	PCI Express Root Complex
0xE4000-0xE7FFF	PCI Express Root Complex
0xE8000-0xEBFFF	PCI Express Root Complex
0xEC000-0xEFFFF	PCI Express Root Complex
0xF0000-0xFFFFF	PCI Express Root Complex
0xFE010000-0xFE010FFF	Intel® SPI (flash) Controller - A0A4
0xBFFFF000-0xBFFFFFFF	Intel® Active Management Technology - SOL (COM3)
0xFD6E0000-0xFD6EFFFF	Intel® GPIO Controller - 34C5
0xFD6D0000-0xFD6DFFFF	Intel® GPIO Controller - 34C5
0xFD6A0000-0xFD6AFFFF	Intel® GPIO Controller - 34C5
0xFD690000-0xFD69FFFF	Intel® GPIO Controller - 34C5
0xFED40000-0xFED44FFF	Trusted Platform Module 2.0
0xFFEFA000-0xFFEFAFFF	Intel® Management Engine Interface
0x0000-0xFFFFFFFF	Intel® Iris® Xe Graphics
0x0000-0xFFFFFFFF	Intel® Iris® Xe Graphics
0xFFEFB000-0xFFEFBFFF	Intel® GNA Scoring Accelerator module
0xFFEFC000-0xFFEFFFFFFF	High Definition Audio Controller
0xFFFF0000-0xFFFFFFFF	High Definition Audio Controller
0x1128000-0x11280FF	Intel® SMBus - A0A3

ADVANTECH

Enabling an Intelligent Planet

www.advantech.com

Please verify specifications before quoting. This guide is intended for reference purposes only.

All product specifications are subject to change without notice.

No part of this publication may be reproduced in any form or by any means, electronic, photocopying, recording or otherwise, without prior written permission from the publisher.

All brand and product names are trademarks or registered trademarks of their respective companies.

© Advantech Co., Ltd. 2021