

## MIO-5272

**3.5" MI/O-Compact Single Board  
Computer with Fanless Gen 6/7  
Intel® Core™ U-series (i7/i5/ i3/  
Celeron®\*) Processor, DDR3L, VGA,  
HDMI, LVDS (48 bit), 2 x GbE, 2 x  
Mini PCIe, mSATA, and MIOe**

---

## Copyright

The documentation and the software included with this product are copyrighted 2019 by Advantech Co., Ltd. All rights are reserved. Advantech Co., Ltd. reserves the right to make improvements in the products described in this manual at any time without notice. No part of this manual may be reproduced, copied, translated or transmitted in any form or by any means without the prior written permission of Advantech Co., Ltd. The information provided in this manual is intended to be accurate and reliable. However, Advantech Co., Ltd. assumes no responsibility for its use, nor for any infringements of the rights of third parties that may result from its use.

## Acknowledgements

Intel® is a trademark of Intel® Corporation.

AMI is a trademark of American Megatrends, Inc.

IBM, PC, PS/2 and VGA are trademarks of International Business Machines Corporation.

Microsoft Windows®, DirectX® is a registered trademark of Microsoft Corp.

All other product names or trademarks are properties of their respective owners.

For more information about this or other Advantech products, visit the Advantech website at

<http://www.advantech.com>

or

<http://www.advantech.com/eplatform>

For technical support and customer service, visit the Advantech support website at

<http://support.advantech.com/>

This manual is for MIO-5272.

## Product Warranty (2 years)

Advantech warrants to you, the original purchaser, that each of its products will be free from defects in materials and workmanship for two years from the date of purchase.

This warranty does not apply to any products which have been repaired or altered by persons other than repair personnel authorized by Advantech, or which have been subject to misuse, abuse, accident or improper installation. Advantech assumes no liability under the terms of this warranty as a consequence of such events.

Because of Advantech's high quality-control standards and rigorous testing, most of our customers never need to use our repair service. If an Advantech product is defective, it will be repaired or replaced at no charge during the warranty period. For out-of-warranty repairs, you will be billed according to the cost of replacement materials, service time and freight. Please consult your dealer for more details.

If you think you have a defective product, follow these steps:

1. Collect all the information about the problem encountered. (For example, CPU speed, Advantech products used, other hardware and software used, etc.) Note anything abnormal and list any onscreen messages you get when the problem occurs.
2. Call your dealer and describe the problem. Please have your manual, product, and any helpful information readily available.
3. If your product is diagnosed as defective, obtain an RMA (return merchandise authorization) number from your dealer. This allows us to process your return more quickly.
4. Carefully pack the defective product, a fully-completed Repair and Replacement Order Card and a photocopy proof of purchase date (such as your sales receipt) in a shippable container. A product returned without proof of the purchase date is not eligible for warranty service.
5. Write the RMA number visibly on the outside of the package and ship it prepaid to your dealer.

---

# Declaration of Conformity

## CE

This product has passed the CE test for environmental specifications. Test conditions for passing included the equipment being operated within an industrial enclosure. In order to protect the product from being damaged by electrostatic discharge (ESD) and electromagnetic interference (EMI) leakage, we strongly recommend the use of CE-compliant industrial enclosure products.

## FCC Class A

This equipment has been tested and found to comply with the limits for a Class A digital device, pursuant to part 15 of the FCC Rules. These limits are designed to provide reasonable protection against harmful interference when the equipment is operated in a commercial environment. This equipment generates, uses, and can radiate radio frequency energy and, if not installed and used in accordance with the instruction manual, may cause harmful interference to radio communications. Operation of this equipment in a residential area is likely to cause harmful interference in which case the user will be required to correct the interference at his/her own expense.

**Caution!** *There is a danger of a new battery exploding if it is incorrectly installed. Do not attempt to recharge, force open, or heat the battery. Replace the battery only with the same or equivalent type recommended by the manufacturer. Discard used batteries according to the manufacturer's instructions.*



## Technical Support and Assistance

1. Visit the Advantech website at <http://support.advantech.com> to obtain the latest product information.
2. Contact your distributor, sales representative, or Advantech's customer service center for technical support if you need additional assistance. Please have the following information ready before you call:
  - Product name and serial number
  - Description of your peripheral attachments
  - Description of your software (operating system, version, application software, etc.)
  - A complete description of the problem
  - The exact wording of any error messages

## Packing List

Before installing the card, ensure that the following materials have been shipped:

- 1 x MIO-5272 SBC
- 1 x SATA cable 30 cm (p/n: 1700006291)
- 1 x SATA power cable 35 cm (p/n: 1700018785)
- 1 x Audio cable 20 cm (p/n: 1700019584)
- 1 x COM RS-232 cable 22 cm (p/n: 1701200220)
- 1 x Heatsink (24 mm) (p/n: 1960068763T001)
- 1 x Startup manual (p/n: 2006527200)
- 1 x Mini jumper (10-piece package) (p/n: 9689000002)
- 1 x Screw Kit (4 x screws for mini PCIe) (p/n: 9666525100E)
- 1 x SUSIAccess Pro package (p/n: 968EMLSAP1)

If any of these items are missing or damaged, contact your distributor or sales representative immediately.

## Optional MIOe Module

Part Number	Description
MIOe-210-D6A1E	4 x RS232/422/485 2x RS422/485 with DSUB connector, 8-bit GPIO
MIOe-220-B3A1E <sup>1</sup>	3 x Intel® Gigabit Ethernet with PCIe Switch
MIOe-230-L0A1E	Displayport to 48-bit LVDS
MIOe-DB5000-01A1E	MI/O extension evaluation board
MIOe-3674-AE <sup>2</sup>	4-port PoE ports MIOe Module
MIOe-3680-AE	2-Port CAN-Bus MIOe Module with Isolation Protection
MIOE-PWR1-00A1E	12-24V Power module
MIOE-PWR2-00A1E	9-36V Power module

<sup>1</sup> No USB support for MIOe-230

<sup>2</sup> Supported with customized BIOS

## Optional Accessories

Part Number	Description
1960074236N001	Heat spreader 145 x 84 x 16-mm MIO-5272
1935032000	Screw of Heatsink R/S 5.5 2.0 +M M3*20L ST Ni
1700002172	Internal 2-port USB cable 17 cm



# Contents

<b>Chapter 1</b>	<b>General Information .....</b>	<b>1</b>
1.1	Introduction .....	2
1.2	Specifications .....	2
1.2.1	Functional Specifications .....	2
1.2.2	OS Support .....	4
1.2.3	Mechanical Specifications .....	5
1.2.4	Electrical Specifications .....	5
1.2.5	Environmental .....	5
1.3	Block Diagram .....	6
1.4	Board Dimensions .....	6
	Figure 1.1 MIO-5272 Mechanical Drawing (Top Side) .....	6
	Figure 1.2 MIO-5272 Mechanical Drawing (Bottom Side) .....	7
	Figure 1.3 MIO-5272 Mechanical Drawing (Coastline) .....	7
	Figure 1.4 MIO-5272 Mechanical Drawing (with Heatsink) .....	8
	Figure 1.5 MIO-5272 Mechanical Drawing (with Heat Spreader) .....	8
<b>Chapter 2</b>	<b>Installation.....</b>	<b>9</b>
2.1	Jumpers & Switches.....	10
	Table 2.1: Jumpers & Switches .....	10
2.2	Connectors.....	10
	Table 2.2: Connectors .....	10
2.3	Connector Locations .....	11
	Figure 2.1 MIO-5272 Connector Locations (Top Side).....	11
	Figure 2.2 MIO-5272 Connector Locations (Bottom Side).....	11
	Figure 2.3 MIO-5272 Connector Locations (Coastline) .....	12
2.4	Setting Jumpers .....	12
2.4.1	Auto Power On Setting (J1) .....	12
	Table 2.3: Auto Power On Setting (J1).....	12
2.4.2	LCD Power (J2) .....	13
	Table 2.4: LCD Power (J2) .....	13
2.4.3	Clear CMOS (SW2) .....	13
	Table 2.5: Clear CMOS (SW2).....	13
<b>Chapter 3</b>	<b>AMI BIOS Setup .....</b>	<b>15</b>
	Figure 3.1 Setup Program Initial Screen .....	16
3.1	Entering Setup .....	17
3.2	Main Setup .....	17
	Figure 3.2 Main Setup Screen .....	17
3.2.1	Advanced BIOS Features Setup.....	18
	Figure 3.3 Advanced BIOS Features Setup Screen .....	18
	Figure 3.4 PCI Subsystem Settings.....	19
3.2.2	Chipset.....	32
	Figure 3.5 Chipset Setup .....	32
	Figure 3.6 System Agent (SA) Configuration.....	33
3.2.3	Security .....	43
	Figure 3.7 Password Configuration .....	43
3.2.4	Boot.....	44
	Figure 3.8 Boot .....	44
3.2.5	Save & Exit .....	45
	Figure 3.9 Save & Exit.....	45

<b>Chapter 4</b>	<b>MIOe Installation .....</b>	<b>47</b>
4.1	Quick Installation Guide .....	48
<b>Appendix A</b>	<b>Pin Assignments .....</b>	<b>51</b>
A.1	Jumper, Switch List, and Settings .....	52
<b>Appendix B</b>	<b>System Assignments.....</b>	<b>77</b>
B.1	System I/O Ports .....	78
	Table B.1: System I/O Ports .....	78
B.2	DMA Channel Assignments .....	78
	Table B.2: DMA Channel Assignments .....	78
B.3	First MB Memory Map.....	78
	Table B.3: First MB Memory Map .....	78
B.4	Interrupt Assignments .....	79
	Table B.4: Interrupt Assignments .....	79



# Chapter 1

## General Information

This chapter gives background information regarding MIO-5272.

- Introduction
- Specifications
- Block Diagram
- Board Layout and Dimensions

## 1.1 Introduction

MIO-5272 is designed using the MI/O Extension form factor (compact series, 146 x 102 mm) and powered by Gen 6/7 Intel® Core™ U series processors, which have low power features but also high performance computing and multimedia capabilities. Based on numerous demands from embedded applications, Advantech developed an optimized thermal solution for MIO-5272. This makes the possibility of fanless design on this kind of high performance platform. MIO-5272 also embeds SUSI 4.0 and WISE-PaaS/RMM created by Advantech to monitor and control system operation effectively and remotely. These tools offer greater system reliability and a smarter software framework for embedded customers and helps them speed up development times.

MIO-5272 adopts the latest 64-bit, multi-core processors built on 14nm process technology for improvements in CPU processing, graphics, security and I/O flexibility. Moreover, MIO-5272 is equipped with the latest generation graphics core (Intel® HD Graphics 520) with DirectX 11.3, OpenGL 4.4, OpenCL 2.1 and 4K encoding/decoding which increases more possibilities for multimedia application development. MIO-5272 supports not only triple independent displays including HDMI, VGA, and 48-bit LVDS interfaces, but also low power dual 8GB 1600MHz DDR3L memory and TPM, making it suitable for various high level embedded applications.

## 1.2 Specifications

### 1.2.1 Functional Specifications

- Processor: Generation 6/7 Intel® Core™ U-series
  - i7 7600U 2.8 GHz, dual-core, four threads
  - i7 6600U 2.6 GHz, dual-core, four threads
  - i5 6300U 2.4 GHz, dual-core, four threads
  - i3 6100U 2.3 GHz, dual-core, four threads
  - Celeron 3955U<sup>1</sup> 2.0 GHz, dual-core, two threads
- L3 Cache:
  - i7 7600U: 4MB
  - i7 6600U: 4MB
  - i5 6300U: 3MB
  - i3 6100U: 3MB
  - Celeron 3955U: 2MB
- Advanced Technologies
  - \* Intel® Turbo Boost Technology 2.0<sup>2</sup> (i5/i7 series only)
  - \* Intel® Advanced Vector Extensions 2.0 (Intel® AVX2)
  - \* Intel® Hyper-Threading Technology
  - \* Intel® Active Management Technology 11.0 (Intel® AMT 11.0, i5/i7 series only)
  - \* Intel® Trusted Execution Technology (Intel® TXT)
  - \* Intel® 64 Architecture
  - \* Intel® Virtualization Technology (Intel® VT)
  - \* Intel® Advanced Encryption Standard New Instructions (Intel® AES-NI)
  - \* Enhanced Intel SpeedStep® Technology

- **I/O interface of Platform Controller Hub**
  - Integrated Serial ATA Host Controller
    - \* Data transfer rates up to 6.0 Gb/s (600 MB/s)
    - \* Integrated AHCI controller
  - USB
    - \* xHCI Host Controller, supporting 2 SuperSpeed USB 3.0 ports
    - \* One EHCI Host Controllers, supporting 2 HighSpeed USB 2.0 ports
    - \* Supports wake-up from sleeping states S1, S3
    - \* Supports legacy Keyboard/Mouse software
  - Power Management
    - \* Full support of ACPI C-states as implemented by the following processor C-states: — C0, C1, C1E, C3, C6, C7, C8, C9, C10
    - \* Enhanced Intel SpeedStep® Technology
- **System Memory Support**
  - Non-ECC, DDR3L/DDR3L-RS and LPDDR3 memory with dual SO-DIMM up to 16GB
  - DDR3L/DDR3L-RS I/O Voltage of 1.35V
    - \* 1333 MT/s (PC3-10600), 1600 MT/s (PC3-12800)
  - 64-bit wide channels
  - Intel® Fast Memory Access (Intel® FMA):
    - \* Just-in-Time Command Scheduling
    - \* Command Overlap
    - \* Out-of-Order Scheduling
- **Integrated Graphics Controller**
  - Contains a generation 9 graphics core architecture (Intel® HD Graphics 620/520/510 (Celeron))
  - Intel® QuickSync & Clear Video Technology HD Support
  - Full Hardware Accelerated Video Decode: AVC/VC1/MPEG2/HEVC/VP8/JPEG.
  - OpenGL4.4 and OpenCL2.1 support
  - DirectX 12, DirectX 11.3, DirectX 11.2, DirectX 11.1, DirectX 10, DirectX 9 support
  - Multi-display interfaces: VGA, HDMI on rear I/O, Dual Channel 24-bit LVDS, DisplayPort<sup>1</sup> from MIOe
  - Support Extend, Clone and Collage mode with multi-display device
  - Dual Display:
    - \* Any two combination between: VGA, LVDS, HDMI (from Rear I/O line)
  - Triple Display:
    - \* VGA+HDMI+ LVDS
  - Integrated Dual-channel LVDS support resolution up to 1920x1200 at 60 Hz
  - Analog RGB display (VGA) output up to resolution 1920 x 1200 with 60 Hz, or 2048 x 1152 @ 60Hz with reduced blanking.
  - HDMI interface supports the HDMI 1.4a specification with audio up to 4096x2160 at 24 Hz (Supporting 4K display required two DDR channels of same size).

- **Gigabit Ethernet**
  - Port 1: Integrated Intel 100 Series Chipset (MAC) + i219 GbE (PHY)
    - \* Integrated ASF Management Controller
    - \* 10/100/1000 BASE-T IEEE 802.3 specification conformance
    - \* Supports the Energy Efficient Ethernet (EEE) IEEE802.3az specification
    - \* Supports up to 9 KB jumbo frames (full duplex)
    - \* 802.1as/1588 conformance
  - Port 2: i210 Gigabit Ethernet Controller
    - \* Flow Control Support compliant with the 802.3X Specification
    - \* Compliant with the 1 Gb/s IEEE 802.3 802.3u 802.3ab Specifications
    - \* Magic Packet\* wake-up enabled with unique MAC address
    - \* Supports IEEE 1588
- **Peripheral Interface**
  - MIOe Unified Expansion
    - \* DisplayPort<sup>1</sup>
    - \* 2 PCIe x1
    - \* USB 3.0
    - \* LPC
    - \* HD Audio: Line out
    - \* SMBus
    - \* Power: +5 Vsb/+12 Vsb, Power On, Reset
  - 2 Serial-ATA port, up to 6.0 Gb/s (600 MB/s)
  - 2 USB 3.0 and 2 USB2.0 compliant ports on rear I/O, 2 USB2.0 compliant ports for internal connection<sup>1</sup>
  - 2 RS-232/422/485 (ESD protection: Air gap ±15kV, Contact ±8kV)
  - 8-bit Programmable General Purpose Input/ Output from iManager
  - 1 SMBus / I<sup>2</sup>C channel from iManager
  - Watchdog timer: Output System Reset, Programmable counter from 1 ~ 255 minutes/ seconds
  - Mini PCIe / mSATA
    - \* 1 Full-size mSATA/ Mini PCIe (default supports mSATA) (One Mini PCIe default supports mSATA, can be selected in BIOS)
    - \* 1 Half-size Mini PCIe with SIM card holder
- **High Definition Audio:**
  - Intel<sup>®</sup> High Definition Audio Interface
  - High Definition Audio Codec with Realtek proprietary loss-less content protection technology
  - Supports 1 x Line-input, 1 x Line output, 1 x Mic-input
- **BIOS**
  - AMI UEFI 128 Mbit
- **Security:**
  - TPM2.0\*, only support under UEFI mode

## 1.2.2 OS Support

MIO-5272 supports Win 10, Win7, WES7

For further information about OS support of MIO-5272, please Advantech website or contact the technical support center.

<http://support.advantech.com.tw/>

### 1.2.3 Mechanical Specifications

- **Dimensions:** 146 x 102 mm (5.7 x 4 in)
- **Height:** Top: 16.5 mm, PCB: 2.0 mm; bottom: 7.8 mm
- **Weight:** 0.67 kg (reference weight of total package)

### 1.2.4 Electrical Specifications

- **Power Requirement:** Single +12V DC  $\pm$  10% power input
- **Power Consumption:**
  - Max load
    - \* i7 7600/6600U: 22.03 W
    - \* i5 6300U: 20.87 W
    - \* i3 6100U: 20.45 W
    - \* Celeron 3955U: 17.81 W
  - Idle mode
    - \* i7 7600/6600U: 6.46 W
    - \* i5 6300U: 5.26 W
    - \* i3 6100U: 5.02 W
    - \* Celeron 3955U: 4.88 W
- **Power Consumption Conditions:**
  - Test software: 3DMark 2006
  - Max. load: Measures the maximum current value the system is under during maximum loading (CPU: Top speed, RAM & Graphic: Full loading)
  - Idle mode: Measure the current value when the system is in windows mode without running any programs.
- **RTC Battery:**
  - Typical Voltage: 3.0 V
  - Normal discharge capacity: 210 mAh

### 1.2.5 Environmental

- **Operating Temperature:** 0 ~ 60 °C (32 ~ 140 °F)
- **Operating Humidity:** 40 °C @ 95% RH Non-condensing
- **Storage Temperature:** -40 ~ 85 °C (-40 ~ 185 °F)
- **Storage Humidity:** Relative 95% @ 60 °C

<sup>1</sup> Not supported by default. Please contact Advantech if this function is needed.

<sup>2</sup> Thermal conditions need to be considered when setting maximum frequency.

## 1.3 Block Diagram

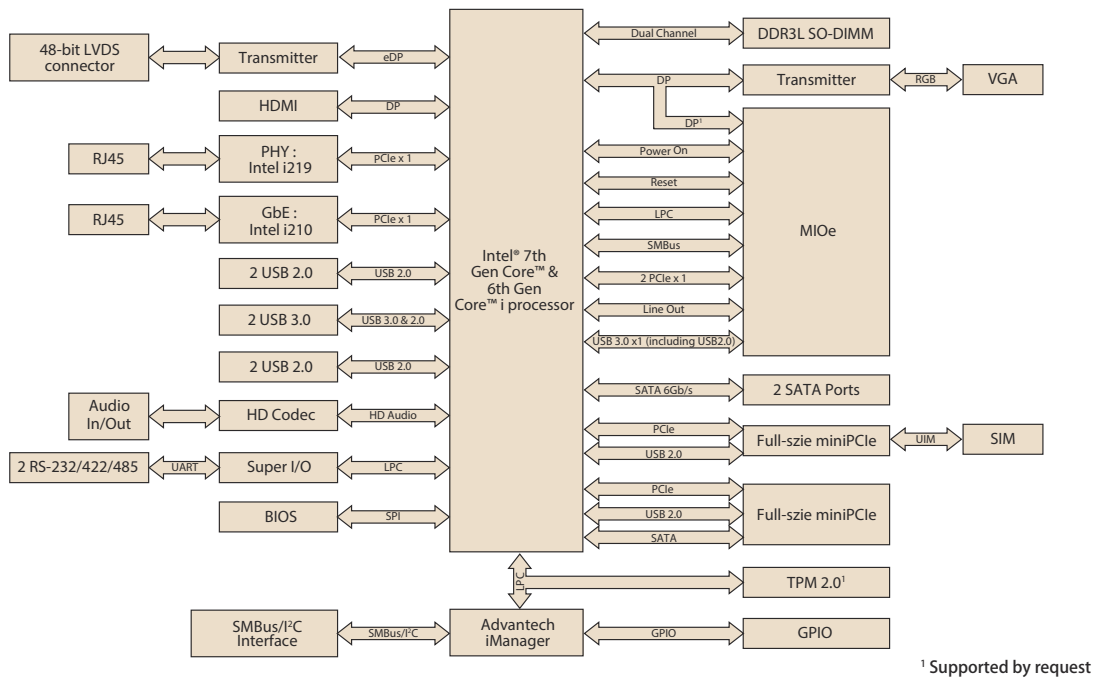

## 1.4 Board Dimensions

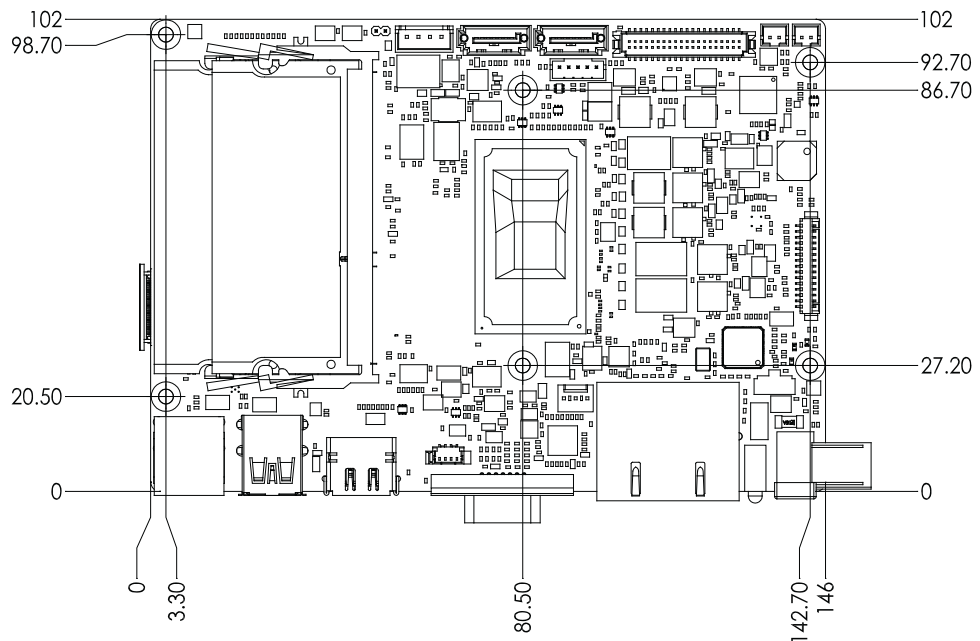

Figure 1.1 MIO-5272 Mechanical Drawing (Top Side)

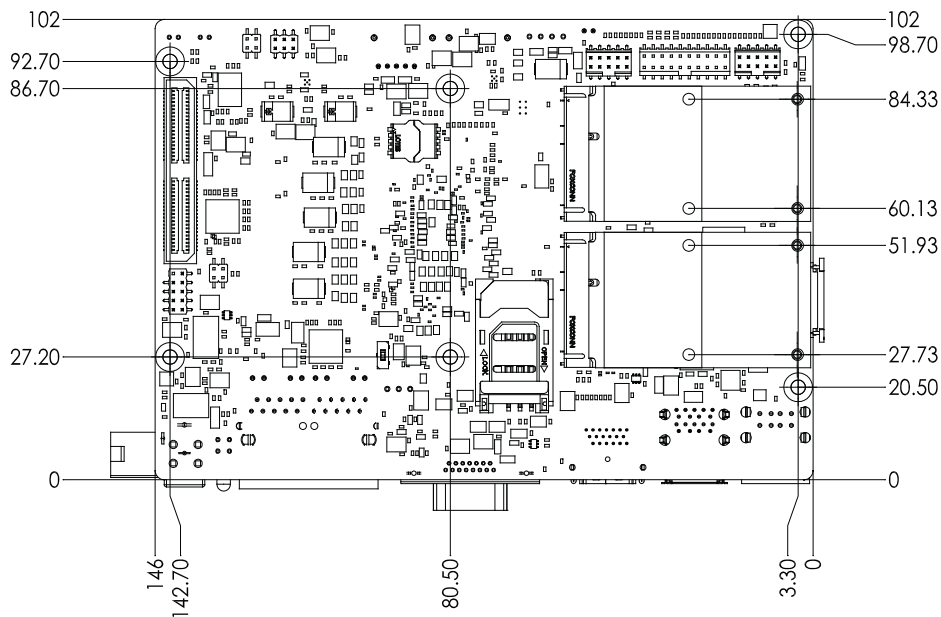

Figure 1.2 MIO-5272 Mechanical Drawing (Bottom Side)

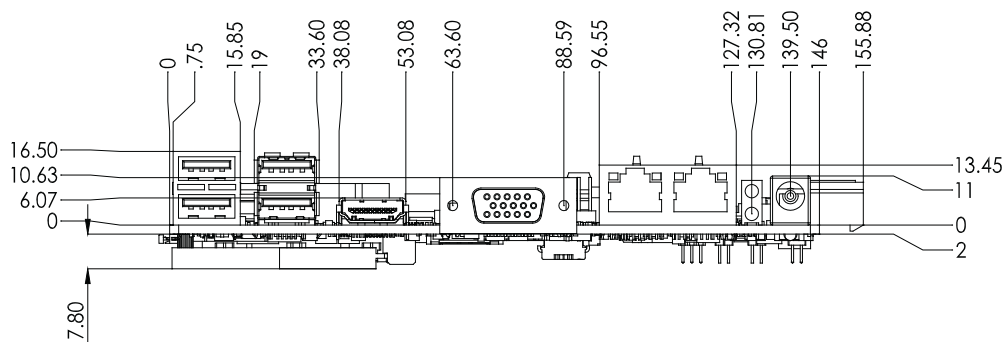
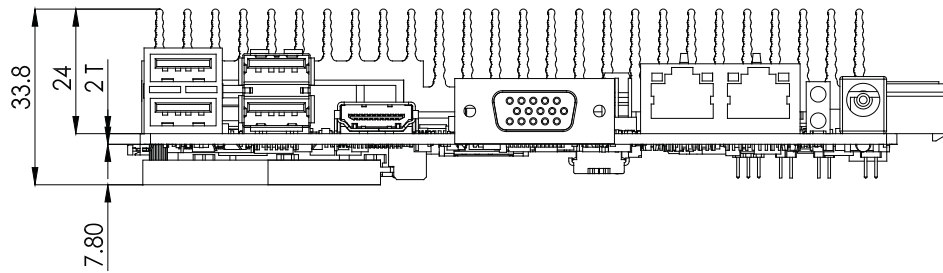
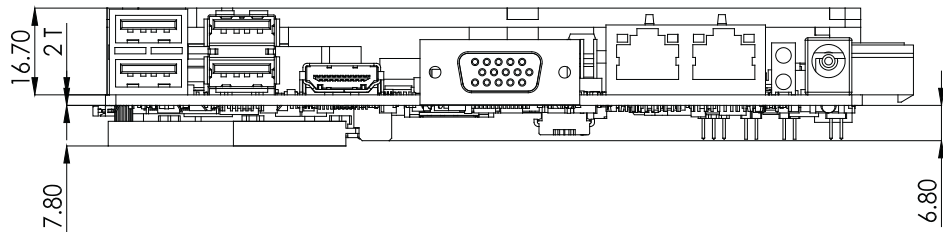

Figure 1.3 MIO-5272 Mechanical Drawing (Coastline)



**Figure 1.4 MIO-5272 Mechanical Drawing (with Heatsink)**



**Figure 1.5 MIO-5272 Mechanical Drawing (with Heat Spreader)**



# Chapter 2

## Installation

This chapter explains the setup procedures of the MIO-5272 hardware, including instructions on setting jumpers and connecting peripherals, switches and indicators. Be sure to read all safety precautions before you begin the installation procedure.

## 2.1 Jumpers & Switches

The MIO-5272 has a number of jumpers that allow you to configure your system to suit your application. The table below lists the functions of the various jumpers.

**Table 2.1: Jumpers & Switches**

J1	Auto Power On Setting
J2	LCD Power
SW2	Clear CMOS

## 2.2 Connectors

Onboard connectors link the MIO-5272 to external devices such as hard disk drives, a keyboard, or floppy drives. The table below lists the function of each of the board's connectors.

**Table 2.2: Connectors**

<b>Label</b>	<b>Function</b>
CN1	12V Power Input
CN2	DC JACK (Supported by request)
CN4	Battery
CN5	DDR3L SO-DIMM_1
CN6	DDR3L SO-DIMM_2
CN8	Power Switch
CN9	Reset
CN10	GPIO
CN11	SATA2
CN12	SATA1
CN13	SATA Power
CN14	Mini PCIE_1
CN15	mSATA or Mini PCIE_2
CN16	SIM
CN19	COM1/2 RS-232/422/485
CN21	Gigabit Ethernet 1 & 2
CN23	Audio
CN24	External USB3.0*2
CN25	External USB2.0*2
CN26	Internal USB
CN27	VGA
CN28	MIOe
CN29	SMBus
CN32	Inverter Power Output
CN33	48 bits LVDS Panel
CN34	HDMI
CN36	System FAN

## 2.3 Connector Locations

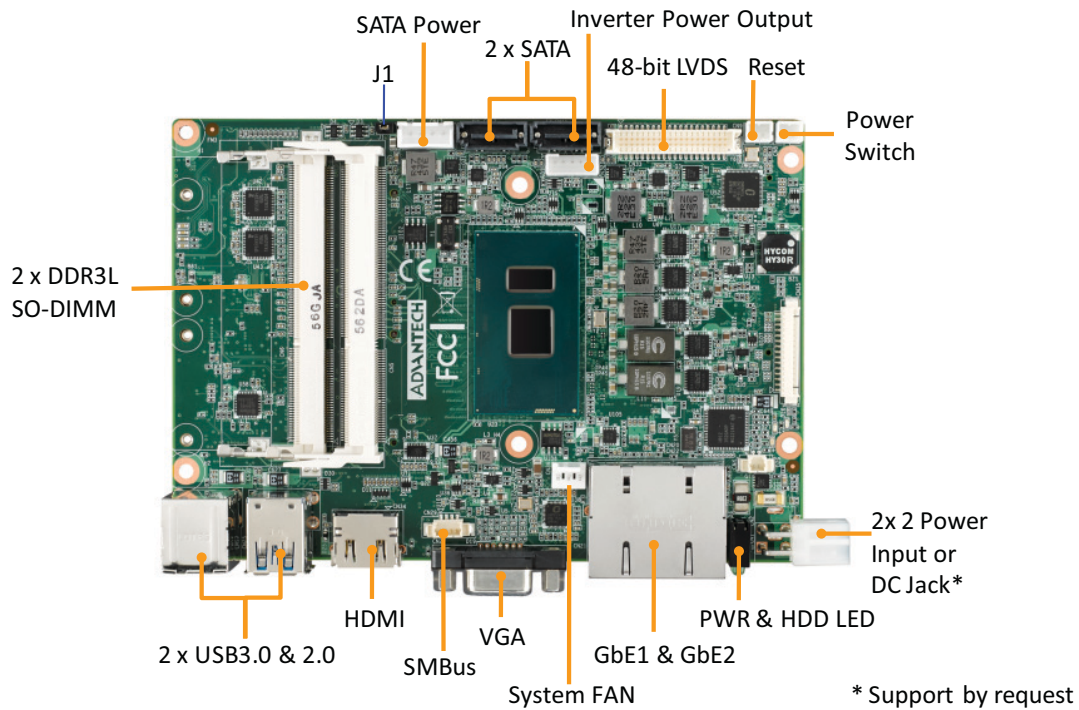

Figure 2.1 MIO-5272 Connector Locations (Top Side)

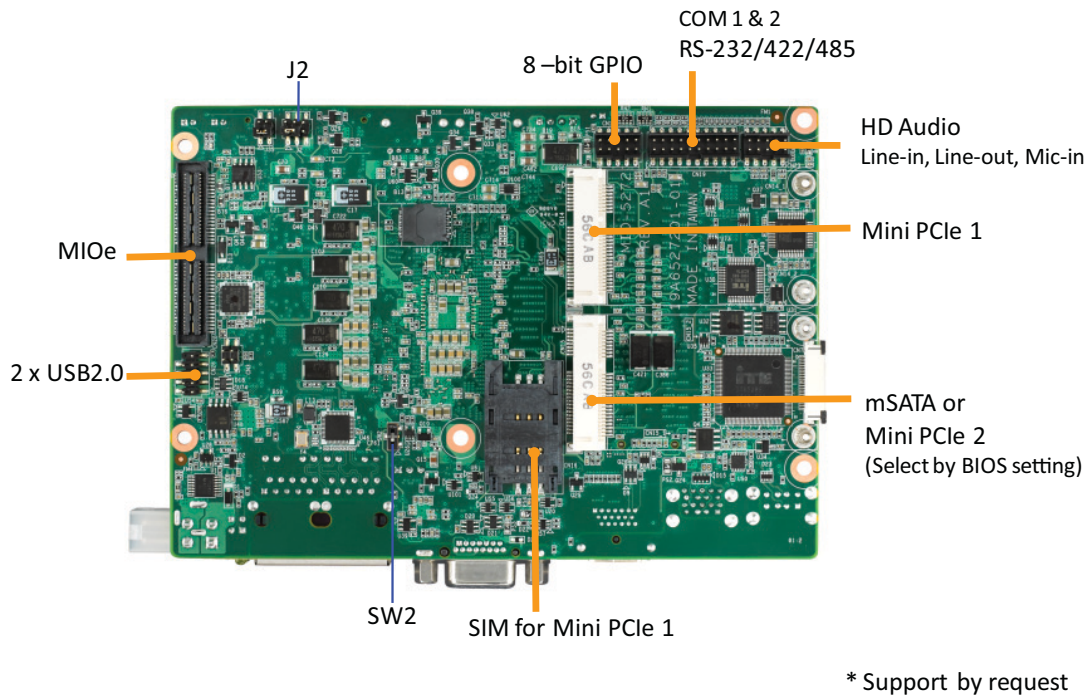
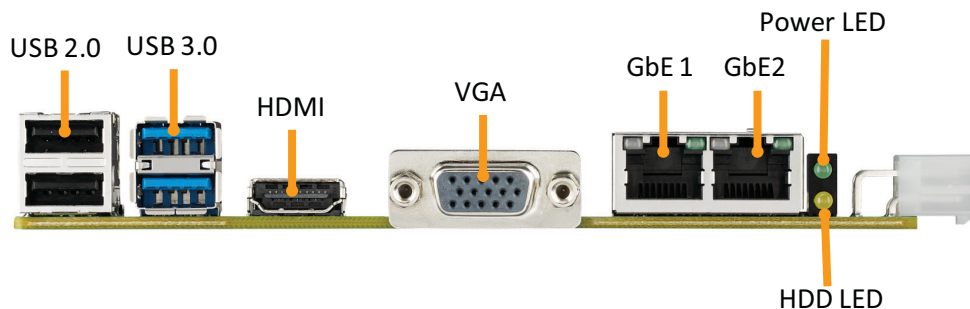

Figure 2.2 MIO-5272 Connector Locations (Bottom Side)

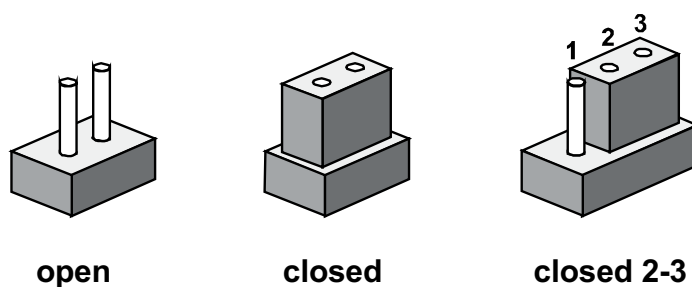

**Figure 2.3 MIO-5272 Connector Locations (Coastline)**

## 2.4 Setting Jumpers

You may configure your card to match the needs of your application by setting jumpers. A jumper is a metal bridge used to close an electric circuit. It consists of two metal pins and a small metal clip (often protected by a plastic cover) that slides over the pins to connect them. To “close” a jumper, you connect the pins with the clip. To “open” a jumper, you remove the clip. Sometimes a jumper will have three pins, labeled 1, 2 and 3. In this case you would connect either pins 1 and 2, or 2 and 3.

The jumper settings are schematically depicted in this manual as follows:



A pair of needle-nose pliers may be helpful when working with jumpers. If you have any doubts about the best hardware configuration for your application, contact your local distributor or sales representative before you make any changes. Generally, you simply need a standard cable to make most connections.

### 2.4.1 Auto Power On Setting (J1)



**Table 2.3: Auto Power On Setting (J1)**

Setting	Function
OPEN	Power Button for Power On
(Closed)*	Auto Power On (Default)

## 2.4.2 LCD Power (J2)

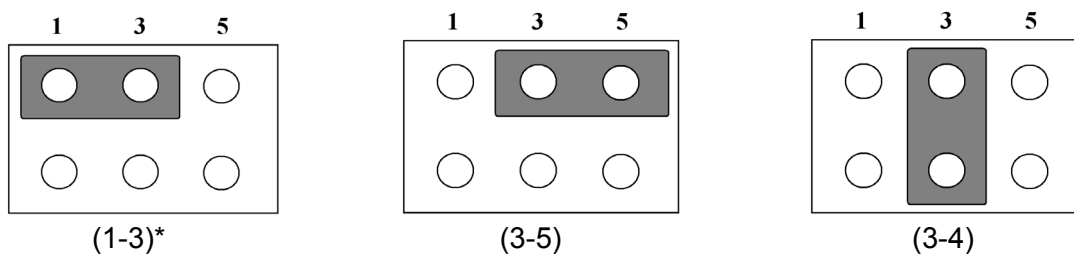

**Table 2.4: LCD Power (J2)**

Setting	Function
(1-3)*	+3.3V (Default)
(3-5)	+5V
(3-4)	+12V

## 2.4.3 Clear CMOS (SW2)



**Table 2.5: Clear CMOS (SW2)**

Setting	Function
(1-2)*	Normal
(2-3)	Clear CMOS



# Chapter 3

AMI BIOS Setup

With the AMIBIOS Setup program, you can modify BIOS settings and control the various system features. This chapter describes the basic navigation of the MIO-5272 BIOS setup screens.



**Figure 3.1 Setup Program Initial Screen**

AMI's BIOS ROM has a built-in Setup program that allows users to modify the basic system configuration. This information is stored in battery-backed CMOS so it retains the Setup information when the power is turned off.



## 3.1 Entering Setup

Turn on the computer and then press <F2> or <DEL> to enter Setup menu.

## 3.2 Main Setup

When you first enter the BIOS Setup Utility, you will encounter the Main setup screen. You can always return to the Main setup screen by selecting the Main tab. There are two Main Setup options. They are described in this section. The Main BIOS Setup screen is shown below.



**Figure 3.2 Main Setup Screen**

The Main BIOS setup screen has two main frames. The left frame displays all the options that can be configured. Grayed-out options cannot be configured; options in blue can. The right frame displays the key legend.

Above the key legend is an area reserved for a text message. When an option is selected in the left frame, it is highlighted in white. Often a text message will accompany it.

### ■ System time / System date

Use this option to change the system time and date. Highlight System Time or System Date using the <Arrow> keys. Enter new values through the keyboard. Press the <Tab> key or the <Arrow> keys to move between fields. The date must be entered in MM/DD/YY format. The time must be entered in HH:MM:SS format.

### 3.2.1 Advanced BIOS Features Setup

Select the Advanced tab from the MIO-5272 setup screen to enter the Advanced BIOS Setup screen. You can select any of the items in the left frame of the screen, such as CPU Configuration, to go to the sub menu for that item. You can display an Advanced BIOS Setup option by highlighting it using the <Arrow> keys. All Advanced BIOS Setup options are described in this section. The Advanced BIOS Setup screens are shown below. The sub menus are described on the following pages.

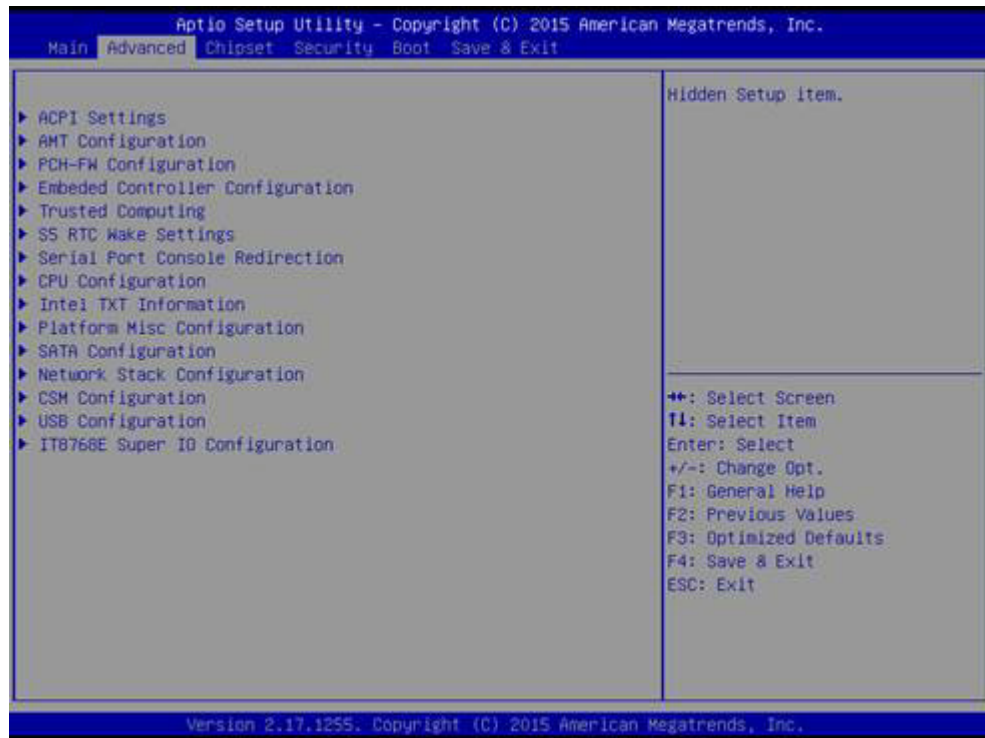
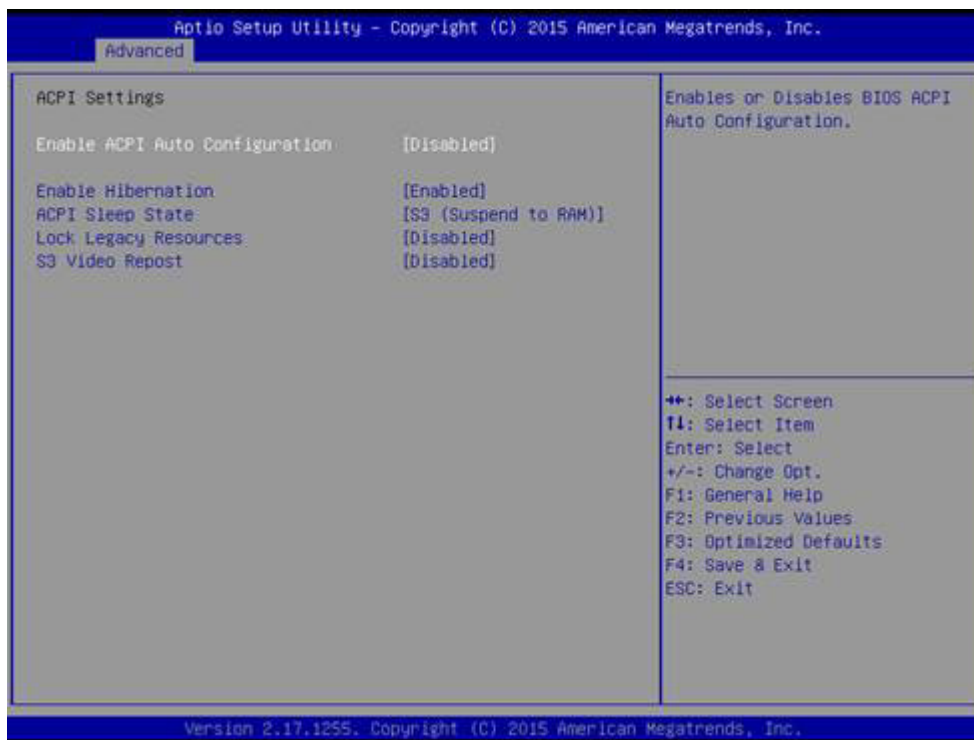

Figure 3.3 Advanced BIOS Features Setup Screen

### 3.2.1.1 PCI Subsystem Settings



**Figure 3.4 PCI Subsystem Settings**

#### **Enable ACPI Auto Configuration**

Enables or disables BIOS ACPI auto configuration.

#### **Enable Hibernation**

Enables or Disables System ability to Hibernate (OS/S4 Sleep State). This option may be not effective with some OS.

#### **ACPI Sleep State**

Select the highest ACPI sleep state the system will enter when the SUSPEND button is pressed.

#### **Lock Legacy Resources**

Enables or Disables Lock of Legacy Resources.

#### **S3 Video Repost**

Enable or Disable S3 Video Repost.

### 3.2.1.2 AMT Configuration

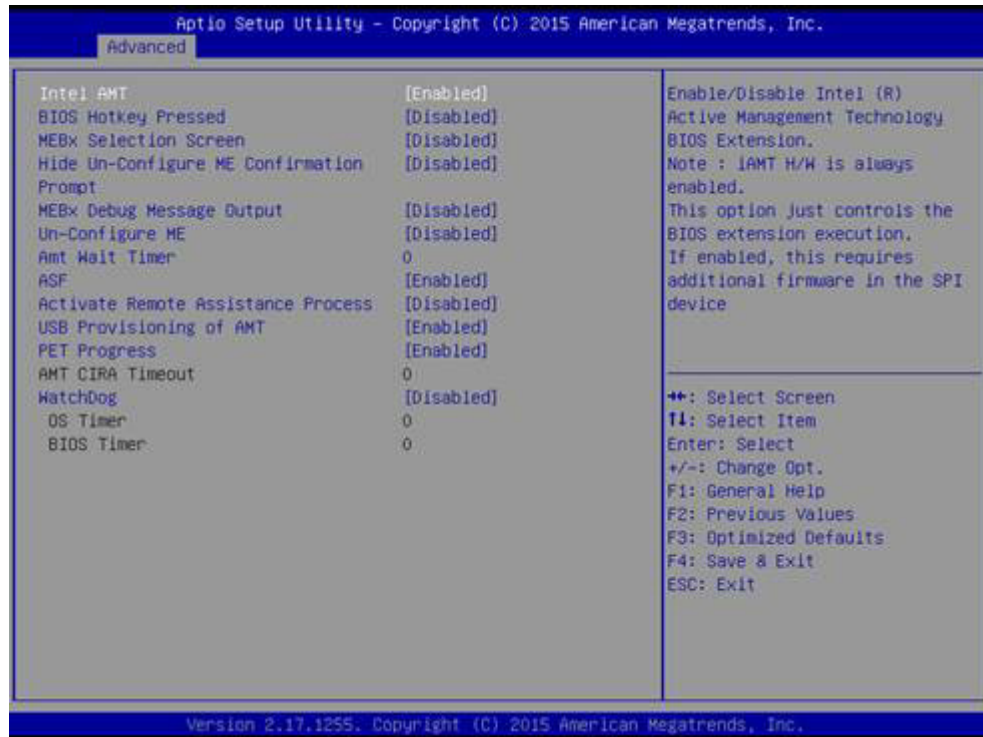

#### Intel AMT

Enable/Disable Intel® Active Management Technology BIOS Extension.

#### BIOS Hotkey Pressed

Enable/Disable BIOS hotkey press.

#### MEBx Selection Screen

Enable/Disable MEBx selection screen.

#### Hide Un-Configure ME Configuration Prompt

Hide Un-Configure ME without password configuration prompt.

#### MEBx Debug Message Output

Enable MEBx debug message output.

#### Un-Configure ME

Un-configure ME without password.

#### Amt Wait Timer

Set timer to wait before sending ASF\_GET\_BOOT\_OPTIONS.

#### ASF

Enable/Disable Alert Specification Format.

#### Activate Remote Assistance Process

Trigger CIRA boot.

#### USB Provisioning of AMT

Enable/Disable of AMT USB Provisioning.

#### PET Progress

User can Enable/Disable PET Events progress to receive PET events or not.

#### Watch Dog

Enable/Disable WatchDog Timer.

### 3.2.1.3 PCH-FW Configuration



#### PCH-FW Configuration

This page display all information about system ME FW.

#### ME Unconfig on RTC Clear State

Disabling this option will cause ME not to unconfigure on RTC clear.

#### ME State

Set ME to Soft Temporary Disabled.

#### Firmware Update Configuration

Configure Management Engine Technology Parameters.

### 3.2.1.4 Embedded Controller Configuration

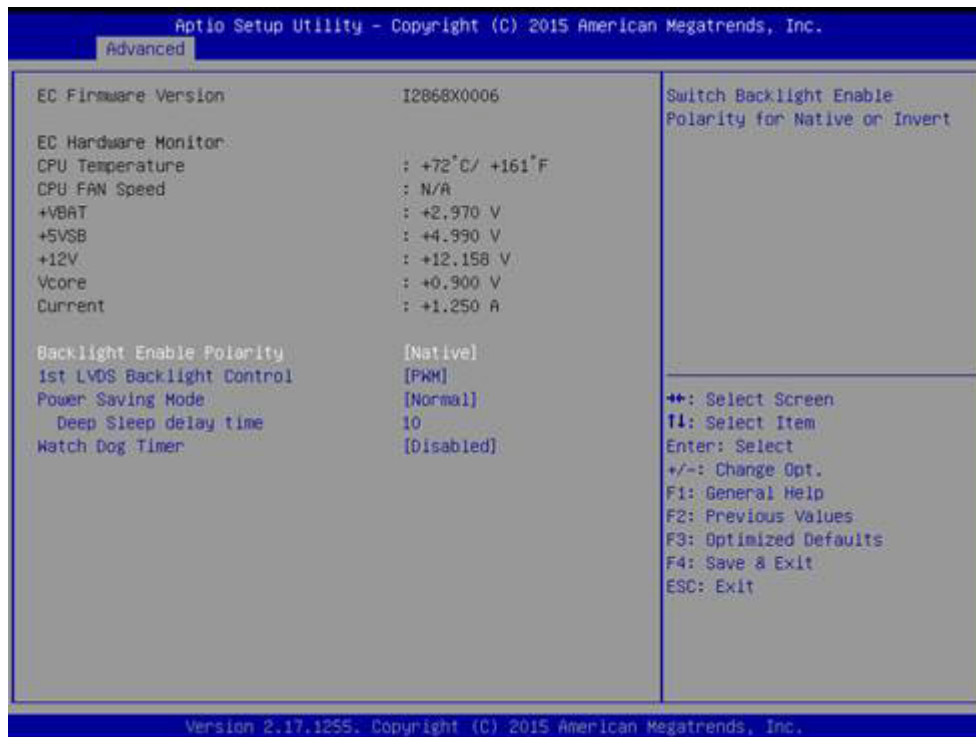

#### **EC Hardware Monitor**

This page displays all information about system Temperature/Voltage/Current.

#### **Backlight Enable Polarity**

This item allows users to set backlight mode.

#### **1st LVDS Backlight control**

This item allows users to switch Backlight Control for PWM or DC mode.

#### **Power Saving Mode**

This item allows users to set board's power saving mode when off.

#### **Deep Sleep delay time**

Set delay time for Deep Sleep mode.

#### **Watch Dog Timer**

This item allows users to select EC watchdog timer.

### 3.2.1.5 Trusted Computing

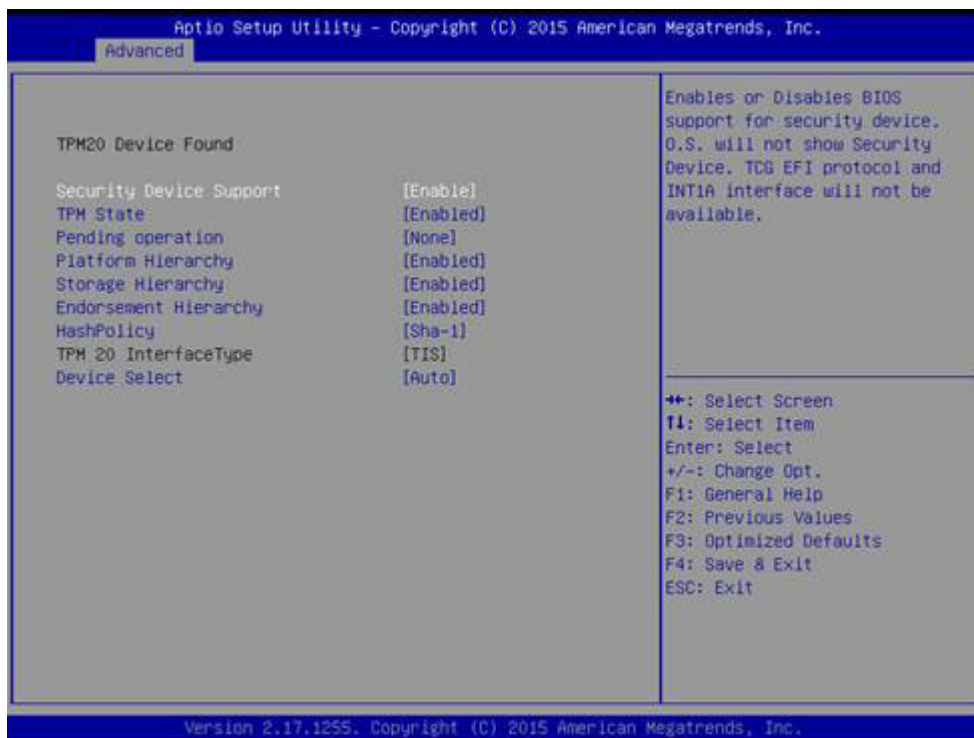

#### Trusted Computing

Enables or Disables BIOS support for security device. OS will not show security device. TCG EFI protocol and INT1A interface will not be available.

### 3.2.1.6 S5 RTC Wake Settings



#### Wake system from S5

Enable or disable System wake on alarm event. Select FixedTime, system will wake on the hr:min:sec specified.



### 3.2.1.7 Serial Port Console Redirection

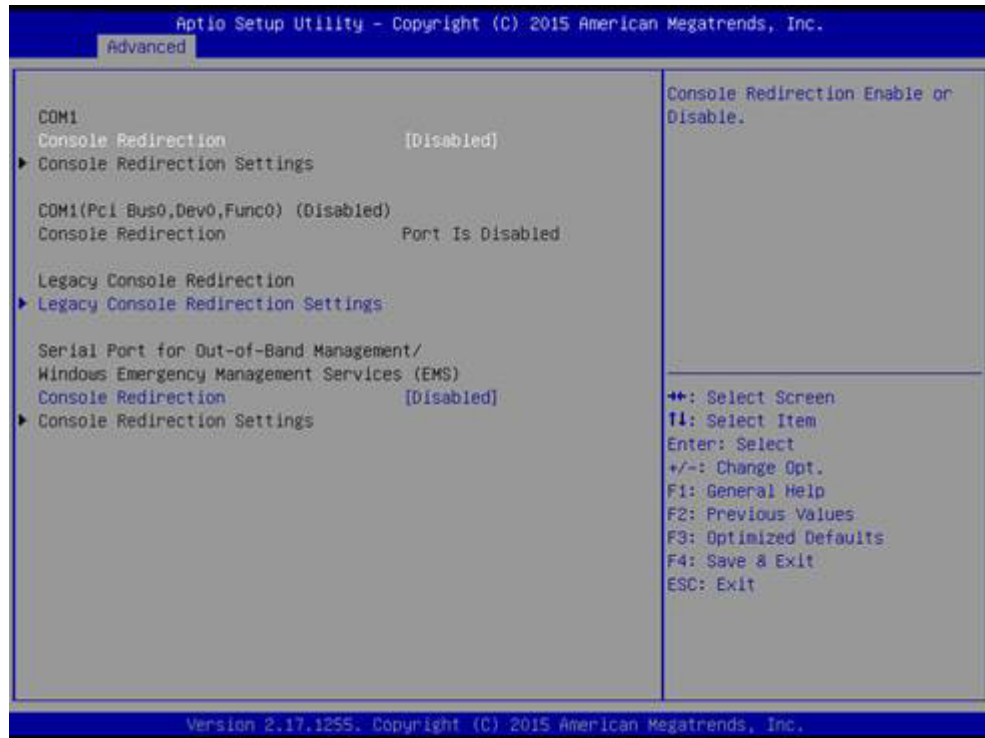

#### Console Redirection

This item allows users to enable or disable console redirection for Microsoft Windows Emergency Management Services (EMS).

#### Console Redirection Settings

This item allows users to configure console redirection detail settings.



### 3.2.1.8 CPU Configuration

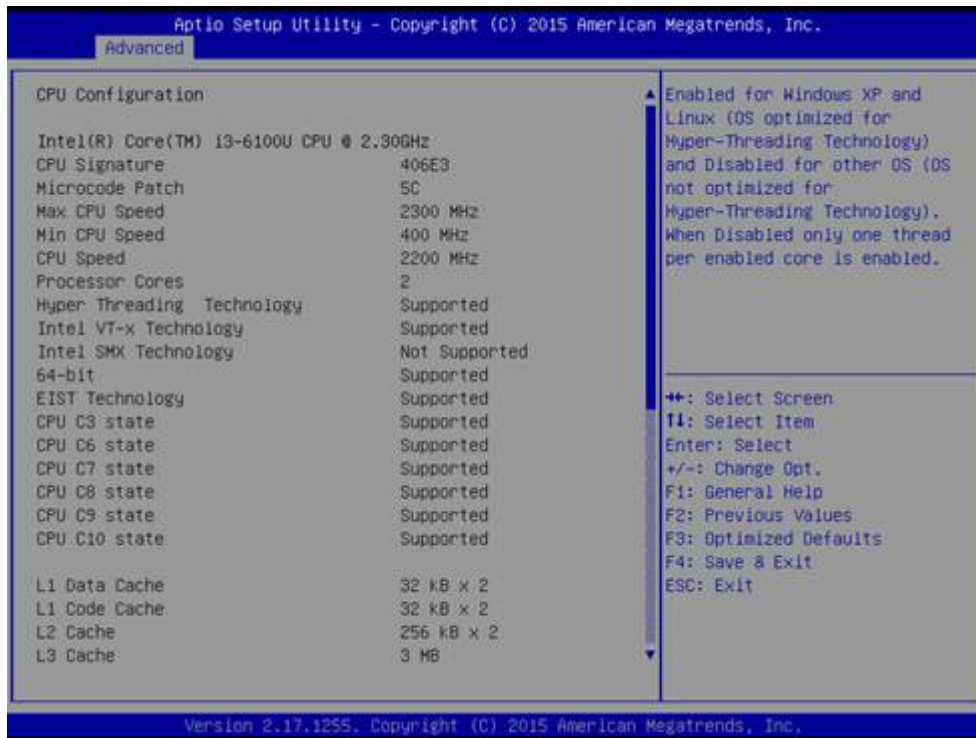

#### Hyper Threading Technology

This item allows users to enable or disable Intel Hyper Threading technology.

#### Active Processor Cores

This item allows users to set how many processor cores should be active.

#### Intel Virtualization Technology

This item allows users to enable or disable the Intel virtualization technology.

#### Hardware Prefetcher

This item allows users to enable or disable the hardware prefetcher feature.

#### Adjacent Cache Line Prefetch

This item allows users to enable or disable the adjacent cache line prefetch feature.

#### CPU AES

Enable/Disable CPU Advanced Encryption Standard instructions.

#### Boot Performance mode

Select the performance state that the BIOS will set before OS handoff.

#### Intel® Speed Shift Technology

Enable/Disable Intel® Speed Shift Technology support.

#### Intel® SpeedStep™

Allows more than two frequency ranges to be supported.

#### Turbo Mode

Turbo Mode.

#### CPU C states

Enables or disables CPU C states.

#### CState Pre-Wake

Disable – To disable CState Pre-Wake.

### Package C State limit

Package C State limit.

### SW Guard Extension (SGX)

Enable/Disable Software Guard Extensions (SGX).

#### 3.2.1.9 Intel TXT Information

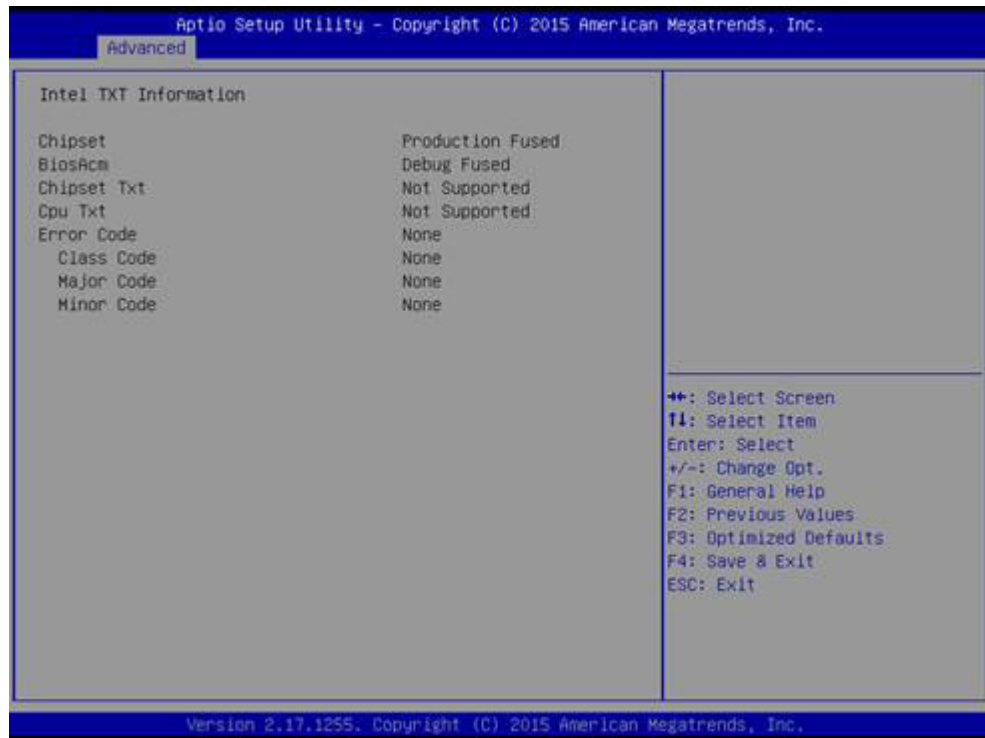

### Intel TXT Information

Display Intel TXT information.

### 3.2.1.10 Platform Misc Configuration

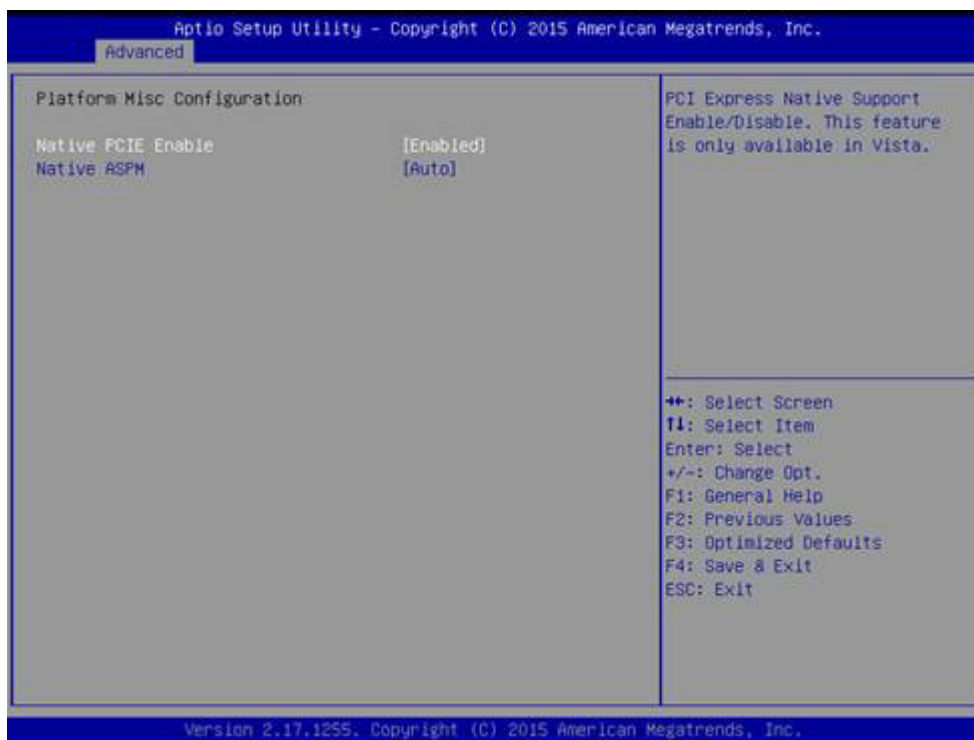

#### Native PCIE Enable

PCI Express Native Support Enable/Disable.

#### Native ASPM

PCI Express Native ASPM Enable/Disable.

### 3.2.1.11 SATA Configuration



### **SATA Controller**

Enable / Disable SATA Device.

### **SATA Mode Selection**

Determine how SATA controller operate.

### **Aggressive LPM Support**

Enable PCH to aggressively enter link power state.

### **Port 1 / Port 2 / mSATA Port**

Enable / Disable Serial ATA Port 1 / Port 2 / mSATA port.

### **SATA Device type**

Identify the SATA port is connected to Solid State Drive or Hard Disk Drive.

## **3.2.1.12 Network Stack Configuration**



### **Network Stack**

Enable/Disable UEFI Network Stack.

### 3.2.1.13 CSM Configuration



#### CSM Support

Enable/Disable CSM support.

#### GateA20 Active

This item is useful when RT code is executed above 1MB. When it's set as 'Upon Request', GA20 can be disabled using BIOS services. When it's set as 'Always', it does not allow disabling of GA20.

#### Option ROM Message

BIOS Set display mode for Option ROM.

#### INT19 Trap Response

BIOS reaction on INT19 trapping by Option ROM: IMMEDIATE - execute the trap right away; POSTPONED - execute the trap during legacy boot.

#### Boot option filter

This option controls Legacy/UEFI ROMs priority.

#### Network

Controls the execution of UEFI and Legacy PXE OpROM.

#### Storage

Controls the execution of UEFI and Legacy Storage OpROM.

#### Video

Controls the execution of UEFI and Legacy Video OpROM.

#### Other PCI devices

Determines OpROM execution policy for devices other than Network, Storage, or Video.

### 3.2.1.14 USB Configuration

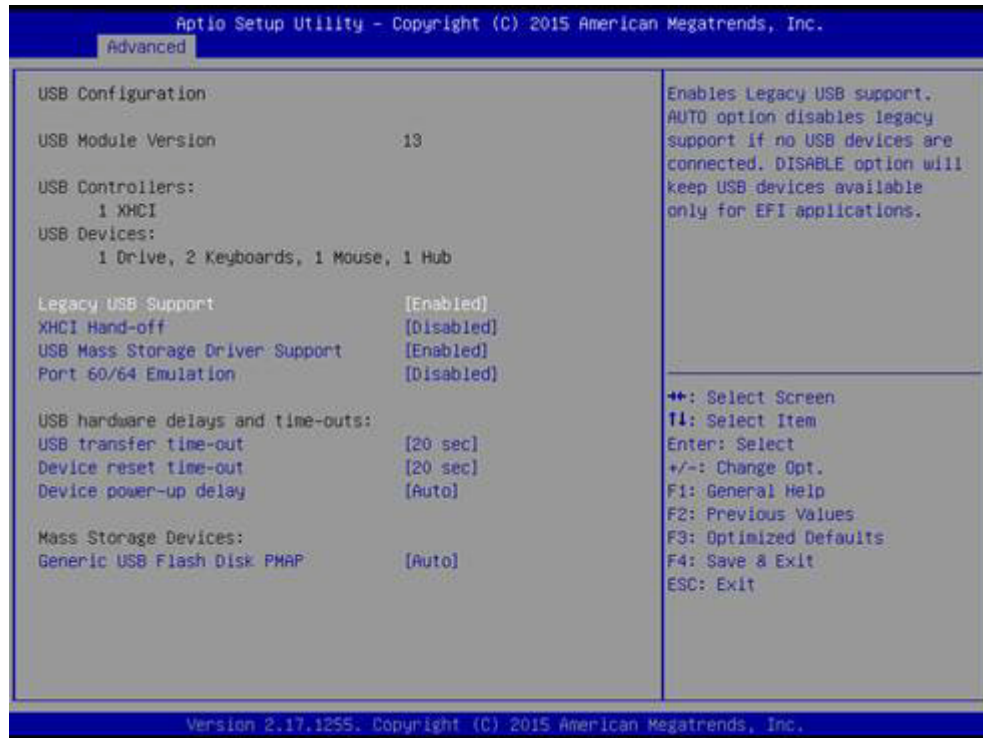

#### Legacy USB Support

Enables Legacy USB support. AUTO option disables legacy support if no USB devices are connected. Disable option will keep USB devices available only for EFI applications.

#### XHCI Hand-off

This is a workaround for OS without XHCI hand-off support. The XHCI ownership change should be claimed by XHCI driver.

#### USB Mass Storage Driver Support

Enable/Disable USB Mass Storage Driver Support.

#### Port 60/64 Emulation

Enables I/O port 60h/64h emulation support. This should be enabled for the complete USB keyboard legacy support for non-USB aware OS.

#### USB transfer time-out

Time-out value for control, Bulk, and interrupt transfers.

#### Device reset time-out

USB mass storage device start unit command time-out.

#### Device power-up delay

Maximum time the device will take before it properly reports itself to the Host Controller. 'Auto' uses default value: for a Root port it is 100 ms, for a Hub port the delay is taken from Hub descriptor.

### 3.2.1.15 IT8768E Super I/O Configuration

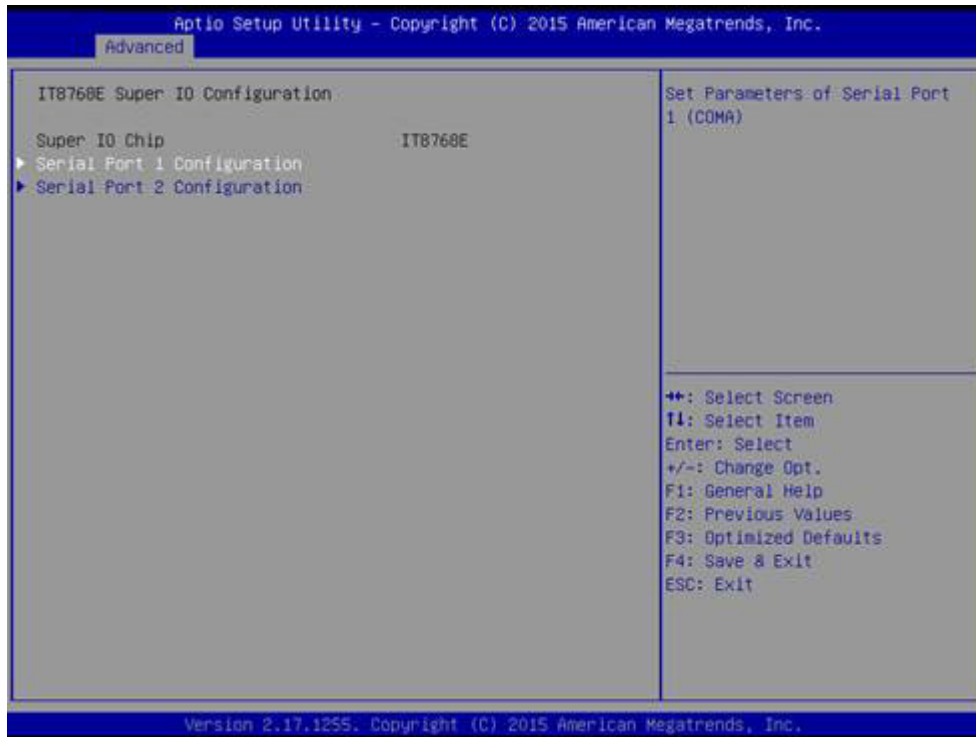

#### **Serial Port 1 Configuration**

Set Parameters of Serial Port 1 (COMA).

#### **Serial Port 2 Configuration**

Set Parameters of Serial Port 2 (COMB).

### 3.2.2 Chipset

Select the Chipset tab from the MIO-5272 setup screen to enter the Chipset BIOS Setup screen. You can display a Chipset BIOS Setup option by highlighting it using the <Arrow> keys. All Plug and Play BIOS Setup options are described in this section. The Plug and Play BIOS Setup screen is shown below.



Figure 3.5 Chipset Setup



### 3.2.2.1 System Agent (SA) Configuration



**Figure 3.6 System Agent (SA) Configuration**

#### **VT-d**

VT-D capability.

#### **CRID Support**

Enable/Disable CRID control for Intel SIPP.

#### **Above 4GB MMIO BIOS Assignment**

Enable/Disable above 4GB memory mapped IO BIOS assignment.

### 3.2.2.2 Graphics Configuration

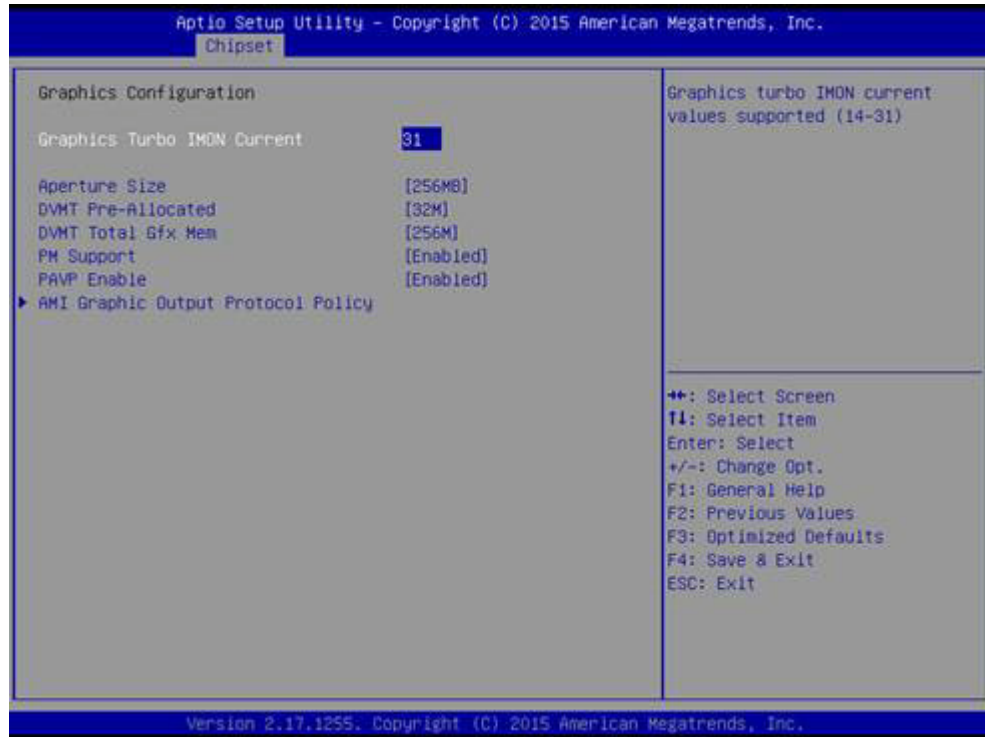

#### Graphics Turbo IMON Current

Graphics turbo IMON current values supported.

#### Aperture Size

Select Aperture Size.

#### DVMT Pre-Allocated

Select DVMT 5.0 Pre-Allocated (Fixed) graphics memory size used by the Internal Graphics Device.

#### DVMT Total Gfx Mem

Select DVMT 5.0 Total Gfx Memory size used by the Internal graphics device.

#### PM Support

Enable/Disable PM support.

#### PAVP Enable

Enable/Disable PAVP.

### 3.2.2.3 Boot Display Control



#### Primary IGFX Boot Display

Select the Video Device which will be activated during POST. This has no effect if an external graphics present. Secondary boot display selection will appear based on your selection. VGA modes will be supported only on primary display.

#### LVDS Panel Type

This item allow user to select LVDS panel type.

#### 2nd LVDS Backlight Control

Switch LVDS Backlight Control for PWM or DC mode.

### 3.2.2.4 Memory Configuration Options

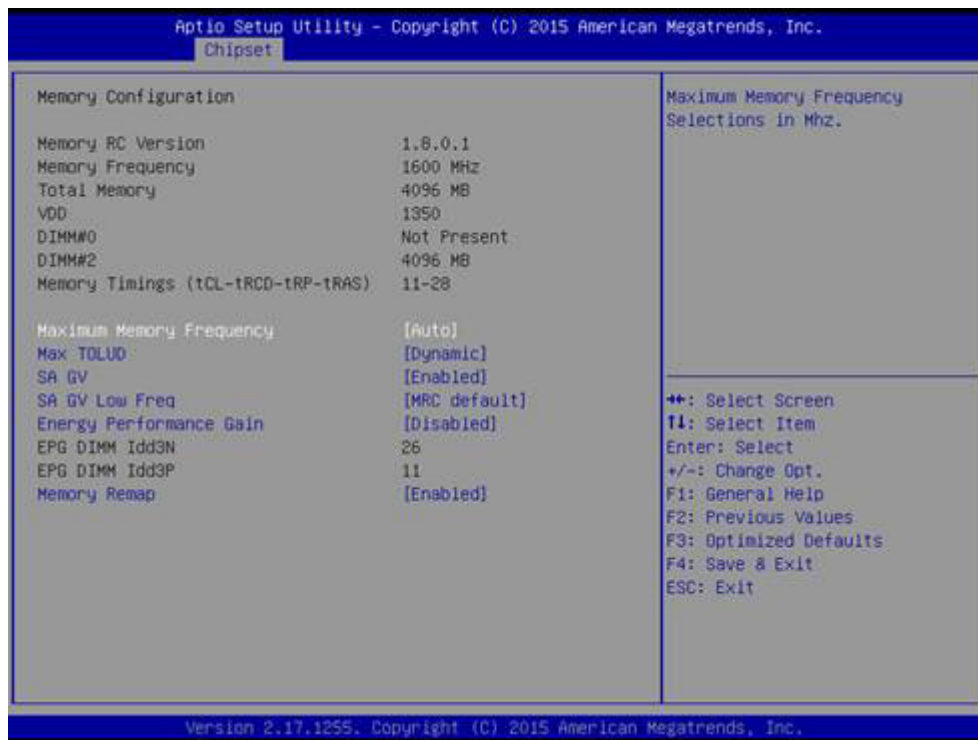

#### **Maximum Memory Frequency**

Maximum memory frequency selections in Mhz.

#### **Max TOLUD**

Maximum value of TOLUD.

#### **SA GV**

System Agent Geyserville.

#### **SA GV Low Freq**

System Agent Geyserville. Set frequency for low point.

#### **Energy Performance Gain**

Enable/disable Energy Performance Gain.

#### **Memory Remap**

Enable/Disable Memory Remap above 4GB.

### 3.2.2.5 GT – Power Management Control

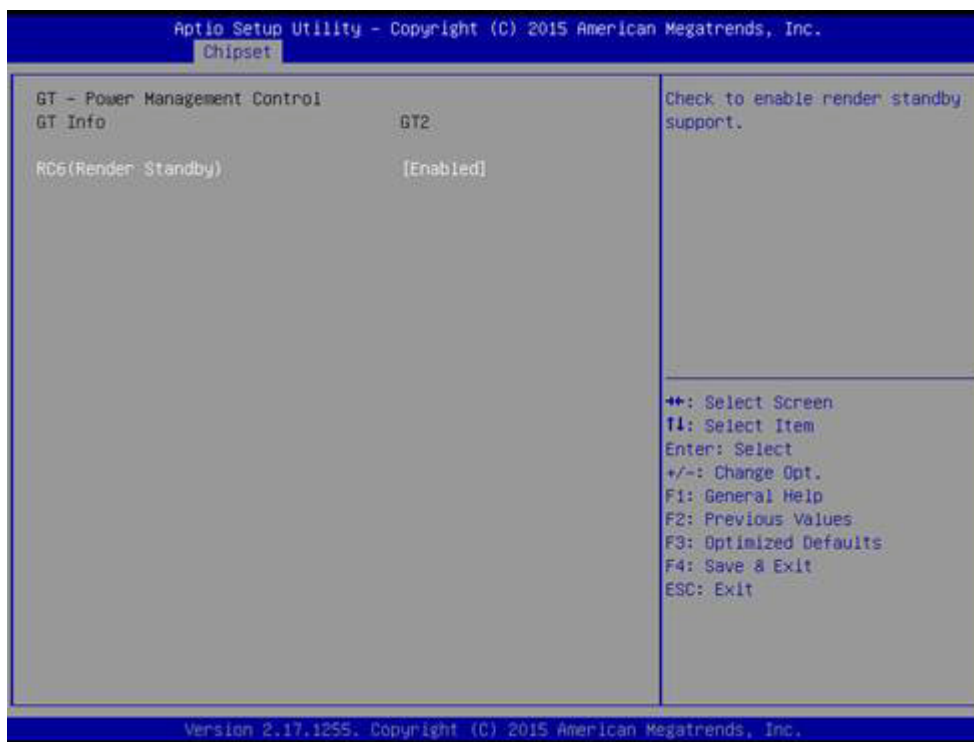

#### RC6 Render Standby)

Check to enable render standby support.

### 3.2.2.6 PCH-IO Configuration



#### PCI Express Configuration

PCI Express Configuration Settings.

---

### **USB Configuration**

USB Configuration settings.

### **BIOS Security Configuration**

BIOS Security configuration settings.

### **HD Audio Configuration**

HD Audio subsystem configuration settings.

### **SB Porting Configuration**

SB Porting Configuration Settings.

### **Mini PCIE/mSATA Selection**

Select to enable Mini PCIE or mSATA for connector (CN25).

### **PCH LAN Controller**

Enable or Disable onboard NIC.

### **LAN Option ROM**

Enable or Disable onboard LAN's PXE option ROM.

### **Wake on LAN**

Enable or Disable Integrated LAN to wake the system from S5.

### **Onboard LAN2 Controller**

Enable or Disable onboard NIC.

### **LAN Option ROM**

Enable or Disable onboard LAN's PXE option ROM.

### **PCIE Wake**

Enable or Disable PCIE to wake the system from S5.

### **High Precision Timer**

Enable or Disable High Precision Event Timer.

### **State After S3**

Specify what state to go to when power is re-applied after a power failure (G3 state).

### 3.2.2.7 PCI Express Configuration

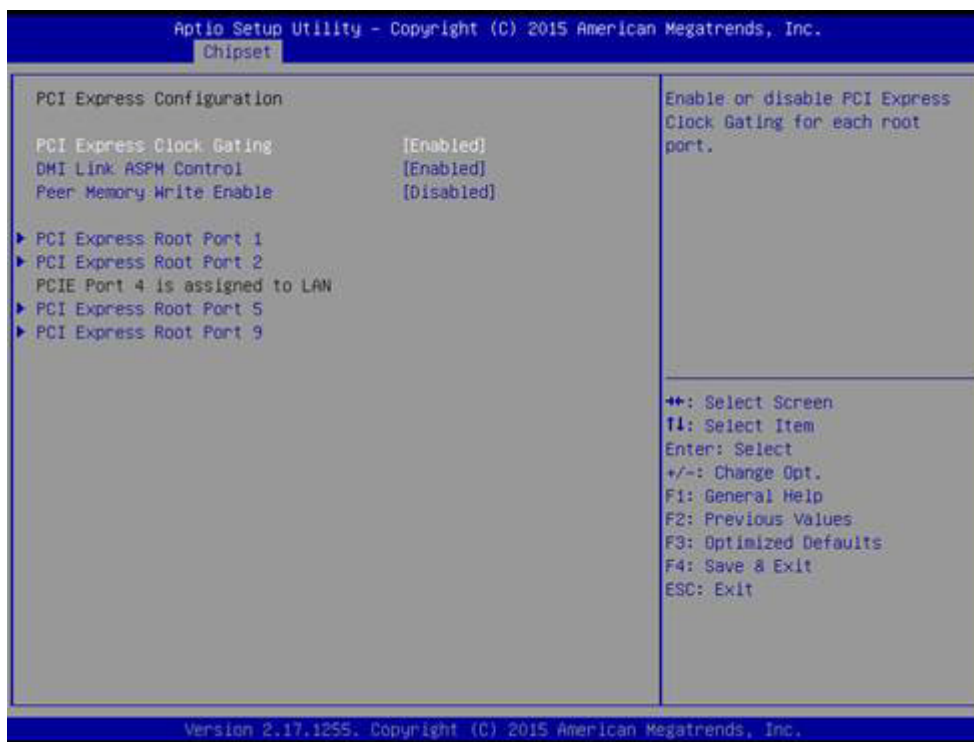

#### PCI Express Clock Gating

Enables or disables PCI Express Clock Gating for each root port.

#### DMI Link ASPM Control

Enable/Disable the control of Active State Power Management on SA side of the DMI Link.

#### Peer Memory Write Enable

Peer Memory Write Enable/Disable.

#### PCI Express Root Port 1/2/5/9

PCI Express Port 1/2/5/9 Settings.

### 3.2.2.8 USB Configuration



#### **USB Precondition**

Precondition work on USB host controller and root ports for faster enumeration.

#### **XHCI Disable Compliance mode**

Option to Disable Compliance Mode.

#### **USB Port Disable Override**

Selectively Enable/Disable the corresponding USB Port from reporting a device connection to the controller.



### 3.2.2.9 BIOS Security Configuration



#### RTC Lock

Enable will lock bytes 38h-3Fh in the lower/upper 128-byte bank of RTC RAM.

#### BIOS Lock

Enable or Disable the PCH BIOS Lock Enable feature.

### 3.2.2.10 HD Audio Configuration



## HD Audio

Control Detection of the HD-Audio device. Disabled = HDA will be unconditionally disabled. Enabled = HDA will be unconditionally Enabled.

### 3.2.2.11 SB Porting Configuration

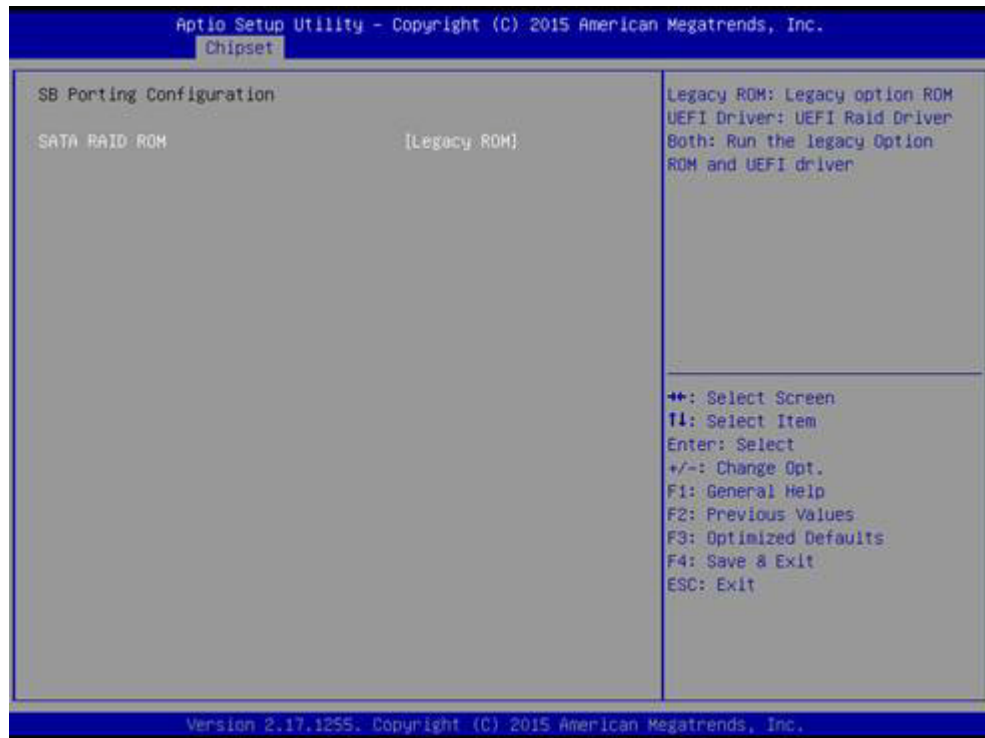

## SATA RAID ROM

Run the Legacy ROM or UEFI Driver.

### 3.2.3 Security

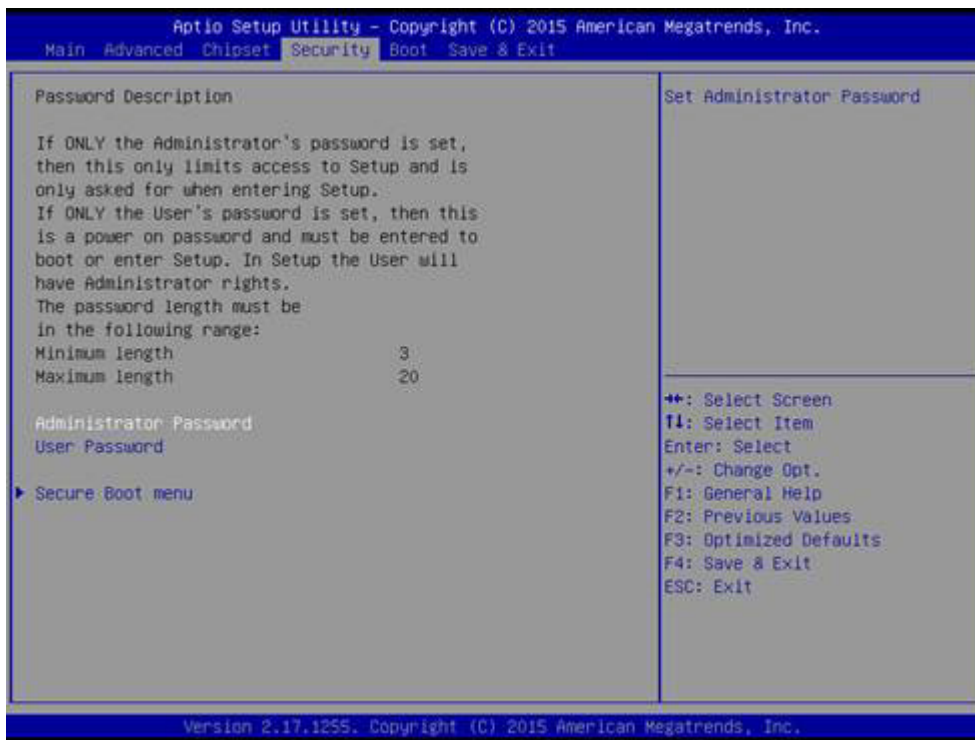

**Figure 3.7 Password Configuration**

Select Security Setup from the MIO-5272 Setup main BIOS setup menu. All Security Setup options, such as password protection and virus protection are described in this section. To access the sub menu for the following items, select the item and press <Enter>:

**Change Administrator / User Password:** Select this option and press <ENTER> to access the sub menu, and then type in the password.

## 3.2.4 Boot

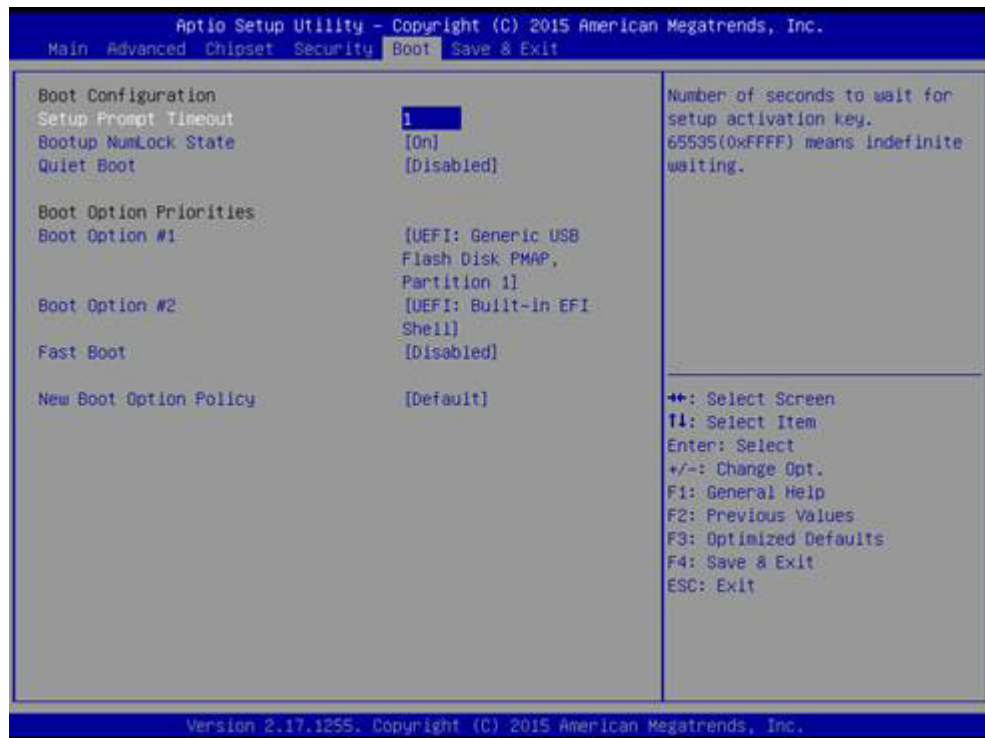

Figure 3.8 Boot

### Setup Prompt Timeout

Number of seconds that the firmware will wait before initiating the original default boot selection. A value of 0 indicates that the default boot selection is to be initiated immediately on boot. A value of 65535(0xFFFF) indicates that firmware will wait for user input before booting. This means the default boot selection is not automatically started by the firmware.

### Bootup NumLock State

Select the keyboard NumLock state.

### Quiet Boot

Enables or disables Quiet Boot option.

### Boot Option #1

Sets the system boot order.

### Fast Boot

Enables or disables boot with initialization of a minimal set of devices required to launch active boot option. Has no effect for BBS boot options.

### New Boot Option Policy

Controls the placement of newly detected UEFI boot options.

### 3.2.5 Save & Exit



**Figure 3.9 Save & Exit**

#### **Save Changes and Exit**

When users have completed system configuration, select this option to save changes, exit BIOS setup menu and reboot the computer if necessary to take effect of all system configuration parameters.

#### **Discard Changes and Exit**

Select this option to quit Setup without making any permanent changes to the system configuration.

#### **Save Changes and Reset**

When users have completed system configuration, select this option to save changes, exit BIOS setup menu and reboot the computer to take effect of all system configuration parameters.

#### **Discard Changes and Reset**

Select this option to quit Setup without making any permanent changes to the system configuration and reboot the computer.

#### **Save Changes**

When users have completed system configuration, select this option to save changes without exit BIOS setup menu.

#### **Discard Changes**

Select this option to discard any current changes and load previous system configuration.

#### **Restore Defaults**

The MIO-5272 automatically configures all setup items to optimal settings when users select this option. Optimal Defaults are designed for maximum system performance, but may not work best for all computer applications. In particular, do not use the Optimal Defaults if the user's computer is experiencing system configuration problems.

---

**Save as User Defaults**

When you have completed system configuration, select this option to save changes as user defaults without exiting the BIOS setup menu.

**Restore User Defaults**

Select this option to restore user defaults.

**Boot Override**

Allows users to choose boot device.

# Chapter 4

MIOe Installation

The MI/O compact form factor SBC is a new-generation SBC design with a variety of mechanical improvements. Here is the quick installation guide for our thermal design and MIOe module installation.

## 4.1 Quick Installation Guide

1. There is a heatsink/cooler in the white box inside the package. Carefully remove the release paper from the thermal pad before installation.

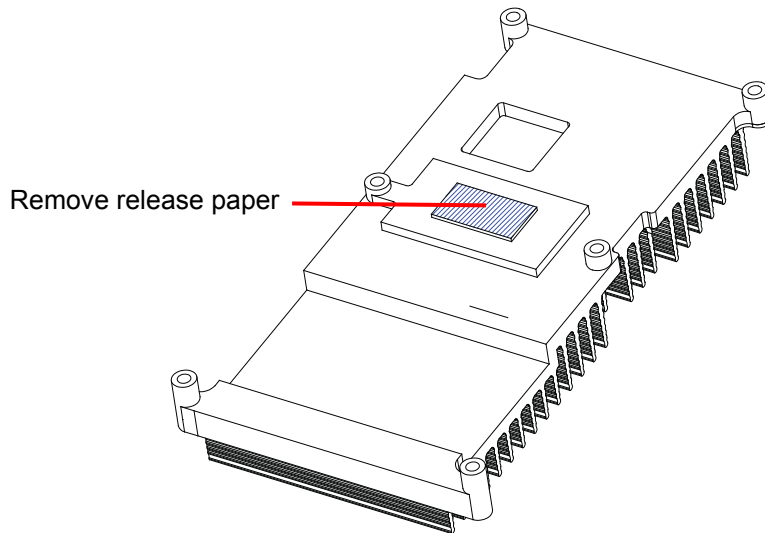

2. There are eight screws, six studs, and two nuts inside the white box, please install the heatsink into place and follow assembly sequence below:

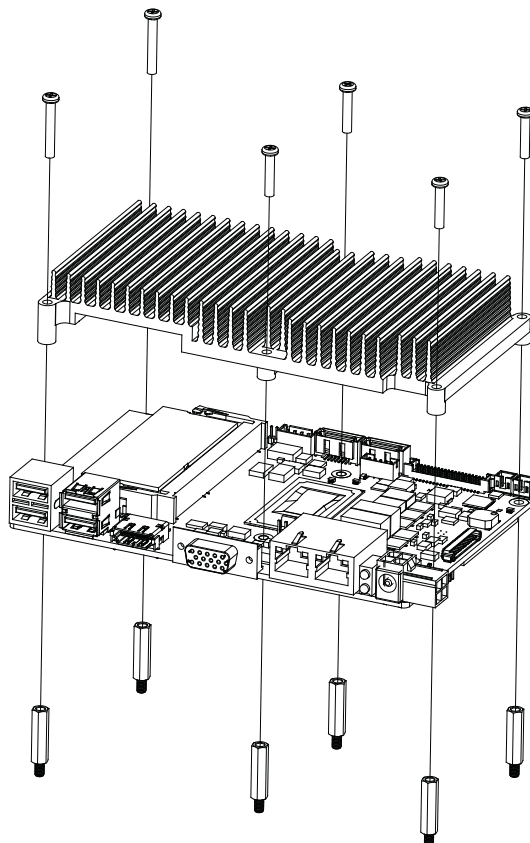



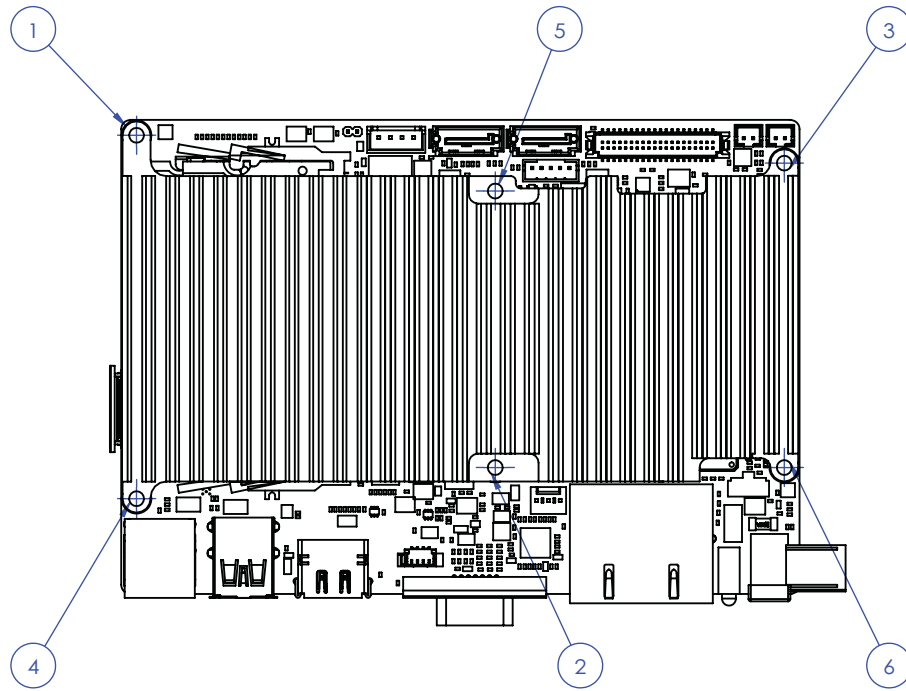



# Appendix **A**

## Pin Assignments

This appendix contains information of a detailed or specialized nature.

- Jumper and Connector Tables

## A.1 Jumper, Switch List, and Settings

<b>J1</b>	<b>Auto Power On Setting</b>
<b>Part Number</b>	1653002101
<b>Footprint</b>	HD_2x1P_79_D
<b>Description</b>	PIN HEADER 2*1P 180D(M) SQUARE 2.0mm DIP W/O Pb
<b>Setting</b>	Function
(1-2)*	Auto Power On (default)

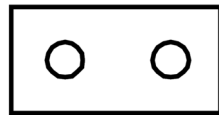

OPEN

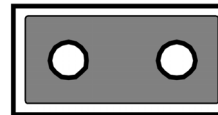

Closed

<b>J2</b>	<b>LCD Power</b>
<b>Part Number</b>	1653003260
<b>Footprint</b>	HD_3x2P_79
<b>Description</b>	PIN HEADER 3x2P 2.0mm 180D(M) SMD 21N22050
<b>Setting</b>	Function
(1-3)*	+3.3V (default)
(3-5)	+5V
(3-4)	+12V

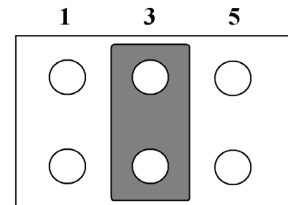
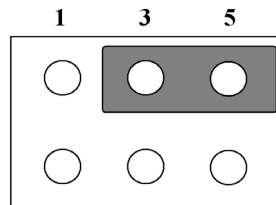
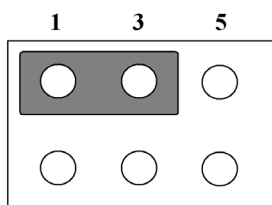

<b>SW2</b>	<b>Clear CMOS</b>
<b>Part Number</b>	1600000071
<b>Footprint</b>	SW_3P_CJS-1201TA1
<b>Description</b>	DIP SW CJS-1201TA1 SMD 3P SPDT P=6.0mm W=2.5mm
<b>Pin</b>	Function
2->1	Normal
2->3	Clear CMOS (RTC RST#)

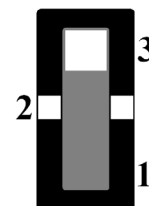
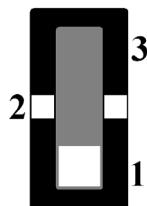

<b>CN1</b>	<b>12V Power Input</b>
<b>Part Number</b>	1655003865
<b>Footprint</b>	WF_2x2P_165_BOX_RA_D_740SP
<b>Description</b>	ATX PWRCONN 2x2P 4.2mm 90D(M) DIP 740-77-04TS50
Pin	Pin Name
1	GND
2	GND
3	+12V
4	+12V

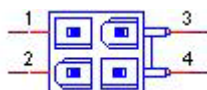

<b>CN2</b>	<b>DC JACK (Support available upon request)</b>
<b>Part Number</b>	1652005278
<b>Footprint</b>	PJ_2P_2DC-G213B200
<b>Description</b>	
Pin	Pin Name
1	+12V
2	GND
3	NC



<b>CN4</b>	<b>Battery</b>
<b>Part Number</b>	1655005427-01
<b>Footprint</b>	WF_2P_49_53398-0271
<b>Description</b>	WAFER BOX 2P 1.25mm 180D(M) DIP 53047-0210
Pin	Pin Name
1	+3V
2	GND



<b>CN5</b>	<b>DDR3L SO-DIMM_1</b>
<b>Part Number</b>	1651002088
<b>Footprint</b>	SODIMMDDR3_204P_AS0A626-HA
<b>Description</b>	DDR3 SODIMM H=9.2mm 204P SMD AS0A626-HASN-7H

<b>CN6</b>	<b>DDR3L SO-DIMM_2</b>
<b>Part Number</b>	1651002087-11
<b>Footprint</b>	DDR3_204P_AS0A626-N2S6-7H

<b>CN8</b>	<b>Power Switch</b>
<b>Part Number</b>	1655302020
<b>Footprint</b>	WF_2P_79_BOX_R1_D
<b>Description</b>	WAFER BOX 2P 2.0mm 180D(M) DIP A2001WV2-2P
<b>Pin</b>	<b>Pin Name</b>
1	PSIN
2	GND



<b>CN9</b>	<b>Reset</b>
<b>Part Number</b>	1655302020
<b>Footprint</b>	WF_2P_79_BOX_R1_D
<b>Description</b>	WAFER BOX 2P 2.0mm 180D(M) DIP A2001WV2-2P
<b>Pin</b>	<b>Pin Name</b>
1	RESET#
2	GND



<b>CN10</b>	<b>GPIO</b>
<b>Part Number</b>	1653004099
<b>Footprint</b>	HD_5x2P_79_23N685B-10M10
<b>Description</b>	BOX HEADER 5x2P 2.00mm 180D(M) SMD 23N685B-10M10
Pin	Pin Name
1	+5V
2	GPIO4
3	GPIO0
4	GPIO5
5	GPIO1
6	GPIO6
7	GPIO2
8	GPIO7
9	GPIO3
10	GND

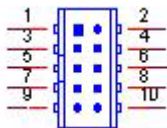

<b>CN11</b>	<b>SATA</b>
<b>Part Number</b>	1654007578
<b>Footprint</b>	SATA_7P_WATF-07DBN6SB1U
<b>Description</b>	Serial ATA 7P 1.27mm 180D(M) SMD WATF-07DBN6SB1U
Pin	Pin Name
1	GND
2	TX+
3	TX-
4	GND
5	RX-
6	RX+
7	GND

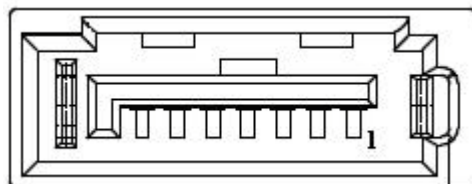

<b>CN12</b>	<b>SATA</b>
<b>Part Number</b>	1654011616-01
<b>Footprint</b>	SATA_7P_WATF-07DBN6SB1U
<b>Description</b>	Serial ATA 7P 1.27mm 180D(M) SMD WATF-07DBLSB1UW
<b>Pin</b>	<b>Pin Name</b>
1	GND
2	TX+
3	TX-
4	GND
5	RX-
6	RX+
7	GND

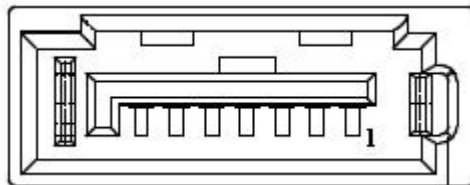

<b>CN13</b>	<b>SATA Power</b>
<b>Part Number</b>	1655001154
<b>Footprint</b>	WF_4P_98_BOX_R1_D
<b>Description</b>	WAFER BOX 4P 2.50mm 180D(M) DIP 24W1170-04S10-01
<b>Pin</b>	<b>Pin Name</b>
1	+5V
2	GND
3	GND
4	+12V

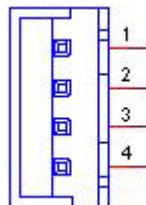



<b>CN14</b>	<b>Mini PCIE</b>
<b>Part Number</b>	1654002538
<b>Footprint</b>	MINIPCIE_HALF_PICO_ITX
<b>Description</b>	MINI PCI E 52P 6.8mm 90D SMD AS0B226-S68N7H
<b>Pin</b>	<b>Pin Name</b>
1	WAKE#
2	+3.3VSB
3	NC
4	GND
5	NC
6	+1.5V
7	CLK_MIN1_z_REQ#
8	+VUIM_PWR
9	GND
10	UIM_DATA
11	REFCLK-
12	UIM_CLK
13	REFCLK+
14	UIM_RESET
15	GND
16	+VUM_VPP
17	NC
18	GND
19	NC
20	W_DISABLE#
21	GND
22	PERST#
23	PERn0
24	+3.3VSB
25	PERp0
26	GND
27	GND
28	+1.5V
29	GND
30	SMB_CLK
31	PETn0
32	SMB_DATA
33	PETp0
34	GND
35	GND
36	USB D-
37	GND
38	USB D+
39	+3.3VSB
40	GND
41	+3.3VSB
42	NC

43	GND
44	NC
45	NC
46	NC
47	NC
48	+1.5V
49	NC
50	GND
51	NC
52	+3.3VSB

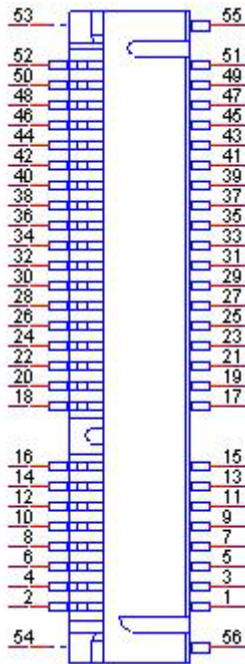

<b>CN15</b>	<b>mSATA or Mini PCIE2</b>
Part Number	1654002538
Footprint	MINIPCIE_HALF_PICO_ITX
Description	MINI PCI E 52P 6.8mm 90D SMD AS0B226-S68N7H
Pin	Pin Name
1	WAKE#
2	+3.3VSB
3	NC
4	GND
5	NC
6	+1.5V
7	NC
8	UIM_PWR
9	GND
10	UIM_DATA
11	REFCLK-
12	UIM_CLK
13	REFCLK+
14	UIM_RESET
15	GND
16	UIM_VPP
17	NC
18	GND
19	NC
20	W_DISABLE#
21	GND
22	PERST#
23	PERn0
24	+3.3VSB
25	PERp0
26	GND
27	GND
28	+1.5V
29	GND
30	SMB_CLK
31	PETn0
32	SMB_DAT
33	PETp0
34	GND
35	GND
36	USB D-
37	GND
38	USB D+
39	+3.3VSB
40	GND
41	+3.3VSB
42	NC

43	SEL
44	NC
45	NC
46	NC
47	NC
48	+1.5V
49	NC
50	GND
51	NC
52	+3.3VSB

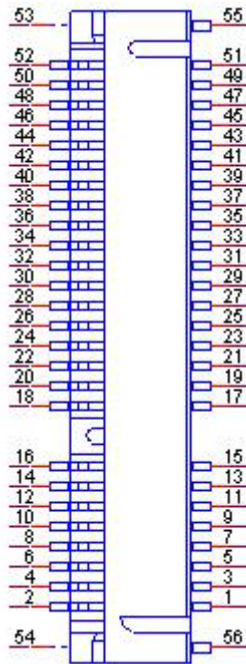

<b>CN15</b>	<b>SIM</b>
<b>Part Number</b>	1654010809-01
<b>Footprint</b>	SIM_6P_5210622-SINR03
<b>Description</b>	
Pin	Pin Name
C1	UIM_PWR
C2	UIM_RESET
C3	UIM_CLK
C5	GND
C6	UIM_VPP
C7	UIM_DATA

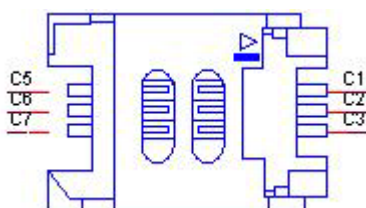

<b>CN16</b>	<b>External USB 2.0+USB 3.0</b>
<b>Part Number</b>	1654010199
<b>Footprint</b>	USB_13P_UEA1112C-UHS6-4F
<b>Description</b>	
Pin	Pin Name
1	+5V
2	D-
3	D+
4	GND
5	SSRX-
6	SSRX+
7	GND
8	SSTX-
9	SSTX+
10	+5V
11	D-
12	D+
13	GND

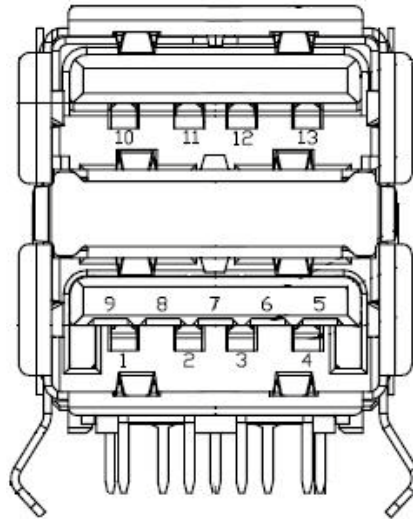

<b>CN17</b>	<b>External USB 2.0+USB 3.0</b>
<b>Part Number</b>	1654010199
<b>Footprint</b>	USB_13P_UEA1112C-UHS6-4F
<b>Description</b>	
Pin	Pin Name
1	+5V
2	D-
3	D+
4	GND
5	SSRX-
6	SSRX+
7	GND
8	SSTX-
9	SSTX+
10	+5V
11	D-
12	D+
13	GND

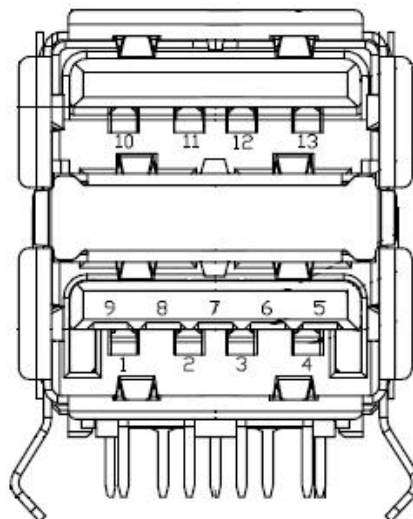

<b>CN18</b>	<b>COM1/COM2</b>
<b>Part Number</b>	1653004793
<b>Footprint</b>	HD_10x2P_79_23N685B-20M10
<b>Description</b>	BOX HEADER 10x2P 2.0mm 180D(M)SMD 23N685B-20M10B
Pin	Pin Name
1	DCD1#
2	DSR1#
3	RXD1
4	RTS1#
5	TXD1
6	CTS1#
7	DTR1#
8	RI1#
9	GND
10	GND
11	DCD2#
12	DSR2#
13	RXD2
14	RTS2#
15	TXD2
16	CTS2#
17	DTR2#
18	RI2#
19	GND
20	GND

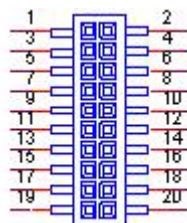

Matching Cable: 1701200220

<b>CN19</b>	<b>COM3/COM4/RS422/RS485</b>
<b>Part Number</b>	1653004793
<b>Footprint</b>	HD_10x2P_79_23N685B-20M10
<b>Description</b>	BOX HEADER 10x2P 2.0mm 180D(M)SMD 23N685B-20M10B
<b>Pin</b>	<b>Pin Name</b>
1	COM3_485-422_TXN-DCD#
2	COM3_z_DSR#
3	COM3_485-422_TXP-RXD
4	COM3_z_RTS#
5	COM3_422__RXP-TXD
6	COM3_z_CTS#
7	COM3_422__RXN-DTR#
8	COM3_z_RI#
9	GND
10	GND
11	COM4_485-422_TXN-DCD#
12	COM4_z_DSR#
13	COM4_485-422_TXP-RXD
14	COM4_z_RTS#
15	COM4_422__RXP-TXD
16	COM4_z_CTS#
17	COM4_422__RXN-DTR#
18	COM4_z_RI#
19	GND
20	GND

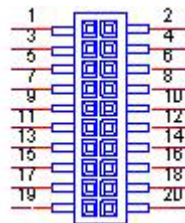



<b>CN19</b>	<b>COM1/2 RS-232/422/485</b>
Part Number	1653004793
Footprint	HD_10x2P_79_23N685B-20M10
Description	BOX HEADER 10x2P 2.0mm 180D(M)SMD 23N685B-20M10B
Pin	Pin Name
1	422TX<1>-/485D<1>-/DCD<1>#
2	DSR<1>#
3	422TX<1>+/485D<1>+/RXD<1>
4	RTS<1>#
5	422RX<1>+/TXD<1>
6	CTS<1>#
7	422RX<1>-/DTR<1>#
8	RI<1>#
9	GND
10	GND
11	422TX<2>-/485D<2>-/DCD<2>#
12	DSR<2>#
13	422TX<2>+/485D<2>+/RXD<2>
14	RTS<2>#
15	422RX<2>+/TXD<2>
16	CTS<2>#
17	422RX<2>-/DTR<2>#
18	RI<2>#
19	GND
20	GND

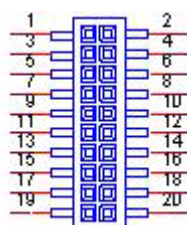

<b>CN21</b>	<b>Gigabit Ethernet 1 &amp; 2</b>
<b>Part Number</b>	1652003274
<b>Footprint</b>	RJ45_28P_RTB-19GB9J1A
<b>Description</b>	PHONE JACK RJ45 28P DIP RTB-19GB9J1A
<b>Pin</b>	<b>Pin Name</b>
1	TX+(10/100),BI_DA+(GHz)
2	TX-(10/100),BI_DA-(GHz)
3	RX+(10/100),BI_DB+(GHz)
4	BI_DC+(GHz)
5	BI_DC-(GHz)
6	RX-(10/100),BI_DB-(GHz)
7	BI_DD+(GHz)
8	BI_DD-(GHz)

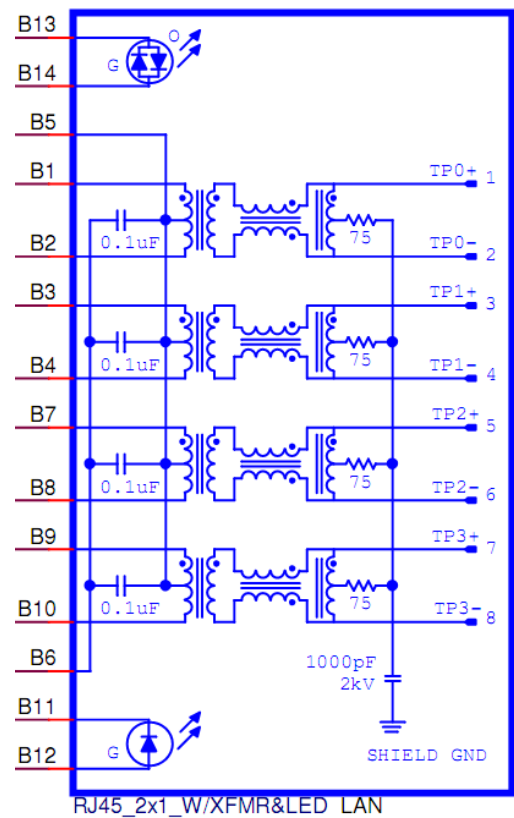
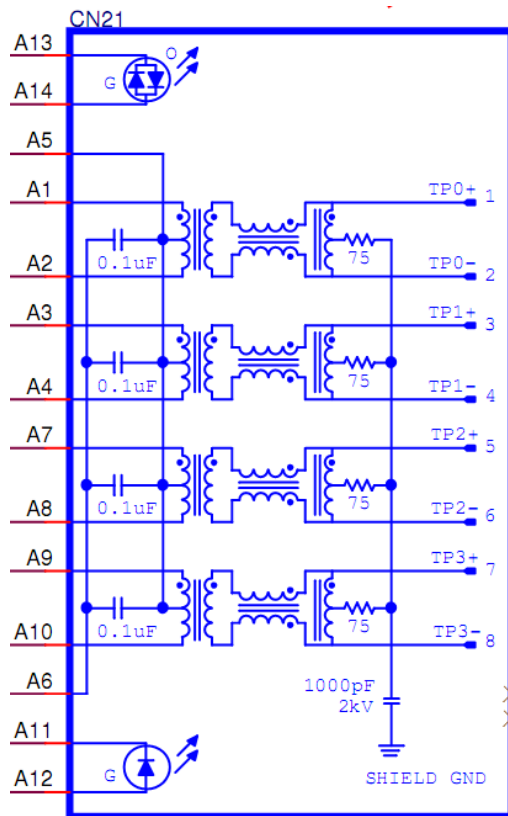

<b>CN23</b>	<b>Audio</b>
<b>Part Number</b>	1653004099
<b>Footprint</b>	HD_5x2P_79_23N685B-10M10
<b>Description</b>	BOX HEADER 5x2P 2.00mm 180D(M) SMD 23N685B-10M10
Pin	Pin Name
1	LOUTR
2	LINR
3	GND
4	GND
5	LOUTL
6	LINL
7	GND
8	GND
9	MIC1R
10	MIC1L

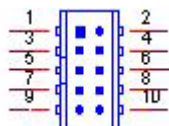

<b>CN24</b>	<b>External USB 3.0*2</b>
<b>Part Number</b>	1654011725-01
<b>Footprint</b>	USB_9x2P_WDU3R-18F3B4PBUW3
<b>Description</b>	Double USB 3.0 CONN. 18P 90D(F) DIP WDU3R-18F6B4
Pin	Pin Name
1	+5V
2	D-
3	D+
4	GND
5	SSRX-
6	SSRX+
7	GND
8	SSTX-
9	SSTX+
10	+5V
11	D-
12	D+
13	GND
14	SSRX-
15	SSRX+
16	GND
17	SSTX-
18	SSTX+

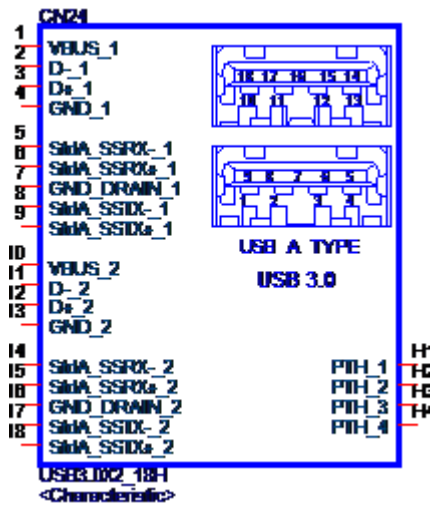

<b>CN25</b>	<b>External USB 2.0*2</b>
<b>Part Number</b>	1654010634-01
<b>Footprint</b>	USB_8P_ABA-USB-014-K01
<b>Description</b>	USB Conn. 8P 2.5mm 90D(M) DIP ABA-USB-014-K01
<b>Pin</b>	<b>Pin Name</b>
1	+5V
2	D-
3	D+
4	GND
5	+V5
6	D-
7	D+
8	GND
9	GND
10	GND
11	GND
12	GND

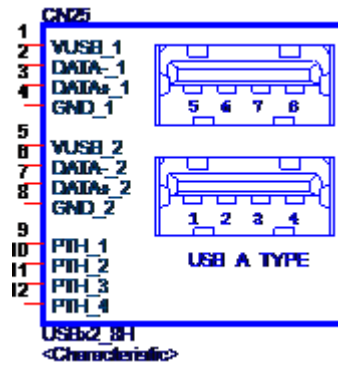

<b>CN26</b>	<b>Internal USB</b>
<b>Part Number</b>	1653005260
<b>Footprint</b>	HD_5x2P_79_N10
<b>Description</b>	PIN HEADER 2x5P 2.0mm 180D(M) SMD 21N22050
Pin	Pin Name
1	+5V
2	+5V
3	A_D-
4	B_D-
5	A_D+
6	B_D+
7	GND
8	GND
9	GND

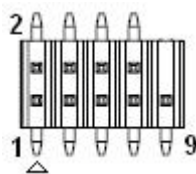

<b>CN27</b>	<b>VGA</b>
<b>Part Number</b>	1654011261-01
<b>Footprint</b>	DBVGA-VF5MS
<b>Description</b>	D-sub 15P 90D(F) DIP G/F HDB5-15F1-KNR0-G7
Pin	Pin Name
1	RED
2	GREEN
3	BLUE
4	NC
5	GND
6	GND
7	GND
8	GND
9	+5V
10	GND
11	NC
12	DDAT
13	HSYNC
14	VSYNC
15	DCLK

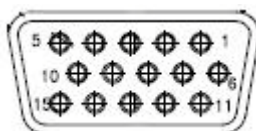

<b>CN28</b>	<b>MIOe</b>
<b>Part Number</b>	1654006235
<b>Footprint</b>	BB_40x2P_32_1625x285_2HOLD
<b>Description</b>	B/B Conn. 40x2P 0.8mm 180D(F) SMD QSE-040-01-L-D
Pin	Pin Name
1	GND
2	GND
3	PCIE_MIO_RX1+
4	PCIE_MIO_TX1+
5	PCIE_MIO_RX1-
6	PCIE_MIO_TX1-
7	GND
8	GND
9	PCIE_MIO_RX2+
10	PCIE_MIOE_TX2+
11	PCIE_MIO_RX2-
12	PCIE_MIO_TX2-
13	GND
14	GND
15	NC
16	NC
17	NC
18	NC
19	GND
20	GND
21	NC
22	NC
23	NC
24	NC
25	GND
26	GND
27	PCIE_CLK+
28	LOUTL
29	PCIE_CLK-
30	LOUTR
31	GND
32	AGND
33	SMB_STB_CLK
34	NC
35	SMB_STB_DAT
36	NC
37	PCIE_WAKE#
38	NC
39	RESET#
40	NC
41	PowerOn
42	CLK33M

43	NC
44	LPC_AD0
45	DDP_HPD
46	LPC_AD1
47	GND
48	LPC_AD2
49	DDP_AUX+
50	LPC_AD3
51	DDP_AUX-
52	NC
53	GND
54	LPC_SERIRQ
55	DDP_D0+
56	LPC_FRAME#
57	DDP_D0-
58	GND
59	GND
60	USB7_P+
61	DDP_D1+
62	USB7_P-
63	DDP_D1-
64	GND
65	GND
66	USB4_SSTX+
67	DDP_D2+
68	USB4_SSTX-
69	DDP_D2-
70	GND
71	GND
72	USB4_SSRX+
73	DDP_D3+
74	USB4_SSRX-
75	DDP_D3-
76	GND
77	GND
78	USB_OC#
79	+12VSB
80	+12VSB
83	GND
84	GND
85	GND
86	GND
87	+5VSB
88	+5VSB
89	+5VSB
90	+5VSB

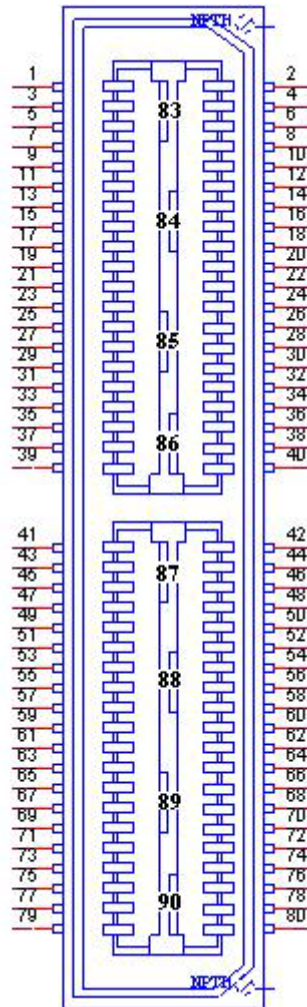

<b>CN29</b>	<b>SMBus</b>
Part Number	1655904020
Footprint	FPC4V-125M
Description	WAFER 4P 1.25mm 180D(M) SMD 85205-04001
Pin	Pin Name
1	GND
2	SMB_DAT
3	SMB_CLK
4	+5V

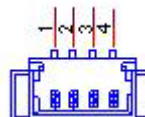



<b>CN32</b>	<b>Inverter Power Output</b>
<b>Part Number</b>	1655000453
<b>Footprint</b>	WHL5V-2M-24W1140
<b>Description</b>	WAFER BOX 2.0mm 5P 180D(M) DIP WO/Pb JIH VEI
Pin	Pin Name
1	+12V
2	GND
3	ENABKL
4	PWM
5	+5V

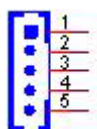

<b>CN34</b>	<b>LVDS Panel (48 bit)</b>
<b>Part Number</b>	1653920200
<b>Footprint</b>	SPH20X2
<b>Description</b>	B/B Conn. 40P 1.25mm 90D SMD DF13-40DP-1.25V(91)
Pin	Pin Name
1	+V_LCD
2	+V_LCD
3	GND
4	GND
5	+V_LCD
6	+V_LCD
7	LVDS0_D0-
8	LVDS1_D0-
9	LVDS0_D0+
10	LVDS1_D0+
11	GND
12	GND
13	LVDS0_D1-
14	LVDS1_D1-
15	LVDS0_D1+
16	LVDS1_D1+
17	GND
18	GND
19	LVDS0_D2-
20	LVDS1_D2-
21	LVDS0_D2+
22	LVDS1_D2+
23	GND
24	GND
25	LVDS0_CLK-

26	LVDS1_CLK-
27	LVDS0_CLK+
28	LVDS1_CLK+
29	GND
30	GND
31	NC
32	NC
33	GND
34	GND
35	LVDS0_D3-
36	LVDS1_D3-
37	LVDS0_D3+
38	LVDS1_D3+
39	NC
40	NC



<b>CN34</b>	<b>HDMI</b>
<b>Part Number</b>	1654012492-01
<b>Footprint</b>	HDMI_19P_R3660019-X02-R
<b>Description</b>	HDMI Conn. 19P 90D(M) DIP R3660019-X02-R
Pin	Pin Name
1	TMDS Data2+
2	TMDS Data2 Shield
3	TMDS Data2-
4	TMDS Data1+
5	TMDS Data1 Shield
6	TMDS Data1-
7	TMDS Data0+
8	TMDS Data0 Shield
9	TMDS Data0-
10	TMDS Clock+
11	TMDS Clock Shield
12	TMDS Clock-
13	Reserved
14	Reserved
15	SCL
16	SDA
17	GND
18	+5V Power
19	Hot Plug Detect

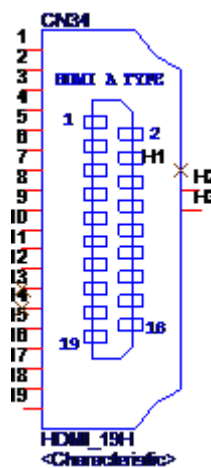

---

<b>CN36</b>	<b>System Fan</b>
Part Number	1655003010
Footprint	WHP3VA
Description	
Pin	Pin Name
1	GND
2	+V12
3	N/C

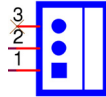

# Appendix **B**

## System Assignments

This appendix contains information of a detailed nature.

- System I/O Ports
- DMA Channel Assignments
- First MB Memory Map
- Interrupt Assignments

## B.1 System I/O Ports

**Table B.1: System I/O Ports**

Addr. Range (Hex)	Device
00-1F	DMA Controller
20-2D	Interrupt Controller
2E - 2F	Motherboard resources
4E - 4F	Motherboard resources
50-52	Timer/Counter
60-6F	8042 (keyboard controller)
70-7F	Real-time clock, non-maskable interrupt (NMI) mask
80-9F	DMA page register
A0-BF	Motherboard resources
C0-DF	DMA controller
299-29A	EC HM Index port and Data port
29C-29D	EC Index port and Data port
2F8-2FF	Communications Port (COM2)
3C0-3DF	Motherboard resources
3F8-3FF	Communications Port (COM1)
4D0-4D1	Motherboard resources

## B.2 DMA Channel Assignments

**Table B.2: DMA Channel Assignments**

Channel	Function
0	Available
1	Available
2	Available
3	Available
4	Direct memory access controller
5	Available
6	Available
7	Available

## B.3 First MB Memory Map

**Table B.3: First MB Memory Map**

Addr. Range (Hex)	Device
E0000h - FFFFFh	System board
D0000h - DFFFFh	PCI Bus
C0000h - CFFFFh	System board
A0000h - BFFFFh	PCI Bus
A0000h - BFFFFh	Intel® HD Graphic
00000h - 9FFFFh	System board

## B.4 Interrupt Assignments

**Table B.4: Interrupt Assignments**

<b>Interrupt#</b>	<b>Interrupt Source</b>
NMI	Parity error detected
IRQ0	System timer
IRQ1	Using SERIRQ, keyboard emulation
IRQ2	Interrupt from controller 2 (cascade)
IRQ3	Communications port (COM2)
IRQ4	Communications port (COM1)
IRQ5	EC Watch DOG
IRQ6	Available
IRQ7	Available
IRQ8	System CMOS/real time clock
IRQ9	Microsoft ACPI-compliant system
IRQ10	Available
IRQ11	SATA controller
IRQ12	Available
IRQ13	Numeric data processor
IRQ14	Reserved
IRQ15	Reserved

**ADVANTECH**

*Enabling an Intelligent Planet*

**[www.advantech.com](http://www.advantech.com)**

Please verify specifications before quoting. This guide is intended for reference purposes only.

All product specifications are subject to change without notice.

No part of this publication may be reproduced in any form or by any means, such as electronically, by photocopying, recording, or otherwise, without prior written permission from the publisher.

All brand and product names are trademarks or registered trademarks of their respective companies.

© Advantech Co., Ltd. 2019