

# R5000 Series

## R5050MG-08M-WGG02E



### Features

- Light-integrated design makes red/white/blue illumination optional, support control separately
- Support different focal lengths, electrical auto focus and one-click auto training
- GigE interface, IP65 protection level
- Abundant IO interfaces such as Ethernet, RS232, GPIO, support multiple communication protocols
- Support various code formats and evaluations of code quality
- Built-in deep-learning algorithms and multi-parameters polling to ensure effects of complex applications

### Dimensions (mm)

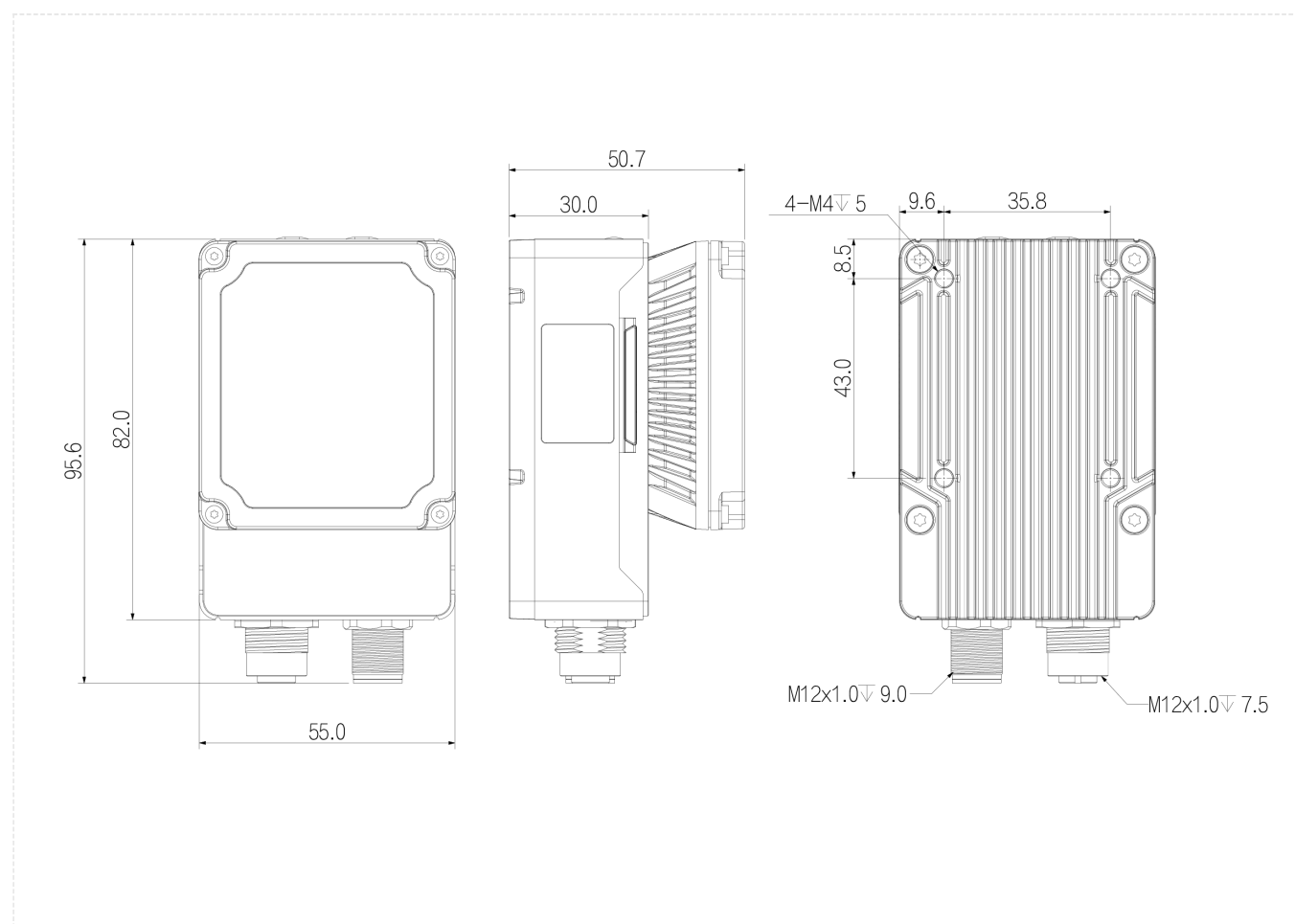













## Specification

Model		R5050MG-08M-WGG02E
Basic	Resolution	2368 × 1792
	Max. Frame rate	45 fps
	Shutter Mode	Global
	Mono/Color	Mono
	Lens Mount	M12
	Trigger Mode	Software trigger/External trigger/Free run modes, etc.
	Software	EasyID
	Certifications	CE , UKCA , KC
	Function	ID: Code 39/Code 93/Code128/CodaBar/EAN8/EAN13/UPCA/UPCE/ITF25/2of5 ( Industrial2of5 ) /standard25/GS1-128 etc. and 2D: Data Matrix/MQR/GS1 DM/GS1QR etc.; Quality Evaluation: ISO/IEC 29158(AIM-DPM), ISO/IEC 15415, ISO/IEC 15416 )
	Focal Length	8mm
	Light Source Type	White
Focus Control	auto focus	
Performance	Working Distance	80mm-1500mm
	Field of View (FOV)	216 mm×164 mm@WD200mm
	Max. Read Speed	90 codes/s
	Max. Operating Speed	3m/s
	Min. Resolution	1D code 0.04 mm/ 2D code 0.09 mm
Port	Connector	2 Industrial connectors support GigE and GPIO
	Network Port	GigE
	GPIO Interface	RS232, 2 Opto-isolated inputs and 3 Opto-isolated outputs
	Communication Mode	RS232, Ethernet
	Communication protocol	SDK , TCP Client , TCP Server , FTP , RS232 , Profinet、 Modbus、 EtherNet/IP、 MC(SLMP)、 FINS/UDP、 FINS/TCP
	LED Indicator	Power,Ethernet,Status,Result
Power	Power Supply	9~26VDC, 2A input, suitable for industrial environment
	Power Consumption	<18 W(light included)
Structure	Product Dimensions	82mm×55mm×50.7mm (not including connector)
	Net Weight	<350 g
	Protection	IP65
	Casing Material	Aluminum R5050MG-08M-WGG02;R5050MG-08M-RGG02;R5050MG-12M-WGG02;R5050MG-12M-RGG02;R5050MG-16M-WGG02;R5050MG-16M-RGG02;R5050MG-08M-WGG02E;R5050MG-08M-RGG02E;R5050MG-12M-WGG02E;R5050MG-12M-RGG02E;R5050MG-16M-WGG02E;R5050MG-16M-RGG02E;oy + Front cover

Environment	Operating Temperature	-20°C ~ +50°C
	Operating Humidity	20% ~ 95%(no condensation)
	Storage Temperature	-30°C ~ +70°C

## Connector Pin-out

### 12 pin-out on camera:

Pin	Signal	Description	Cable Color
1	OPT_OUT2	Opto-isolated output2	 Brown white
2	RS232_TXD	RS232 serial send	 Grey
3	RS232_RXD	RS232 serial receive	 Purple
4	SIGNAL_GND	RS232 serial GND	 Black white
5	OPT_IN1	Opto-isolated input1	 Yellow
6	OPT_IN_GND	Opto-isolated input GND	 Purple white
7	POWER	Power	 Red
8	POWER_GND	Power GND	 Black
9	OPT_OUT_GND	Opto-isolated output GND	 Green
10	OPT_IN0	Opto-isolated input0	 Orange
11	OPT_OUT0	Opto-isolated output0	 Blue
12	OPT_OUT1	Opto-isolated output1	 Brown
-	-	Shield GND	 White

