

NP-6132-L2

- Desktop High Performance CPU
- 4 x GbE LAN

■ Features

- Support Intel® Core™ 10th/11th generation i9/i7/i5/i3 high performance processors, Max. TDP 65W
- 4 x Intel GbE LAN controller
- 4 x USB3.0, USB2.0 Type A on board for dongle
- 2 x RS232/RS485, RS485 support auto flow control
- Support both DVI-D and HDMI display port
- DC12~24V Power supply with overcurrent, overvoltage and polarity inverse protection
- Support wall-mounted or DIN-Rail fixing style.
- Wide operating temperature -20 ~ 60°C supported



■ Specifications

Model Name		NP-6132-L2
System	CPU	Intel® Core™ 10th/11th gen i9/i7/i5/i3 LGA1200 type CPU
	TDP	Max. 65W
	BIOS	AMI UEFI 64Mbit
	Memory	2 x SO-DIMM DDR4, max up to 32GB
	Storage	1 x mSATA bay
		1 x M.2(B Key, Type 2280) bay support SATA
	USB	4 x USB3.0, 1 x USB2.0 Type A on the board for USB dongle
	COM	2 x COM(DB-9), selectable to support RS232 or RS485 mode by the switch, RS485 support auto flow control, (ESD protection for RS232: Air gap ±8KV, Contact ±6KV)
	Ethernet	4 x Intel GbE LAN controller
	DVI-D	Support up to 1920 x 1080 @60Hz
	HDMI	Support up to 3840 x 2160 @60Hz
Watch Dog	1~255 levels programmable	
OS Support	Microsoft Windows	Windows 10
	Linux	Ubuntu, CentOS, Debian
Power	Voltage Input	DC12~24V ±10%, overcurrent, overvoltage and polarity inverse protection
	Power Consumption	Max. 120W
Chassis	Structure	Aluminum-magnesium alloy BOX with fan embedded to assist cooling, Wall-mounted or DIN-Rail fixing style.
	Dimensions	(L)200mm x (W)154.5mm x (H)74.6mm
	Net Weight	2.0Kg
Environment	Work Temperature	-20°C ~ 60°C (-4°F~140°F) with air flow (SSD)
	Storage Temperature	-40°C ~ 80°C (-40°F ~ 176°F) with air flow (SSD)
	Relative Humidity	5~95% (Non-condensing)
	Operating Vibration	5~500Hz, 1.5Grms@with SSD, Follow IEC60068-2-64
	Operating Shock	20G peak acceleration(11ms duration) with SSD, Follow IEC60068-2-27
EMC	CE/FCC Class A	

■ Dimensions (Unit: mm)

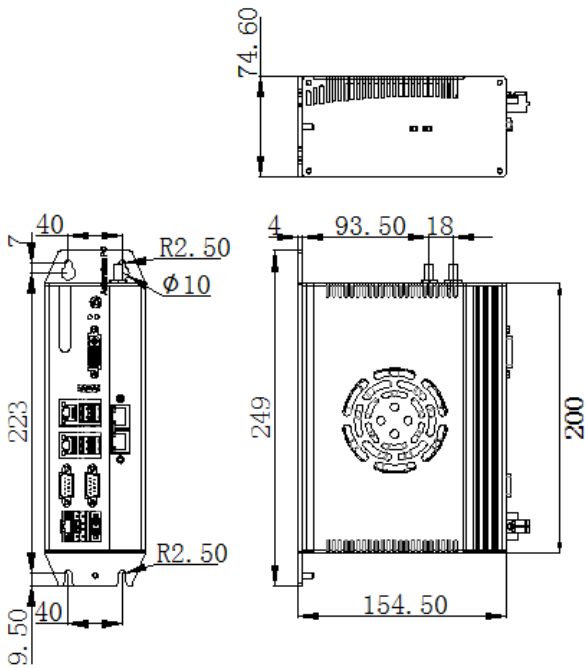

■ Interfaces

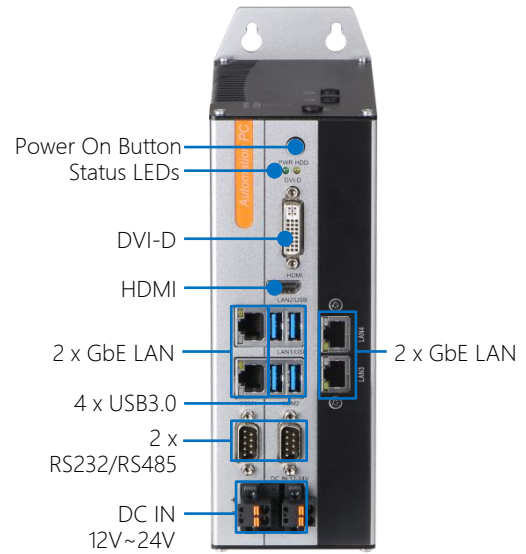

■ Ordering Information

Part No.	Product	Description
6070200249	NP-6132-L2	CPU:NULL, RAM:NULL, mSATA:NULL, M.2 SATA:NULL, 2 x RS232/485(Selectable), 4 x LAN, 4 x USB3.0, DVI-D/HDMI display port, DC12~24V Power input

■ Options

Parts	Description	
CPU	Intel® Core™ Comet lake	i3-10100T, i3-10100, i3-10105T, i3-10105, i5-10400T, i5-10400, i5-10500
	Intel® Core™ Rocket lake	i5-11400T, i5-11500T, i5-11600T, i5-11400, i5-11500, i5-11600
DDR4 Memory	4GB, 8GB, 16GB	
mSATA SSD	64GB, 128GB, 256GB, 512GB, 1TB	
M.2 SATA SSD	128GB, 256GB, 512GB, 1TB, 2TB	
Mount Option	DIN-Rail	

Note: If some optional parts are offered with the system, additional system certificates may be required in certain regions/countries. Please contact NODKA for certificate compliance.